

Automation systems Drive solutions

Controls

Inverter

Motors



Gearboxes

Engineering Tools

Motors: MCS synchronous servo motors, MCM synchronous servo motors, MD□KS synchronous servo motors, MQA asynchronous servo motors, MCA asynchronous servo motors

Contents of the L-force catalogue

About Lenze		Lenze makes many things easy for you. A matter of principle: the right products for every application. L-force product portfolio			
Automation systems		Controller-based Automation	1.1		
		Drive-based automation	1.2		
Drive solutions		HighLine tasks	2.1		
		StateLine tasks	2.2		
		Baseline tasks	2.3		
Controls	Visualisation	Panel PC v800	3.1		
		Monitor v200	3.2		
	Cabinet Controllers	Controller 3200 C	3.3		
		Controller c300	3.4		
	Panel Controllers	Controller p500	3.5		
		Controller p300	3.6		
		I/O System 1000	3.7		
Inverter	Decentralised	Inverter Drives 8400 protec	4.1		
		Inverter Drives 8400 motec	4.2		
	Cabinet	Servo Drives 9400 HighLine	4.3		
		Inverter Drives 8400 TopLine	4.4		
		Servo-Inverter i700	4.5		
		Inverter Drives 8400 HighLine	4.6		
		Inverter Drives 8400 StateLine	4.7		
		Inverter Drives 8400 Baseline	4.8		
Motors	Servo motors	MCS synchronous servo motors	5.1		
		MCM synchronous servo motors	5.2		
		MD□KS synchronous servo motors	5.3		
		MQA asynchronous servo motors	5.4		
		MCA asynchronous servo motors	5.5		
	Three-phase AC motors	IE3 three-phase AC motors m550-P	5.6		
		Inverter opt. three-phase AC motors MF	5.7		
		IE2 MH three-phase AC motors	5.8		
		IE1 MD three-phase AC motors	5.9		
		Lenze Smart Motor m300	5.10		
		IE3 three-phase AC motors m240-P	5.11		
		IE1/2 three-phase AC motors Basic MD/MH	5.12		
		Gearboxes	Axial gearboxes	g700-P planetary gearbox	6.1
				MPR/MPG planetary gearboxes	6.2
g500-H helical gearboxes	6.3				
g500-S shaft-mounted helical gearbox	6.4				
Right-angle gearboxes	g500-B bevel gearbox		6.5		
Motor data	Assignment see above		6.6		
Engineering Tools		Navigator	7.1		
		Drive Solution Designer	7.2		
		Drive Solution Catalogue	7.3		
		Engineer	7.4		
		PLC Designer	7.5		
		VisiWinNET®	7.6		
		EASY Starter	7.7		

 Selected portfolio
 Additional portfolio

Lenze makes many things easy for you.

With our motivated and committed approach, we work together with you to create the best possible solution and set your ideas in motion - whether you are looking to optimise an existing machine or develop a new one. We always strive to make things easy and seek perfection therein. This is anchored in our thinking, in our services and in every detail of our products. It's as easy as that!

1

Developing ideas

Are you looking to build the best machine possible and already have some initial ideas? Then get these down on paper together with us, starting with small innovative details and stretching all the way to completely new machines. Working together, we will develop an intelligent and sustainable concept that is perfectly aligned with your specific requirements.

2

Drafting concepts

We see welcome challenges in your machine tasks, supporting you with our comprehensive expertise and providing valuable impetus for your innovations. We take a holistic view of the individual motion and control functions here and draw up consistent, end-to-end drive and automation solutions for you - keeping everything as easy as possible and as extensive as necessary.

3

Implementing solutions

Our easy formula for satisfied customers is to establish an active partnership with fast decision making processes and an individually tailored offer. We have been using this principle to meet the ever more specialised customer requirements in the field of machine engineering for many years.

4

Manufacturing machines

Functional diversity in perfect harmony: as one of the few full-range providers in the market, we can provide you with precisely those products that you actually need for any machine task – no more and no less. Our L-force product portfolio, a consistent platform for implementing drive and automation tasks, is invaluable in this regard.

5

Ensuring productivity

Productivity, reliability and new performance peaks on a daily basis – these are our key success factors for your machine. After delivery, we offer you cleverly devised service concepts to ensure continued safe operation. The primary focus here is on technical support, based on the excellent application expertise of our highly-skilled and knowledgeable after-sales team.

A matter of principle: the right products for every application.

Lenze's extensive L-force product portfolio follows a very simple principle. The functions of our finely scaled products are assigned to the three lines Base-Line, State-Line or High-Line.

But what does this mean for you? It allows you to quickly recognise which products represent the best solution for your own specific requirements.

Powerful products with a major impact:

- Easy handling
- High quality and durability
- Reliable technologies in tune with the latest developments

Lenze products undergo the most stringent testing in our own laboratory. This allows us to ensure that you will receive consistently high quality and a long service life. In addition to this, five logistics centres ensure that the Lenze products you select are available for quick delivery anywhere across the globe. It's as easy as that!

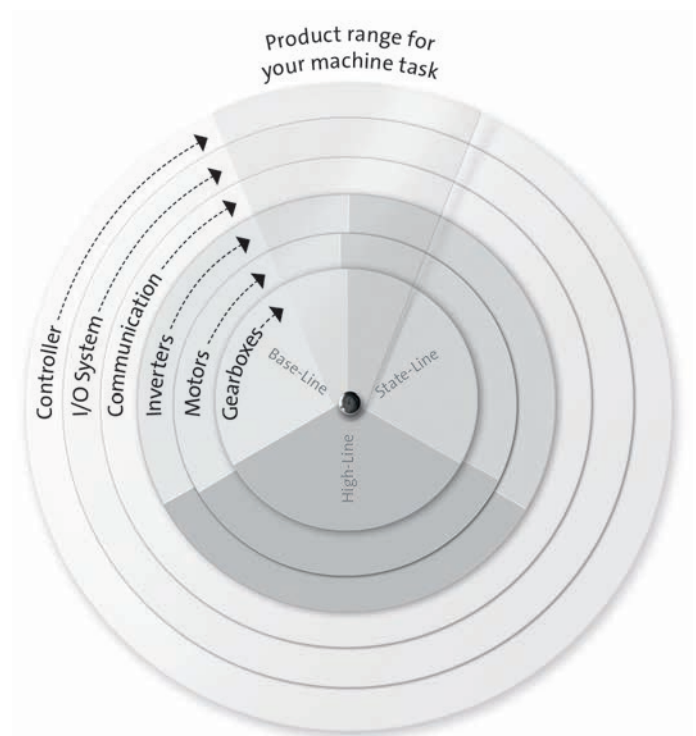

L-force product portfolio

Controls

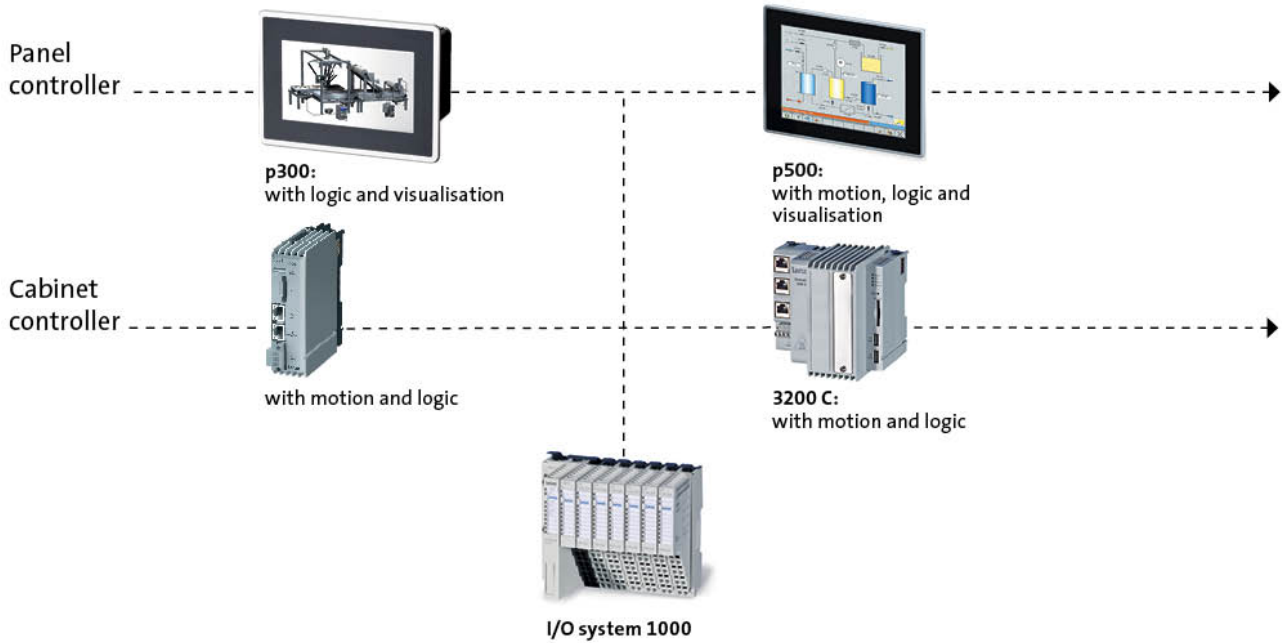

Engineering Tools

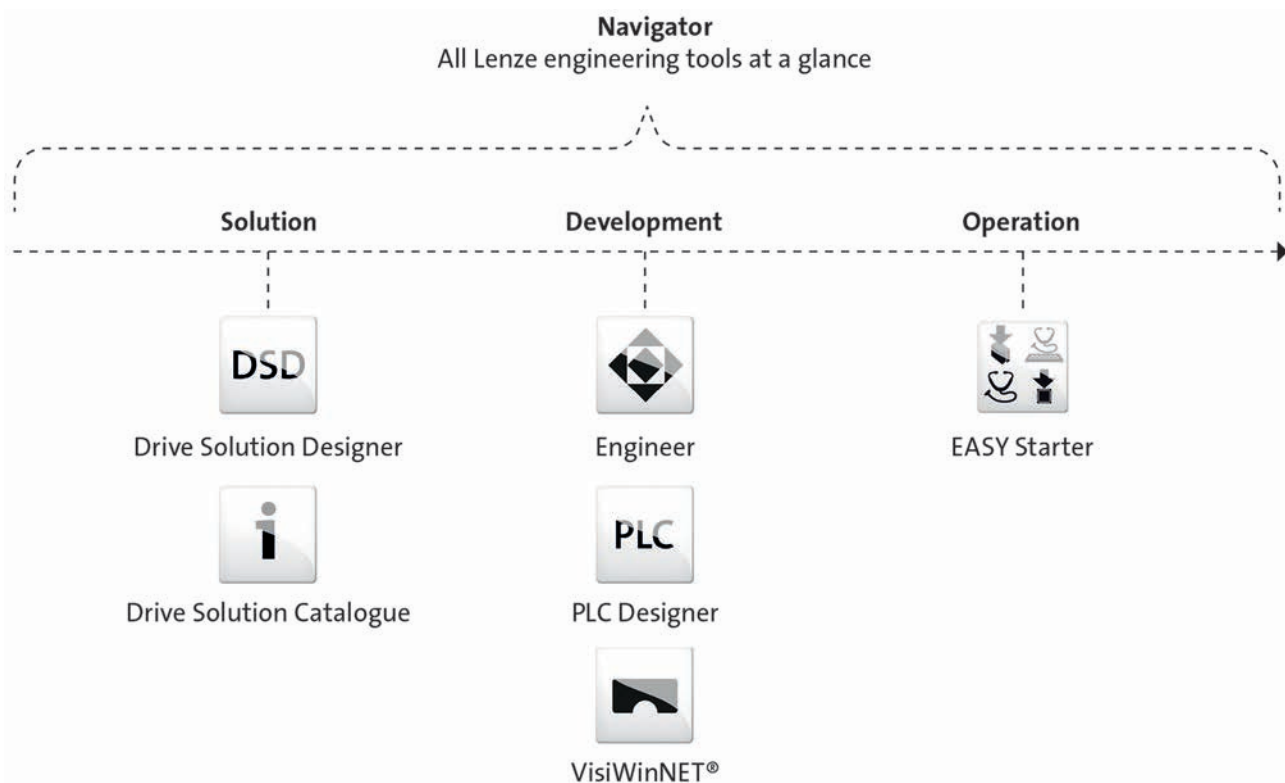

L-force product portfolio

Inverter

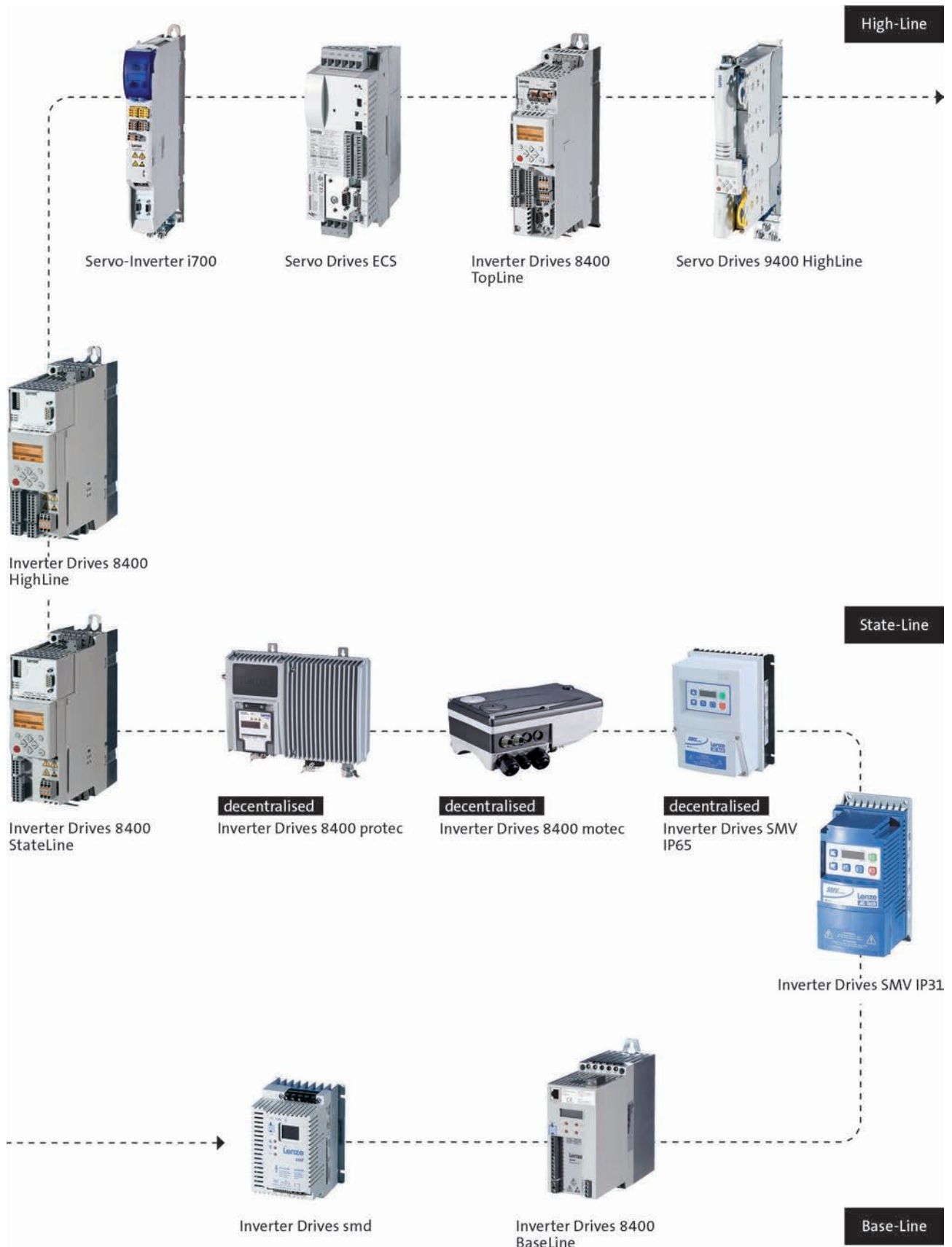

L-force product portfolio

Motors

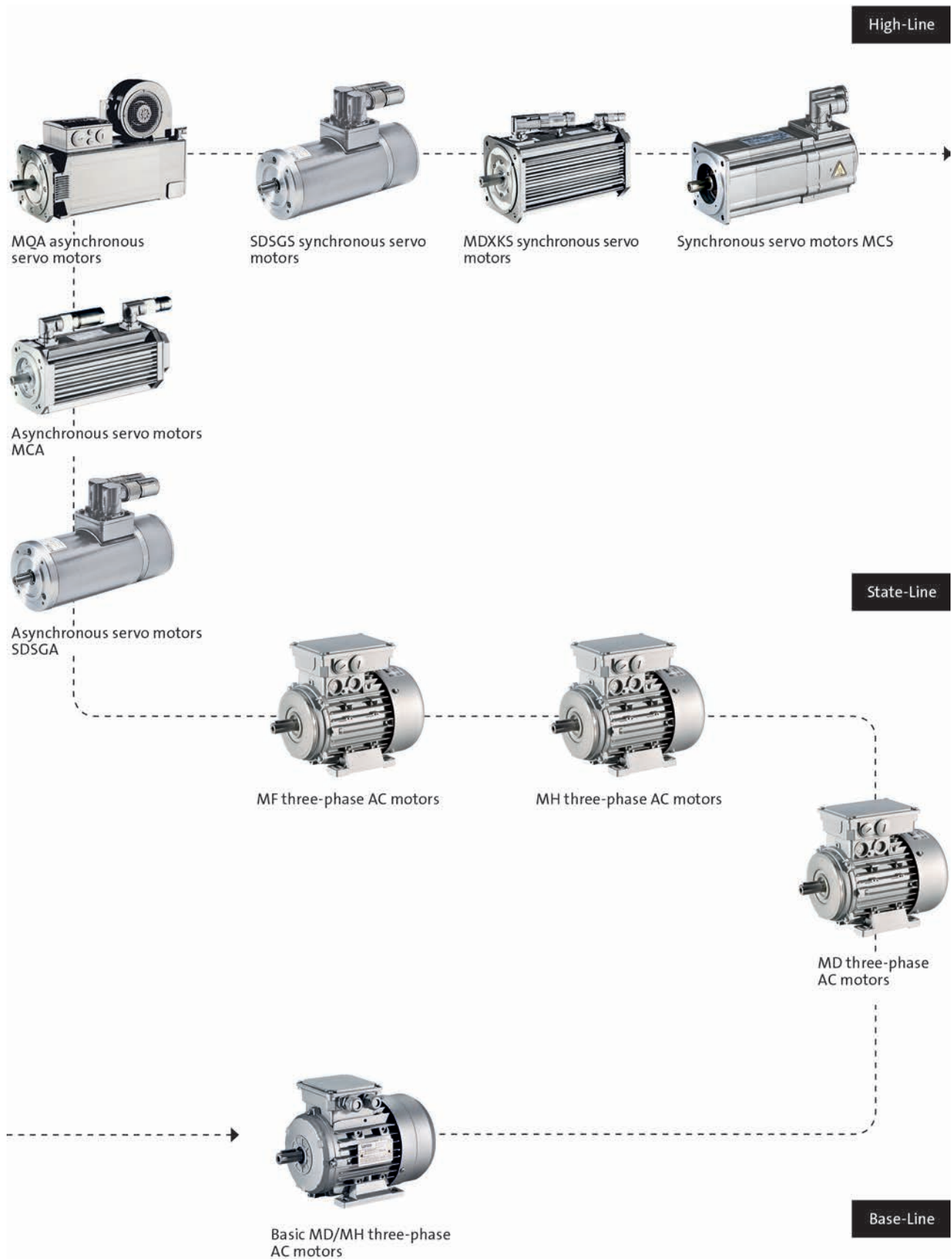

L-force product portfolio

Gearboxes

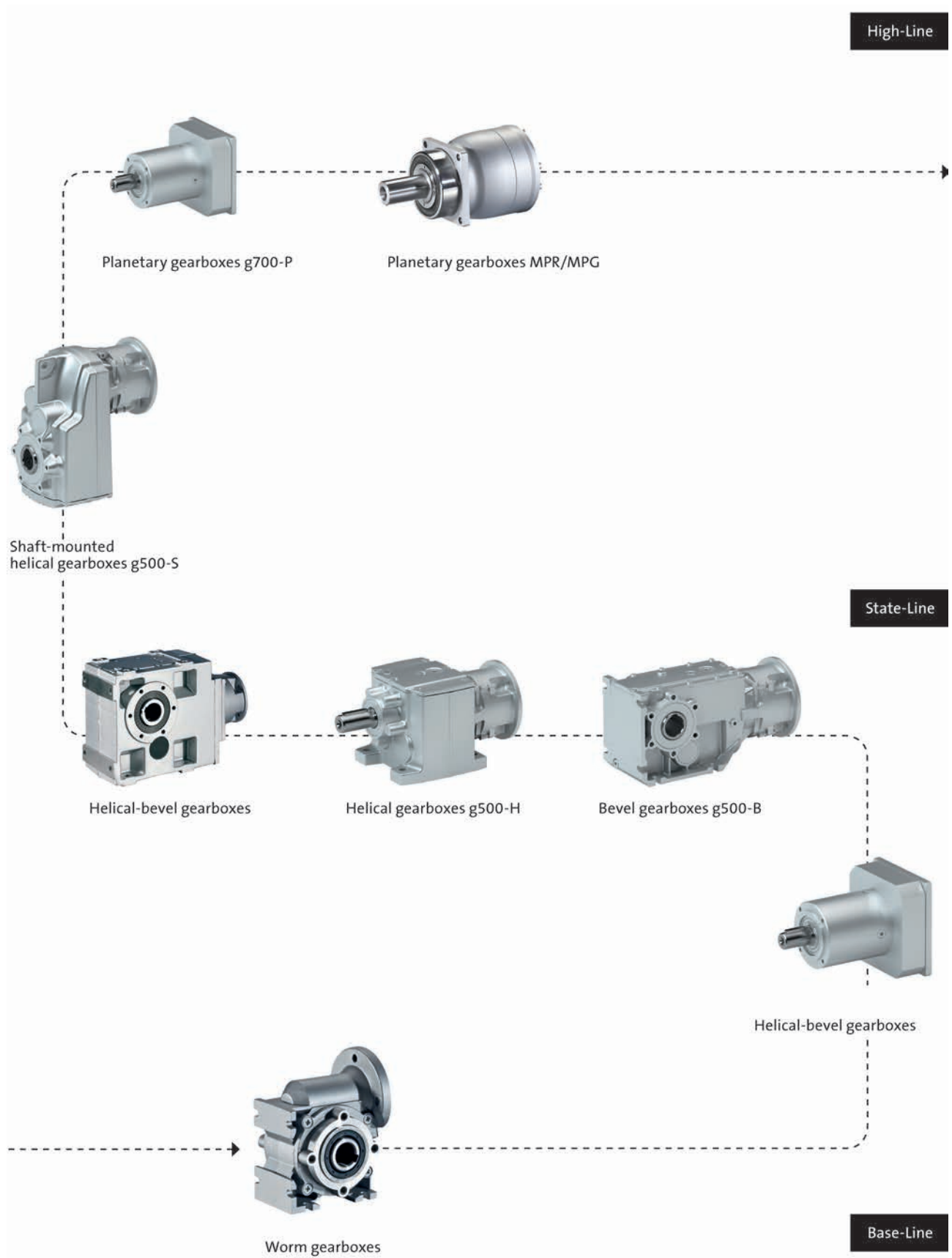

Motors

MCS synchronous servo motors

0.5 ... 190 Nm



MCS synchronous servo motors

Contents



General information	List of abbreviations	5.1 - 4
	Product key	5.1 - 6
	Product information	5.1 - 8
	Functions and features	5.1 - 9
	Dimensioning	5.1 - 10
Technical data	Standards and operating conditions	5.1 - 17
	Permissible radial and axial forces	5.1 - 18
	Rated data, non-ventilated	5.1 - 19
	Rated data, forced ventilated	5.1 - 24
	Selection tables, Servo Drives 9400 HighLine	5.1 - 26
	Selection tables, Inverter Drives 8400 TopLine	5.1 - 36
	Selection tables, Servo Drives ECS	5.1 - 47
	Selection tables, Servo Inverter 9300	5.1 - 56
	Torque characteristics	5.1 - 63
	Dimensions, self-ventilated	5.1 - 100
	Dimensions, forced ventilated	5.1 - 106
	Accessories	Permanent magnet holding brake
Resolver		5.1 - 111
Incremental encoder and SinCos absolute value encoder		5.1 - 112
Blower		5.1 - 114
Temperature monitoring		5.1 - 115
Terminal box		5.1 - 116
ICN connector	5.1 - 118	

MCS synchronous servo motors

General information



List of abbreviations

$\eta_{100\%}$	[%]	Efficiency
$\cos \phi$		Power factor
du/dt	[kV/ μ s]	Insulation resistance
$F_{ax,-}$	[N]	Min. axial force
$F_{ax,+}$	[N]	Max. axial force
$f_{in,max}$	[Hz]	Max. input frequency
f_{max}	[kHz]	Limit frequency
f_{max}	[kHz]	Max. switching frequency
f_N	[Hz]	Rated frequency
F_{rad}	[N]	Max. radial force
H_{max}	[m]	Site altitude
I_0	[A]	Standstill current
I_{max}	[A]	Max. short-time DC-bus current
I_{max}	[A]	Max. current
I_{max}	[A]	Max. current consumption
I_{max}	[A]	Max. current
I_{max}	[A]	Max. DC-bus current
I_N	[A]	Rated current
J	[kgcm ²]	Moment of inertia
J_{MB}	[kgcm ²]	Moment of inertia
$KE_{LL\ 150\ ^\circ C}$	[V/(1000 r/min)]	Voltage constant
$Kt_{0\ 150\ ^\circ C}$	[Nm/A]	Torque constant
L	[mH]	Mutual inductance
$L_{1\sigma}$	[mH]	Stator leakage inductance
$L_{2\sigma}$	[mH]	Rotor leakage inductance
L_N	[mH]	Rated inductance
m	[kg]	Mass
M_0	[Nm]	Stall torque
$M_{0,max}$	[Nm]	Max. standstill torque
M_{av}	[Nm]	Average dynamic torque
M_{max}	[Nm]	Max. torque
M_N	[Nm]	Rated torque
n_{eto}	[r/min]	Transition speed
n_k	[r/min]	Speed
n_{max}	[r/min]	Max. speed

n_N	[r/min]	Rated speed
P_N	[kW]	Rated power
Q_E	[J]	Maximum switching energy
R	[Ω]	Insulation resistance
R	[Ω]	Min. insulation resistance
R_1	[Ω]	Stator impedance
R_2	[Ω]	Charging resistor
R_2	[Ω]	Rotor impedance
$R_{UV\ 150\ ^\circ C}$	[Ω]	Stator impedance
$R_{UV\ 20\ ^\circ C}$	[Ω]	Stator impedance
$S_{h\u00fc}$	[1/h]	Transition operating frequency
T	[$^\circ C$]	Operating temperature
T	[$^\circ C$]	Rated temperature
T	[$^\circ C$]	Max. ambient temperature of bearing
T	[$^\circ C$]	Max. surface temperature
T	[$^\circ C$]	Max. ambient temperature for transport
T	[$^\circ C$]	Min. ambient storage temperature
T	[$^\circ C$]	Min. ambient temperature for transport
T	[$^\circ C$]	Ambient temperature
t_1	[ms]	Engagement time
t_2	[ms]	Disengagement time
$T_{opr,max}$	[$^\circ C$]	Max. ambient operating temperature
$T_{opr,min}$	[$^\circ C$]	Min. ambient operating temperature
$U_{in,max}$	[V]	Max. input voltage
$U_{in,min}$	[V]	Min. input voltage
U_{max}	[V]	Max. mains voltage
U_{max}	[V]	Min. input voltage
U_{min}	[V]	Min. mains voltage
$U_{N, AC}$	[V]	Rated voltage
$U_{N, DC}$	[V]	Rated voltage
Z_{ro}	[Ω]	Rotor impedance
Z_{rs}	[Ω]	Impedance
Z_{so}	[Ω]	Stator impedance

MCS synchronous servo motors

General information



List of abbreviations

CE	Communauté Européenne
CSA	Canadian Standards Association
DIN	Deutsches Institut für Normung e.V.
EMC	Electromagnetic compatibility
EN	European standard
EAC	Customs union Russia / Belarus / Kazakhstan certificate
IEC	International Electrotechnical Commission
IM	International Mounting Code
IP	International Protection Code
NEMA	National Electrical Manufacturers Association
UkrSEPRO	Certificate for Ukraine
UL	Underwriters Laboratory Listed Product
UR	Underwriters Laboratory Recognized Product
VDE	Verband deutscher Elektrotechniker (Association of German Electrical Engineers)

MCS synchronous servo motors

General information



Product key

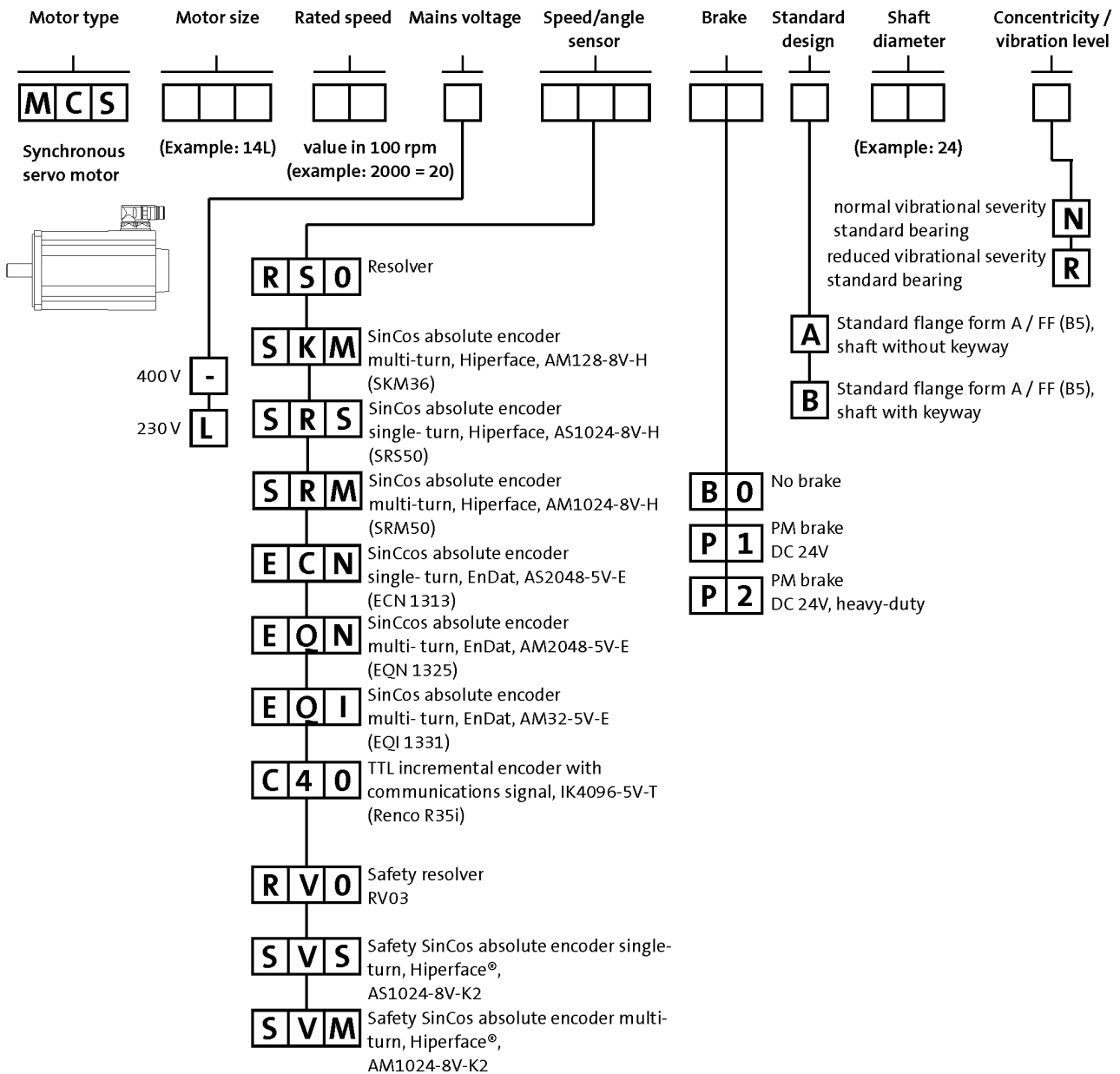

MCS synchronous servo motors

General information



Product key

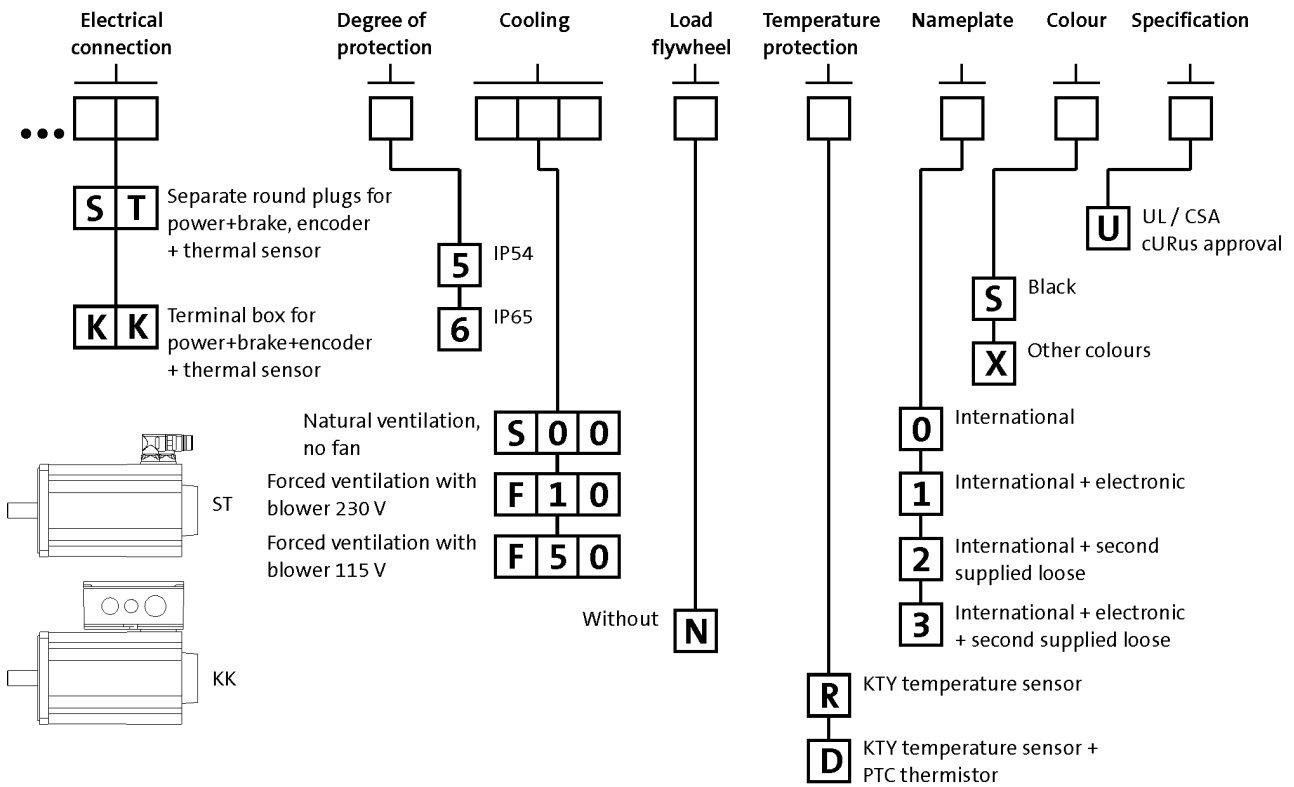

MCS synchronous servo motors

General information



Product information

When space is limited, but strict requirements in terms of dynamics and precision still have to be met, the MCS synchronous servo motors are the right choice.

With a power range from 0.25 kW to 15.8 kW and a rated torque range from 0.5 Nm to 72 Nm and peak torques of up to 190 Nm, these motors leave nothing to be desired in installations requiring compact and dynamic drive technology.

The stator winding of the MCS motors employs innovative Single Element Pole Technology – SEPT – and is made up of individual coils. High-quality magnetic materials and specially developed pole shapes set the conditions for their excellent drive characteristics. This results in a significant increase in power density, while at the same time reducing moments of inertia. The minimum detent torques offer exceptional smooth running characteristics and thereby secure excellent control behaviour.

The robust mechanical structure with reinforced bearings, the high degree of protection and the full stator encapsulation increase operational reliability, even in harsh ambient conditions.

Advantages

- High dynamic performance thanks to low moments of inertia
- Compact size with high power density
- Cooling with or without axial external fan
- Robust regenerative resolver system as standard
- Alternatively sin/cos encoder for the highest precision
- Easy to install and service friendly thanks to use of SpeedTec connectors
- Optional terminal box
- Protection: IP54, IP65 optional
- cURus-approved, GOST-certified, CE, RoHS compliant
- Smooth surface
- Single Element Pole Technology
- Optimum rotation characteristics
- Virtually free of detent torque
- Electronic nameplate



MCS09 synchronous servo motor

5.1

MCS synchronous servo motors

General information



Functions and features

	MCS06	MCS09	MCS12	MCS14	MCS19
Design					
	B5-FF75	B5-FF100	B5-FF130	B5-FF165	B5-FF215
Shaft end (with and without keyway)					
	11 x 23	14 x 30	19 x 40	24 x 50	28 x 60
A end shield	Not oil-tight				
Brake	DC 24 V				
Permanent magnetic brake	DC 24 V	DC 24 V 24 V DC, reinforced			
Speed and angle encoder	Resolver SinCos single-turn/multi-turn				
Cooling	Naturally ventilated				
Without blower	Naturally ventilated				
Axial blower, 1 phase					230 V; 50 Hz 115 V; 60 Hz
Temperature sensor	KTY				
Thermal detector	KTY				
PTC thermistor	2x PTC additional (3-phase monitoring)				
Motor connection: plug connector	Power + brake Encoder + thermal sensor		Power + brake Encoder + thermal sensor Blower		
Motor connection: terminal box	Power + brake + encoder + thermal sensor				
Shaft bearings	Deep-groove ball bearing with high-temperature resistant grease, sealing disc or cover plate				
Bearing type	Deep-groove ball bearing with high-temperature resistant grease, sealing disc or cover plate				
Position of the locating bearing	Non-drive end				
Colour	RAL9005M				

► Terminal boxes not possible if blower is fitted.

MCS synchronous servo motors



General information

Dimensioning

Speed-dependent safety functions

Single encoder concepts with resolvers

Servo motors can perform speed-dependent safety functions for safe speed and / or safe relative position monitoring in a drive system with the Servo Drives 9400. The SM301 safety module, which can be integrated in the Servo Drives 9400, is used to implement these functions. When planning systems/installations of this kind, the following must always be observed:

When using just one single feedback system in the environment of these safety applications, the applicable safety engineering standard IEC 61800-5-2 [Adjustable speed electrical power drive systems - Part: 5-2: Safety requirements - Functional] stipulates special requirements for the connection between feedback system and motor shaft. This is due to the fact that two-channel safety systems at this point in the mechanical system are actually designed as single-channel systems. If this mechanical connection is designed with considerable overdimensioning, the standard permits exclusion of the fault "encoder-shaft breakage" or "encoder-shaft slip". As such, acceleration limit values must not be exceeded for the individual drive solutions. You can find the limit values in the corresponding feedback data of the individual motor ranges.

Speed-dependent safety functions in connection with the SM301 safety module

For the following speed-dependent safety functions, the motor-feedback system combinations listed in the following table are available:

- Safe stop 1 (SS1)
- Safe operational stop (SOS)
- Safely Limited Speed (SLS)
- Safe Maximum Speed (SMS)

- Safe direction (SDI)
- Operation mode selector (OMS) with confirmation (ES)
- Safe speed monitor (SSM)
- Safely limited increment (SLI).

5.1

Encoder type	Encoder type	Product key	Feedback Design	Safe speed monitoring
SinCos absolute value	Single-turn	AS1024-8V-K2	2-encoder concept	PL d/SIL 2
	Multi-turn	AM1024-8V-K2		PL e/SIL 3
Resolver		RV03		up to PL e / SIL 3

MCS synchronous servo motors



General information

Dimensioning

Cooling effect of mounting flange

Mounting on a thermally conducting / insulating plate or machine chassis has an influence on heating up the motor, particularly when using naturally ventilated motors.

The motor rating data specified in the catalogue applies when mounting on a steel plate with free convection with the following dimensions:

- MCS06: 270 x 270 mm
- MCS09: 330 x 330 mm
- MCS12 / 14 / 19: 450 x 450 mm

Vibrational severity

		MCS06	MCS09	MCS12	MCS14	MCS19
Vibrational severity						
IEC/EN 60034-14				A		
Maximum r.m.s. value of the vibration velocity ¹⁾	[mm/s]			1.60		

¹⁾ Free suspension

- ▶ at n = 600 to 3,600 rpm



Dimensioning

Concentricity and axial run-out of the mounting flanges and smooth running of the shaft ends

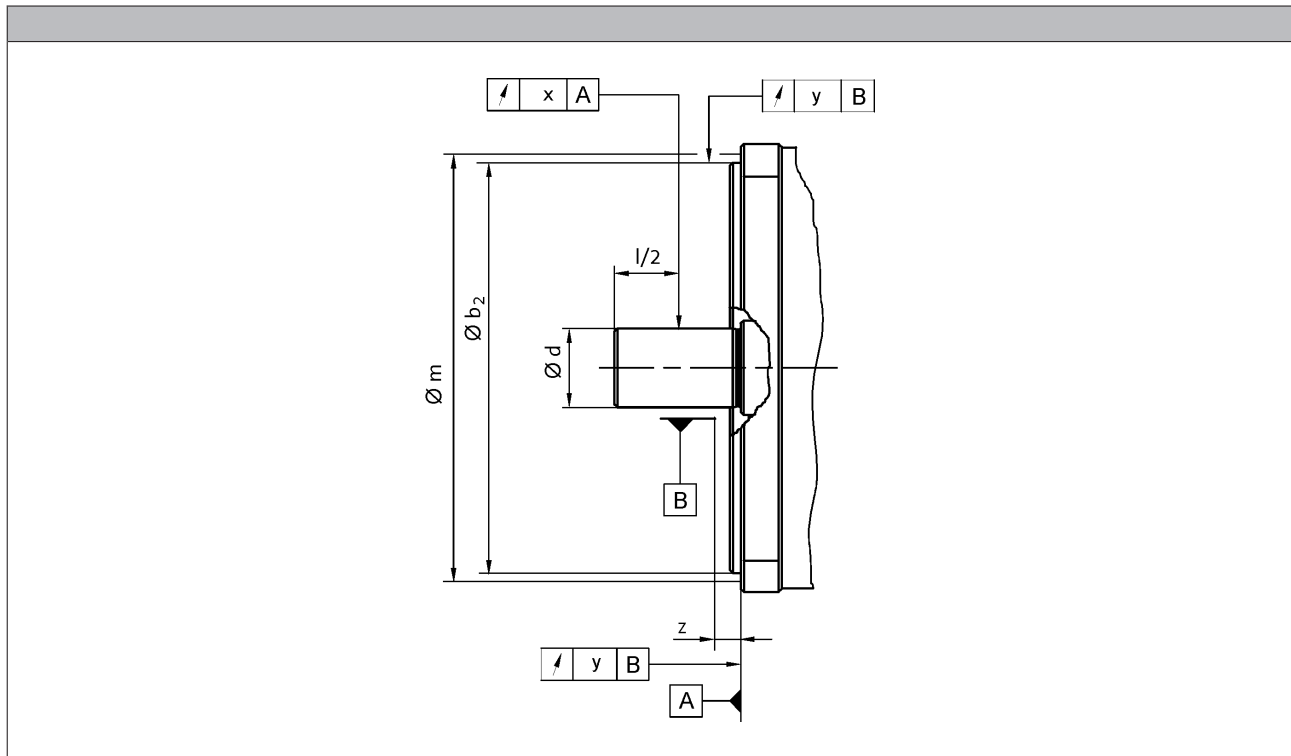

5.1

				MCS06	MCS09	MCS12	MCS14	MCS19
Flange size				FF75	FF100	FF130	FF165	FF215
Dimensions								
	b_2	j_6	[mm]	60	80	110	130	180
	d	k_6	[mm]	11	14	19	24	28
Distance								
Measuring diameter	m		[mm]	65.0	85.0	115	135	185
Dial gauge holder for flange check	z	± 1	[mm]	10.0				
Concentricity				Normal class				
IEC 60072				0.080			0.10	
Value	y		[mm]	0.080			0.10	
Axial run-out				Normal class				
IEC 60072				0.080			0.10	
Value	y		[mm]	0.080			0.10	
Smooth running				Normal class				
IEC 60072				0.035			0.040	
Value	x		[mm]	0.035			0.040	

- Limit values for checking the smooth running of the shaft ends as well as the concentricity and axial run-out of the mounting flange to IEC 60072

MCS synchronous servo motors

General information



Dimensioning

Notes on the selection tables

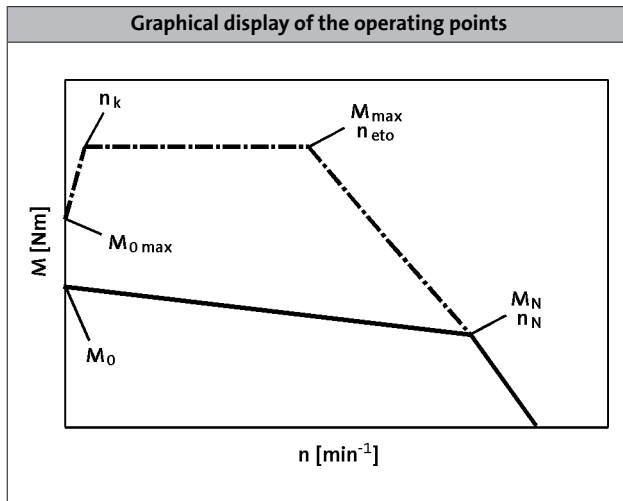

Please note:

- In case of an active load (e.g. vertical drive axes, hoists, test benches, unwinders), $M_{0\max}$ has to be considered
- In case of a passive load (e.g. horizontal drive axes), M_{\max} can be usually used
- In case of a speed $< n_k$ and inverter-specifically, the achievable torque $M_{0\max}$ is smaller than M_{\max}
- In case of a speed $n = 0$, the standstill torque M_0 and the standstill current I_0 have to be reduced by 30% after 2 seconds. In case of applications which require a longer holding of M_0 , we recommend the drive to be held via the holding brake and reduce the current, e.g. by controller inhibit.
- In case of servo inverters, the switching frequency dependent overload capacity is considered in the default setting. For more information, see the servo inverter catalogue.

	n_k [r/min]
MCS	75.0
MDSKS	100
MDFKS	

Further selection tables with different switching frequencies are available with the following codes:

- DS_ZT_MCS_0001
- DS_ZT_MCA_0001
- DS_ZT_MDSKS_0001
- DS_ZT_MDFKS_0001

Simply enter this code (e.g. DS_ZT_MCS_0001) as a search string at www.lenze.de/dsc and you will be given the information immediately in the form of a PDF format.

MCS synchronous servo motors

General information



Dimensioning

Notes on the torque characteristics

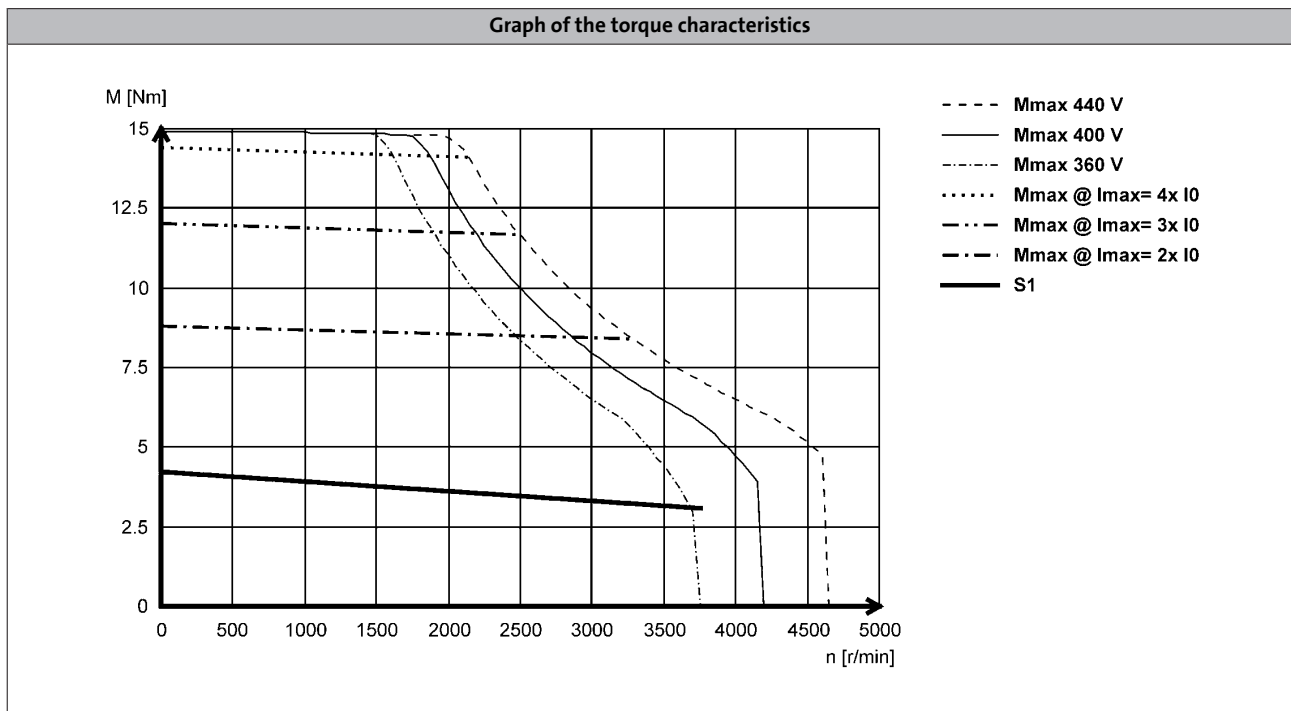

5.1

With synchronous servo motors, the limit torque characteristics that result from the selection of servo inverters with maximum currents are also shown alongside the characteristics for continuous operation (S1). These correspond to a multiple of the motor standstill current ($2 \times I_0$ to $4 \times I_0$).

Characteristics in the Internet

Torque characteristics for selectable motor/inverter combinations can be determined in the EASY Product Finder in the Internet. The S1 continuous characteristic and the max. limit characteristic are generated. The result can be saved or printed in a PDF protocol. In the EASY Explorer, available torque characteristics are provided automatically.

Further information on the terms switching frequency and default setting can be found in the respective operating instructions of the servo inverter.

MCS synchronous servo motors

General information



Dimensioning

Influence of ambient temperature and site altitude

The information relating to the servo motors in the tables and graphs is valid for a maximum ambient temperature (T_{opr}) of 40 °C and a site altitude (H) up to 1000 m above sea level. The torque correction factor (k_{M1}) shall be applied to the S1 torque characteristic ($M_0...M_N$) in the event of differing installation conditions.

- The maximum permissible ambient temperature (T_{opr}) for servo motors with blowers is 40 °C

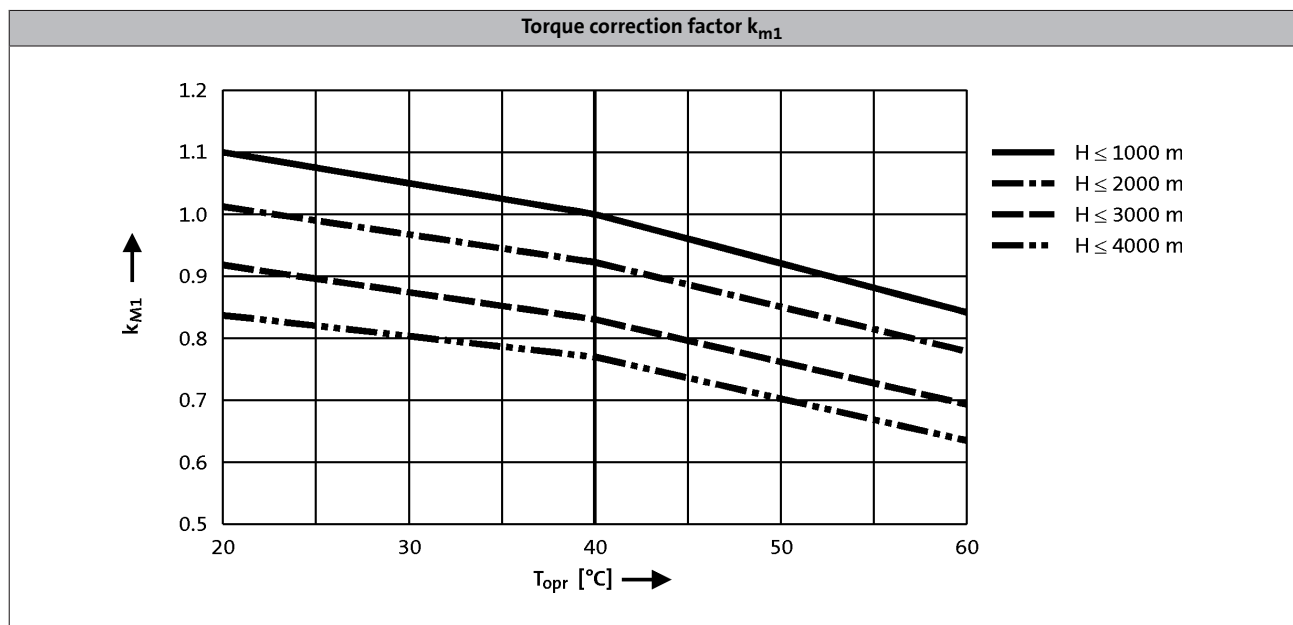

MCS synchronous servo motors

General information



MCS synchronous servo motors

Technical data



Standards and operating conditions

			MCS	
Cooling type			Naturally ventilated	Blower
Degree of protection				
EN 60529			IP54 IP65	IP54
Temperature class				
IEC/EN 60034-1; utilisation			F	
IEC/EN 60034-1; insulation system (enamel-insulated wire)			H	
Conformity				
CE			Low-Voltage Directive 2006/95/EC	
EAC			TP TC 004/2011 (TR CU 004/2011)	
Approval				
			UkrSEPRO	
CSA			CSA 22.2 No. 100	
cURus			UL 1004-1 UL 1004-6 Power Conversion Equipment (File-No. E210321)	
Max. voltage load				
IEC/TS 60034-25			Pulse voltage limiting curve A	
Smooth running				
IEC 60072			Normal class	
Axial run-out				
IEC 60072			Normal class	
Concentricity				
IEC 60072			Normal class	
Mechanical ambient conditions (vibration)				
IEC/EN 60721-3-3			3M6	
Min. ambient operating temperature				
Without brake	$T_{opr,min}$	[°C]	-20	-15
With brake	$T_{opr,min}$	[°C]	-10	
Max. ambient operating temperature				
	$T_{opr,max}$	[°C]	40	
Max. surface temperature				
	T	[°C]	140	110
Mechanical tolerance				
Flange centring diameter			$b_2 \leq 230 \text{ mm} = j6$ $b_2 > 230 \text{ mm} = h6$	
Shaft diameter			$d \leq 50 \text{ mm} = k6$ $d > 50 \text{ mm} = m6$	
Site altitude				
Amsl	H_{max}	[m]	4000	

5.1



Permissible radial and axial forces

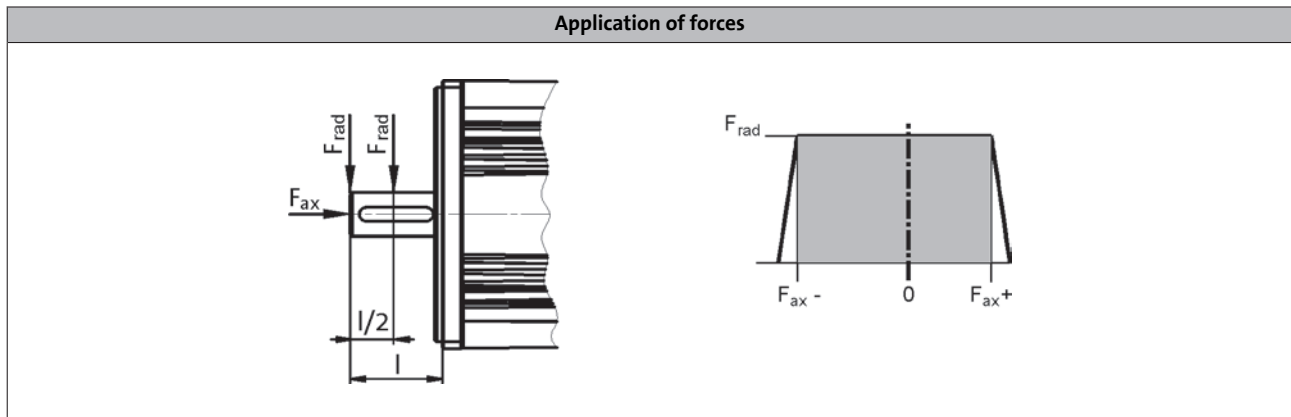

Application of force at $l/2$

	Bearing service life L_{10}														
	5000 h			10000 h			20000 h			30000 h			50000 h		
	F_{rad}	$F_{ax,-}$	$F_{ax,+}$	F_{rad}	$F_{ax,-}$	$F_{ax,+}$	F_{rad}	$F_{ax,-}$	$F_{ax,+}$	F_{rad}	$F_{ax,-}$	$F_{ax,+}$	F_{rad}	$F_{ax,-}$	$F_{ax,+}$
	[N]	[N]	[N]	[N]	[N]	[N]	[N]	[N]	[N]	[N]	[N]	[N]	[N]	[N]	[N]
MCS06	740	-260	140	590	-210	80	470	-170	40	410	-150	30	340	-140	10
MCS09	1040	-700	470	830	-550	310	660	-440	200	580	-380	150	490	-330	90
MCS12	1030	-880	560	820	-690	370	650	-550	230	570	-490	160	480	-420	100
MCS14	1830	-1150	720	1450	-900	470	1150	-720	290	1010	-640	200	850	-550	120
MCS19	3840	-1550	950	3050	-1210	620	2430	-960	360	2120	-840	250	1790	-730	130

5.1

Application of force at l

	Bearing service life L_{10}														
	5000 h			10000 h			20000 h			30000 h			50000 h		
	F_{rad}	$F_{ax,-}$	$F_{ax,+}$	F_{rad}	$F_{ax,-}$	$F_{ax,+}$	F_{rad}	$F_{ax,-}$	$F_{ax,+}$	F_{rad}	$F_{ax,-}$	$F_{ax,+}$	F_{rad}	$F_{ax,-}$	$F_{ax,+}$
	[N]	[N]	[N]	[N]	[N]	[N]	[N]	[N]	[N]	[N]	[N]	[N]	[N]	[N]	[N]
MCS06	630	-210	90	500	-170	50	400	-140	20	350	-130	0	290	-120	-10
MCS09	900	-630	400	710	-500	260	570	-400	160	500	-350	120	420	-300	70
MCS12	890	-820	490		-640	320	560	-520	190	490	-460	130		-400	
MCS14	1590	-1040	610	1260	-820	390	1000	-660	230	880	-580	150	740	-510	
MCS19	3330	-1320	730	2650	-1040	450	2100	-830	240	1840	-740	140	1550	-640	40

- The values for the bearing service life L_{10} refer to an average speed of 4000 r/min. Depending on the ambient temperatures, the service life of the bearings is also reduced by the grease lifetime.

MCS synchronous servo motors

Technical data



Rated data, non-ventilated

► The data applies to a mains connection voltage of 3 x 400 V.

	n_N [r/min]	M_0 [Nm]	M_N [Nm]	M_{max} [Nm]	P_N [kW]	I_0 [A]	I_N [A]	I_{max} [A]	$U_{N, AC}$ [V]	f_N [Hz]
MCS06C41-	4050	0.80	0.60	2.40	0.25	1.30	1.30	5.40	225	270
MCS06C60-	6000	0.80	0.50	2.40	0.31	2.50	2.40	10.8	135	400
MCS06F41-	4050	1.50	1.20	4.40	0.51	1.50	1.50	5.30	320	270
MCS06F60-	6000	1.50	0.90	4.40	0.57	2.90	2.50	10.5	180	400
MCS06I41-	4050	2.00	1.50	6.20	0.64	1.70	1.60	5.90	325	270
MCS06I60-	6000	2.00	1.20	6.20	0.75	3.40	2.90	11.8	190	400
MCS09D41-	4050	3.30	2.30	9.50	1.00	2.60	2.30	10.0	320	270
MCS09D60-	6000	3.30	1.80	9.50	1.10	5.30	3.80	20.0	210	400
MCS09F38-	3750	4.20	3.10	15.0	1.20	3.00	2.50	15.0	330	250
MCS09F60-	6000	4.20	2.40	15.0	1.50	6.00	4.50	30.0	230	400
MCS09H41-	4050	5.50	3.80	20.0	1.60	4.30	3.40	20.0	300	270
MCS09H60-	6000	5.50	3.00	20.0	1.90	8.50	6.00	40.0	190	400
MCS09L41-	4050	7.50	4.50	32.0	1.90	6.20	4.20	32.0	295	270
MCS09L51-	5100	7.50	3.60	32.0	1.90	12.4	6.90	64.0	180	340

	$\eta_{100\%}$ [%]	$J^{1)}$ [kgcm ²]	$KE_{LL 150\text{ }^\circ\text{C}}$ [V/(1000 r/min)]	$R_{UV 20\text{ }^\circ\text{C}}$ [Ω]	$R_{UV 150\text{ }^\circ\text{C}}$ [Ω]	L_N [mH]	$Kt_{0 150\text{ }^\circ\text{C}}$ [Nm/A]	$n_{max}^{2)}$ [r/min]	$m^{1)}$ [kg]
MCS06C41-	65.0	0.14	36.6	27.1	36.5	51.0	0.66	8000	1.80
MCS06C60-	70.0	0.14	18.3	6.80	9.10	12.8	0.33	8000	1.80
MCS06F41-	77.0	0.22	60.1	21.9	29.5	63.5	1.05	8000	2.20
MCS06F60-	81.0	0.22	30.0	5.50	7.40	15.9	0.53	8000	2.20
MCS06I41-	81.0	0.30	73.4	18.8	25.4	60.2	1.21	8000	2.90
MCS06I60-	84.0	0.30	36.7	4.70	6.30	15.1	0.60	8000	2.90
MCS09D41-	87.0	1.10	71.2	7.00	9.40	25.1	1.25	7000	4.30
MCS09D60-	87.0	1.10	35.6	1.80	2.40	6.30	0.62	7000	4.30
MCS09F38-	91.0	1.50	79.8	5.20	7.00	24.6	1.40	7000	5.20
MCS09F60-	91.0	1.50	39.9	1.30	1.80	6.20	0.70	7000	5.20
MCS09H41-	91.0	1.90	75.7	3.20	4.30	16.1	1.29	7000	6.10
MCS09H60-	91.0	1.90	37.8	0.80	1.10	4.00	0.65	7000	6.10
MCS09L41-	91.0	2.80	71.7	1.80	2.40	9.90	1.21	7000	7.90
MCS09L51-	91.0	2.80	35.9	0.44	0.59	2.50	0.60	7000	7.90

¹⁾ Without brake.

²⁾ Mechanically permissible maximum speed.

MCS synchronous servo motors

Technical data



Rated data, non-ventilated

► The data applies to a mains connection voltage of 3 x 400 V.

	n_N [r/min]	M_0 [Nm]	M_N [Nm]	M_{max} [Nm]	P_N [kW]	I_0 [A]	I_N [A]	I_{max} [A]	$U_{N, AC}$ [V]	f_N [Hz]
MCS12D20-	1950	6.40	5.50	18.0	1.10	2.70	2.60	10.0	345	130
MCS12D41-	4050	6.40	4.30	18.0	1.80	5.50	4.50	20.0	310	270
MCS12H15-	1500	11.4	10.0	29.0	1.60	4.10	3.80	12.0	300	100
MCS12H35-	3525	11.4	7.50	29.0	2.80	8.20	5.70	24.0	325	235
MCS12L20-	1950	15.0	13.5	56.0	2.80	6.20	5.90	28.0	330	130
MCS12L41-	4050	15.0	11.0	56.0	4.70	12.4	10.2	57.0	300	270
MCS14D15-	1500	11.0	9.20	29.0	1.45	5.00	4.50	17.0	305	100
MCS14D36-	3600	11.0	7.50	29.0	2.80	10.0	7.50	33.0	295	240
MCS14H15-	1500	21.0	16.0	55.0	2.50	8.50	6.60	26.0	325	100
MCS14H32-	3225	21.0	14.0	55.0	4.70	16.9	11.9	52.0	295	215
MCS14L15-	1500	28.0	23.0	77.0	3.60	12.0	9.70	37.0	315	100
MCS14L32-	3225	28.0	17.2	77.0	5.80	24.0	15.0	75.0	275	215
MCS14P14-	1350	37.0	30.0	105	4.20	12.2	10.8	46.0	340	90
MCS14P32-	3225	37.0	21.0	105	7.10	24.3	15.6	92.0	315	215

	$\eta_{100\%}$ [%]	$J^{1)}$ [kgcm ²]	$KE_{LL 150\text{ °C}}$ [V / (1000 r/min)]	$R_{UV 20\text{ °C}}$ [Ω]	$R_{UV 150\text{ °C}}$ [Ω]	L_N [mH]	$Kt_{0 150\text{ °C}}$ [Nm/A]	$n_{max}^{2)}$ [r/min]	$m^{1)}$ [kg]
MCS12D20-	79.0	4.00	137	8.70	11.8	52.2	2.34	6000	6.40
MCS12D41-	84.0	4.00	68.6	2.20	2.90	13.0	1.17	6000	6.40
MCS12H15-	88.0	7.30	173	5.70	7.70	42.1	2.79	6000	9.50
MCS12H35-	91.0	7.30	86.5	1.40	1.90	10.5	1.40	6000	9.50
MCS12L20-	90.0	10.6	149	2.20	3.00	21.8	2.42	6000	12.6
MCS12L41-	91.0	10.6	74.6	0.55	0.75	5.50	1.21	6000	12.6
MCS14D15-	88.0	8.10	129	4.00	5.40	49.8	2.19	6000	10.7
MCS14D36-	92.0	8.10	64.2	1.00	1.35	12.5	1.09	6000	10.7
MCS14H15-	92.0	14.2	153	2.08	2.81	34.1	2.48	6000	15.5
MCS14H32-	93.0	14.2	76.3	0.52	0.70	8.50	1.24	6000	15.5
MCS14L15-	90.0	23.4	152	1.21	1.64	22.0	2.33	6000	20.1
MCS14L32-	93.0	23.4	76.2	0.30	0.41	5.50	1.16	6000	20.1
MCS14P14-	90.0	34.7	179	1.10	1.49	23.9	3.04	6000	24.9
MCS14P32-	93.0	34.7	89.4	0.28	0.37	6.00	1.52	6000	24.9

¹⁾ Without brake.

²⁾ Mechanically permissible maximum speed.

MCS synchronous servo motors

Technical data



Rated data, non-ventilated

► The data applies to a mains connection voltage of 3 x 400 V.

	n_N [r/min]	M_0 [Nm]	M_N [Nm]	M_{max} [Nm]	P_N [kW]	I_0 [A]	I_N [A]	I_{max} [A]	$U_{N, AC}$ [V]	f_N [Hz]
MCS19F14-	1425	32.0	27.0	86.0	4.00	9.90	8.60	31.0	335	95
MCS19F30-	3000	32.0	21.0	86.0	6.60	19.8	14.0	63.0	300	200
MCS19J14-	1425	51.0	40.0	129	6.00	15.2	12.3	45.0	330	95
MCS19J30-	3000	51.0	29.0	129	9.10	30.5	18.5	90.0	300	200
MCS19P14-	1350	64.0	51.0	190	7.20	17.5	14.3	60.0	330	90
MCS19P30-	3000	64.0	32.0	190	10.0	34.9	19.0	120	320	200

	$\eta_{100\%}$ [%]	J^1 [kgcm ²]	$KE_{LL 150\text{ °C}}$ [V / (1000 r/min)]	$R_{UV 20\text{ °C}}$ [Ω]	$R_{UV 150\text{ °C}}$ [Ω]	L_N [mH]	$Kt_{0 150\text{ °C}}$ [Nm/A]	n_{max}^2 [r/min]	m^1 [kg]
MCS19F14-	92.0	65.0	195	1.30	1.75	20.8	3.23	4000	23.0
MCS19F30-	93.0	65.0	97.2	0.32	0.44	5.20	1.62	4000	23.0
MCS19J14-	92.0	105	199	0.65	0.88	12.8	3.31	4000	30.0
MCS19J30-	93.0	105	99.5	0.16	0.22	3.20	1.65	4000	30.0
MCS19P14-	92.0	160	216	0.54	0.73	9.60	3.66	4000	40.0
MCS19P30-	93.0	160	108	0.14	0.18	2.40	1.83	4000	40.0

¹⁾ Without brake.

²⁾ Mechanically permissible maximum speed.

MCS synchronous servo motors

Technical data



Rated data, non-ventilated

► The data applies to a mains connection voltage of 3 x 230 V.

	n_N [r/min]	M_0 [Nm]	M_N [Nm]	M_{max} [Nm]	P_N [kW]	I_0 [A]	I_N [A]	I_{max} [A]	$U_{N, AC}$ [V]	f_N [Hz]
MCS06C41L	4050	0.80	0.60	2.40	0.25	2.50	2.50	10.8	125	270
MCS06C60L	6000	0.80	0.50	2.40	0.31	4.30	4.00	18.5	85	400
MCS06F41L	4050	1.50	1.20	4.40	0.51	2.90	2.90	10.5	165	270
MCS06F60L	6000	1.50	0.90	4.40	0.57	3.80	3.40	16.5	125	400
MCS06I41L	4050	2.00	1.50	6.20	0.64	3.10	2.90	11.8	175	270
MCS06I60L	6000	2.00	1.20	6.20	0.75	4.20	3.60	16.0	150	400
MCS09D41L	4050	3.30	2.30	9.50	1.00	5.30	4.60	20.0	165	270
MCS09D60L	6000	3.30	1.80	9.50	1.10	10.3	7.00	39.0	110	400
MCS09F38L	3750	4.20	3.10	15.0	1.20	6.00	5.00	30.0	160	250
MCS09F60L	6000	4.20	2.40	15.0	1.50	10.5	7.90	53.0	125	400
MCS09H41L	4050	5.50	3.80	20.0	1.60	8.50	6.80	40.0	160	270
MCS09H60L	6000	5.50	3.00	20.0	1.90	12.0	8.00	57.0	145	400
MCS09L41L	4050	7.50	4.50	32.0	1.90	12.4	8.40	64.0	145	270

	$\eta_{100\%}$ [%]	$J^{1)}$ [kgcm ²]	$KE_{LL 150\text{ }^\circ\text{C}}$ [V/(1000 r/min)]	$R_{UV 20\text{ }^\circ\text{C}}$ [Ω]	$R_{UV 150\text{ }^\circ\text{C}}$ [Ω]	L_N [mH]	$Kt_{0 150\text{ }^\circ\text{C}}$ [Nm/A]	$n_{max}^{2)}$ [r/min]	$m^{1)}$ [kg]
MCS06C41L	65.0	0.14	21.5	6.00	8.00	12.8	0.33	8000	1.80
MCS06C60L	70.0	0.14	12.5	2.20	2.90	4.30	0.19	8000	1.80
MCS06F41L	81.0	0.22	34.5	5.50	7.40	15.9	0.62	8000	2.20
MCS06F60L	82.0	0.22	22.2	2.30	3.00	6.90	0.40	8000	2.20
MCS06I41L	81.0	0.30	38.0	4.70	6.20	15.1	0.64	8000	2.90
MCS06I60L	84.0	0.30	28.5	2.50	3.40	9.30	0.48	8000	2.90
MCS09D41L	87.0	1.10	35.6	1.80	2.40	6.30	0.62	7000	4.30
MCS09D60L	87.0	1.10	18.3	0.45	0.61	1.70	0.32	7000	4.30
MCS09F38L	90.0	1.50	39.9	1.30	1.80	6.20	0.70	7000	5.20
MCS09F60L	91.0	1.50	22.8	0.42	0.56	2.00	0.40	7000	5.20
MCS09H41L	91.0	1.90	37.8	0.80	1.10	4.00	0.65	7000	6.10
MCS09H60L	91.0	1.90	26.6	0.36	0.48	2.00	0.46	7000	6.10
MCS09L41L	91.0	2.80	35.9	0.44	0.59	2.50	0.60	7000	7.90

¹⁾ Without brake.

²⁾ Mechanically permissible maximum speed.

MCS synchronous servo motors

Technical data



Rated data, non-ventilated

► The data applies to a mains connection voltage of 3 x 230 V.

	n_N [r/min]	M_0 [Nm]	M_N [Nm]	M_{max} [Nm]	P_N [kW]	I_0 [A]	I_N [A]	I_{max} [A]	$U_{N, AC}$ [V]	f_N [Hz]
MCS12D20L	1950	6.40	5.50	18.0	1.10	5.50	5.20	20.0	175	130
MCS12D41L	4050	6.40	4.30	18.0	1.80	10.7	8.80	40.0	155	270
MCS12H15L	1500	11.4	10.0	29.0	1.60	8.20	7.80	24.0	158	100
MCS12H30L	3000	11.4	8.00	29.0	2.50	13.5	10.5	39.0	165	200
MCS12L20L	1950	15.0	13.5	56.0	2.80	12.4	11.8	57.0	165	130

	$\eta_{100\%}$ [%]	$J^{1)}$ [kgcm ²]	$KE_{LL, 150\text{ °C}}$ [V / (1000 r/min)]	$R_{UV, 20\text{ °C}}$ [Ω]	$R_{UV, 150\text{ °C}}$ [Ω]	L_N [mH]	$Kt_{0, 150\text{ °C}}$ [Nm/A]	$n_{max}^{2)}$ [r/min]	$m^{1)}$ [kg]
MCS12D20L	79.0	4.00	68.6	2.20	2.90	13.0	1.17	6000	6.40
MCS12D41L	84.0	4.00	35.0	0.55	0.75	3.40	0.60	6000	6.40
MCS12H15L	82.0	7.30	86.5	1.41	1.90	10.5	1.40	6000	9.50
MCS12H30L	87.0	7.30	53.0	0.50	0.67	4.00	0.86	6000	9.50
MCS12L20L	90.0	10.6	76.9	0.55	0.75	5.50	1.21	6000	12.6

¹⁾ Without brake.

²⁾ Mechanically permissible maximum speed.

MCS synchronous servo motors

Technical data



Rated data, forced ventilated

► The data applies to a mains connection voltage of 3 x 400 V.

	n_N [r/min]	M_0 [Nm]	M_N [Nm]	M_{max} [Nm]	P_N [kW]	I_0 [A]	I_N [A]	I_{max} [A]	$U_{N, AC}$ [V]	f_N [Hz]
MCS12D17-	1650	7.50	7.00	17.7	1.20	3.20	3.00	10.0	330	110
MCS12D35-	3525	7.50	6.00	17.7	2.20	6.40	5.60	20.0	300	235
MCS12H14-	1350	12.8	12.0	29.0	1.70	4.30	4.10	12.0	310	90
MCS12H34-	3375	12.8	10.5	29.0	3.70	8.50	7.50	24.0	320	225
MCS12L17-	1650	19.0	17.0	56.4	2.90	7.20	6.70	28.0	300	110
MCS12L39-	3900	19.0	14.0	56.4	5.70	14.4	11.7	57.0	295	260
MCS14D14-	1350	12.5	12.0	29.0	1.70	5.70	5.40	17.0	345	90
MCS14D30-	3000	12.5	10.5	29.0	3.30	11.4	9.70	33.0	325	200
MCS14H12-	1200	25.5	23.5	54.8	3.00	9.30	8.30	26.0	335	80
MCS14H28-	2775	25.5	20.5	54.8	6.00	18.4	15.0	52.0	325	185
MCS14L14-	1350	34.5	30.5	77.1	4.30	13.4	11.8	37.0	335	90
MCS14L30-	3000	34.5	25.5	77.1	8.00	26.7	20.8	75.0	310	200
MCS14P11-	1050	43.5	42.0	105	4.60	14.1	13.4	46.0	330	70
MCS14P26-	2625	43.5	33.0	105	9.10	28.3	21.9	92.0	325	175

	$\eta_{100\%}$ [%]	$J^{1)}$ [kgcm ²]	$KE_{LL 150\text{ °C}}$ [V/(1000 r/min)]	$R_{UV 20\text{ °C}}$ [Ω]	$R_{UV 150\text{ °C}}$ [Ω]	L_N [mH]	$Kt_{0 150\text{ °C}}$ [Nm/A]	$n_{max}^{2)}$ [r/min]	$m^{1)}$ [kg]
MCS12D17-	75.0	4.00	137	8.72	11.8	52.2	2.34	6000	8.50
MCS12D35-	82.0	4.00	68.6	2.18	2.94	13.0	1.17	6000	8.50
MCS12H14-	80.0	7.30	173	5.72	7.72	42.1	2.98	6000	11.6
MCS12H34-	86.0	7.30	86.5	1.39	1.88	10.5	1.51	6000	11.6
MCS12L17-	90.0	10.6	149	2.22	2.99	21.8	2.64	6000	14.7
MCS12L39-	94.0	10.6	74.6	0.55	0.75	5.50	1.32	6000	14.7
MCS14D14-	84.0	8.10	129	4.00	5.40	49.8	2.19	6000	14.5
MCS14D30-	92.0	8.10	64.2	1.00	1.35	12.5	1.09	6000	14.5
MCS14H12-	87.0	14.2	153	2.08	2.81	34.1	2.75	6000	19.5
MCS14H28-	93.0	14.2	76.3	0.52	0.70	8.50	1.39	6000	19.5
MCS14L14-	88.0	23.4	152	1.21	1.64	22.0	2.57	6000	24.0
MCS14L30-	92.0	23.4	76.2	0.30	0.41	5.50	1.29	6000	24.0
MCS14P11-	86.0	34.7	179	1.10	1.49	23.9	3.08	6000	29.0
MCS14P26-	92.0	34.7	89.4	0.28	0.37	6.00	1.54	6000	29.0

¹⁾ Without brake.

²⁾ Mechanically permissible maximum speed.

MCS synchronous servo motors

Technical data



Rated data, forced ventilated

► The data applies to a mains connection voltage of 3 x 400 V.

	n_N [r/min]	M_0 [Nm]	M_N [Nm]	M_{max} [Nm]	P_N [kW]	I_0 [A]	I_N [A]	I_{max} [A]	$U_{N, AC}$ [V]	f_N [Hz]
MCS19F12-	1200	41.5	38.0	86.0	4.80	12.2	11.3	31.0	320	80
MCS19F29-	2850	41.5	32.5	86.0	9.70	24.5	20.1	63.0	320	190
MCS19J12-	1200	70.5	62.5	129	7.90	20.3	18.3	45.0	320	80
MCS19J29-	2850	70.5	50.5	129	15.1	40.6	31.0	90.0	315	190
MCS19P12-	1200	86.0	72.0	190	9.00	22.4	21.3	60.0	310	80
MCS19P29-	2850	86.0	53.0	190	15.8	44.7	29.5	120	315	190

	$\eta_{100\%}$ [%]	$J^1)$ [kgcm ²]	$KE_{LL 150\text{ °C}}$ [V / (1000 r/min)]	$R_{UV 20\text{ °C}}$ [Ω]	$R_{UV 150\text{ °C}}$ [Ω]	L_N [mH]	$Kt_{0 150\text{ °C}}$ [Nm/A]	$n_{max}^2)$ [r/min]	$m^1)$ [kg]
MCS19F12-	90.4	65.0	195	1.30	1.75	20.8	3.40	4000	29.0
MCS19F29-	94.7	65.0	97.2	0.32	0.44	5.20	1.69	4000	29.0
MCS19J12-	89.3	105	199	0.65	0.88	12.8	3.47	4000	36.0
MCS19J29-	92.8	105	99.5	0.16	0.22	3.20	1.74	4000	36.0
MCS19P12-	90.3	160	216	0.54	0.73	9.60	3.84	4000	46.0
MCS19P29-	93.4	160	108	0.14	0.18	2.40	1.92	4000	46.0

¹⁾ Without brake.

²⁾ Mechanically permissible maximum speed.

MCS synchronous servo motors

Technical data



Selection tables, Servo Drives 9400 HighLine

Non-ventilated motors

- The data applies to a mains connection voltage of 3 x 400 V and an inverter switching frequency of 4 kHz.

					E94A□□	E0024	E0034	E0044	E0074	E0094	E0134	E0174	E0244	E0324	E0474	E0594
					I_N	1.9	3.1	5.0	8.8	11.7	16.3	20.6	29.4	38.4	47.0	59.0
					$I_{0,max}$	6.0	10.0	16.0	21.0	28.0	39.0	49.5	58.8	76.8	94.0	118.0
MCS	M_N	n_N	I_N	P_N	I_{max}	6.0	10.0	16.0	21.0	28.0	39.0	49.5	58.8	76.8	94.0	118.0
06C41-	0.6	4050	1.3	0.25	M_0	0.8										
					M_N	0.6										
					$M_{0,max}$	2.4										
					M_{max}	2.4										
					η_{eto}	-										
06C60-	0.5	6000	2.4	0.31	M_0	0.6	0.8									
					M_N	0.4	0.5									
					$M_{0,max}$	1.5	2.3									
					M_{max}	1.5	2.3									
					η_{eto}	-	-									
06F41-	1.2	4050	1.5	0.51	M_0	1.5										
					M_N	1.2										
					$M_{0,max}$	4.4										
					M_{max}	4.4										
					η_{eto}	-										
06F60-	0.9	6000	2.5	0.57	M_0	1.0	1.5									
					M_N	0.7	0.9									
					$M_{0,max}$	3.0	4.3									
					M_{max}	3.0	4.3									
					η_{eto}	-	-									
06I41-	1.5	4050	1.6	0.64	M_0	2.0										
					M_N	1.5										
					$M_{0,max}$	6.2										
					M_{max}	6.2										
					η_{eto}	-										
06I60-	1.2	6000	2.9	0.75	M_0	1.1	1.8	2.0								
					M_N	0.8	1.2	1.2								
					$M_{0,max}$	3.3	5.5	6.2								
					M_{max}	3.3	5.5	6.2								
					η_{eto}	-	-	-								
09D41-	2.3	4050	2.3	1.00	M_0	2.4	3.3									
					M_N	1.9	2.3									
					$M_{0,max}$	6.3	9.5									
					M_{max}	6.3	9.5									
					η_{eto}	-	-									
09D60-	1.8	6000	3.8	1.10	M_0			3.1	3.3							
					M_N			1.8	1.8							
					$M_{0,max}$			8.0	9.5							
					M_{max}			8.0	9.5							
					η_{eto}			-	-							
09F38-	3.1	3750	2.5	1.20	M_0		4.2	4.2								
					M_N		3.1	3.1								
					$M_{0,max}$		11.6	14.9								
					M_{max}		11.6	14.9								
					η_{eto}		-	-								

- $I...$ [A], $M...$ [Nm], $n...$ [r/min], $P...$ [kW]

MCS synchronous servo motors

Technical data



Selection tables, Servo Drives 9400 HighLine

Non-ventilated motors

- The data applies to a mains connection voltage of 3 x 400 V and an inverter switching frequency of 4 kHz.

					E94A□□	E0024	E0034	E0044	E0074	E0094	E0134	E0174	E0244	E0324	E0474	E0594
					I_N	1.9	3.1	5.0	8.8	11.7	16.3	20.6	29.4	38.4	47.0	59.0
					$I_{0,max}$	6.0	10.0	16.0	21.0	28.0	39.0	49.5	58.8	76.8	94.0	118.0
MCS	M_N	n_N	I_N	P_N	I_{max}	6.0	10.0	16.0	21.0	28.0	39.0	49.5	58.8	76.8	94.0	118.0
09F60-	2.4	6000	4.5	1.50	M_0			3.5	4.2	4.2	4.2					
					M_N			2.4	2.4	2.4	2.4					
					$M_{0,max}$			9.8	12.0	14.4	14.9					
					M_{max}			9.8	12.0	14.4	14.9					
					η_{eto}			-	-	-	-					
09H41-	3.8	4050	3.4	1.60	M_0		4.0	5.5	5.5							
					M_N		3.5	3.8	3.8							
					$M_{0,max}$		12.0	17.5	20.4							
					M_{max}		12.0	17.5	20.4							
					η_{eto}		-	-	-							
09H60-	3.0	6000	6.0	1.90	M_0				5.5	5.5	5.5	5.5				
					M_N				3.0	3.0	3.0	3.0				
					$M_{0,max}$				12.5	15.8	20.1	20.4				
					M_{max}				12.5	15.8	20.1	20.4				
					η_{eto}				-	-	-	-				
09L41-	4.5	4050	4.2	1.90	M_0			6.0	7.5	7.5						
					M_N			4.5	4.5	4.5						
					$M_{0,max}$			17.4	22.2	28.5						
					M_{max}			17.4	22.2	28.5						
					η_{eto}			-	-	-						
09L51-	3.6	5100	6.9	1.90	M_0				5.3	7.0	7.5	7.5	7.5			
					M_N				3.6	3.6	3.6	3.6	3.6			
					$M_{0,max}$				11.9	15.5	20.9	25.8	29.7			
					M_{max}				11.9	15.5	20.9	25.8	29.7			
					η_{eto}				-	-	-	-	-			
12D20-	5.5	1950	2.6	1.10	M_0	4.4	6.4									
					M_N	4.0	5.5									
					$M_{0,max}$	11.8	17.7									
					M_{max}	11.8	17.7									
					η_{eto}	-	-									
12D41-	4.3	4050	4.5	1.80	M_0			5.9	6.4							
					M_N			4.3	4.3							
					$M_{0,max}$			14.7	17.7							
					M_{max}			14.7	17.7							
					η_{eto}			-	-							
12H15-	10.0	1500	3.8	1.60	M_0		8.7	11.4								
					M_N		8.2	10.0								
					$M_{0,max}$		24.6	29.0								
					M_{max}		24.6	29.0								
					η_{eto}		-	-								
12H35-	7.5	3525	5.7	2.80	M_0			7.0	11.4	11.4	11.4					
					M_N			6.6	7.5	7.5	7.5					
					$M_{0,max}$			20.1	25.8	29.0	29.0					
					M_{max}			20.1	25.8	29.0	29.0					
					η_{eto}			-	-	-	-					

- $I...$ [A], $M...$ [Nm], $n...$ [r/min], $P...$ [kW]

MCS synchronous servo motors

Technical data



Selection tables, Servo Drives 9400 HighLine

Non-ventilated motors

- The data applies to a mains connection voltage of 3 x 400 V and an inverter switching frequency of 4 kHz.

					E94A□□	E0024	E0034	E0044	E0074	E0094	E0134	E0174	E0244	E0324	E0474	E0594				
					I_N	1.9	3.1	5.0	8.8	11.7	16.3	20.6	29.4	38.4	47.0	59.0				
					$I_{0,max}$	6.0	10.0	16.0	21.0	28.0	39.0	49.5	58.8	76.8	94.0	118.0				
MCS	M_N	n_N	I_N	P_N	I_{max}	6.0	10.0	16.0	21.0	28.0	39.0	49.5	58.8	76.8	94.0	118.0				
12L20-	13.5	1950	5.9	2.80	M_0			12.1	15.0	15.0	15.0									
					M_N			11.4	13.5	13.5	13.5									
					$M_{0,max}$			35.5	44.6	55.7	56.4									
					M_{max}			35.5	44.6	55.7	56.4									
					η_{eto}			-	-	-	-									
12L41-	11.0	4050	10.2	4.70	M_0				10.6	14.0	15.0	15.0	15.0							
					M_N				9.5	11.0	11.0	11.0	11.0							
					$M_{0,max}$				24.4	31.6	41.9	50.8	56.4							
					M_{max}				24.4	31.6	41.9	50.8	56.4							
					η_{eto}				-	-	-	-	-							
14D15-	9.2	1500	4.5	1.45	M_0			11.0	11.0											
					M_N			9.2	9.2											
					$M_{0,max}$			28.3	29.0											
					M_{max}			28.3	29.0											
					η_{eto}			-	-											
14D36-	7.5	3600	7.5	2.80	M_0				9.6	11.0	11.0									
					M_N				7.5	7.5	7.5									
					$M_{0,max}$				20.2	25.6	29.0									
					M_{max}				20.2	25.6	29.0									
					η_{eto}				-	-	-									
14H15-	16.0	1500	6.6	2.50	M_0			12.4	21.0	21.0	21.0									
					M_N			12.1	16.0	16.0	16.0									
					$M_{0,max}$			37.1	46.6	54.8	54.8									
					M_{max}			37.1	46.6	54.8	54.8									
					η_{eto}			-	-	-	-									
14H32-	14.0	3225	11.9	4.70	M_0					14.4	20.3	21.0	21.0							
					M_N					13.6	14.0	14.0	14.0							
					$M_{0,max}$					33.0	43.9	53.2	54.8							
					M_{max}					33.0	43.9	53.2	54.8							
					η_{eto}					-	-	-	-							
14L15-	23.0	1500	9.7	3.60	M_0				20.5	27.1	28.0									
					M_N				20.9	23.0	23.0									
					$M_{0,max}$				48.0	61.4	77.1									
					M_{max}				48.0	61.4	77.1									
					η_{eto}				-	-	-									
14L32-	17.2	3225	15.0	5.80	M_0						19.0	24.0	28.0	28.0	28.0					
					M_N						17.2	17.2	17.2	17.2	17.2					
					$M_{0,max}$						45.0	55.3	63.9	77.1	77.1					
					M_{max}						45.0	55.3	63.9	77.1	77.1					
					η_{eto}						-	-	-	-	-					
14P14-	30.0	1350	10.8	4.20	M_0				26.7	35.2	37.0	37.0								
					M_N				24.4	30.0	30.0	30.0								
					$M_{0,max}$				56.1	71.7	93.3	105.1								
					M_{max}				56.1	71.7	93.3	105.1								
					η_{eto}				-	-	-	-								

- $I...$ [A], $M...$ [Nm], $n...$ [r/min], $P...$ [kW]

MCS synchronous servo motors

Technical data



Selection tables, Servo Drives 9400 HighLine

Non-ventilated motors

- The data applies to a mains connection voltage of 3 x 400 V and an inverter switching frequency of 4 kHz.

					E94A□□	E0024	E0034	E0044	E0074	E0094	E0134	E0174	E0244	E0324	E0474	E0594
					I _N	1.9	3.1	5.0	8.8	11.7	16.3	20.6	29.4	38.4	47.0	59.0
					I _{0,max}	6.0	10.0	16.0	21.0	28.0	39.0	49.5	58.8	76.8	94.0	118.0
MCS	M _N	n _N	I _N	P _N	I _{max}	6.0	10.0	16.0	21.0	28.0	39.0	49.5	58.8	76.8	94.0	118.0
14P32-	21.0	3225	15.6	7.10	M ₀						24.8	31.4	37.0	37.0	37.0	
					M _N						21.0	21.0	21.0	21.0	21.0	
					M _{0,max}						52.5	64.6	74.7	92.2	105.1	
					M _{max}						52.5	64.6	74.7	92.2	105.1	
					η _{eto}						-	-	-	-	-	
19F14-	27.0	1425	8.6	4.00	M ₀			28.4	32.0	32.0						
					M _N			27.0	27.0	27.0						
					M _{0,max}			62.1	78.9	86.0						
					M _{max}			62.1	78.9	86.0						
					η _{eto}			-	-	-						
19F30-	21.0	3000	14.0	6.60	M ₀					26.3	32.0	32.0	32.0			
					M _N					21.0	21.0	21.0	21.0			
					M _{0,max}					56.6	70.2	81.6	86.0			
					M _{max}					56.6	70.2	81.6	86.0			
					η _{eto}					-	-	-	-			
19J14-	40.0	1425	12.3	6.00	M ₀				38.9	51.0	51.0					
					M _N				37.7	40.0	40.0					
					M _{0,max}				85.0	114.4	129.0					
					M _{max}				85.0	114.4	129.0					
					η _{eto}				-	-	-					
19J30-	29.0	3000	18.5	9.10	M ₀					27.3	34.4	49.2	51.0	51.0		
					M _N					25.6	29.0	29.0	29.0	29.0		
					M _{0,max}					60.8	75.9	88.9	112.9	129.0		
					M _{max}					60.8	75.9	88.9	112.9	129.0		
					η _{eto}					-	-	-	-	-		
19P14-	51.0	1350	14.3	7.20	M ₀					59.6	64.0	64.0	64.0			
					M _N					51.0	51.0	51.0	51.0			
					M _{0,max}					128.4	159.9	186.6	190.0			
					M _{max}					128.4	159.9	186.6	190.0			
					η _{eto}					-	-	-	-			
19P30-	32.0	3000	19.0	10.00	M ₀					29.9	37.8	53.9	64.0	64.0	64.0	
					M _N					27.5	32.0	32.0	32.0	32.0	32.0	
					M _{0,max}					65.7	83.6	98.5	126.6	152.5	187.2	
					M _{max}					65.7	83.6	98.5	126.6	152.5	187.2	
					η _{eto}					-	-	-	-	-	-	

- I... [A], M... [Nm], n... [r/min], P... [kW]

MCS synchronous servo motors

Technical data



Selection tables, Servo Drives 9400 HighLine

Non-ventilated motors

- The data applies to a mains connection voltage of 3x230V and an inverter switching frequency of 4 kHz.

					E94A□□	E0024	E0034	E0044	E0074	E0094	E0134	E0174	E0244	E0324
					I_N	1.9	3.1	5.0	8.8	11.7	16.3	20.6	29.4	38.4
					$I_{0,max}$	6.0	10.0	16.0	21.0	28.0	39.0	49.5	58.8	76.8
MCS	M_N	n_N	I_N	P_N	I_{max}	6.0	10.0	16.0	21.0	28.0	39.0	49.5	58.8	76.8
06C41L	0.6	4050	2.6	0.25	M_0	0.6	0.8							
					M_N	0.5	0.6							
					$M_{0,max}$	1.5	2.3							
					M_{max}	1.5	2.3							
					η_{eto}	-	-							
06C60L	0.5	6000	4.0	0.31	M_0		0.6	0.8	0.8					
					M_N		0.4	0.5	0.5					
					$M_{0,max}$		1.5	2.2	2.4					
					M_{max}		1.5	2.2	2.4					
					η_{eto}		-	-	-					
06F41L	1.2	4050	2.9	0.51	M_0	1.0	1.5	1.5						
					M_N	0.8	1.2	1.2						
					$M_{0,max}$	2.7	4.2	4.4						
					M_{max}	2.7	4.2	4.4						
					η_{eto}	-	-	-						
06F60L	0.9	6000	3.8	0.57	M_0		1.2	1.5	1.5					
					M_N		0.8	0.9	0.9					
					$M_{0,max}$		3.1	4.3	4.4					
					M_{max}		3.1	4.3	4.4					
					η_{eto}		-	-	-					
06I41L	1.5	4050	3.2	0.64	M_0		2.0	2.0						
					M_N		1.5	1.5						
					$M_{0,max}$		5.4	6.2						
					M_{max}		5.4	6.2						
					η_{eto}		-	-						
06I60L	1.2	6000	3.8	0.75	M_0		1.5	2.0						
					M_N		1.0	1.2						
					$M_{0,max}$		4.4	6.2						
					M_{max}		4.4	6.2						
					η_{eto}		-	-						
09D41L	2.3	4050	4.6	1.00	M_0			3.1	3.3					
					M_N			2.3	2.3					
					$M_{0,max}$			8.0	9.5					
					M_{max}			8.0	9.5					
					η_{eto}			-	-					
09D60L	1.8	6000	7.0	1.10	M_0				2.8	3.3	3.3			
					M_N				1.8	1.8	1.8			
					$M_{0,max}$				5.7	7.3	9.5			
					M_{max}				5.7	7.3	9.5			
					η_{eto}				-	-	-			
09F38L	3.1	3750	5.0	1.20	M_0			3.5	4.2	4.2	4.2			
					M_N			3.1	3.1	3.1	3.1			
					$M_{0,max}$			9.8	12.0	13.8	15.0			
					M_{max}			9.8	12.0	13.8	15.0			
					η_{eto}			-	-	-	-			

- $I...$ [A], $M...$ [Nm], $n...$ [r/min], $P...$ [kW]

MCS synchronous servo motors

Technical data



Selection tables, Servo Drives 9400 HighLine

Non-ventilated motors

- The data applies to a mains connection voltage of 3x230V and an inverter switching frequency of 4 kHz.

					E94A□□	E0024	E0034	E0044	E0074	E0094	E0134	E0174	E0244	E0324
					I_N	1.9	3.1	5.0	8.8	11.7	16.3	20.6	29.4	38.4
					$I_{0,max}$	6.0	10.0	16.0	21.0	28.0	39.0	49.5	58.8	76.8
MCS	M_N	n_N	I_N	P_N	I_{max}	6.0	10.0	16.0	21.0	28.0	39.0	49.5	58.8	76.8
09F60L	2.4	6000	7.9	1.50	M_0				3.5	4.2	4.2	4.2	4.2	
					M_N				2.4	2.4	2.4	2.4	2.4	
					$M_{0,max}$				7.8	9.8	12.6	14.5	15.0	
					M_{max}				7.8	9.8	12.6	14.5	15.0	
					η_{eto}				-	-	-	-	-	
09H41L	3.8	4050	6.8	1.60	M_0				5.5	5.3	5.5	5.5		
					M_N				3.8	3.0	3.8	3.8		
					$M_{0,max}$				12.4	11.8	19.7	20.0		
					M_{max}				12.4	11.8	19.7	20.0		
					η_{eto}				-	-	-	-		
09H60L	3.0	6000	8.0	1.90	M_0				4.0	5.5	5.5	5.5	5.5	
					M_N				3.0	3.8	3.0	3.0	3.0	
					$M_{0,max}$				9.2	15.6	15.4	18.3	20.0	
					M_{max}				9.2	15.6	15.4	18.3	20.0	
					η_{eto}				-	-	-	-	-	
09L41L	4.5	4050	8.4	1.90	M_0				5.3	7.0	7.5	7.5	7.5	7.5
					M_N				4.5	4.5	4.5	4.5	4.5	4.5
					$M_{0,max}$				11.9	15.5	20.9	25.8	29.7	31.9
					M_{max}				11.9	15.5	20.9	25.8	29.7	31.9
					η_{eto}				-	-	-	-	-	-
12D20L	5.5	1950	5.2	1.10	M_0			5.9	6.4					
					M_N			5.3	5.5					
					$M_{0,max}$			14.9	17.7					
					M_{max}			14.9	17.7					
					η_{eto}			-	-					
12D41L	4.3	4050	8.8	1.80	M_0				5.3	6.4	6.4	6.4		
					M_N				4.3	4.3	4.3	4.3		
					$M_{0,max}$				10.6	13.6	17.7	17.9		
					M_{max}				10.6	13.6	17.7	17.9		
					η_{eto}				-	-	-	-		
12H15L	10.0	1500	7.6	1.60	M_0				11.4	11.4	10.0			
					M_N				10.0	10.0	11.4			
					$M_{0,max}$				25.8	29.0	29.0			
					M_{max}				25.8	29.0	29.0			
					η_{eto}				-	-	-			
12H30L	8.0	3000	10.5	2.50	M_0				7.4	9.8	11.4			
					M_N				6.7	8.0	8.0			
					$M_{0,max}$				16.4	21.5	29.0			
					M_{max}				16.4	21.5	29.0			
					η_{eto}				-	-	-			
12L20L	13.5	1950	11.8	2.80	M_0				10.6	14.0	15.0	15.0	15.0	
					M_N				10.1	13.3	13.5	13.5	13.5	
					$M_{0,max}$				24.4	31.5	41.8	50.5	56.0	
					M_{max}				24.4	31.5	41.8	50.5	56.0	
					η_{eto}				-	-	-	-	-	

- $I...$ [A], $M...$ [Nm], $n...$ [r/min], $P...$ [kW]

MCS synchronous servo motors

Technical data



Selection tables, Servo Drives 9400 HighLine

Forced ventilated IP54 motors

- The data applies to a mains connection voltage of 3 x 400 V and an inverter switching frequency of 4 kHz.

					E94A□□	E0024	E0034	E0044	E0074	E0094	E0134	E0174	E0244	E0324	E0474	E0594
					I_N	1.9	3.1	5.0	8.8	11.7	16.3	20.6	29.4	38.4	47.0	59.0
					$I_{0,max}$	6.0	10.0	16.0	21.0	28.0	39.0	49.5	58.8	76.8	94.0	118.0
MCS	M_N	n_N	I_N	P_N	I_{max}	6.0	10.0	16.0	21.0	28.0	39.0	49.5	58.8	76.8	94.0	118.0
12D17-	7.0	1650	3.0	1.20	M_0	4.4	7.3									
					M_N	4.0	7.0									
					$M_{0,max}$	11.8	17.7									
					M_{max}	11.8	17.7									
					η_{eto}	-	-									
12D35-	6.0	3525	5.6	2.20	M_0			5.9	7.5							
					M_N			5.4	6.0							
					$M_{0,max}$			14.7	17.7							
					M_{max}			14.7	17.7							
					η_{eto}			-	-							
12H14-	12.0	1350	4.1	1.70	M_0		8.7	12.8								
					M_N		8.2	12.0								
					$M_{0,max}$		24.6	29.0								
					M_{max}		24.6	29.0								
					η_{eto}		-	-								
12H34-	10.5	3375	7.5	3.70	M_0			7.0	12.8	12.8	12.8					
					M_N			6.6	10.5	10.5	10.5					
					$M_{0,max}$			20.1	25.8	29.0	29.0					
					M_{max}			20.1	25.8	29.0	29.0					
					η_{eto}			-	-	-	-					
12L17-	17.0	1650	6.7	2.90	M_0			12.1	19.0	19.0	19.0					
					M_N			11.4	17.0	17.0	17.0					
					$M_{0,max}$			35.5	44.6	55.7	56.4					
					M_{max}			35.5	44.6	55.7	56.4					
					η_{eto}			-	-	-	-					
12L39-	14.0	3900	11.7	5.70	M_0				10.6	15.3	19.0	19.0	19.0			
					M_N				9.5	13.9	14.0	14.0	14.0			
					$M_{0,max}$				24.4	31.6	41.9	50.8	56.4			
					M_{max}				24.4	31.6	41.9	50.8	56.4			
					η_{eto}				-	-	-	-	-			
14D14-	12.0	1350	5.4	1.70	M_0			11.0	12.5							
					M_N			11.0	12.0							
					$M_{0,max}$			28.3	29.0							
					M_{max}			28.3	29.0							
					η_{eto}			-	-							
14D30-	10.5	3000	9.7	3.30	M_0				9.6	12.5	12.5					
					M_N				9.5	10.5	10.5					
					$M_{0,max}$				20.2	25.6	29.0					
					M_{max}				20.2	25.6	29.0					
					η_{eto}				-	-	-					
14H12-	23.5	1200	8.3	3.00	M_0			12.4	24.1	25.5	25.5					
					M_N			12.1	23.5	23.5	23.5					
					$M_{0,max}$			37.1	46.6	54.8	54.8					
					M_{max}			37.1	46.6	54.8	54.8					
					η_{eto}			-	-	-	-					

- $I...$ [A], $M...$ [Nm], $n...$ [r/min], $P...$ [kW]

MCS synchronous servo motors

Technical data



Selection tables, Servo Drives 9400 HighLine

Forced ventilated IP54 motors

- The data applies to a mains connection voltage of 3 x 400 V and an inverter switching frequency of 4 kHz.

					E94A□□	E0024	E0034	E0044	E0074	E0094	E0134	E0174	E0244	E0324	E0474	E0594				
					I_N	1.9	3.1	5.0	8.8	11.7	16.3	20.6	29.4	38.4	47.0	59.0				
					$I_{0,max}$	6.0	10.0	16.0	21.0	28.0	39.0	49.5	58.8	76.8	94.0	118.0				
MCS	M_N	n_N	I_N	P_N	I_{max}	6.0	10.0	16.0	21.0	28.0	39.0	49.5	58.8	76.8	94.0	118.0				
14H28-	20.5	2775	15.0	6.00	M_0					16.1	20.5	25.5	25.5							
					M_N					15.9	20.5	20.5	20.5							
					$M_{0,max}$							33.0	43.9	53.2	54.8					
					M_{max}								33.0	43.9	53.2	54.8				
					η_{eto}								-	-	-	-				
14L14-	30.5	1350	11.8	4.30	M_0				20.5	30.0	34.5									
					M_N					20.5	30.0	30.5								
					$M_{0,max}$							48.0	61.4	77.1						
					M_{max}								48.0	61.4	77.1					
					η_{eto}								-	-	-					
14L30-	25.5	3000	20.8	8.00	M_0						21.0	26.6	34.5	34.5	34.5					
					M_N						20.0	25.3	25.5	25.5	25.5					
					$M_{0,max}$							45.0	55.3	63.9	77.1	77.1				
					M_{max}								45.0	55.3	63.9	77.1	77.1			
					η_{eto}								-	-	-	-	-			
14P11-	42.0	1050	13.4	4.60	M_0				26.7	36.4	43.5	43.5								
					M_N					24.4	36.4	42.0	42.0							
					$M_{0,max}$							56.1	71.7	93.3	105.1					
					M_{max}								56.1	71.7	93.3	105.1				
					η_{eto}								-	-	-	-				
14P26-	33.0	2625	21.9	9.10	M_0						24.8	31.4	43.5	43.5	43.5					
					M_N						24.6	31.0	33.0	33.0	33.0					
					$M_{0,max}$							52.5	64.6	74.7	92.2	105.1				
					M_{max}								52.5	64.6	74.7	92.2	105.1			
					η_{eto}								-	-	-	-	-			
19F12-	38.0	1200	11.3	4.80	M_0				29.9	39.5	41.5									
					M_N					29.3	38.0	38.0								
					$M_{0,max}$							62.1	78.9	86.0						
					M_{max}								62.1	78.9	86.0					
					η_{eto}								-	-	-					
19F29-	32.5	2850	20.1	9.70	M_0						26.3	34.9	41.5	41.5						
					M_N						26.0	32.5	32.5	32.5						
					$M_{0,max}$							56.6	70.2	81.6	86.0					
					M_{max}								56.6	70.2	81.6	86.0				
					η_{eto}								-	-	-	-				
19J12-	62.5	1200	18.3	7.90	M_0						56.6	70.5								
					M_N						55.7	62.5								
					$M_{0,max}$							114.4	129.0							
					M_{max}								114.4	129.0						
					η_{eto}								-	-						
19J29-	50.5	2850	31.0	15.10	M_0								49.2	66.7	70.5					
					M_N									47.9	50.5	50.5				
					$M_{0,max}$									88.9	112.9	129.0				
					M_{max}										88.9	112.9	129.0			
					η_{eto}										-	-	-			

- $I...$ [A], $M...$ [Nm], $n...$ [r/min], $P...$ [kW]

MCS synchronous servo motors

Technical data



Selection tables, Servo Drives 9400 HighLine

Forced ventilated IP54 motors

- The data applies to a mains connection voltage of 3 x 400 V and an inverter switching frequency of 4 kHz.

					E94A□□	E0024	E0034	E0044	E0074	E0094	E0134	E0174	E0244	E0324	E0474	E0594
					I_N	1.9	3.1	5.0	8.8	11.7	16.3	20.6	29.4	38.4	47.0	59.0
					$I_{0,max}$	6.0	10.0	16.0	21.0	28.0	39.0	49.5	58.8	76.8	94.0	118.0
MCS	M_N	n_N	I_N	P_N	I_{max}	6.0	10.0	16.0	21.0	28.0	39.0	49.5	58.8	76.8	94.0	118.0
19P12-	72.0	1200	21.3	9.00	M_0							79.1	86.0	86.0		
					M_N							69.6	72.0	72.0		
					$M_{0,max}$							159.9	186.6	190.0		
					M_{max}							159.9	186.6	190.0		
					η_{eto}											-
19P29-	53.0	2850	29.5	15.80	M_0								56.5	73.9	86.0	86.0
					M_N								52.8	53.0	53.0	53.0
					$M_{0,max}$								98.5	126.6	152.5	187.2
					M_{max}								98.5	126.6	152.5	187.2
					η_{eto}											

- $I...$ [A], $M...$ [Nm], $n...$ [r/min], $P...$ [kW]

MCS synchronous servo motors

Technical data



MCS synchronous servo motors

Technical data



Selection tables, Inverter Drives 8400 TopLine

Non-ventilated motors

- The data applies to a mains connection voltage of 3 x 400 V and an inverter switching frequency of 8 kHz.

					E84AVTC	□3714	□5514	□7514	□1124	□1524	□2224	□3024
					I_N	1.3	1.8	2.4	3.2	3.9	5.9	7.3
					$I_{0,max}$	2.0	2.7	3.6	4.8	5.9	8.4	11.0
MCS	M_N	n_N	I_N	P_N	I_{max}	2.6	3.6	4.8	6.4	7.8	11.2	14.6
06C41-	0.6	4050	1.3	0.25	M_0	0.8	0.8	0.8	0.8	0.8		
					M_N	0.6	0.6	0.6	0.6	0.6		
					$M_{0,max}$	1.4	1.7	2.3	2.4	2.4		
					M_{max}	1.4	1.7	2.3	2.4	2.4		
					η_{eto}	-	-	-	-	-		
06C60-	0.5	6000	2.4	0.31	M_0			0.8	0.8	0.8	0.8	0.8
					M_N			0.5	0.5	0.5	0.5	0.5
					$M_{0,max}$			1.3	1.6	2.0	2.4	2.4
					M_{max}			1.3	1.6	2.0	2.4	2.4
					η_{eto}			-	-	-	-	-
06F41-	1.2	4050	1.5	0.51	M_0	1.3	1.5	1.5	1.5	1.5		
					M_N	1.0	1.2	1.2	1.2	1.2		
					$M_{0,max}$	2.3	3.2	4.3	4.4	4.4		
					M_{max}	2.3	3.2	4.3	4.4	4.4		
					η_{eto}	-	-	-	-	-		
06F60-	0.9	6000	2.5	0.57	M_0			1.2	1.5	1.5	1.5	1.5
					M_N			0.9	0.9	0.9	0.9	0.9
					$M_{0,max}$			2.1	3.3	4.0	4.4	4.4
					M_{max}			2.1	3.3	4.0	4.4	4.4
					η_{eto}			-	-	-	-	-
06I41-	1.5	4050	1.6	0.64	M_0	1.6	2.0	2.0	2.0	2.0		
					M_N	1.2	1.5	1.5	1.5	1.5		
					$M_{0,max}$	2.9	4.0	5.3	6.2	6.2		
					M_{max}	2.9	4.0	5.3	6.2	6.2		
					η_{eto}	-	-	-	-	-		
06I60-	1.2	6000	2.9	0.75	M_0				2.0	2.0	2.0	2.0
					M_N				1.2	1.2	1.2	1.2
					$M_{0,max}$				3.6	4.4	5.7	5.7
					M_{max}				3.6	4.4	5.7	5.7
					η_{eto}				-	-	-	-
09D41-	2.3	4050	2.3	1.00	M_0		2.2	3.1	3.3	3.3	3.3	3.3
					M_N		1.7	2.3	2.3	2.3	2.3	2.3
					$M_{0,max}$		4.0	5.3	6.7	8.2	9.4	9.4
					M_{max}		4.0	5.3	6.7	8.2	9.4	9.4
					η_{eto}		-	-	-	-	-	-
09D60-	1.8	6000	3.8	1.10	M_0				2.0	2.4	3.3	3.3
					M_N				1.5	1.8	1.8	1.8
					$M_{0,max}$				3.5	4.2	6.3	7.8
					M_{max}				3.5	4.2	6.3	7.8
					η_{eto}				-	-	-	-
09F38-	3.1	3750	2.5	1.20	M_0			3.4	4.2	4.2	4.2	4.2
					M_N			3.0	3.1	3.1	3.1	3.1
					$M_{0,max}$			6.6	8.4	10.2	12.0	12.0
					M_{max}			6.6	8.4	10.2	12.0	12.0
					η_{eto}			-	-	-	-	-

- $I...$ [A], $M...$ [Nm], $n...$ [r/min], $P...$ [kW]

MCS synchronous servo motors

Technical data



Selection tables, Inverter Drives 8400 TopLine

Non-ventilated motors

- The data applies to a mains connection voltage of 3 x 400 V and an inverter switching frequency of 8 kHz.

□4024	□5524	□7524	□1134	□1534	□1834	□2234	□3034	E84AVTC					
9.5	13.0	16.5	23.5	32.0	39.0	47.0	61.0	I_N	P_N	I_N	n_N	M_N	MCS
14.3	19.5	26.4	32.9	43.2	60.0	70.5	91.5	$I_{0,max}$					
19.0	26.0	33.0	47.0	64.0	78.0	94.0	122.0	I_{max}					
								M_0	0.25	1.3	4050	0.6	06C41-
								M_N					
								$M_{0,max}$					
								M_{max}					
								n_{eto}					
								M_0	0.31	2.4	6000	0.5	06C60-
								M_N					
								$M_{0,max}$					
								M_{max}					
								n_{eto}					
								M_0	0.51	1.5	4050	1.2	06F41-
								M_N					
								$M_{0,max}$					
								M_{max}					
								n_{eto}					
								M_0	0.57	2.5	6000	0.9	06F60-
								M_N					
								$M_{0,max}$					
								M_{max}					
								n_{eto}					
								M_0	0.64	1.6	4050	1.5	06I41-
								M_N					
								$M_{0,max}$					
								M_{max}					
								n_{eto}					
								M_0	0.75	2.9	6000	1.2	06I60-
								M_N					
								$M_{0,max}$					
								M_{max}					
								n_{eto}					
								M_0	1.00	2.3	4050	2.3	09D41-
								M_N					
								$M_{0,max}$					
								M_{max}					
								n_{eto}					
3.3	3.3							M_0	1.10	3.8	6000	1.8	09D60-
1.8	1.8							M_N					
9.1	9.3							$M_{0,max}$					
9.1	9.3							M_{max}					
-	-							n_{eto}					
								M_0	1.20	2.5	3750	3.1	09F38-
								M_N					
								$M_{0,max}$					
								M_{max}					
								n_{eto}					

- $I...$ [A], $M...$ [Nm], $n...$ [r/min], $P...$ [kW]

MCS synchronous servo motors

Technical data



Selection tables, Inverter Drives 8400 TopLine

Non-ventilated motors

- The data applies to a mains connection voltage of 3 x 400 V and an inverter switching frequency of 8 kHz.

					E84AVTC	□3714	□5514	□7514	□1124	□1524	□2224	□3024
					I_N	1.3	1.8	2.4	3.2	3.9	5.9	7.3
					$I_{0,max}$	2.0	2.7	3.6	4.8	5.9	8.4	11.0
MCS	M_N	n_N	I_N	P_N	I_{max}	2.6	3.6	4.8	6.4	7.8	11.2	14.6
09F60-	2.4	6000	4.5	1.50	M_0						4.2	4.2
					M_N						2.4	2.4
					$M_{0,max}$						7.8	9.6
					M_{max}						7.8	9.6
					η_{eto}						-	-
09H41-	3.8	4050	3.4	1.60	M_0				4.7	5.0	5.5	5.5
					M_N				3.6	3.8	3.8	3.8
					$M_{0,max}$				8.1	9.9	14.0	17.4
					M_{max}				8.1	9.9	14.0	17.4
					η_{eto}				-	-	-	-
09H60-	3.0	6000	6.0	1.90	M_0						4.4	4.5
					M_N						3.0	3.0
					$M_{0,max}$						7.5	9.3
					M_{max}						7.5	9.3
					η_{eto}						-	-
09L41-	4.5	4050	4.2	1.90	M_0				3.9	4.7	7.5	7.5
					M_N				3.4	4.2	4.5	4.5
					$M_{0,max}$				7.3	8.9	13.1	16.3
					M_{max}				7.3	8.9	13.1	16.3
					η_{eto}				-	-	-	-
09L51-	3.6	5100	6.9	1.90	M_0							4.2
					M_N							3.6
					$M_{0,max}$							8.3
					M_{max}							8.3
					η_{eto}							-
12D20-	5.5	1950	2.6	1.10	M_0			5.7	6.4	6.4	6.4	6.4
					M_N			5.1	5.5	5.5	5.5	5.5
					$M_{0,max}$			9.6	12.6	15.3	17.7	17.7
					M_{max}			9.6	12.6	15.3	17.7	17.7
					η_{eto}			-	-	-	-	-
12D41-	4.3	4050	4.5	1.80	M_0				3.8	4.6	6.4	6.4
					M_N				3.0	3.7	4.3	4.3
					$M_{0,max}$				6.4	7.8	11.4	14.0
					M_{max}				6.4	7.8	11.4	14.0
					η_{eto}				-	-	-	-
12H15-	10.0	1500	3.8	1.60	M_0				9.2	10.9	11.4	11.4
					M_N				8.4	10.0	10.0	10.0
					$M_{0,max}$				16.4	20.0	29.0	29.0
					M_{max}				16.4	20.0	29.0	29.0
					η_{eto}				-	-	-	-
12H35-	7.5	3525	5.7	2.80	M_0						9.8	9.8
					M_N						7.5	7.5
					$M_{0,max}$						15.2	18.8
					M_{max}						15.2	18.8
					η_{eto}						-	-

- $I...$ [A], $M...$ [Nm], $n...$ [r/min], $P...$ [kW]

MCS synchronous servo motors

Technical data



Selection tables, Inverter Drives 8400 TopLine

Non-ventilated motors

- The data applies to a mains connection voltage of 3 x 400 V and an inverter switching frequency of 8 kHz.

□4024	□5524	□7524	□1134	□1534	□1834	□2234	□3034	E84AVTC						
9.5	13.0	16.5	23.5	32.0	39.0	47.0	61.0	I_N		P_N	I_N	n_N	M_N	MCS
14.3	19.5	26.4	32.9	43.2	60.0	70.5	91.5	$I_{0,max}$						
19.0	26.0	33.0	47.0	64.0	78.0	94.0	122.0	I_{max}						
4.2	4.2							M_0	1.50	4.5	6000	2.4	09F60-	
2.4	2.4							M_N						
11.1	11.4							$M_{0,max}$						
11.1	11.4							M_{max}	1.60	3.4	4050	3.8	09H41-	
-	-							n_{eto}						
5.5	5.5							M_0						
3.8	3.8							M_N	1.90	6.0	6000	3.0	09H60-	
19.6	20.1							$M_{0,max}$						
19.6	20.1							M_{max}						
-	-							n_{eto}	1.90	4.2	4050	4.5	09L41-	
5.5	5.5							M_0						
3.0	3.0							M_N						
11.4	11.7							$M_{0,max}$	1.90	6.9	5100	3.6	09L51-	
11.4	11.7							M_{max}						
-	-							n_{eto}						
7.5	7.5							M_0	1.10	2.6	1950	5.5	12D20-	
4.5	4.5							M_N						
20.3	20.8							$M_{0,max}$						
20.3	20.8							M_{max}	1.80	4.5	4050	4.3	12D41-	
-	-							n_{eto}						
7.5	7.5	7.5	7.5					M_0						
3.6	3.6	3.6	3.6					M_N	1.60	3.8	1500	10.0	12H15-	
10.8	19.1	19.1	19.1					$M_{0,max}$						
10.8	19.1	19.1	19.1					M_{max}						
-	-	-	-					n_{eto}	2.80	5.7	3525	7.5	12H35-	
								M_0						
								M_N						
								$M_{0,max}$	1.80	4.5	4050	4.3	12D41-	
								M_{max}						
								n_{eto}						
6.4	6.4							M_0	1.60	3.8	1500	10.0	12H15-	
4.3	4.3							M_N						
16.9	17.3							$M_{0,max}$						
16.9	17.3							M_{max}	2.80	5.7	3525	7.5	12H35-	
-	-							n_{eto}						
11.4	11.4							M_0						
10.0	10.0							M_N	1.60	3.8	1500	10.0	12H15-	
28.3	29.0							$M_{0,max}$						
28.3	29.0							M_{max}						
-	-							n_{eto}	2.80	5.7	3525	7.5	12H35-	
11.4	11.4							M_0						
7.5	7.5							M_N						
23.5	24.1							$M_{0,max}$	2.80	5.7	3525	7.5	12H35-	
23.5	24.1							M_{max}						
-	-							n_{eto}						

- $I...$ [A], $M...$ [Nm], $n...$ [r/min], $P...$ [kW]

MCS synchronous servo motors

Technical data



Selection tables, Inverter Drives 8400 TopLine

Non-ventilated motors

- The data applies to a mains connection voltage of 3 x 400 V and an inverter switching frequency of 8 kHz.

					E84AVTC	□3714	□5514	□7514	□1124	□1524	□2224	□3024
					I_N	1.3	1.8	2.4	3.2	3.9	5.9	7.3
					$I_{0,max}$	2.0	2.7	3.6	4.8	5.9	8.4	11.0
MCS	M_N	n_N	I_N	P_N	I_{max}	2.6	3.6	4.8	6.4	7.8	11.2	14.6
12L20-	13.5	1950	5.9	2.80	M_0						15.0	15.0
					M_N						13.5	13.5
					$M_{0,max}$						27.4	33.9
					M_{max}						27.4	33.9
					η_{eto}							-
12L41-	11.0	4050	10.2	4.70	M_0							
					M_N							
					$M_{0,max}$							
					M_{max}							
					η_{eto}							
14D15-	9.2	1500	4.5	1.45	M_0				7.0	8.5	11.0	11.0
					M_N				6.6	8.0	9.2	9.2
					$M_{0,max}$				13.1	16.0	22.7	28.1
					M_{max}				13.1	16.0	22.7	28.1
					η_{eto}							-
14D36-	7.5	3600	7.5	2.80	M_0							8.0
					M_N							7.3
					$M_{0,max}$							15.2
					M_{max}							15.2
					η_{eto}							-
14H15-	16.0	1500	6.6	2.50	M_0							17.3
					M_N							16.0
					$M_{0,max}$							35.3
					M_{max}							35.3
					η_{eto}							-
14H32-	14.0	3225	11.9	4.70	M_0							
					M_N							
					$M_{0,max}$							
					M_{max}							
					η_{eto}							
14L15-	23.0	1500	9.7	3.60	M_0							
					M_N							
					$M_{0,max}$							
					M_{max}							
					η_{eto}							
14L32-	17.2	3225	15.0	5.80	M_0							
					M_N							
					$M_{0,max}$							
					M_{max}							
					η_{eto}							
14P14-	30.0	1350	10.8	4.20	M_0							
					M_N							
					$M_{0,max}$							
					M_{max}							
					η_{eto}							

- $I...$ [A], $M...$ [Nm], $n...$ [r/min], $P...$ [kW]

MCS synchronous servo motors

Technical data



Selection tables, Inverter Drives 8400 TopLine

Non-ventilated motors

- The data applies to a mains connection voltage of 3 x 400 V and an inverter switching frequency of 8 kHz.

□4024	□5524	□7524	□1134	□1534	□1834	□2234	□3034	E84AVTC					
9.5	13.0	16.5	23.5	32.0	39.0	47.0	61.0	I_N	2.80	5.9	1950	13.5	12L20-
14.3	19.5	26.4	32.9	43.2	60.0	70.5	91.5	$I_{0,max}$					
19.0	26.0	33.0	47.0	64.0	78.0	94.0	122.0	I_{max}					
15.0	15.0							M_0					
13.5	13.5							M_N					
40.8	41.9							$M_{0,max}$	4.70	10.2	4050	11.0	12L41-
40.8	41.9							M_{max}					
-	-							n_{eto}					
14.0	15.0	15.0	15.0	15.0				M_0					
10.2	11.0	11.0	11.0	11.0				M_N					
22.2	30.4	35.5	35.5	35.5				$M_{0,max}$	1.45	4.5	1500	9.2	14D15-
22.2	30.4	49.6	49.6	49.6				M_{max}					
-	-	-	-	-				n_{eto}					
11.0	11.0							M_0					
9.2	9.2							M_N					
28.3	29.0							$M_{0,max}$	2.80	7.5	3600	7.5	14D36-
28.3	29.0							M_{max}					
-	-							n_{eto}					
11.0	11.0	11.0	11.0					M_0					
7.5	7.5	7.5	7.5					M_N					
21.0	21.0							$M_{0,max}$	2.50	6.6	1500	16.0	14H15-
16.0	16.0							M_N					
42.8	43.9							$M_{0,max}$					
42.8	43.9							M_{max}					
-	-							n_{eto}					
12.9	16.2	21.0	21.0	21.0				M_0	4.70	11.9	3225	14.0	14H32-
11.2	14.0	14.0	14.0	14.0				M_N					
23.2	31.7	37.1	37.1	37.1				$M_{0,max}$					
23.2	31.7	51.9	51.9	51.9				M_{max}					
-	-	-	-	-				n_{eto}					
27.4	28.0	28.0	28.0					M_0	3.60	9.7	1500	23.0	14L15-
22.5	23.0	23.0	23.0					M_N					
43.8	52.9	52.9	52.9					$M_{0,max}$					
43.8	60.0	73.8	73.8					M_{max}					
-	-	-	-					n_{eto}					
	15.2	27.4	27.4	28.0	28.0	28.0		M_0	5.80	15.0	3225	17.2	14L32-
	14.9	17.2	17.2	17.2	17.2	17.2		M_N					
	31.3	39.7	52.9	52.9	52.9	52.9		$M_{0,max}$					
	31.3	57.6	73.9	73.9	73.9	73.9		M_{max}					
	-	-	-	-	-	-		n_{eto}					
32.5	37.0	37.0	37.0	37.0				M_0	4.20	10.8	1350	30.0	14P14-
26.4	30.0	30.0	30.0	30.0				M_N					
51.2	70.0	80.0	80.0	80.0				$M_{0,max}$					
51.2	70.0	105.1	105.1	105.1				M_{max}					
-	-	-	-	-				n_{eto}					

- $I...$ [A], $M...$ [Nm], $n...$ [r/min], $P...$ [kW]

MCS synchronous servo motors

Technical data



Selection tables, Inverter Drives 8400 TopLine

Non-ventilated motors

- The data applies to a mains connection voltage of 3 x 400 V and an inverter switching frequency of 8 kHz.

					E84AVTC	□3714	□5514	□7514	□1124	□1524	□2224	□3024
					I_N	1.3	1.8	2.4	3.2	3.9	5.9	7.3
					$I_{0,max}$	2.0	2.7	3.6	4.8	5.9	8.4	11.0
MCS	M_N	n_N	I_N	P_N	I_{max}	2.6	3.6	4.8	6.4	7.8	11.2	14.6
14P32-	21.0	3225	15.6	7.10	M_0							
					M_N							
					$M_{0,max}$							
					M_{max}							
					η_{eto}							
19F14-	27.0	1425	8.6	4.00	M_0							23.6
					M_N							22.9
					$M_{0,max}$							45.9
					M_{max}							45.9
					η_{eto}							-
19F30-	21.0	3000	14.0	6.60	M_0							
					M_N							
					$M_{0,max}$							
					M_{max}							
					η_{eto}							
19J14-	40.0	1425	12.3	6.00	M_0							
					M_N							
					$M_{0,max}$							
					M_{max}							
					η_{eto}							
19J30-	29.0	3000	18.5	9.10	M_0							
					M_N							
					$M_{0,max}$							
					M_{max}							
					η_{eto}							
19P14-	51.0	1350	14.3	7.20	M_0							
					M_N							
					$M_{0,max}$							
					M_{max}							
					η_{eto}							
19P30-	32.0	3000	19.0	10.00	M_0							
					M_N							
					$M_{0,max}$							
					M_{max}							
					η_{eto}							

- $I...$ [A], $M...$ [Nm], $n...$ [r/min], $P...$ [kW]

MCS synchronous servo motors

Technical data



Selection tables, Inverter Drives 8400 TopLine

Non-ventilated motors

- The data applies to a mains connection voltage of 3 x 400 V and an inverter switching frequency of 8 kHz.

□4024	□5524	□7524	□1134	□1534	□1834	□2234	□3034	E84AVTC						
9.5	13.0	16.5	23.5	32.0	39.0	47.0	61.0	I_N		P_N	I_N	n_N	M_N	MCS
14.3	19.5	26.4	32.9	43.2	60.0	70.5	91.5	$I_{0,max}$						
19.0	26.0	33.0	47.0	64.0	78.0	94.0	122.0	I_{max}						
	19.8	35.8	35.8	37.0	37.0	37.0		M_0	7.10	15.6	3225	21.0	14P32-	
	17.5	21.0	21.0	21.0	21.0	21.0		M_N						
	36.5	46.3	61.8	61.8	61.8	61.8		$M_{0,max}$						
	36.5	67.3	86.4	86.4	86.4	86.4		M_{max}						
	-	-	-	-	-	-		n_{eto}						
32.0	32.0	32.0	32.0					M_0	4.00	8.6	1425	27.0	19F14-	
27.0	27.0	27.0	27.0					M_N						
56.7	68.3	68.3	68.3					$M_{0,max}$						
56.7	77.6	86.0	86.0					M_{max}						
-	-	-	-					n_{eto}						
	21.0	32.0	32.0	32.0				M_0	6.60	14.0	3000	21.0	19F30-	
	19.5	21.0	21.0	21.0				M_N						
	47.2	47.2	47.2	47.2				$M_{0,max}$						
	38.9	68.3	68.3	68.3				M_{max}						
	-	-	-	-				n_{eto}						
	43.6	51.0	51.0	51.0				M_0	6.00	12.3	1425	40.0	19J14-	
	40.0	40.0	40.0	40.0				M_N						
	81.1	96.0	96.0	96.0				$M_{0,max}$						
	81.1	129.0	129.0	129.0				M_{max}						
	-	-	-	-				n_{eto}						
			39.3	51.0	51.0	51.0	51.0	M_0	9.10	18.5	3000	29.0	19J30-	
			29.0	29.0	29.0	29.0	29.0	M_N						
			73.6	79.5	79.5	79.5	79.5	$M_{0,max}$						
			110.4	127.6	127.6	127.6	127.6	M_{max}						
			-	-	-	-	-	n_{eto}						
	47.5	64.0	64.0	64.0				M_0	7.20	14.3	1350	51.0	19P14-	
	46.4	51.0	51.0	51.0				M_N						
	92.7	106.7	106.7	106.7				$M_{0,max}$						
	92.7	155.5	155.5	155.5				M_{max}						
	-	-	-	-				n_{eto}						
			43.1	58.7	64.0	64.0	64.0	M_0	10.00	19.0	3000	32.0	19P30-	
			32.0	32.0	32.0	32.0	32.0	M_N						
			79.2	87.6	87.6	87.6	87.6	$M_{0,max}$						
			118.6	144.3	144.3	144.3	144.3	M_{max}						
			-	-	-	-	-	n_{eto}						

- $I...$ [A], $M...$ [Nm], $n...$ [r/min], $P...$ [kW]

MCS synchronous servo motors

Technical data



Selection tables, Inverter Drives 8400 TopLine

Forced ventilated IP54 motors

- The data applies to a mains connection voltage of 3 x 400 V and an inverter switching frequency of 8 kHz.

					E84AVTC	□1124	□1524	□2224	□3024	□4024	□5524	□7524	□1134	□1534	□1834	□2234	□3034			
					I_N	3.2	3.9	5.9	7.3	9.5	13.0	16.5	23.5	32.0	39.0	47.0	61.0			
					$I_{0,max}$	4.8	5.9	8.4	11.0	14.3	19.5	26.4	32.9	43.2	60.0	70.5	91.5			
MCS	M_N	n_N	I_N	P_N	I_{max}	6.4	7.8	11.2	14.6	19.0	26.0	33.0	47.0	64.0	78.0	94.0	122.0			
12D17-	7.0	1650	3.0	1.20	M_0	7.5	7.5	7.5	7.5											
					M_N	7.0	7.0	7.0	7.0											
					$M_{0,max}$	12.6	15.3	17.7	17.7											
					M_{max}	12.6	15.3	17.7	17.7											
					η_{eto}	-	-	-	-											
12D35-	6.0	3525	5.6	2.20	M_0		4.6	7.5	7.5	7.5	7.5									
					M_N		3.7	6.0	6.0	6.0	6.0									
					$M_{0,max}$		7.8	11.4	14.0	16.9	17.3									
					M_{max}		7.8	11.4	14.0	16.9	17.3									
					η_{eto}		-	-	-	-	-									
12H14-	12.0	1350	4.1	1.70	M_0	8.9	10.9	12.8	12.8	12.8	12.8									
					M_N	8.5	10.3	12.0	12.0	12.0	12.0									
					$M_{0,max}$	16.4	20.0	29.0	29.0	28.3	29.0									
					M_{max}	16.4	20.0	29.0	29.0	28.3	29.0									
					η_{eto}	-	-	-	-	-	-									
12H34-	10.5	3375	7.5	3.70	M_0				10.2	12.8	12.8									
					M_N				10.0	10.5	10.5									
					$M_{0,max}$				18.8	23.5	24.1									
					M_{max}				18.8	23.5	24.1									
					η_{eto}				-	-	-									
12L17-	17.0	1650	6.7	2.90	M_0				18.5	19.0	19.0									
					M_N				17.0	17.0	17.0									
					$M_{0,max}$				33.9	40.8	41.9									
					M_{max}				33.9	40.8	41.9									
					η_{eto}				-	-	-									
12L39-	14.0	3900	11.7	5.70	M_0					17.2	17.2	19.0	19.0	19.0						
					M_N					14.0	14.0	14.0	14.0	14.0						
					$M_{0,max}$					22.2	30.4	35.5	35.5	35.5						
					M_{max}					22.2	30.4	49.6	49.6	49.6						
					η_{eto}					-	-	-	-	-						
14D14-	12.0	1350	5.4	1.70	M_0		8.5	12.5	12.5	12.5	12.5									
					M_N		8.0	12.0	12.0	12.0	12.0									
					$M_{0,max}$		16.0	22.7	28.1	28.3	29.0									
					M_{max}		16.0	22.7	28.1	28.3	29.0									
					η_{eto}		-	-	-	-	-									
14D30-	10.5	3000	9.7	3.30	M_0				7.7	12.2	12.5	12.5	12.5							
					M_N				7.0	9.8	10.0	10.0	10.0							
					$M_{0,max}$				15.2	18.5	25.3	29.0	29.0							
					M_{max}				15.2	18.5	22.2	22.2	22.2							
					η_{eto}				-	-	-	-	-							
14H12-	23.5	1200	8.3	3.00	M_0				18.0	25.5	25.5									
					M_N				17.9	23.5	23.5									
					$M_{0,max}$				35.3	42.8	43.9									
					M_{max}				35.3	42.8	43.9									
					η_{eto}				-	-	-									

- $I...$ [A], $M...$ [Nm], $n...$ [r/min], $P...$ [kW]

MCS synchronous servo motors

Technical data



Selection tables, Inverter Drives 8400 TopLine

Forced ventilated IP54 motors

- The data applies to a mains connection voltage of 3 x 400 V and an inverter switching frequency of 8 kHz.

					E84AVTC	□1124	□1524	□2224	□3024	□4024	□5524	□7524	□1134	□1534	□1834	□2234	□3034
					I_N	3.2	3.9	5.9	7.3	9.5	13.0	16.5	23.5	32.0	39.0	47.0	61.0
					$I_{0,max}$	4.8	5.9	8.4	11.0	14.3	19.5	26.4	32.9	43.2	60.0	70.5	91.5
MCS	M_N	n_N	I_N	P_N	I_{max}	6.4	7.8	11.2	14.6	19.0	26.0	33.0	47.0	64.0	78.0	94.0	122.0
14H28-	20.5	2775	15.0	6.00	M_0						16.2	25.5	25.5	25.5			
					M_N					16.1	20.5	20.5	20.5				
					$M_{0,max}$					31.7	37.1	37.1	37.1				
					M_{max}					31.7	51.9	51.9	51.9				
					η_{eto}									-	-	-	-
14L14-	30.5	1350	11.8	4.30	M_0					26.9	33.4	34.5	34.5				
					M_N					24.6	30.5	30.5	30.5				
					$M_{0,max}$					43.8	52.9	52.9	52.9				
					M_{max}					43.8	60.0	73.8	73.8				
					η_{eto}									-	-	-	-
14L30-	25.5	3000	20.8	8.00	M_0								27.4	34.5	34.5	34.5	
					M_N								25.5	25.5	25.5	25.5	
					$M_{0,max}$								52.9	52.9	52.9	52.9	
					M_{max}								73.9	73.9	73.9	73.9	
					η_{eto}										-	-	-
14P11-	42.0	1050	13.4	4.60	M_0						38.9	43.5	43.5	43.5			
					M_N						38.8	42.0	42.0	42.0			
					$M_{0,max}$						70.0	80.0	80.0	80.0			
					M_{max}						70.0	105.1	105.1	105.1			
					η_{eto}										-	-	-
14P26-	33.0	2625	21.9	9.10	M_0								35.8	43.5	43.5	43.5	
					M_N								33.0	33.0	33.0	33.0	
					$M_{0,max}$								66.0	86.4	86.4	86.4	
					M_{max}								86.4	86.4	86.4	86.4	
					η_{eto}										-	-	-
19F12-	38.0	1200	11.3	4.80	M_0			23.6	34.9	41.5	41.5	41.5					
					M_N			22.9	31.9	38.0	38.0	38.0					
					$M_{0,max}$			45.9	56.7	68.3	68.3	68.3					
					M_{max}			45.9	56.7	77.6	86.0	86.0					
					η_{eto}					-	-	-	-	-			
19F29-	32.5	2850	20.1	9.70	M_0								39.9	41.5			
					M_N								32.5	32.5			
					$M_{0,max}$								47.2	47.2			
					M_{max}								68.3	68.3			
					η_{eto}										-	-	
19J12-	62.5	1200	18.3	7.90	M_0						43.6		70.5	70.5			
					M_N						43.4		62.5	62.5			
					$M_{0,max}$						81.1		96.0	96.0			
					M_{max}						81.1		129.0	129.0			
					η_{eto}										-	-	
19J29-	50.5	2850	31.0	15.10	M_0									55.5	70.5	70.5	70.5
					M_N								50.5	50.5	50.5	50.5	
					$M_{0,max}$								87.6	87.6	87.6	87.6	
					M_{max}								127.6	127.6	127.6	127.6	
					η_{eto}										-	-	-

- $I...$ [A], $M...$ [Nm], $n...$ [r/min], $P...$ [kW]

MCS synchronous servo motors

Technical data



Selection tables, Inverter Drives 8400 TopLine

Forced ventilated IP54 motors

- The data applies to a mains connection voltage of 3 x 400 V and an inverter switching frequency of 8 kHz.

					E84AVTC	□1124	□1524	□2224	□3024	□4024	□5524	□7524	□1134	□1534	□1834	□2234	□3034
					I_N	3.2	3.9	5.9	7.3	9.5	13.0	16.5	23.5	32.0	39.0	47.0	61.0
					$I_{0,max}$	4.8	5.9	8.4	11.0	14.3	19.5	26.4	32.9	43.2	60.0	70.5	91.5
MCS	M_N	n_N	I_N	P_N	I_{max}	6.4	7.8	11.2	14.6	19.0	26.0	33.0	47.0	64.0	78.0	94.0	122.0
19P12-	72.0	1200	21.3	9.00	M_0						47.5		86.0	86.0			
					M_N					46.4	72.0	72.0					
					$M_{0,max}$					92.7	106.7	106.7					
					M_{max}					92.7	155.5	155.5					
					η_{eto}									-	-	-	
19P29-	53.0	2850	29.5	15.80	M_0									58.7	86.0	86.0	86.0
					M_N									53.0	53.0	53.0	53.0
					$M_{0,max}$									87.6	87.6	87.6	87.6
					M_{max}									144.3	144.3	144.3	144.3
					η_{eto}												

- I... [A], M... [Nm], n... [r/min], P... [kW]

MCS synchronous servo motors

Technical data



Selection tables, Servo Drives ECS

Non-ventilated motors

- The data applies to a mains connection voltage of 3 x 400 V and an inverter switching frequency of 4 kHz.

					ECS□□	004C□B	008C□B	016C□B	032C□B	048C□B	064C□B
					I_N	2.0	4.0	8.0	12.7	17.0	20.0
					$I_{0,max}$	2.3	4.6	9.1	18.1	27.2	36.3
MCS	M_N	n_N	I_N	P_N	I_{max}	4.0	8.0	16.0	32.0	48.0	64.0
06C41-	0.6	4050	1.3	0.25	M_0	0.8					
					M_N	0.6					
					$M_{0,max}$	1.2					
					M_{max}	1.9					
					n_{eto}	2747					
06C60-	0.5	6000	2.4	0.31	M_0	0.6	0.8				
					M_N	0.4	0.5				
					$M_{0,max}$	0.6	1.2				
					M_{max}	1.0	1.9				
					n_{eto}	7000	6814				
06F41-	1.2	4050	1.5	0.51	M_0	1.5					
					M_N	1.2					
					$M_{0,max}$	2.0					
					M_{max}	3.6					
					n_{eto}	1902					
06F60-	0.9	6000	2.5	0.57	M_0	1.0	1.5				
					M_N	0.7	0.9				
					$M_{0,max}$	1.0	2.0				
					M_{max}	1.8	3.7				
					n_{eto}	7000	4602				
06I41-	1.5	4050	1.6	0.64	M_0	2.0	2.0				
					M_N	1.5	1.5				
					$M_{0,max}$	2.6	5.0				
					M_{max}	4.4	6.2				
					n_{eto}	1898	1384				
06I60-	1.2	6000	2.9	0.75	M_0	1.2	2.0	2.0			
					M_N	0.8	1.2	1.2			
					$M_{0,max}$	1.3	2.6	5.2			
					M_{max}	2.2	4.7	6.2			
					n_{eto}	6407	4200	3157			
09D41-	2.3	4050	2.3	1.00	M_0		3.3	3.3			
					M_N		2.3	2.3			
					$M_{0,max}$		5.0	8.8			
					M_{max}		8.0	9.4			
					n_{eto}		2361	2008			
09D60-	1.8	6000	3.8	1.10	M_0		2.5	3.3			
					M_N		1.8	1.8			
					$M_{0,max}$		2.5	4.9			
					M_{max}		4.4	8.0			
					n_{eto}		7000	5217			
09F38-	3.1	3750	2.5	1.20	M_0		4.2	4.2			
					M_N		3.1	3.1			
					$M_{0,max}$		6.2	10.8			
					M_{max}		9.8	14.9			
					n_{eto}		2589	1737			

- I... [A], M... [Nm], n... [r/min], P... [kW]

MCS synchronous servo motors

Technical data



Selection tables, Servo Drives ECS

Non-ventilated motors

- The data applies to a mains connection voltage of 3 x 400 V and an inverter switching frequency of 4 kHz.

					ECS□□	004C□B	008C□B	016C□B	032C□B	048C□B	064C□B
					I_N	2.0	4.0	8.0	12.7	17.0	20.0
					$I_{0,max}$	2.3	4.6	9.1	18.1	27.2	36.3
MCS	M_N	n_N	I_N	P_N	I_{max}	4.0	8.0	16.0	32.0	48.0	64.0
09F60-	2.4	6000	4.5	1.50	M_0		2.8	4.2	4.2		
					M_N		2.1	2.4	2.4		
					$M_{0,max}$		3.2	6.1	10.8		
					M_{max}		5.4	9.8	14.9		
					n_{eto}		7000	5906	3715		
09H41-	3.8	4050	3.4	1.60	M_0		5.2	5.5			
					M_N		3.8	3.8			
					$M_{0,max}$		5.9	11.1			
					M_{max}		9.9	17.5			
					n_{eto}		3675	2231			
09H60-	3.0	6000	6.0	1.90	M_0			5.2	5.5	5.5	
					M_N			3.0	3.0	3.0	
					$M_{0,max}$			5.9	11.0	15.5	
					M_{max}			9.9	17.5	20.4	
					n_{eto}			7000	5061	4375	
09L41-	4.5	4050	4.2	1.90	M_0		4.8	7.5	7.5		
					M_N		4.3	4.5	4.5		
					$M_{0,max}$		5.2	10.3	19.5		
					M_{max}		9.1	17.4	31.9		
					n_{eto}		4450	3188	1878		
09L51-	3.6	5100	6.9	1.90	M_0			4.8	7.5	7.5	7.5
					M_N			3.6	3.6	3.6	3.6
					$M_{0,max}$			5.2	10.3	15.1	19.6
					M_{max}			9.1	17.5	25.1	31.9
					n_{eto}			7000	7000	5647	4076
12D20-	5.5	1950	2.6	1.10	M_0	4.7	6.4	6.4			
					M_N	4.2	5.5	5.5			
					$M_{0,max}$	4.6	9.1	17.0			
					M_{max}	8.0	15.3	17.7			
					n_{eto}	1730	1089	919			
12D41-	4.3	4050	4.5	1.80	M_0		4.7	6.4			
					M_N		3.8	4.3			
					$M_{0,max}$		4.6	8.8			
					M_{max}		7.8	14.7			
					n_{eto}		3902	2433			
12H15-	10.0	1500	3.8	1.60	M_0		11.2	11.4			
					M_N		10.0	10.0			
					$M_{0,max}$		11.9	22.6			
					M_{max}		20.1	29.0			
					n_{eto}		1220	918			
12H35-	7.5	3525	5.7	2.80	M_0		5.6	11.2	11.4		
					M_N		5.3	7.5	7.5		
					$M_{0,max}$		6.0	11.8	22.5		
					M_{max}		10.4	20.1	29.0		
					n_{eto}		3850	2838	2092		

- $I...$ [A], $M...$ [Nm], $n...$ [r/min], $P...$ [kW]

MCS synchronous servo motors

Technical data



Selection tables, Servo Drives ECS

Non-ventilated motors

- The data applies to a mains connection voltage of 3 x 400 V and an inverter switching frequency of 4 kHz.

					ECS□□	004C□B	008C□B	016C□B	032C□B	048C□B	064C□B
					I_N	2.0	4.0	8.0	12.7	17.0	20.0
					$I_{0,max}$	2.3	4.6	9.1	18.1	27.2	36.3
MCS	M_N	n_N	I_N	P_N	I_{max}	4.0	8.0	16.0	32.0	48.0	64.0
12L20-	13.5	1950	5.9	2.80	M_0			15.0	15.0		
					M_N			13.5	13.5		
					$M_{0,max}$			21.4	39.4		
					M_{max}			35.5	56.4		
					n_{eto}			1324	863		
12L41-	11.0	4050	10.2	4.70	M_0			9.7	15.0	15.0	15.0
					M_N			8.6	11.0	11.0	11.0
					$M_{0,max}$			10.8	21.3	30.8	39.5
					M_{max}			19.0	35.5	49.6	56.4
					n_{eto}			4450	3013	2236	1907
14D15-	9.2	1500	4.5	1.45	M_0		8.8	11.0			
					M_N		8.2	9.2			
					$M_{0,max}$		9.6	17.9			
					M_{max}		15.9	28.3			
					n_{eto}		1141	689			
14D36-	7.5	3600	7.5	2.80	M_0			8.8	11.0		
					M_N			7.5	7.5		
					$M_{0,max}$			9.5	17.8		
					M_{max}			15.9	28.3		
					n_{eto}			2496	1614		
14H15-	16.0	1500	6.6	2.50	M_0			19.8	21.0		
					M_N			16.0	16.0		
					$M_{0,max}$			22.3	41.2		
					M_{max}			37.1	54.8		
					n_{eto}			920	667		
14H32-	14.0	3225	11.9	4.70	M_0				15.8	21.0	21.0
					M_N				14.0	14.0	14.0
					$M_{0,max}$				22.2	32.1	41.3
					M_{max}				37.1	51.9	54.8
					n_{eto}				1953	1471	1409
14L15-	23.0	1500	9.7	3.60	M_0			18.7	28.0	28.0	
					M_N			19.0	23.0	23.0	
					$M_{0,max}$			21.9	42.1	59.9	
					M_{max}			37.6	68.5	77.1	
					n_{eto}			1284	828	767	
14L32-	17.2	3225	15.0	5.80	M_0				14.8	19.8	23.3
					M_N				14.6	17.2	17.2
					$M_{0,max}$				21.8	32.4	42.2
					M_{max}				37.6	53.9	68.5
					n_{eto}				2801	2096	1757
14P14-	30.0	1350	10.8	4.20	M_0				37.0	37.0	37.0
					M_N				30.0	30.0	30.0
					$M_{0,max}$				49.1	70.0	88.4
					M_{max}				80.0	105.1	105.1
					n_{eto}				710	573	573

- $I...$ [A], $M...$ [Nm], $n...$ [r/min], $P...$ [kW]

MCS synchronous servo motors

Technical data



Selection tables, Servo Drives ECS

Non-ventilated motors

- The data applies to a mains connection voltage of 3 x 400 V and an inverter switching frequency of 4 kHz.

					ECS□□	004C□B	008C□B	016C□B	032C□B	048C□B	064C□B
					I_N	2.0	4.0	8.0	12.7	17.0	20.0
					$I_{0,max}$	2.3	4.6	9.1	18.1	27.2	36.3
MCS	M_N	n_N	I_N	P_N	I_{max}	4.0	8.0	16.0	32.0	48.0	64.0
14P32-	21.0	3225	15.6	7.10	M_0				19.3	25.9	30.5
					M_N				17.1	21.0	21.0
					$M_{0,max}$				25.4	37.9	49.3
					M_{max}				43.9	63.0	80.0
					n_{eto}				2469	1829	1495
19F14-	27.0	1425	8.6	4.00	M_0			25.9	32.0		
					M_N			25.1	27.0		
					$M_{0,max}$			28.6	54.6		
					M_{max}			48.9	86.0		
					n_{eto}			1204	746		
19F30-	21.0	3000	14.0	6.60	M_0				20.5	27.5	32.0
					M_N				19.0	21.0	21.0
					$M_{0,max}$				27.2	40.5	53.0
					M_{max}				47.2	68.3	86.0
					n_{eto}				2774	2033	1653
19J14-	40.0	1425	12.3	6.00	M_0				42.6	51.0	
					M_N				40.0	40.0	
					$M_{0,max}$				58.9	82.8	
					M_{max}				96.0	129.0	
					n_{eto}				1063	839	
19J30-	29.0	3000	18.5	9.10	M_0					28.4	33.4
					M_N					26.6	29.0
					$M_{0,max}$					42.6	56.9
					M_{max}					73.8	96.0
					n_{eto}					2850	2323
19P14-	51.0	1350	14.3	7.20	M_0				46.4	62.2	64.0
					M_N				45.3	51.0	51.0
					$M_{0,max}$				64.6	91.5	120.1
					M_{max}				106.7	155.5	190.0
					n_{eto}				1227	996	870
19P30-	32.0	3000	19.0	10.00	M_0					31.2	36.7
					M_N					28.6	32.0
					$M_{0,max}$					45.8	61.1
					M_{max}					81.2	106.7
					n_{eto}					2938	2715

- $I...$ [A], $M...$ [Nm], $n...$ [r/min], $P...$ [kW]

MCS synchronous servo motors

Technical data



Selection tables, Servo Drives ECS

Non-ventilated motors

- The data applies to a mains connection voltage of 3x230V and an inverter switching frequency of 4 kHz.

					ECS□□	004C□B	008C□B	016C□B	032C□B	048C□B	064C□B
					I_N	2.0	4.0	8.0	12.7	17.0	20.0
					$I_{0,max}$	2.3	4.6	9.1	18.1	27.2	36.3
MCS	M_N	n_N	I_N	P_N	I_{max}	4.0	8.0	16.0	32.0	48.0	64.0
06C41L	0.6	4050	2.6	0.25	M_0	0.6	0.8				
					M_N	0.5	0.6				
					$M_{0,max}$	0.6	1.1				
					M_{max}	1.0	1.9				
					n_{eto}	6298	2835				
06C60L	0.5	6000	4.0	0.31	M_0		0.7	0.8			
					M_N		0.5	0.5			
					$M_{0,max}$		0.7	1.3			
					M_{max}		1.2	2.2			
					n_{eto}		7000	1149			
06F41L	1.2	4050	2.9	0.51	M_0	1.0	1.5	1.5			
					M_N	0.8	1.2	1.2			
					$M_{0,max}$	1.2	2.1	3.9			
					M_{max}	1.9	3.5	4.4			
					n_{eto}	3838	2118	2831			
06F60L	0.9	6000	3.8	0.57	M_0		1.5	1.5			
					M_N		0.9	0.9			
					$M_{0,max}$		1.5	2.9			
					M_{max}		2.6	4.3			
					n_{eto}		6138	3182			
06I41L	1.5	4050	3.2	0.64	M_0	1.3	2.0	2.0			
					M_N	1.0	1.5	1.5			
					$M_{0,max}$	1.4	2.8	5.0			
					M_{max}	2.4	4.4	6.2			
					n_{eto}	3549	1947	2831			
06I60L	1.2	6000	3.8	0.75	M_0		1.9	2.0			
					M_N		1.2	1.2			
					$M_{0,max}$		2.1	4.1			
					M_{max}		3.6	6.2			
					n_{eto}		3417	1149			
09D41L	2.3	4050	4.6	1.00	M_0		2.5	3.3	3.3		
					M_N		2.0	2.3	2.3		
					$M_{0,max}$		2.5	4.9	8.8		
					M_{max}		4.4	8.0	9.5		
					n_{eto}		4091	2547	2170		
09D60L	1.8	6000	7.0	1.10	M_0			2.6	3.3	3.3	
					M_N			1.8	1.8	1.8	
					$M_{0,max}$			2.6	5.0	7.1	
					M_{max}			4.5	8.1	9.5	
					n_{eto}			7000	5373	4626	
09F38L	3.1	3750	5.0	1.20	M_0			4.2	4.2		
					M_N			3.1	3.1		
					$M_{0,max}$			6.1	10.8		
					M_{max}			9.8	15.0		
					n_{eto}			1149	1951		

- $I...$ [A], $M...$ [Nm], $n...$ [r/min], $P...$ [kW]

MCS synchronous servo motors

Technical data



Selection tables, Servo Drives ECS

Non-ventilated motors

- The data applies to a mains connection voltage of 3x230V and an inverter switching frequency of 4 kHz.

					ECS□□	004C□B	008C□B	016C□B	032C□B	048C□B	064C□B
					I_N	2.0	4.0	8.0	12.7	17.0	20.0
					$I_{0,max}$	2.3	4.6	9.1	18.1	27.2	36.3
MCS	M_N	n_N	I_N	P_N	I_{max}	4.0	8.0	16.0	32.0	48.0	64.0
09F60L	2.4	6000	7.9	1.50	M_0			3.2	4.2	4.2	4.2
					M_N			2.4	2.4	2.4	2.4
					$M_{0,max}$			3.6	6.8	9.6	11.9
					M_{max}			6.1	10.9	14.3	15.0
					n_{eto}			6985	3448	2612	2397
09H41L	3.8	4050	6.8	1.60	M_0			5.2	5.5	5.5	
					M_N			3.8	3.8	3.8	
					$M_{0,max}$			5.9	11.0	15.3	
					M_{max}			9.9	17.2	20.0	
					n_{eto}			1149	2138	1852	
09H60L	3.0	6000	8.0	1.90	M_0			3.7	5.5	5.5	5.5
					M_N			3.0	3.0	3.0	3.0
					$M_{0,max}$			4.1	8.0	11.5	14.5
					M_{max}			7.2	13.2	17.9	20.0
					n_{eto}			1149	4081	2984	2695
09L41L	4.5	4050	8.4	1.90	M_0			4.8	7.5	7.5	7.5
					M_N			4.3	4.5	4.5	4.5
					$M_{0,max}$			5.2	10.3	15.1	19.6
					M_{max}			9.1	17.5	25.1	31.9
					n_{eto}			4562	3243	2497	1909
12D20L	5.5	1950	5.2	1.10	M_0		4.7	6.4			
					M_N		4.2	5.5			
					$M_{0,max}$		4.6	9.0			
					M_{max}		8.0	14.9			
					n_{eto}		1878	1181			
12D41L	4.3	4050	8.8	1.80	M_0			4.8	6.4	6.4	
					M_N			3.9	4.3	4.3	
					$M_{0,max}$			4.6	9.2	13.3	
					M_{max}			8.1	15.2	17.9	
					n_{eto}			4102	2535	2187	
12H15L	10.0	1500	7.6	1.60	M_0			11.2	11.4		
					M_N			10.0	10.0		
					$M_{0,max}$			11.8	22.5		
					M_{max}			20.1	29.0		
					n_{eto}			1098	827		
12H30L	8.0	3000	10.5	2.50	M_0			6.8	10.7	11.4	
					M_N			6.1	8.0	8.0	
					$M_{0,max}$			7.2	14.3	20.9	
					M_{max}			12.7	24.3	29.0	
					n_{eto}			2831	1849	1591	
12L20L	13.5	1950	11.8	2.80	M_0				15.0	15.0	15.0
					M_N				13.5	13.5	13.5
					$M_{0,max}$				21.3	30.7	39.4
					M_{max}				35.4	49.3	56.0
					n_{eto}				1307	1004	866

- $I...$ [A], $M...$ [Nm], $n...$ [r/min], $P...$ [kW]

MCS synchronous servo motors

Technical data



Selection tables, Servo Drives ECS

Forced ventilated IP54 motors

- The data applies to a mains connection voltage of 3 x 400 V and an inverter switching frequency of 4 kHz.

					ECS□□	004C□B	008C□B	016C□B	032C□B	048C□B	064C□B
					I_N	2.0	4.0	8.0	12.7	17.0	20.0
					$I_{0,max}$	2.3	4.6	9.1	18.1	27.2	36.3
MCS	M_N	n_N	I_N	P_N	I_{max}	4.0	8.0	16.0	32.0	48.0	64.0
12D17-	7.0	1650	3.0	1.20	M_0	4.7	7.5	7.5			
					M_N	4.2	7.0	7.0			
					$M_{0,max}$	4.6	9.1	17.0			
					M_{max}	8.0	15.3	17.7			
					n_{eto}	1730	1089	919			
12D35-	6.0	3525	5.6	2.20	M_0		4.7	7.5			
					M_N		3.8	6.0			
					$M_{0,max}$		4.6	8.8			
					M_{max}		7.8	14.7			
					n_{eto}		3902	2433			
12H14-	12.0	1350	4.1	1.70	M_0		11.2	12.8			
					M_N		10.6	12.0			
					$M_{0,max}$		11.9	22.6			
					M_{max}		20.1	29.0			
					n_{eto}		1220	918			
12H34-	10.5	3375	7.5	3.70	M_0		5.6	11.2	12.8		
					M_N		5.3	10.0	7.5		
					$M_{0,max}$		6.0	11.8	22.5		
					M_{max}		10.4	20.1	29.0		
					n_{eto}		3850	2838	2092		
12L17-	17.0	1650	6.7	2.90	M_0			19.0	19.0		
					M_N			17.0	17.0		
					$M_{0,max}$			21.4	39.4		
					M_{max}			35.5	56.4		
					n_{eto}			1324	863		
12L39-	14.0	3900	11.7	5.70	M_0			9.7	16.7	19.0	19.0
					M_N			8.6	14.0	14.0	14.0
					$M_{0,max}$			10.8	21.3	30.8	39.5
					M_{max}			19.0	35.5	49.6	56.4
					n_{eto}			4450	3013	2236	1907
14D14-	12.0	1350	5.4	1.70	M_0		8.8	12.5			
					M_N		8.2	12.0			
					$M_{0,max}$		9.6	17.9			
					M_{max}		15.9	28.3			
					n_{eto}		1141	689			
14D30-	10.5	3000	9.7	3.30	M_0			8.8	11.4		
					M_N			8.6	9.7		
					$M_{0,max}$			9.5	17.8		
					M_{max}			15.9	28.3		
					n_{eto}			2496	1614		
14H12-	23.5	1200	8.3	3.00	M_0			19.8	25.5		
					M_N			19.6	23.5		
					$M_{0,max}$			22.3	41.2		
					M_{max}			37.1	54.8		
					n_{eto}			920	667		

- $I...$ [A], $M...$ [Nm], $n...$ [r/min], $P...$ [kW]

MCS synchronous servo motors

Technical data



Selection tables, Servo Drives ECS

Forced ventilated IP54 motors

- The data applies to a mains connection voltage of 3 x 400 V and an inverter switching frequency of 4 kHz.

					ECS□□	004C□B	008C□B	016C□B	032C□B	048C□B	064C□B
					I_N	2.0	4.0	8.0	12.7	17.0	20.0
					$I_{0,max}$	2.3	4.6	9.1	18.1	27.2	36.3
MCS	M_N	n_N	I_N	P_N	I_{max}	4.0	8.0	16.0	32.0	48.0	64.0
14H28-	20.5	2775	15.0	6.00	M_0				15.8	23.5	25.5
					M_N				15.6	20.5	20.5
					$M_{0,max}$				22.2	32.1	41.3
					M_{max}				37.1	51.9	54.8
					η_{eto}				1953	1471	1409
14L14-	30.5	1350	11.8	4.30	M_0			18.7	32.7	34.5	
					M_N			19.0	30.5	30.5	
					$M_{0,max}$			21.9	42.1	59.9	
					M_{max}			37.6	68.5	77.1	
					η_{eto}			1284	828	767	
14L30-	25.5	3000	20.8	8.00	M_0					19.8	23.3
					M_N					19.7	23.3
					$M_{0,max}$					32.4	42.2
					M_{max}					53.9	68.5
					η_{eto}					2096	1757
14P11-	42.0	1050	13.4	4.60	M_0				39.1	43.5	43.5
					M_N				38.9	42.0	42.0
					$M_{0,max}$				49.1	70.0	88.4
					M_{max}				80.0	105.1	105.1
					η_{eto}				710	573	573
14P26-	33.0	2625	21.9	9.10	M_0					25.9	30.5
					M_N					25.6	30.1
					$M_{0,max}$					37.9	49.3
					M_{max}					63.0	80.0
					η_{eto}					1829	1495
19F12-	38.0	1200	11.3	4.80	M_0			25.9	41.5		
					M_N			25.1	38.0		
					$M_{0,max}$			28.6	54.6		
					M_{max}			48.9	86.0		
					η_{eto}			1204	746		
19F29-	32.5	2850	20.1	9.70	M_0					27.5	33.9
					M_N					27.4	32.5
					$M_{0,max}$					40.5	53.0
					M_{max}					68.3	86.0
					η_{eto}					2033	1653
19J12-	62.5	1200	18.3	7.90	M_0					59.0	69.4
					M_N					58.1	62.5
					$M_{0,max}$					82.8	82.8
					M_{max}					129.0	129.0
					η_{eto}					839	839
19J29-	50.5	2850	31.0	15.10	M_0						34.3
					M_N						32.6
					$M_{0,max}$						56.9
					M_{max}						96.0
					η_{eto}						2323

- $I...$ [A], $M...$ [Nm], $n...$ [r/min], $P...$ [kW]

MCS synchronous servo motors

Technical data



Selection tables, Servo Drives ECS

Forced ventilated IP54 motors

- The data applies to a mains connection voltage of 3 x 400 V and an inverter switching frequency of 4 kHz.

					ECS□□	004C□B	008C□B	016C□B	032C□B	048C□B	064C□B
					I_N	2.0	4.0	8.0	12.7	17.0	20.0
					$I_{0,max}$	2.3	4.6	9.1	18.1	27.2	36.3
MCS	M_N	n_N	I_N	P_N	I_{max}	4.0	8.0	16.0	32.0	48.0	64.0
19P12-	72.0	1200	21.3	9.00	M_0					62.2	76.8
					M_N					57.5	67.6
					$M_{0,max}$					91.5	120.1
					M_{max}					155.5	190.0
					n_{eto}					996	870
19P29-	53.0	2850	29.5	15.80	M_0						36.7
					M_N						35.9
					$M_{0,max}$						61.1
					M_{max}						106.7
					n_{eto}						2715

- I... [A], M... [Nm], n... [r/min], P... [kW]

MCS synchronous servo motors

Technical data



Selection tables, Servo Inverter 9300

Non-ventilated motors

- The data applies to a mains connection voltage of 3 x 400 V and an inverter switching frequency of 8 kHz.

					EVS	9321- E□	9322- E□	9323- E□	9324- E□	9325- E□	9326- E□	9327- E□	9328- E□	9329- E□
					I_N	1.5	2.5	3.9	7.0	13.0	23.5	32.0	47.0	59.0
					$I_{0,max}$	2.3	3.8	5.9	10.5	19.5	23.5	32.0	47.0	52.0
MCS	M_N	n_N	I_N	P_N	I_{max}	2.3	3.8	5.9	10.5	19.5	35.3	48.0	70.5	88.5
06C41-	0.6	4050	1.3	0.25	M_0	0.8	0.8	0.8						
					M_N	0.6	0.6	0.6						
					$M_{0,max}$	1.2	1.8	2.4						
					M_{max}	1.2	1.8	2.4						
					n_{eto}	4635	2871	2019						
06C60-	0.5	6000	2.4	0.31	M_0		0.8	0.8	0.8					
					M_N		0.5	0.5	0.5					
					$M_{0,max}$		1.0	1.5	2.4					
					M_{max}		1.0	1.5	2.4					
					n_{eto}		7000	7000	5368					
06F41-	1.2	4050	1.5	0.51	M_0	1.5	1.5	1.5						
					M_N	1.2	1.2	1.2						
					$M_{0,max}$	2.0	3.4	4.4						
					M_{max}	2.0	3.4	4.4						
					n_{eto}	2819	1973	1562						
06F60-	0.9	6000	2.5	0.57	M_0		1.3	1.5	1.5					
					M_N		0.9	0.9	0.9					
					$M_{0,max}$		1.7	3.0	4.4					
					M_{max}		1.7	3.0	4.4					
					n_{eto}		7000	5714	3773					
06I41-	1.5	4050	1.6	0.64	M_0	1.8	2.0	2.0						
					M_N	1.4	1.5	1.5						
					$M_{0,max}$	2.6	4.2	6.2						
					M_{max}	2.6	4.2	6.2						
					n_{eto}	2994	1980	1384						
06I60-	1.2	6000	2.9	0.75	M_0		1.5	2.0	2.0					
					M_N		1.0	1.2	1.2					
					$M_{0,max}$		2.1	3.3	5.7					
					M_{max}		2.1	3.3	5.7					
					n_{eto}		7000	5486	3414					
09D41-	2.3	4050	2.3	1.00	M_0		3.1	3.3	3.3					
					M_N		2.3	2.3	2.3					
					$M_{0,max}$		4.2	6.2	9.4					
					M_{max}		4.2	6.2	9.4					
					n_{eto}		4895	2937	2008					
09D60-	1.8	6000	3.8	1.10	M_0			2.4	3.3	3.3				
					M_N			1.8	1.8	1.8				
					$M_{0,max}$			3.2	5.6	9.3				
					M_{max}			3.2	5.6	9.3				
					n_{eto}			7000	7000	4492				
09F38-	3.1	3750	2.5	1.20	M_0		3.5	4.2	4.2					
					M_N		3.1	3.1	3.1					
					$M_{0,max}$		5.2	7.7	12.0					
					M_{max}		5.2	7.7	12.0					
					n_{eto}		4000	3250	2173					

- I... [A], M... [Nm], n... [r/min], P... [kW]

MCS synchronous servo motors

Technical data



Selection tables, Servo Inverter 9300

Non-ventilated motors

- The data applies to a mains connection voltage of 3 x 400 V and an inverter switching frequency of 8 kHz.

					EVS	9321- E□	9322- E□	9323- E□	9324- E□	9325- E□	9326- E□	9327- E□	9328- E□	9329- E□	
					I _N	1.5	2.5	3.9	7.0	13.0	23.5	32.0	47.0	59.0	
					I _{0,max}	2.3	3.8	5.9	10.5	19.5	23.5	32.0	47.0	52.0	
MCS	M _N	n _N	I _N	P _N	I _{max}	2.3	3.8	5.9	10.5	19.5	35.3	48.0	70.5	88.5	
09F60-	2.4	6000	4.5	1.50	M ₀				4.2	4.2					
					M _N				2.4	2.4					
					M _{0,max}				6.9	11.4					
					M _{max}				6.9	11.4					
					n _{eto}				7000	5035					
09H41-	3.8	4050	3.4	1.60	M ₀			5.0	5.5	5.5					
					M _N			3.8	3.8	3.8					
					M _{0,max}			7.5	12.5	20.1					
					M _{max}			7.5	12.5	20.1					
					n _{eto}			4250	2977	1988					
09H60-	3.0	6000	6.0	1.90	M ₀				4.5	5.5					
					M _N				3.0	3.0					
					M _{0,max}				6.7	11.7					
					M _{max}				6.7	11.7					
					n _{eto}				7000	7000					
09L41-	4.5	4050	4.2	1.90	M ₀			4.7	7.5	7.5					
					M _N			4.2	4.5	4.5					
					M _{0,max}			6.7	11.7	20.8					
					M _{max}			6.7	11.7	20.8					
					n _{eto}			4450	4154	2796					
09L51-	3.6	5100	6.9	1.90	M ₀				4.2	7.5	7.5				
					M _N				3.6	3.6	3.6				
					M _{0,max}				6.0	11.1	13.2				
					M _{max}				6.0	11.1	19.1				
					n _{eto}				7000	7000	7000				
12D20-	5.5	1950	2.6	1.10	M ₀		5.9	6.4	6.4						
					M _N		5.3	5.5	5.5						
					M _{0,max}		7.6	11.6	17.7						
					M _{max}		7.6	11.6	17.7						
					n _{eto}		1790	1358	919						
12D41-	4.3	4050	4.5	1.80	M ₀			4.6	6.4	6.4					
					M _N			3.7	4.3	4.3					
					M _{0,max}			5.9	10.1	17.3					
					M _{max}			5.9	10.1	17.3					
					n _{eto}			4344	3275	2116					
12H15-	10.0	1500	3.8	1.60	M ₀			10.9	11.4	11.4					
					M _N			10.0	10.0	10.0					
					M _{0,max}			15.1	25.8	29.0					
					M _{max}			15.1	25.8	29.0					
					n _{eto}			1676	1013	918					
12H35-	7.5	3525	5.7	2.80	M ₀				9.8	11.4					
					M _N				7.5	7.5					
					M _{0,max}				13.5	24.1					
					M _{max}				13.5	24.1					
					n _{eto}				3618	2447					

- I... [A], M... [Nm], n... [r/min], P... [kW]

MCS synchronous servo motors

Technical data



Selection tables, Servo Inverter 9300

Non-ventilated motors

- The data applies to a mains connection voltage of 3 x 400 V and an inverter switching frequency of 8 kHz.

					EVS	9321- E□	9322- E□	9323- E□	9324- E□	9325- E□	9326- E□	9327- E□	9328- E□	9329- E□
					I _N	1.5	2.5	3.9	7.0	13.0	23.5	32.0	47.0	59.0
					I _{0,max}	2.3	3.8	5.9	10.5	19.5	23.5	32.0	47.0	52.0
MCS	M _N	n _N	I _N	P _N	I _{max}	2.3	3.8	5.9	10.5	19.5	35.3	48.0	70.5	88.5
12L20-	13.5	1950	5.9	2.80	M ₀				15.0	15.0				
					M _N				13.5	13.5				
					M _{0,max}				24.4	41.9				
					M _{max}				24.4	41.9				
					n _{eto}				1718	1158				
12L41-	11.0	4050	10.2	4.70	M ₀					15.0	15.0	15.0		
					M _N					11.0	11.0	11.0		
					M _{0,max}					22.8	27.0	35.5		
					M _{max}					22.8	38.5	49.6		
					n _{eto}					4287	2799	2236		
14D15-	9.2	1500	4.5	1.45	M ₀		8.5	11.0	11.0					
					M _N		8.0	9.2	9.2					
					M _{0,max}		12.1	20.2	29.0					
					M _{max}		12.1	20.2	29.0					
					n _{eto}		1437	928	676					
14D36-	7.5	3600	7.5	2.80	M ₀			7.7	11.0	11.0				
					M _N			7.0	7.5	7.5				
					M _{0,max}			10.9	19.0	22.2				
					M _{max}			10.9	19.0	29.0				
					n _{eto}			3479	2159	1593				
14H15-	16.0	1500	6.6	2.50	M ₀			17.3	21.0					
					M _N			16.0	16.0					
					M _{0,max}			25.4	43.9					
					M _{max}			25.4	43.9					
					n _{eto}			1247	800					
14H32-	14.0	3225	11.9	4.70	M ₀				16.2	21.0	21.0			
					M _N				14.0	14.0	14.0			
					M _{0,max}				23.8	28.2	37.1			
					M _{max}				23.8	40.2	51.9			
					n _{eto}				2875	1817	1471			
14L15-	23.0	1500	9.7	3.60	M ₀				28.0	28.0				
					M _N				23.0	23.0				
					M _{0,max}				45.0	52.9				
					M _{max}				45.0	73.8				
					n _{eto}				1126	788				
14L32-	17.2	3225	15.0	5.80	M ₀				15.2	27.4	28.0	28.0		
					M _N				14.9	17.2	17.2	17.2		
					M _{0,max}				23.5	28.3	37.6	52.9		
					M _{max}				23.5	41.0	53.9	73.9		
					n _{eto}				3953	2608	2096	1672		
14P14-	30.0	1350	10.8	4.20	M ₀				37.0	37.0	37.0			
					M _N				30.0	30.0	30.0			
					M _{0,max}				52.5	61.8	80.0			
					M _{max}				52.5	86.3	105.1			
					n _{eto}				998	668	573			

- I... [A], M... [Nm], n... [r/min], P... [kW]

MCS synchronous servo motors

Technical data



Selection tables, Servo Inverter 9300

Non-ventilated motors

- The data applies to a mains connection voltage of 3 x 400 V and an inverter switching frequency of 8 kHz.

					EVS	9321- E□	9322- E□	9323- E□	9324- E□	9325- E□	9326- E□	9327- E□	9328- E□	9329- E□
					I_N	1.5	2.5	3.9	7.0	13.0	23.5	32.0	47.0	59.0
					$I_{0,max}$	2.3	3.8	5.9	10.5	19.5	23.5	32.0	47.0	52.0
MCS	M_N	n_N	I_N	P_N	I_{max}	2.3	3.8	5.9	10.5	19.5	35.3	48.0	70.5	88.5
14P32-	21.0	3225	15.6	7.10	M_0					19.8	35.8	37.0	37.0	
					M_N					17.5	21.0	21.0	21.0	
					$M_{0,max}$					27.4	33.0	43.9	61.8	
					M_{max}					27.4	47.9	63.0	86.4	
					n_{eto}					3300	2299	1829	1404	
19F14-	27.0	1425	8.6	4.00	M_0				22.6	32.0	32.0			
					M_N				22.0	27.0	27.0			
					$M_{0,max}$				33.0	58.2	68.3			
					M_{max}				33.0	58.2	86.0			
					n_{eto}				1459	1056	746			
19F30-	21.0	3000	14.0	6.60	M_0					21.0	32.0	32.0		
					M_N					19.5	21.0	21.0		
					$M_{0,max}$					29.2	35.2	47.2		
					M_{max}					29.2	51.5	68.3		
					n_{eto}					3352	2573	2033		
19J14-	40.0	1425	12.3	6.00	M_0					43.6	51.0	51.0		
					M_N					40.0	40.0	40.0		
					$M_{0,max}$					60.8	72.4	96.0		
					M_{max}					60.8	104.5	129.0		
					n_{eto}					1376	996	839		
19J30-	29.0	3000	18.5	9.10	M_0						39.3	51.0	51.0	51.0
					M_N						29.0	29.0	29.0	29.0
					$M_{0,max}$						36.8	50.2	72.4	79.5
					M_{max}						55.2	73.8	104.7	127.6
					n_{eto}						3150	2850	2162	1817
19P14-	51.0	1350	14.3	7.20	M_0					47.5	64.0	64.0		
					M_N					46.4	51.0	51.0		
					$M_{0,max}$					69.5	79.6	106.7		
					M_{max}					69.5	116.7	155.5		
					n_{eto}					1400	1187	996		
19P30-	32.0	3000	19.0	10.00	M_0						43.1	58.7	64.0	64.0
					M_N						32.0	32.0	32.0	32.0
					$M_{0,max}$						39.6	53.9	79.6	87.6
					M_{max}						59.3	81.2	116.9	144.3
					n_{eto}						3000	2938	2638	2298

- I... [A], M... [Nm], n... [r/min], P... [kW]

MCS synchronous servo motors

Technical data



Selection tables, Servo Inverter 9300

Forced ventilated IP54 motors

- The data applies to a mains connection voltage of 3 x 400 V and an inverter switching frequency of 8 kHz.

					EVS	9322-E□	9323-E□	9324-E□	9325-E□	9326-E□	9327-E□	9328-E□	9329-E□
					I_N	2.5	3.9	7.0	13.0	23.5	32.0	47.0	59.0
					$I_{0,max}$	3.8	5.9	10.5	19.5	23.5	32.0	47.0	52.0
MCS	M_N	n_N	I_N	P_N	I_{max}	3.8	5.9	10.5	19.5	35.3	48.0	70.5	88.5
12D17-	7.0	1650	3.0	1.20	M_0	5.9	7.5	7.5					
					M_N	5.3	7.0	7.0					
					$M_{0,max}$	7.6	11.6	17.7					
					M_{max}	7.6	11.6	17.7					
					n_{eto}	1790	1358	919					
12D35-	6.0	3525	5.6	2.20	M_0		4.6	7.5	7.5				
					M_N		3.7	6.0	6.0				
					$M_{0,max}$		5.9	10.1	17.3				
					M_{max}		5.9	10.1	17.3				
					n_{eto}		4344	3275	2116				
12H14-	12.0	1350	4.1	1.70	M_0		10.9	12.8	12.8				
					M_N		10.3	12.0	12.0				
					$M_{0,max}$		15.1	25.8	29.0				
					M_{max}		15.1	25.8	29.0				
					n_{eto}		1676	1013	918				
12H34-	10.5	3375	7.5	3.70	M_0			9.8	12.8				
					M_N			9.6	10.5				
					$M_{0,max}$			13.5	24.1				
					M_{max}			13.5	24.1				
					n_{eto}			3618	2447				
12L17-	17.0	1650	6.7	2.90	M_0			18.5	19.0				
					M_N			17.0	17.0				
					$M_{0,max}$			24.4	41.9				
					M_{max}			24.4	41.9				
					n_{eto}			1718	1158				
12L39-	14.0	3900	11.7	5.70	M_0				17.2	19.0	19.0		
					M_N				14.0	14.0	14.0		
					$M_{0,max}$				22.8	27.0	35.5		
					M_{max}				22.8	38.5	49.6		
					n_{eto}				4287	2799	2236		
14D14-	12.0	1350	5.4	1.70	M_0		8.5	12.5	12.5				
					M_N		8.0	12.0	12.0				
					$M_{0,max}$		12.1	20.2	29.0				
					M_{max}		12.1	20.2	29.0				
					n_{eto}		1437	928	676				
14D30-	10.5	3000	9.7	3.30	M_0			7.7	12.5	12.5			
					M_N			7.0	10.0	10.0			
					$M_{0,max}$			10.9	19.0	22.2			
					M_{max}			10.9	19.0	29.0			
					n_{eto}			3479	2159	1593			
14H12-	23.5	1200	8.3	3.00	M_0			17.3	25.5				
					M_N			17.2	23.5				
					$M_{0,max}$			25.4	43.9				
					M_{max}			25.4	43.9				
					n_{eto}			1247	800				

- $I...$ [A], $M...$ [Nm], $n...$ [r/min], $P...$ [kW]

MCS synchronous servo motors

Technical data



Selection tables, Servo Inverter 9300

Forced ventilated IP54 motors

- The data applies to a mains connection voltage of 3 x 400 V and an inverter switching frequency of 8 kHz.

					EVS	9322-E□	9323-E□	9324-E□	9325-E□	9326-E□	9327-E□	9328-E□	9329-E□
					I_N	2.5	3.9	7.0	13.0	23.5	32.0	47.0	59.0
					$I_{0,max}$	3.8	5.9	10.5	19.5	23.5	32.0	47.0	52.0
MCS	M_N	n_N	I_N	P_N	I_{max}	3.8	5.9	10.5	19.5	35.3	48.0	70.5	88.5
14H28-	20.5	2775	15.0	6.00	M_0				16.2	25.5	25.5		
					M_N				16.1	20.5	20.5		
					$M_{0,max}$				23.8	28.2	37.1		
					M_{max}				23.8	40.2	51.9		
					n_{eto}					2875	1817	1471	
14L14-	30.5	1350	11.8	4.30	M_0				33.4	34.5			
					M_N				30.5	30.5			
					$M_{0,max}$				45.0	52.9			
					M_{max}				45.0	73.8			
					n_{eto}					1126	788		
14L30-	25.5	3000	20.8	8.00	M_0					27.4	34.5	34.5	
					M_N					25.5	25.5	25.5	
					$M_{0,max}$					28.3	37.6	52.9	
					M_{max}					41.0	53.9	73.9	
					n_{eto}						2608	2096	1672
14P11-	42.0	1050	13.4	4.60	M_0				40.1	43.5	43.5		
					M_N				40.0	42.0	42.0		
					$M_{0,max}$				52.5	61.8	80.0		
					M_{max}				52.5	86.3	105.1		
					n_{eto}					998	668	573	
14P26-	33.0	2625	21.9	9.10	M_0					35.8	43.5	43.5	
					M_N					33.0	33.0	33.0	
					$M_{0,max}$					33.0	43.9	61.8	
					M_{max}					47.9	63.0	86.4	
					n_{eto}						2299	1829	1404
19F12-	38.0	1200	11.3	4.80	M_0			22.6	41.5	41.5			
					M_N			22.0	38.0	38.0			
					$M_{0,max}$			33.0	58.2	68.3			
					M_{max}			33.0	58.2	86.0			
					n_{eto}				1459	1056	746		
19F29-	32.5	2850	20.1	9.70	M_0					39.9	41.5		
					M_N					32.5	32.5		
					$M_{0,max}$					35.2	47.2		
					M_{max}					51.5	68.3		
					n_{eto}						2573	2033	
19J12-	62.5	1200	18.3	7.90	M_0				43.6	70.5	70.5		
					M_N				43.4	62.5	62.5		
					$M_{0,max}$				60.8	72.4	96.0		
					M_{max}				60.8	104.5	129.0		
					n_{eto}					1376	996	839	
19J29-	50.5	2850	31.0	15.10	M_0						55.5	70.5	70.5
					M_N						50.5	50.5	50.5
					$M_{0,max}$						50.2	72.4	79.5
					M_{max}						73.8	104.7	127.6
					n_{eto}							2850	2162

- $I...$ [A], $M...$ [Nm], $n...$ [r/min], $P...$ [kW]

MCS synchronous servo motors

Technical data



Selection tables, Servo Inverter 9300

Forced ventilated IP54 motors

- The data applies to a mains connection voltage of 3 x 400 V and an inverter switching frequency of 8 kHz.

					EVS	9322-E□	9323-E□	9324-E□	9325-E□	9326-E□	9327-E□	9328-E□	9329-E□		
					I_N	2.5	3.9	7.0	13.0	23.5	32.0	47.0	59.0		
					$I_{0,max}$	3.8	5.9	10.5	19.5	23.5	32.0	47.0	52.0		
MCS	M_N	n_N	I_N	P_N	I_{max}	3.8	5.9	10.5	19.5	35.3	48.0	70.5	88.5		
19P12-	72.0	1200	21.3	9.00	M_0				47.5	86.0	86.0				
					M_N				46.4	72.0	72.0				
					$M_{0,max}$				69.5	79.6	106.7				
					M_{max}				69.5	116.7	155.5				
					η_{eto}							1400	1187	996	
19P29-	53.0	2850	29.5	15.80	M_0						58.7	86.0	86.0		
					M_N						53.0	53.0	53.0		
					$M_{0,max}$						53.9	79.6	87.6		
					M_{max}								81.2	116.9	144.3
					η_{eto}								2938	2638	2298

- I... [A], M... [Nm], n... [r/min], P... [kW]

MCS synchronous servo motors

Technical data



Torque characteristics

► The data applies to a mains connection voltage of 3 x 400 V.

MCS06C41- (non-ventilated)

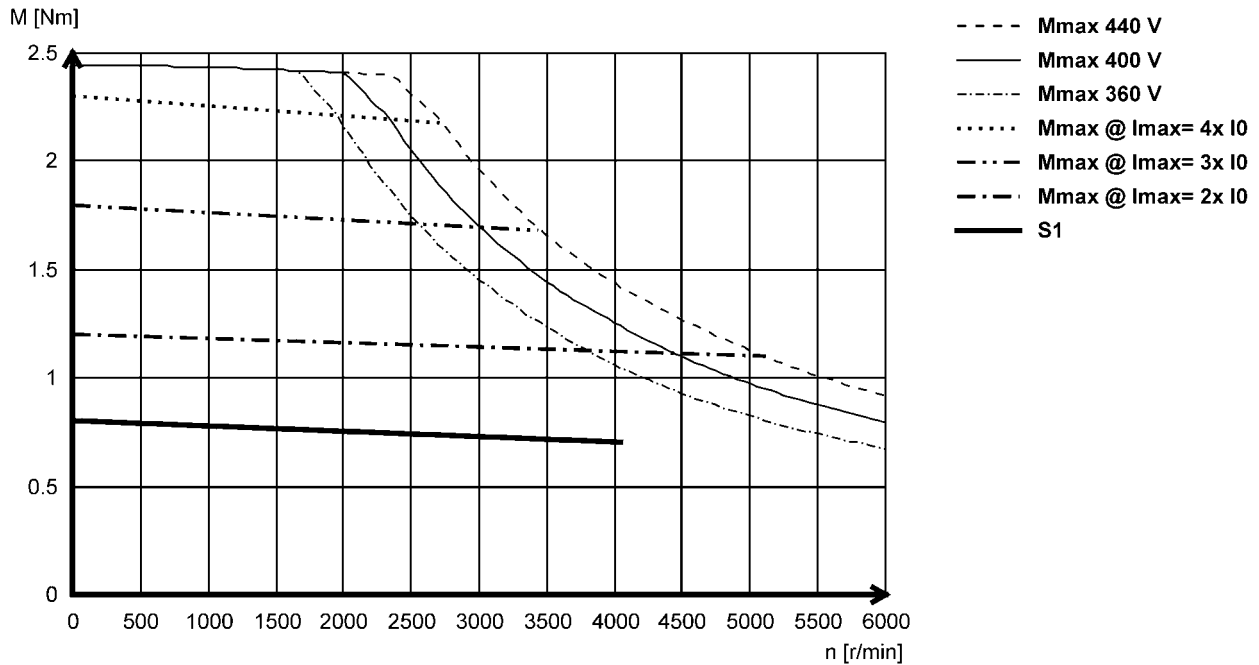

5.1

MCS06C60- (non-ventilated)

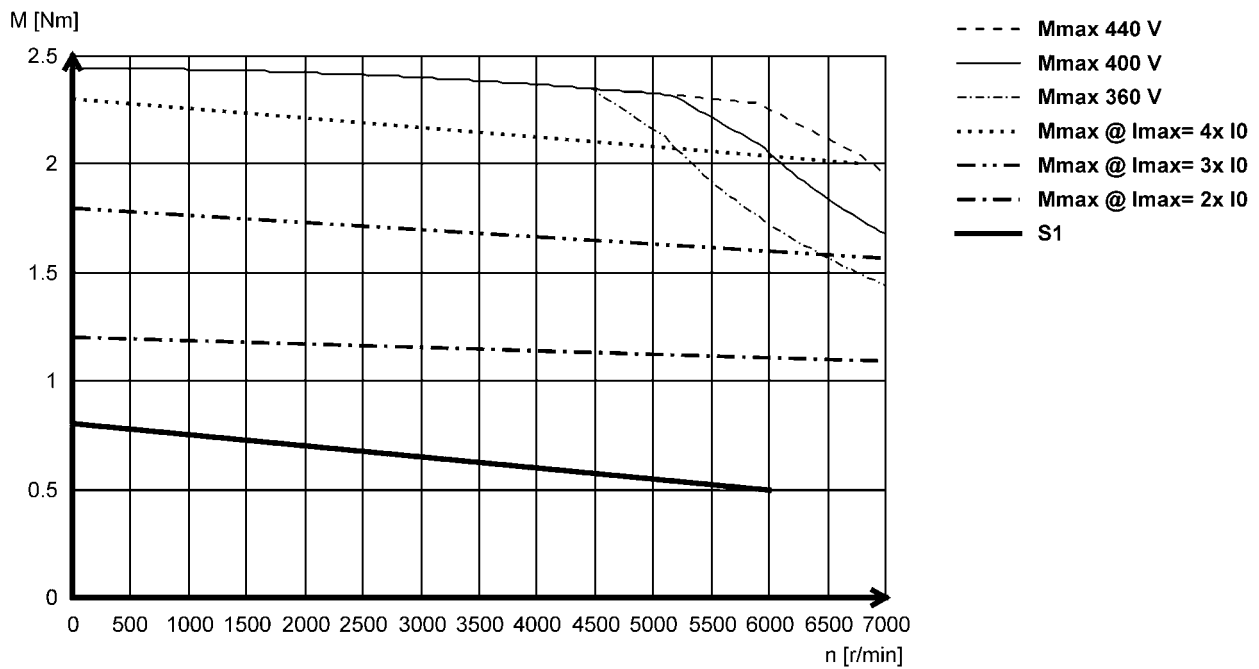

MCS synchronous servo motors

Technical data



Torque characteristics

► The data applies to a mains connection voltage of 3 x 400 V.

MCS06F41- (non-ventilated)

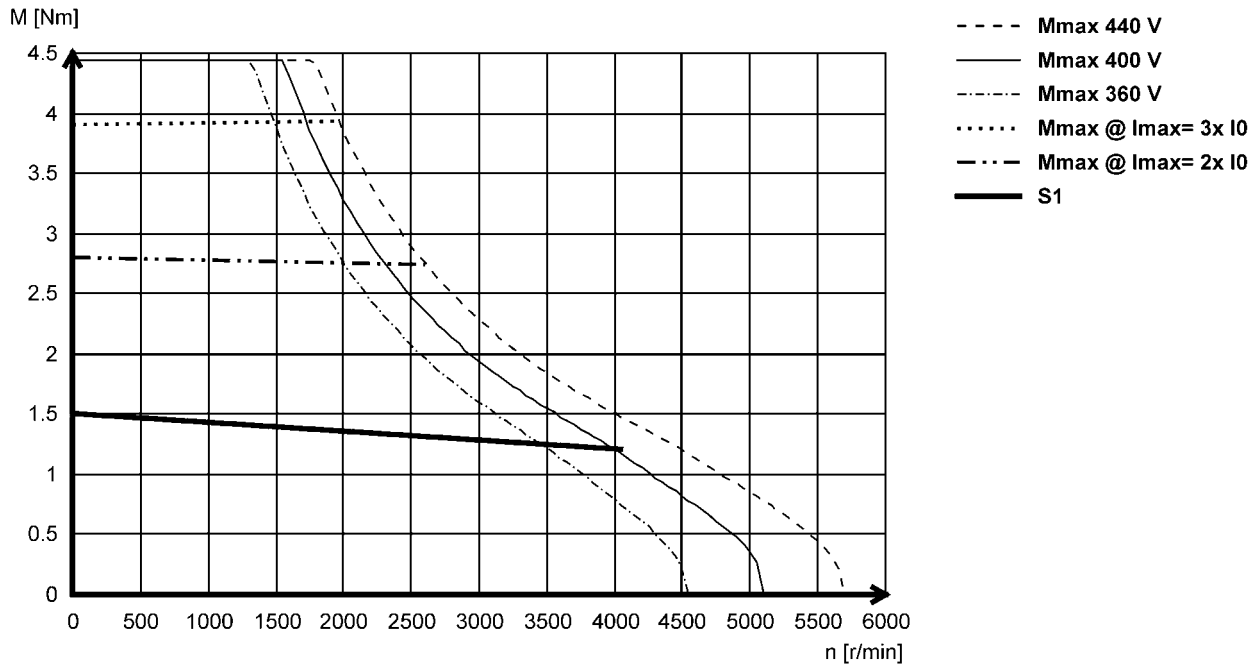

5.1

MCS06F60- (non-ventilated)

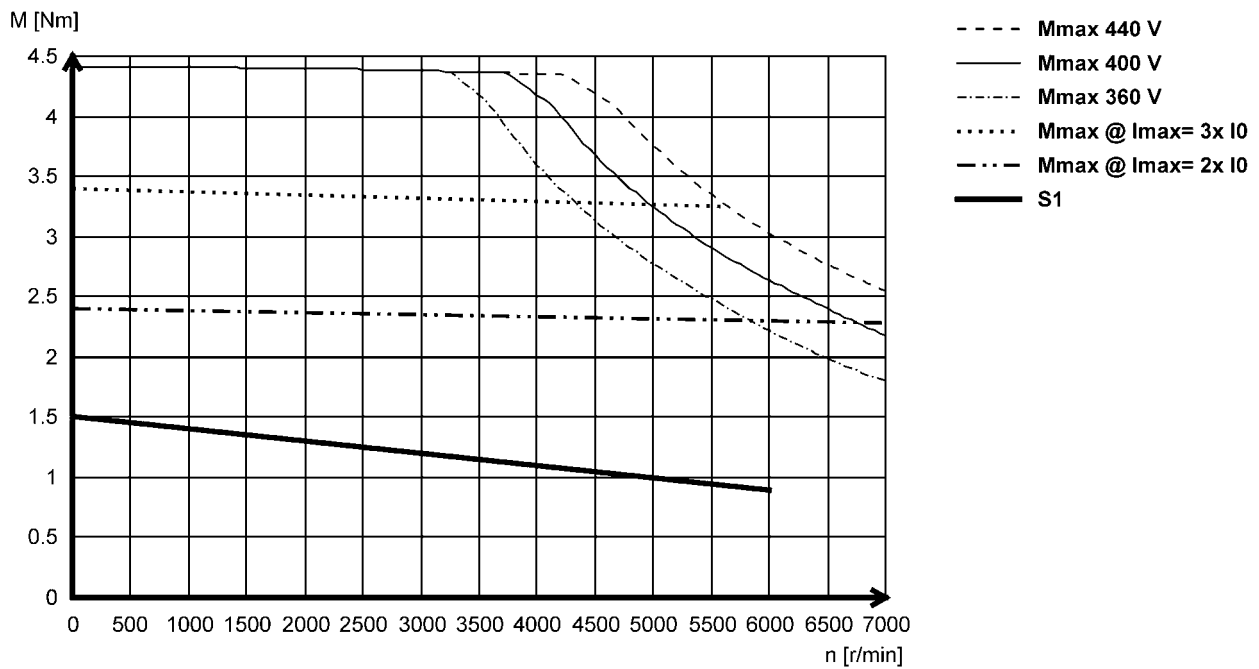

MCS synchronous servo motors

Technical data



Torque characteristics

► The data applies to a mains connection voltage of 3 x 400 V.

MCS06I41- (non-ventilated)

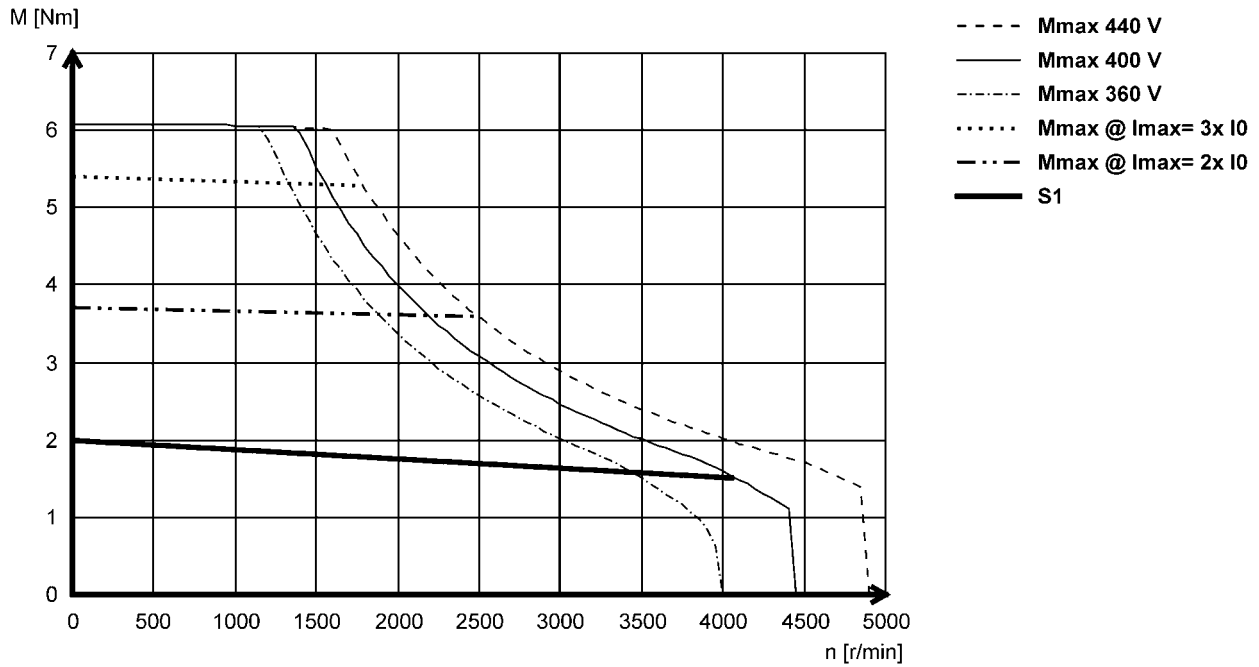

5.1

MCS06I60- (non-ventilated)

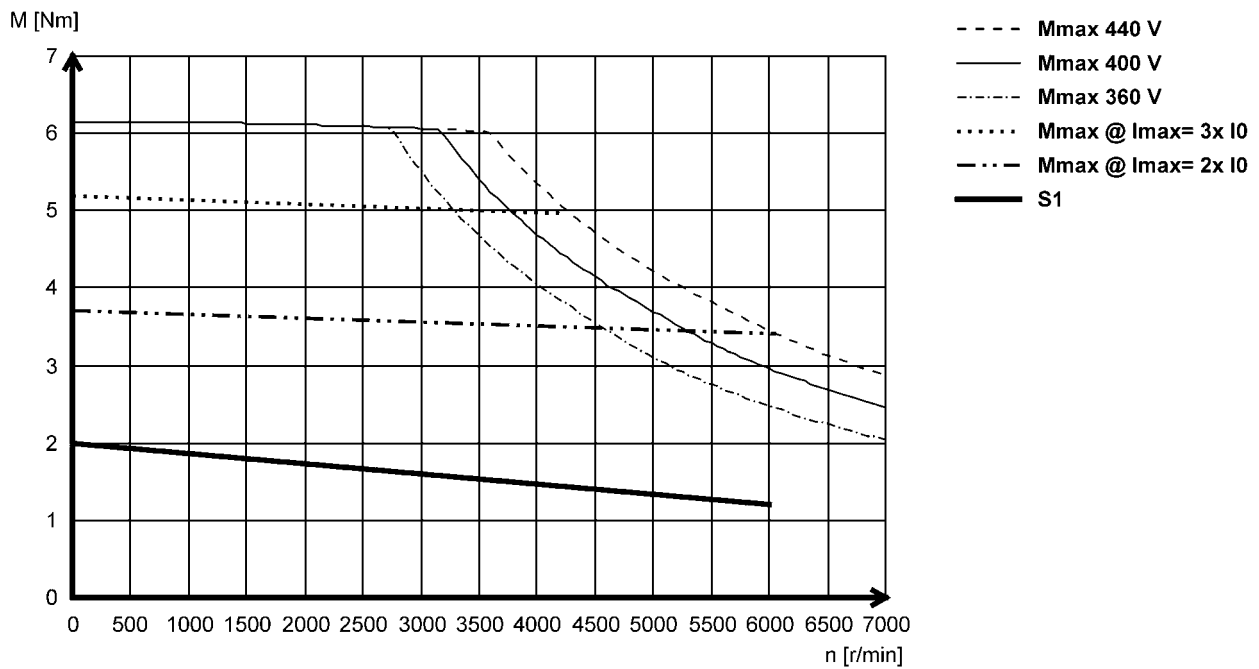

MCS synchronous servo motors

Technical data



Torque characteristics

► The data applies to a mains connection voltage of 3 x 400 V.

MCS09D41- (non-ventilated)

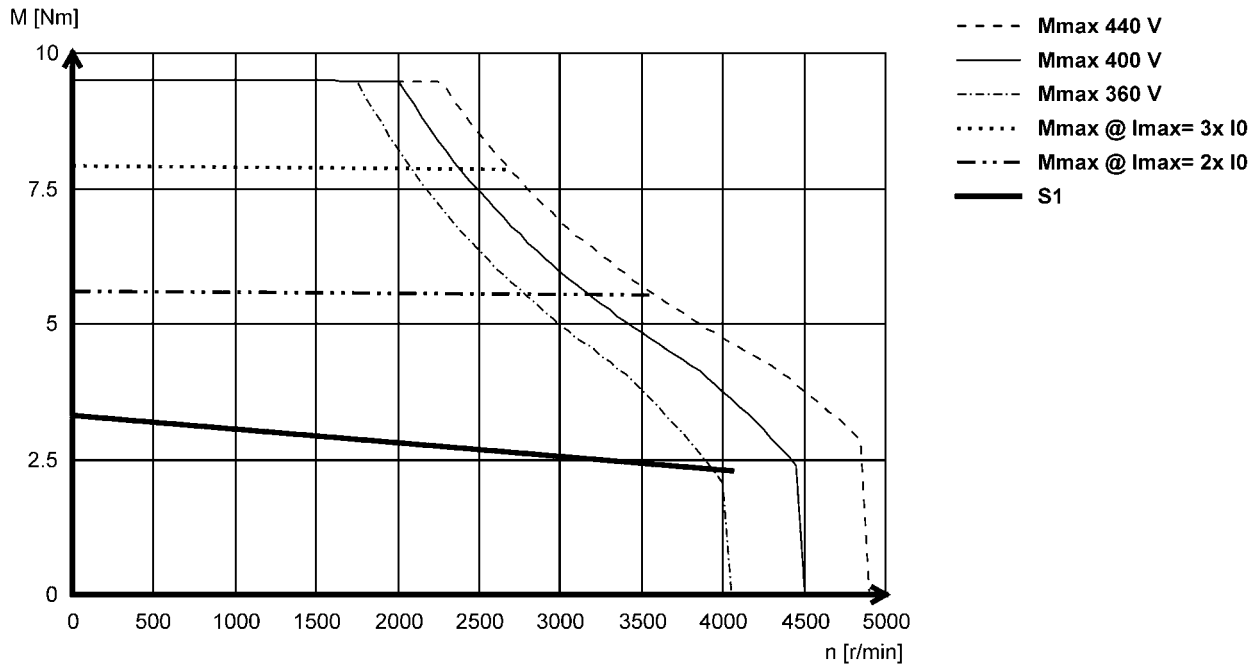

5.1

MCS09D60- (non-ventilated)

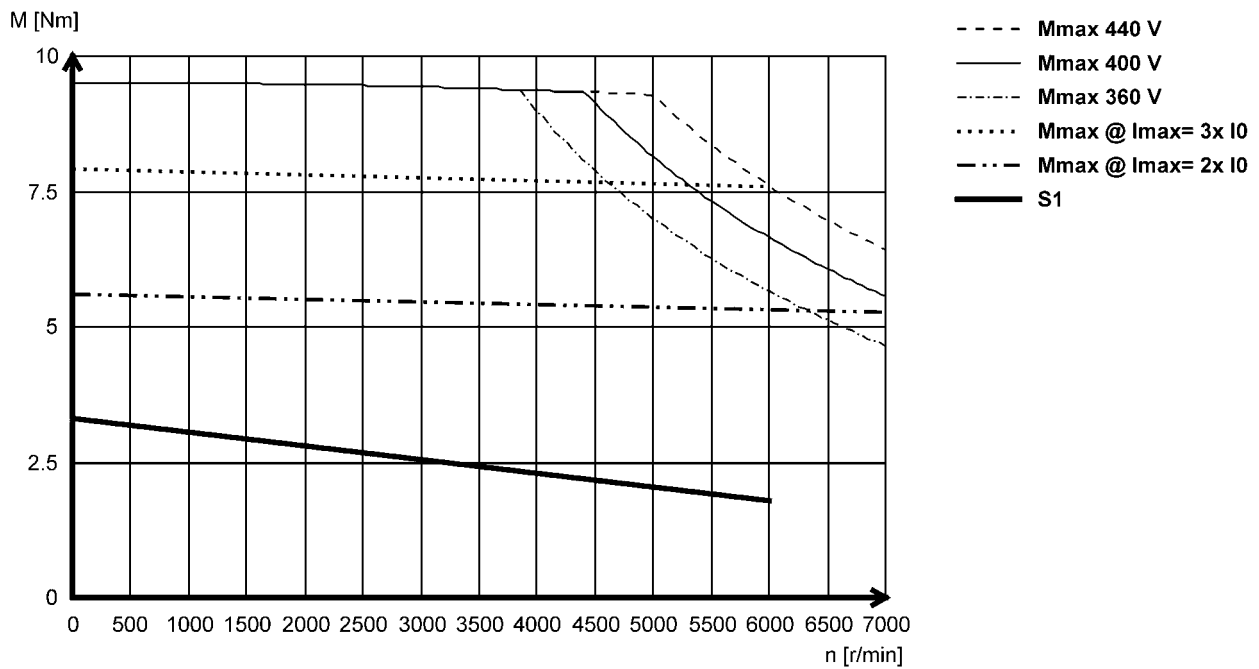

MCS synchronous servo motors

Technical data



Torque characteristics

► The data applies to a mains connection voltage of 3 x 400 V.

MCS09F38- (non-ventilated)

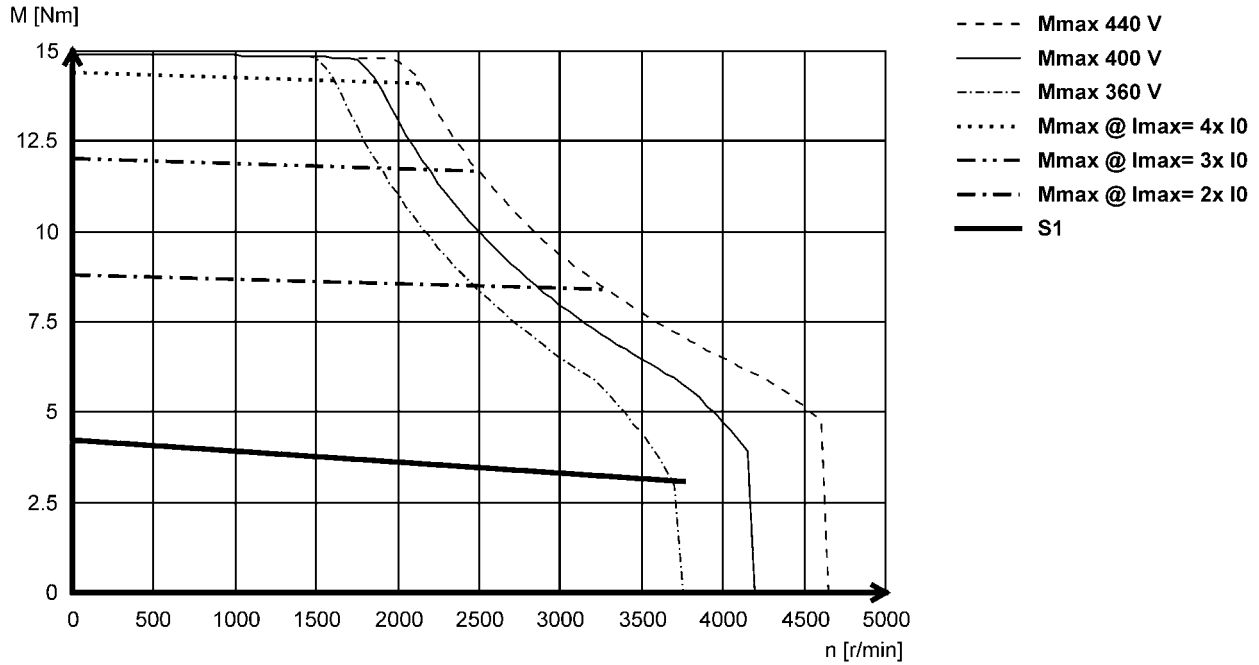

5.1

MCS09F60- (non-ventilated)

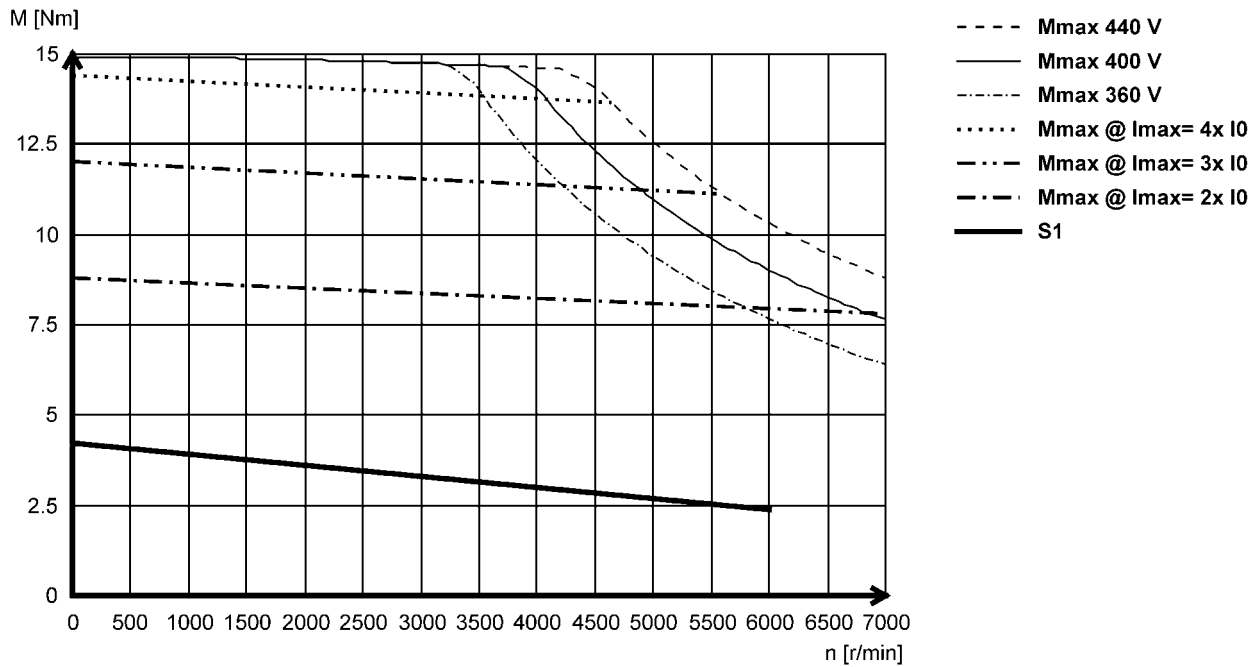

MCS synchronous servo motors

Technical data



Torque characteristics

► The data applies to a mains connection voltage of 3 x 400 V.

MCS09H41- (non-ventilated)

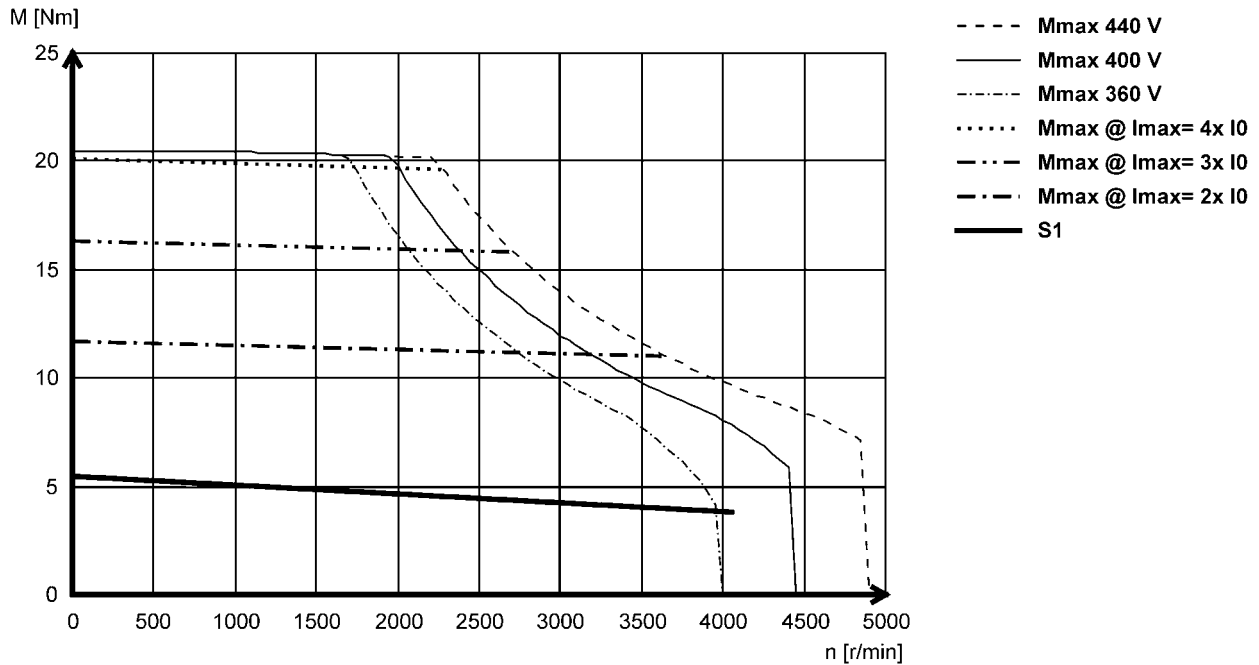

5.1

MCS09H60- (non-ventilated)

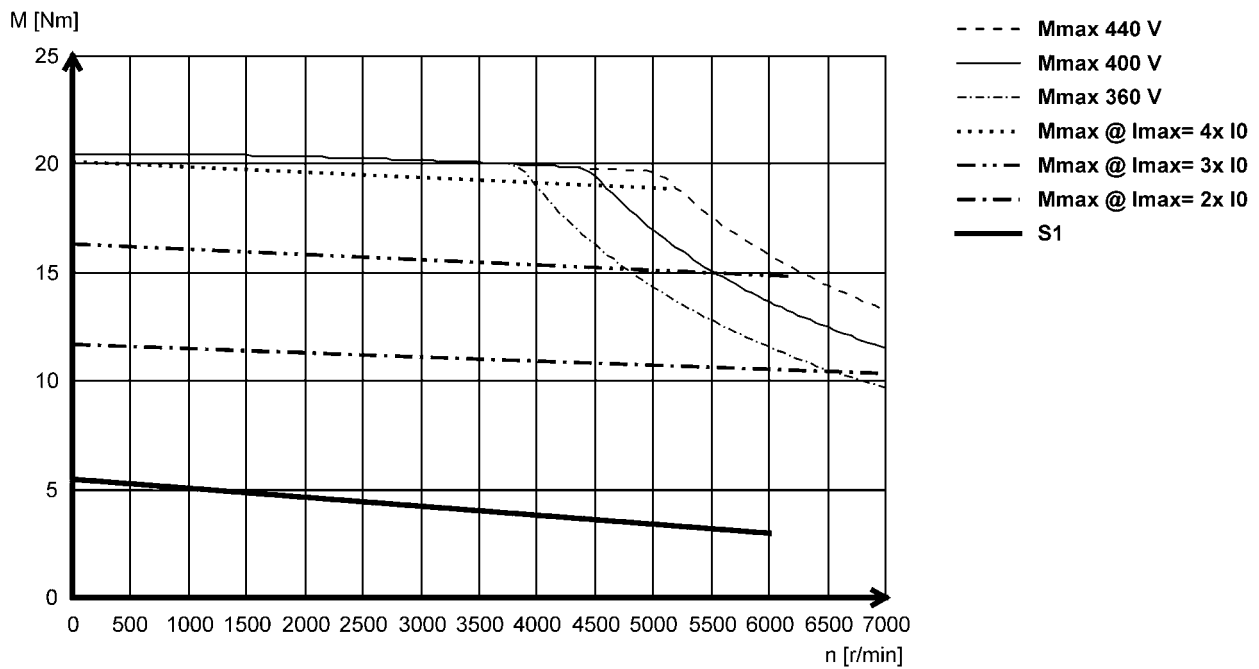

MCS synchronous servo motors

Technical data



Torque characteristics

► The data applies to a mains connection voltage of 3 x 400 V.

MCS09L41- (non-ventilated)

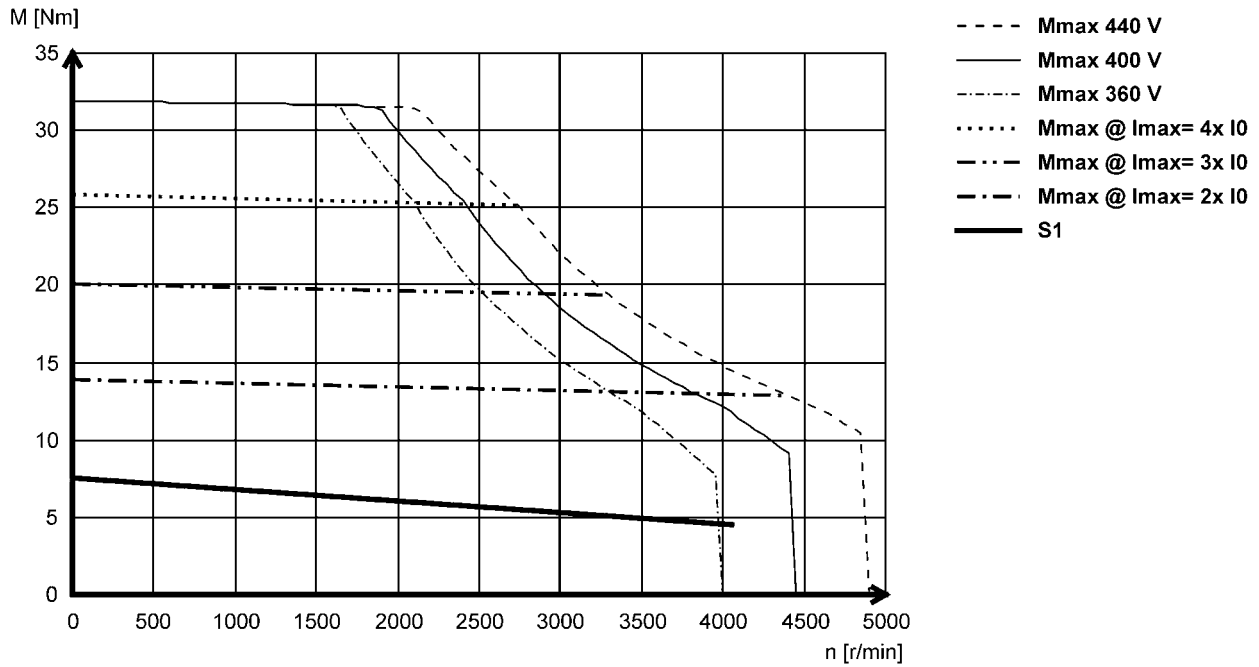

5.1

MCS09L51- (non-ventilated)

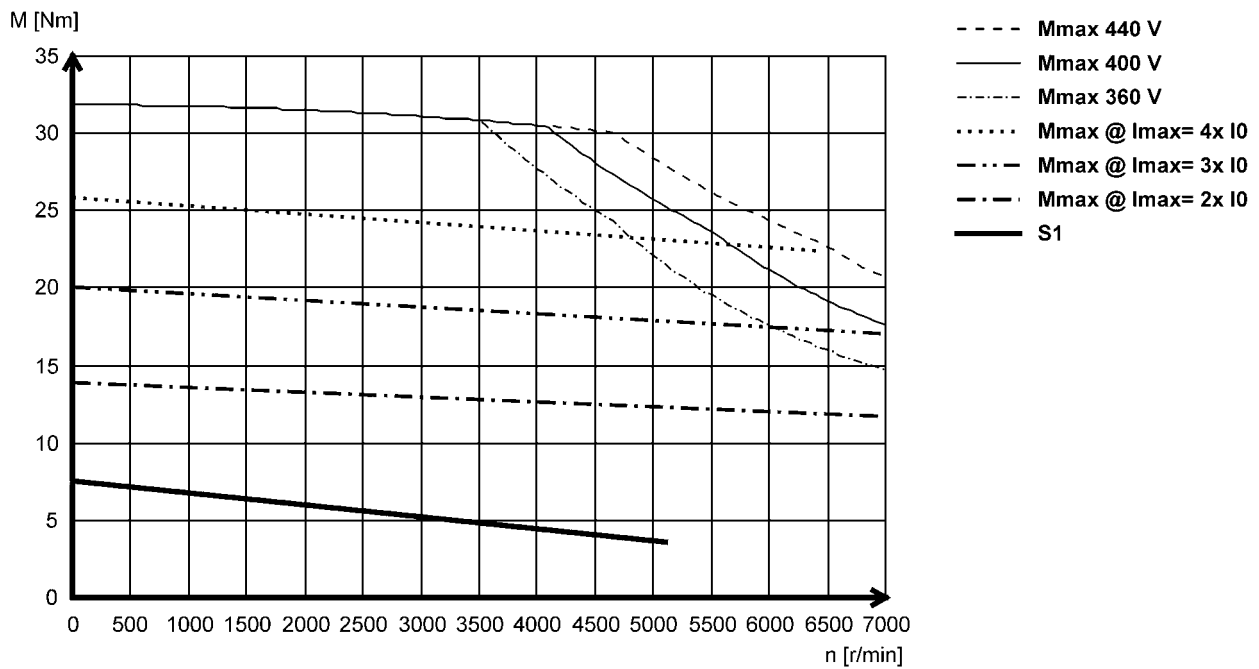

MCS synchronous servo motors

Technical data



Torque characteristics

► The data applies to a mains connection voltage of 3 x 400 V.

MCS12D17 (forced ventilated)

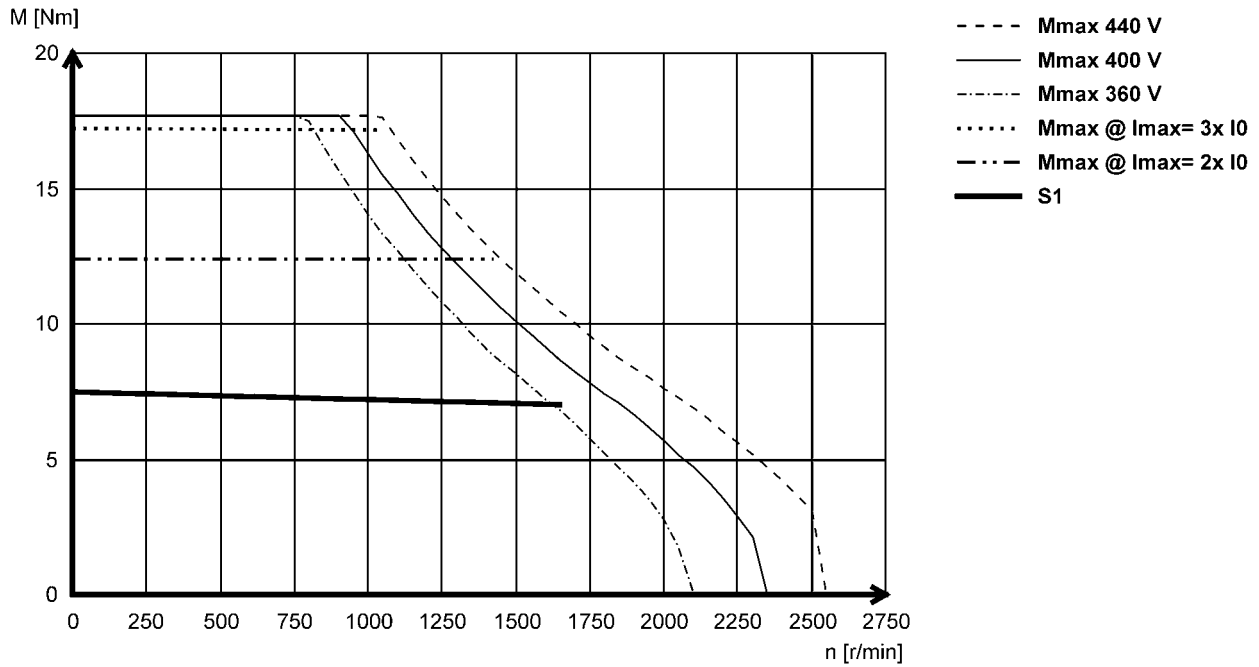

5.1

MCS12D20- (non-ventilated)

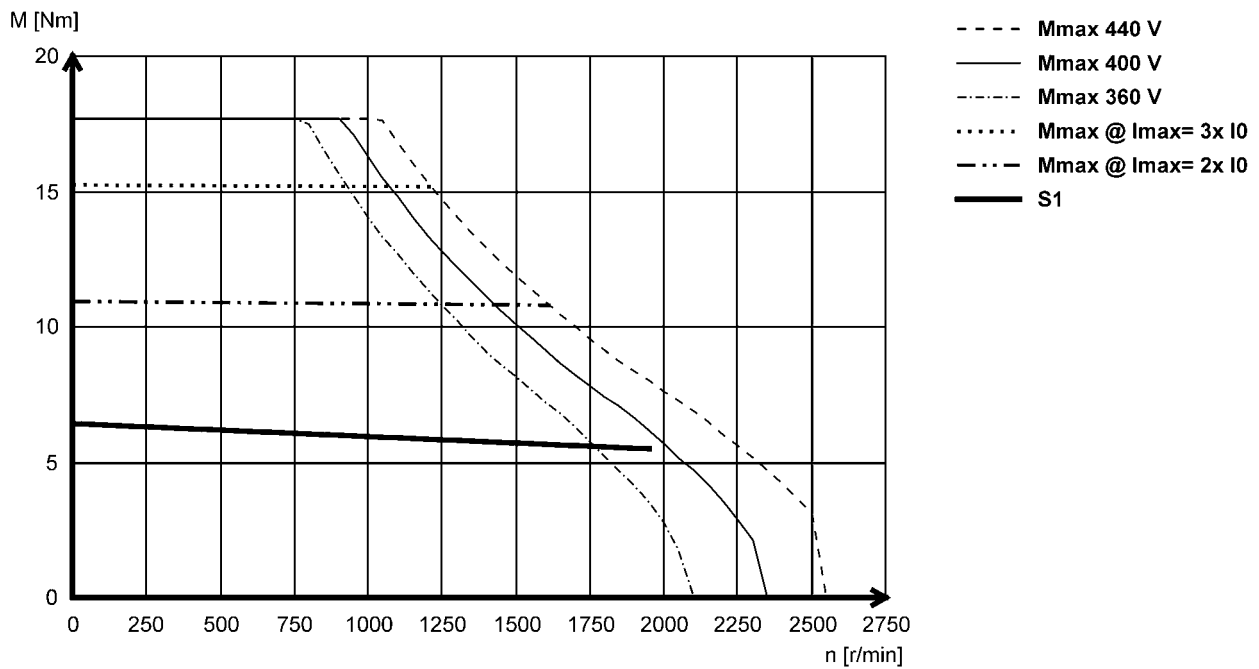

MCS synchronous servo motors

Technical data



Torque characteristics

► The data applies to a mains connection voltage of 3 x 400 V.

MCS12D35- (forced ventilated)

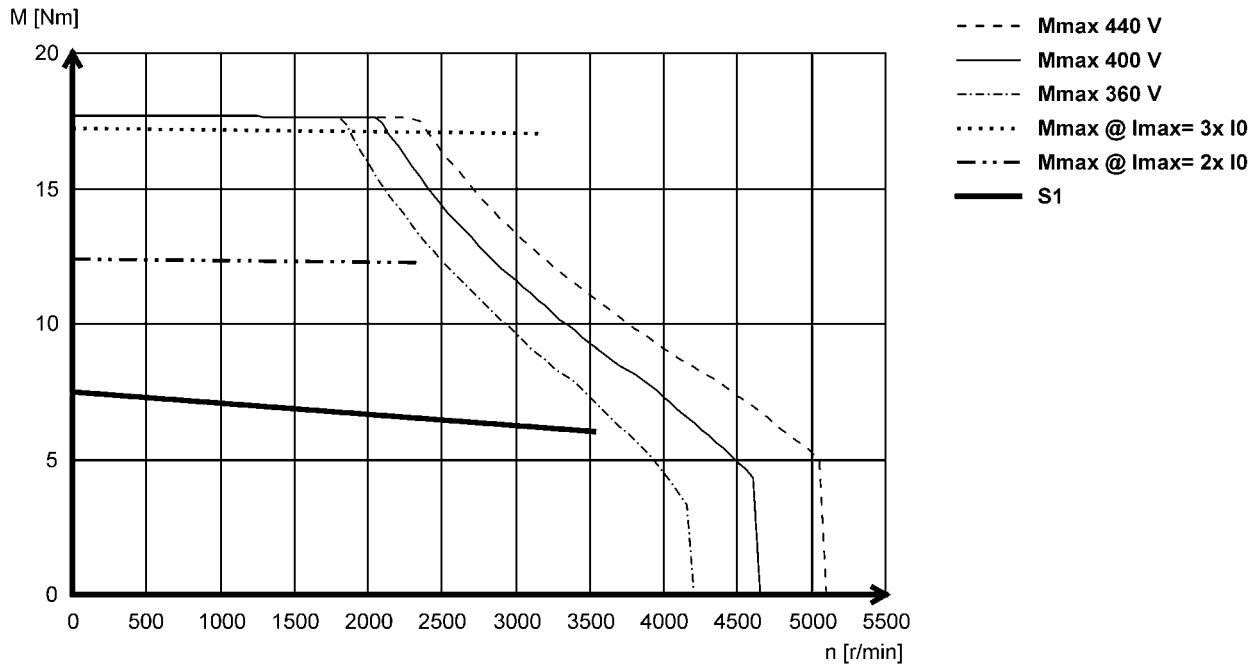

5.1

MCS12D41- (non-ventilated)

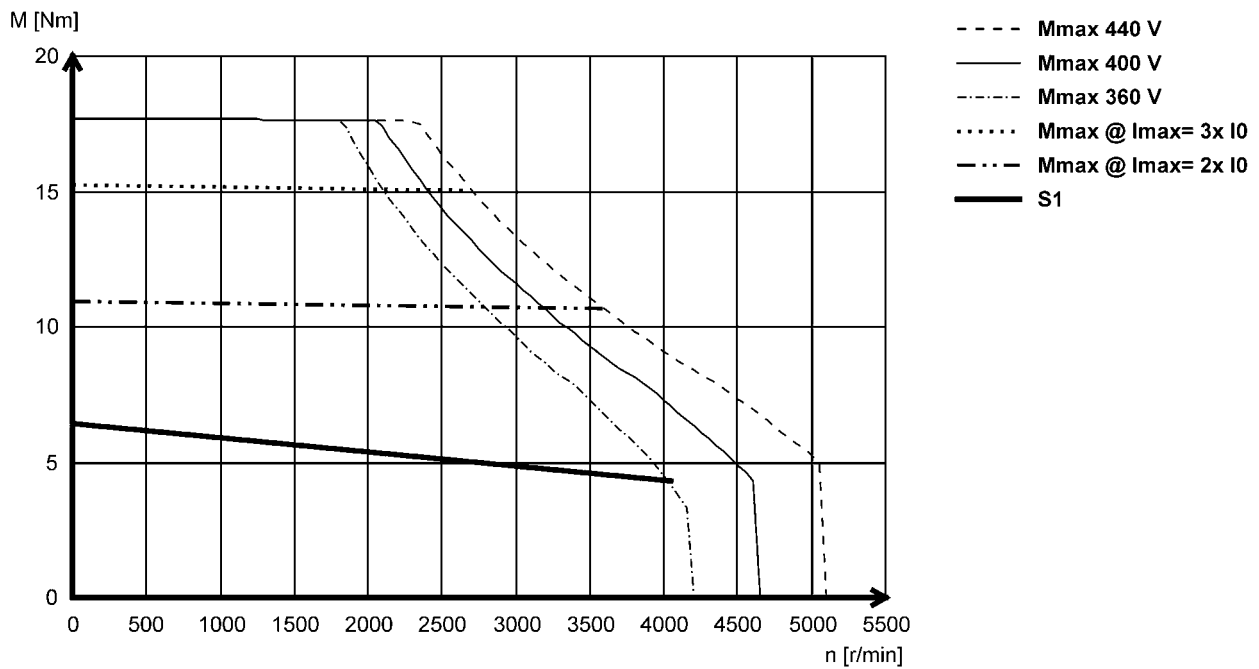

MCS synchronous servo motors

Technical data



Torque characteristics

► The data applies to a mains connection voltage of 3 x 400 V.

MCS12H14- (forced ventilated)

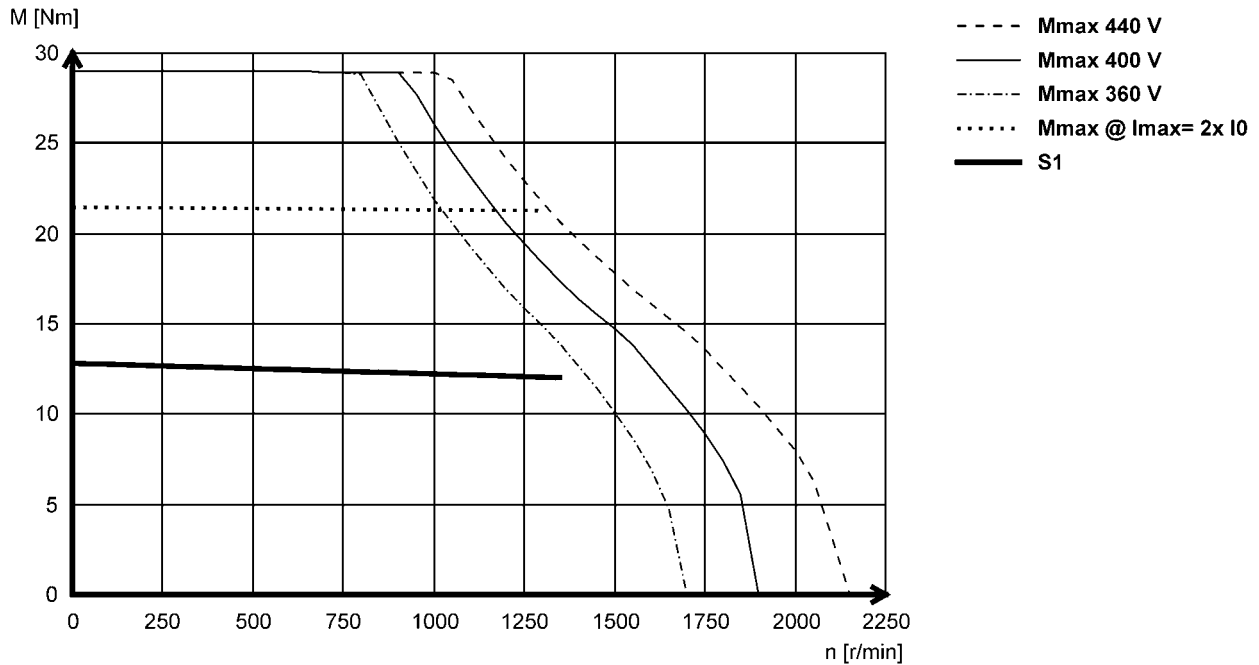

5.1

MCS12H15- (non-ventilated)

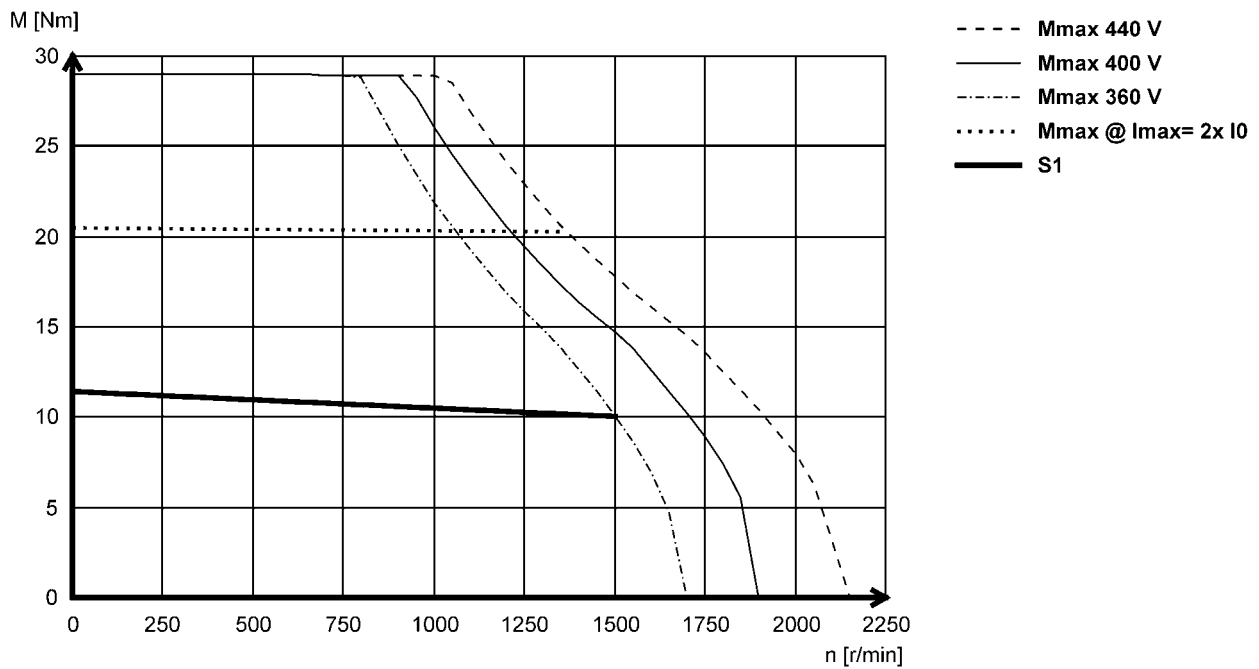

MCS synchronous servo motors

Technical data



Torque characteristics

► The data applies to a mains connection voltage of 3 x 400 V.

MCS12H34- (forced ventilated)

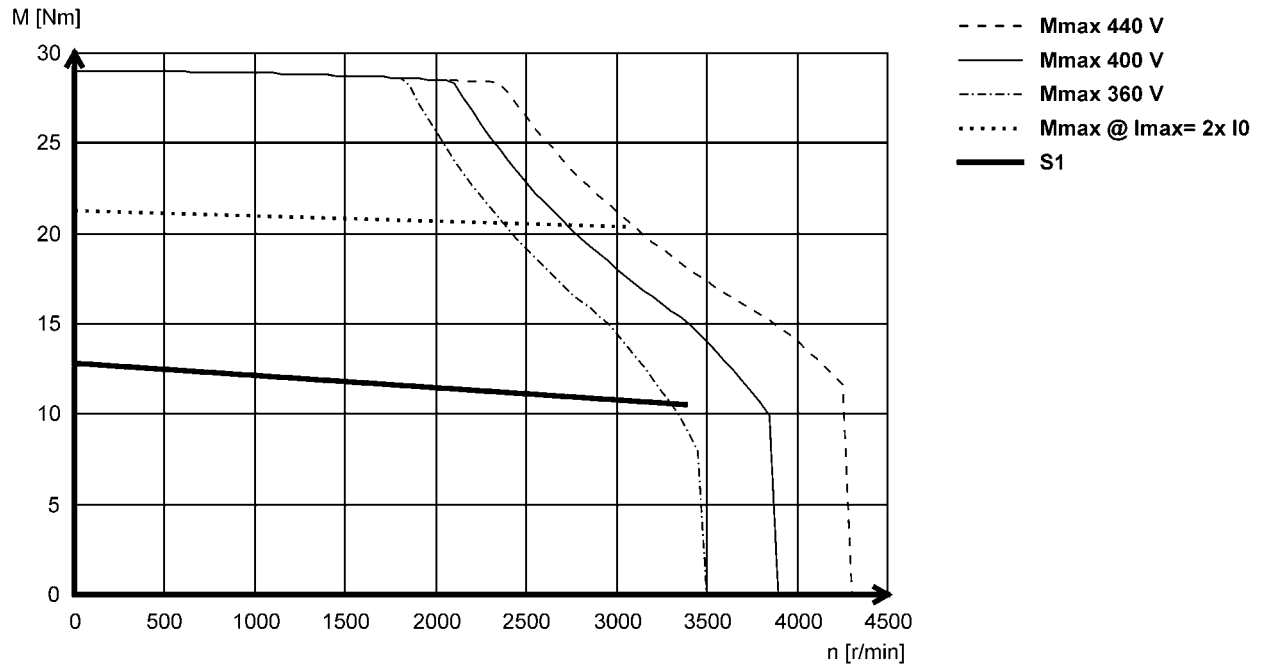

5.1

MCS12H35- (non-ventilated)

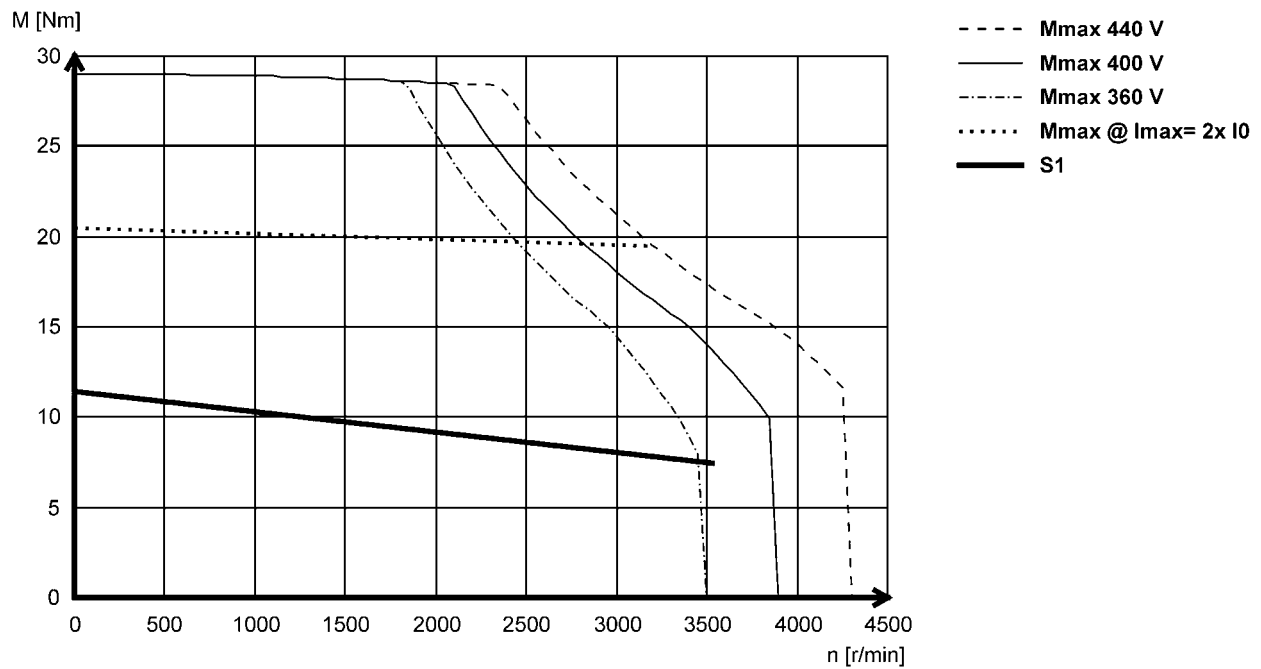

MCS synchronous servo motors

Technical data



Torque characteristics

► The data applies to a mains connection voltage of 3 x 400 V.

MCS12L17- (forced ventilated)

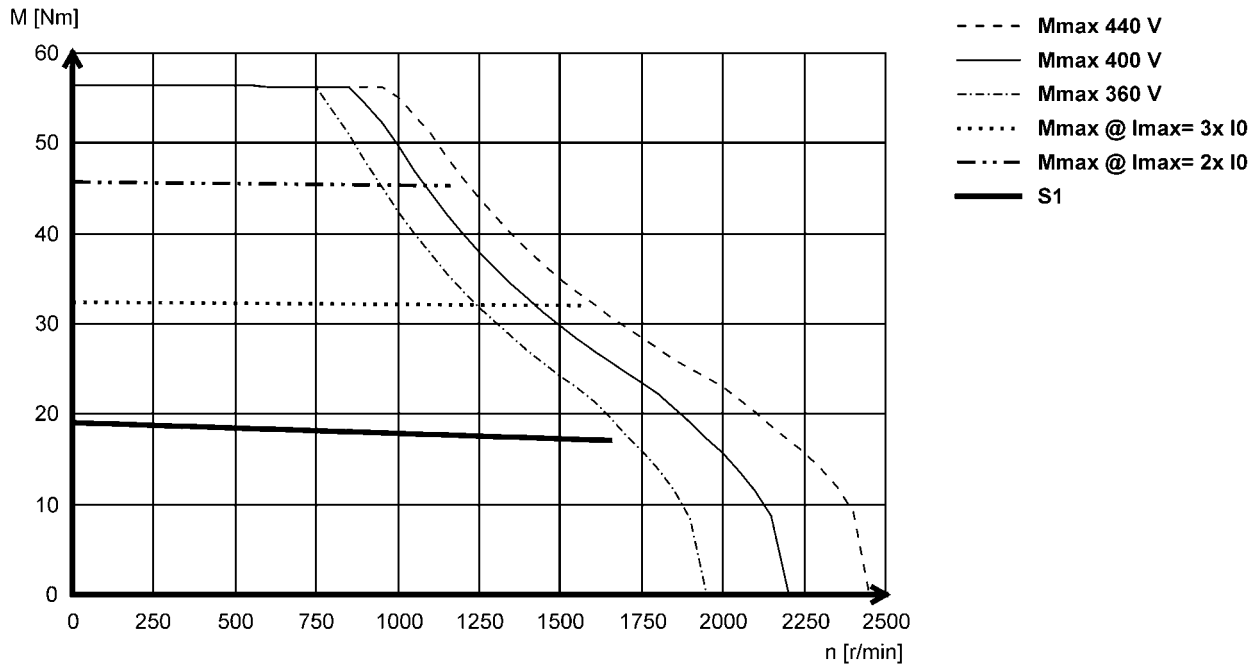

5.1

MCS12L20- (non-ventilated)

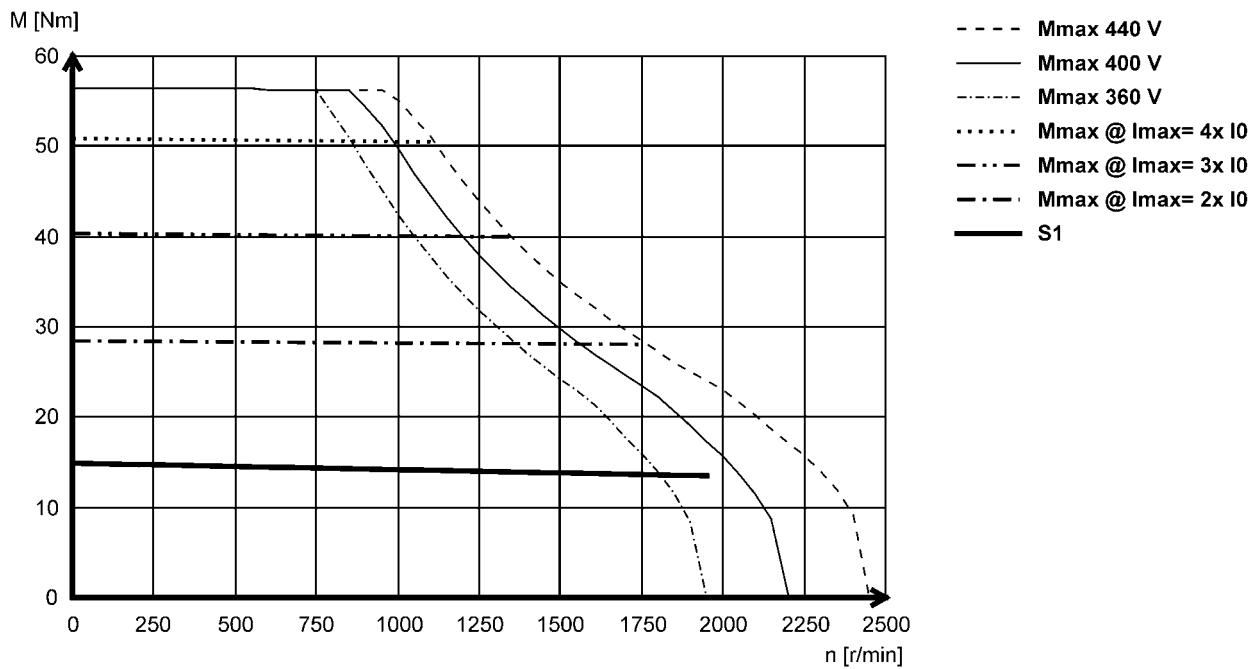

MCS synchronous servo motors

Technical data



Torque characteristics

► The data applies to a mains connection voltage of 3 x 400 V.

MCS12L39- (forced ventilated)

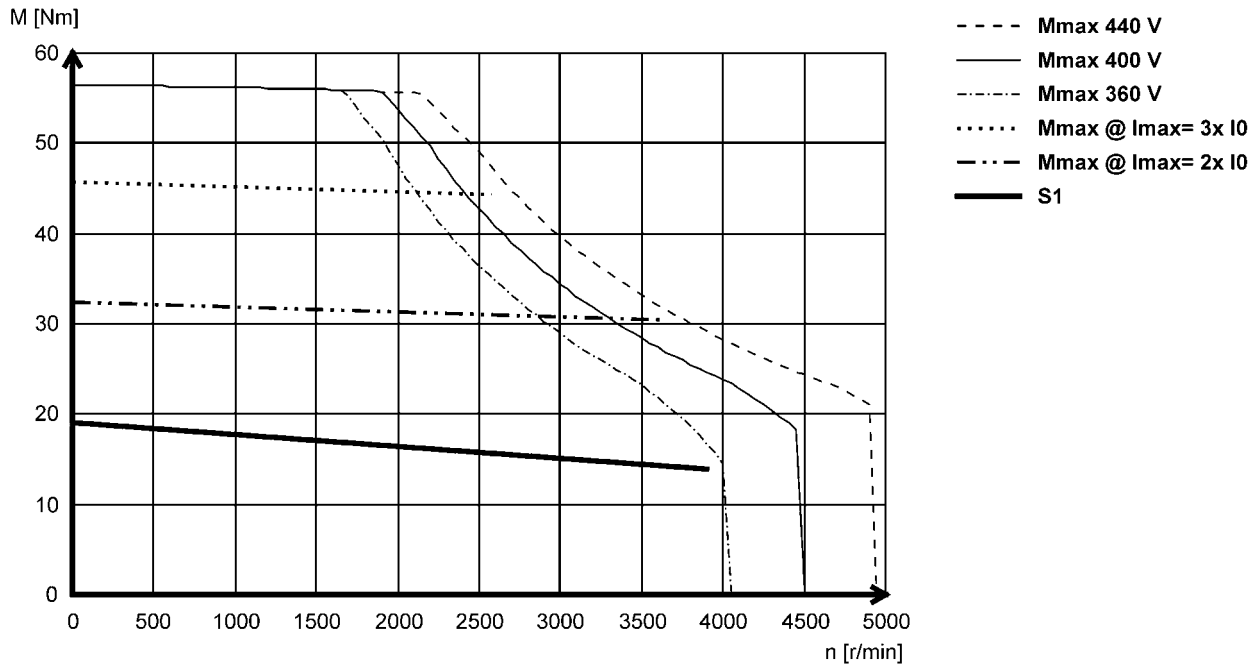

5.1

MCS12L41- (non-ventilated)

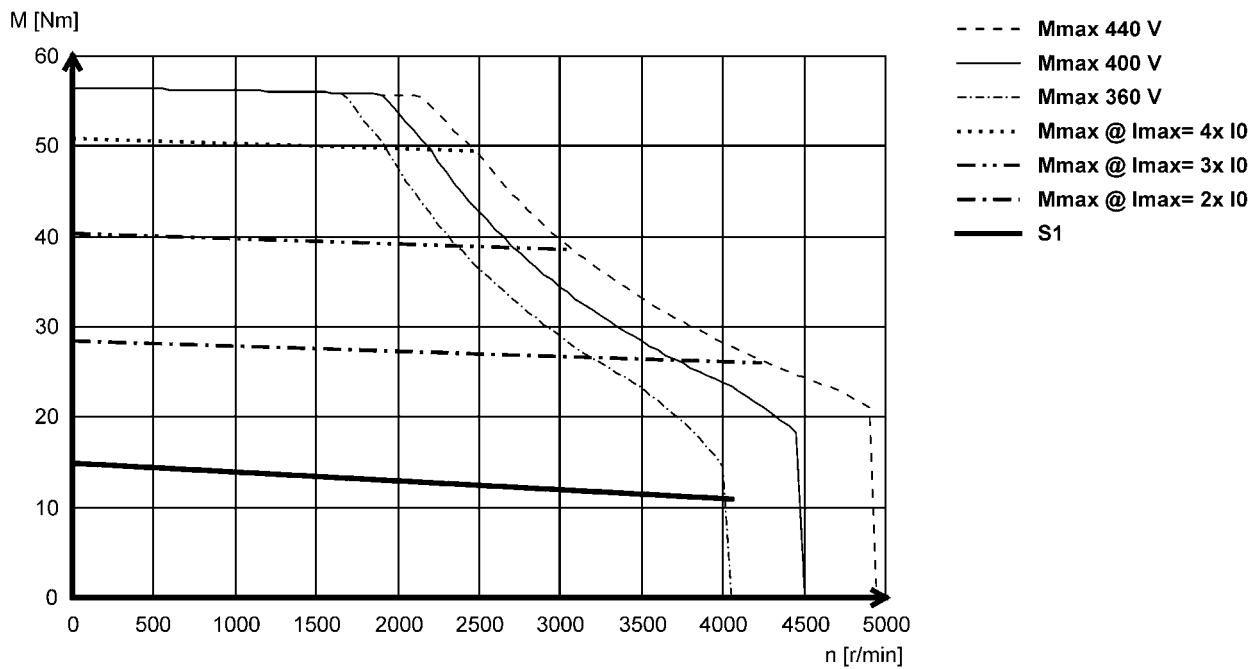

MCS synchronous servo motors

Technical data



Torque characteristics

► The data applies to a mains connection voltage of 3 x 400 V.

MCS14D14- (forced ventilated)

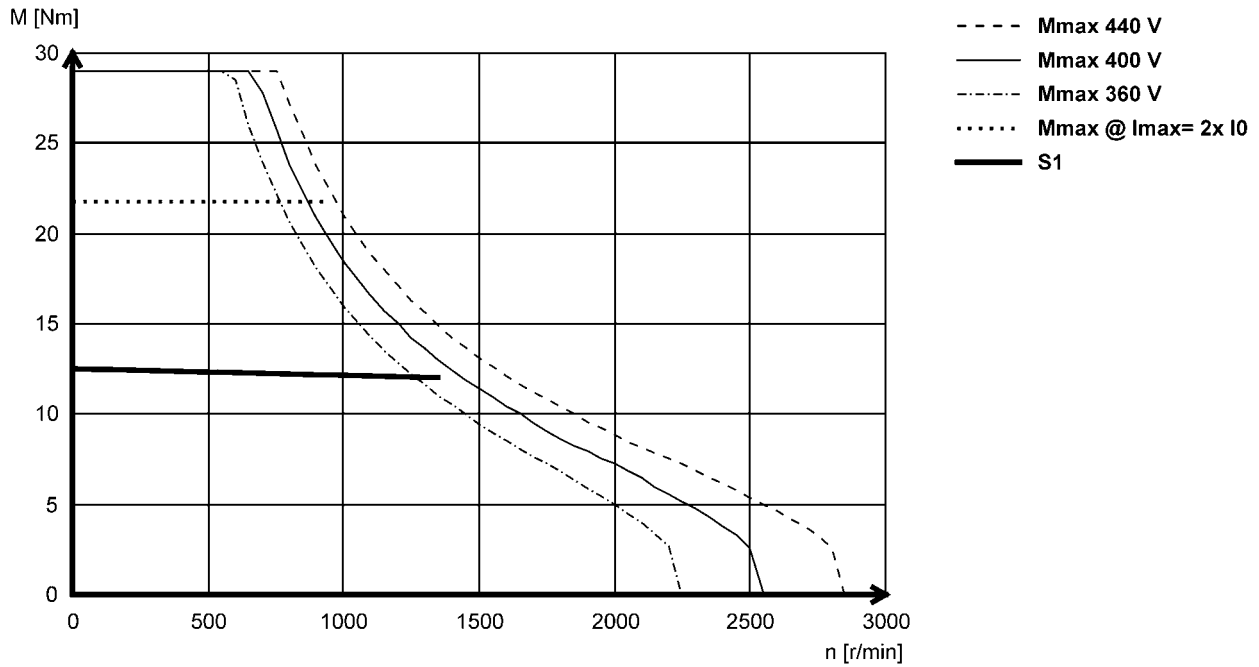

5.1

MCS14D15- (non-ventilated)

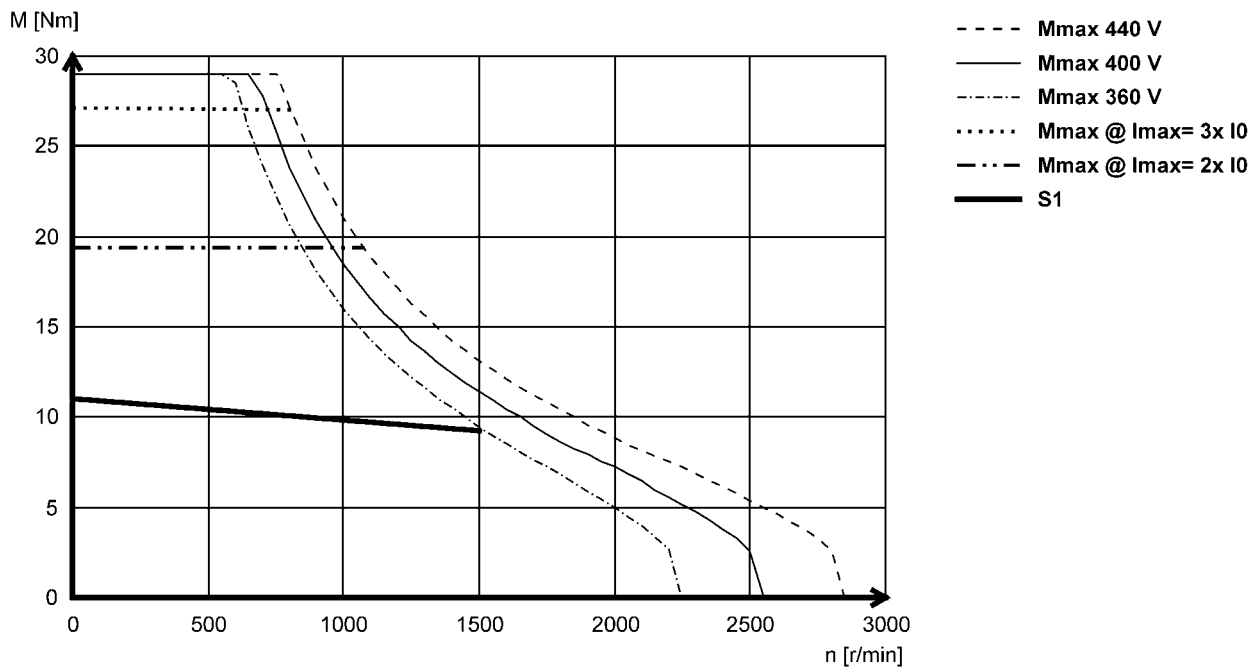

MCS synchronous servo motors

Technical data



Torque characteristics

► The data applies to a mains connection voltage of 3 x 400 V.

MCS14D30 (forced ventilated)

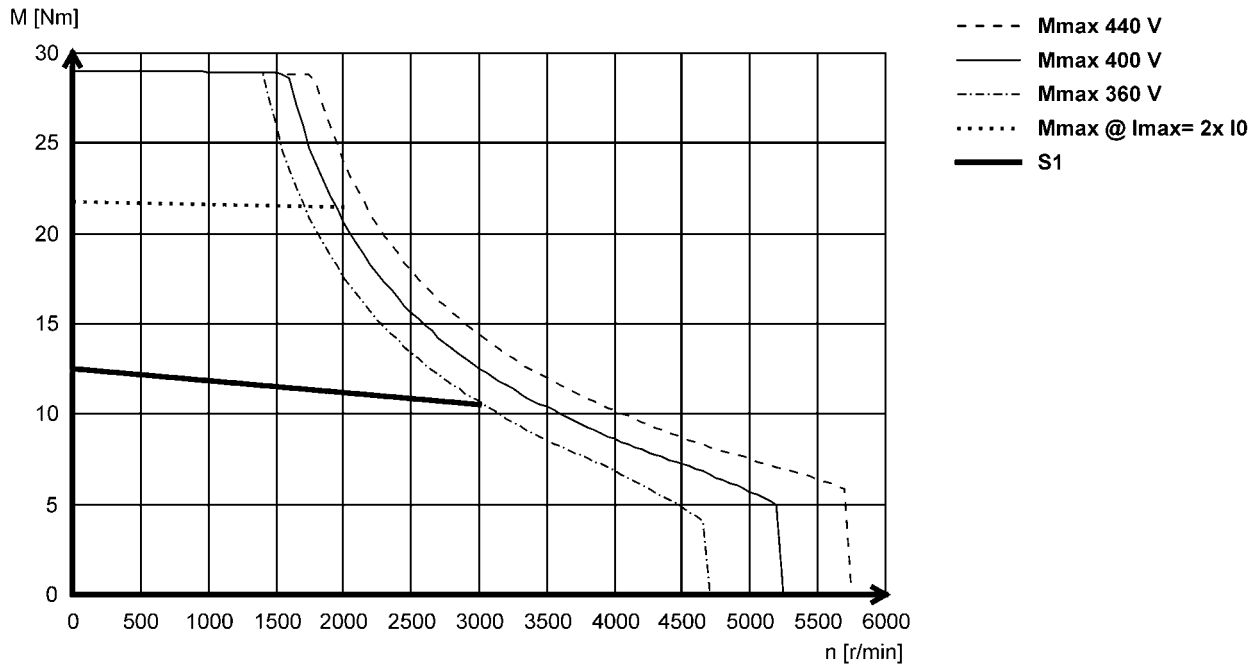

5.1

MCS14D36- (non-ventilated)

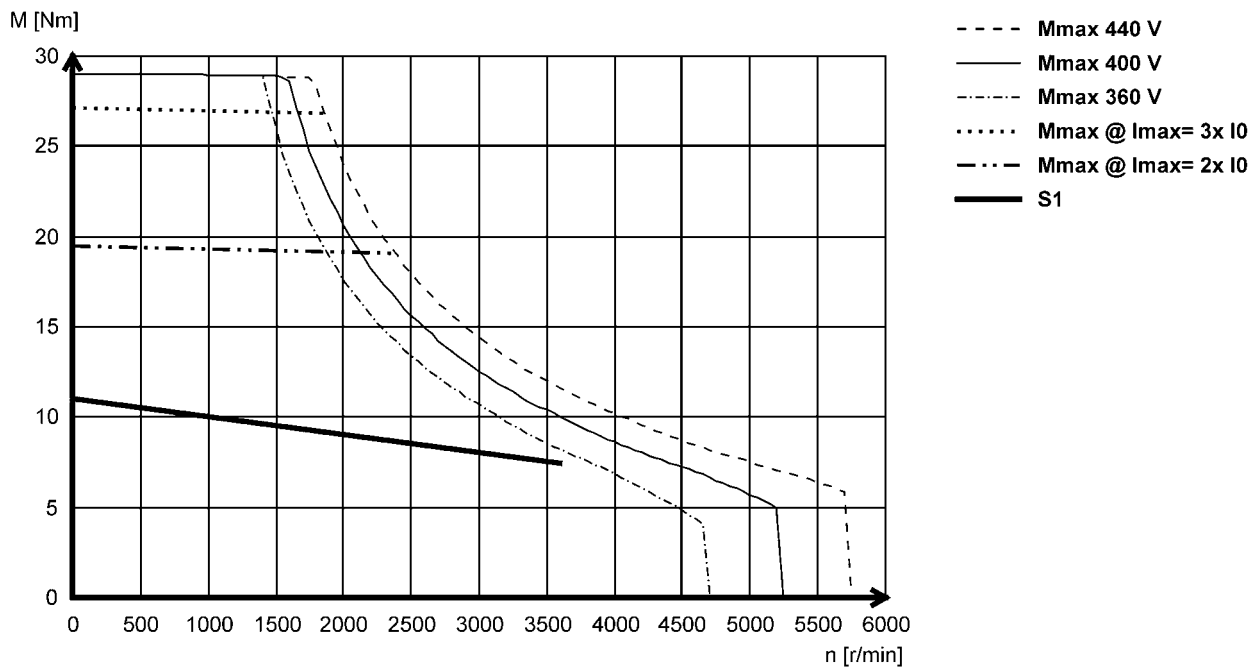

MCS synchronous servo motors

Technical data



Torque characteristics

► The data applies to a mains connection voltage of 3 x 400 V.

MCS14H12- (forced ventilated)

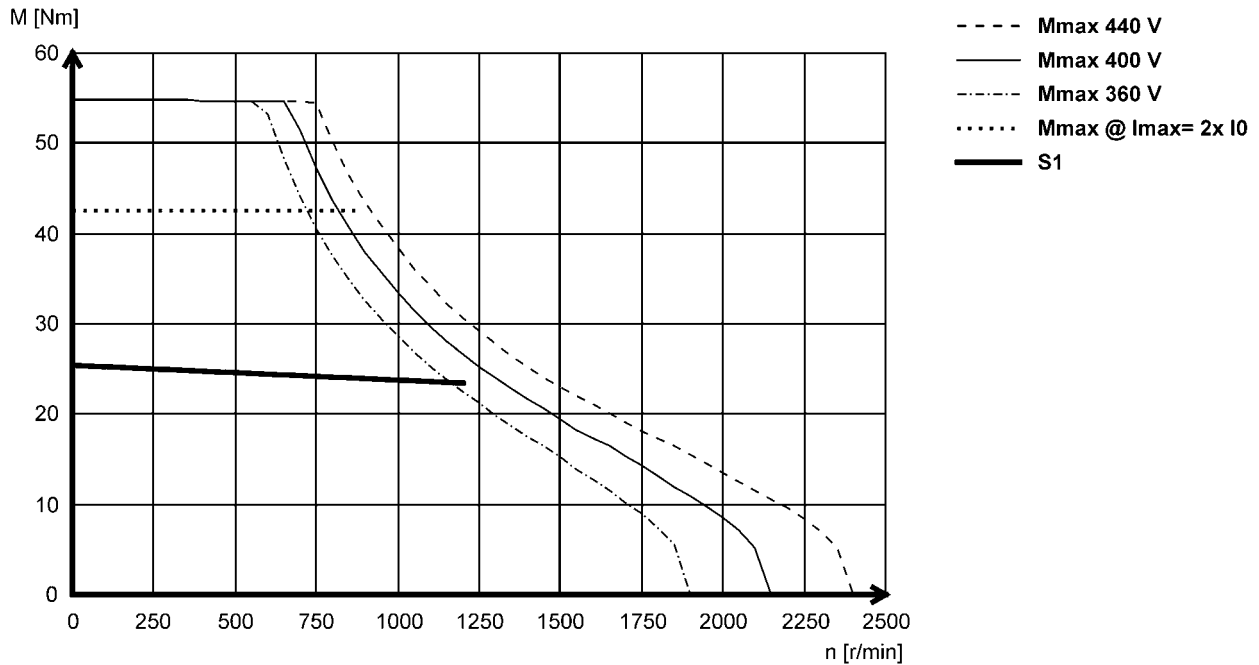

5.1

MCS14H15- (non-ventilated)

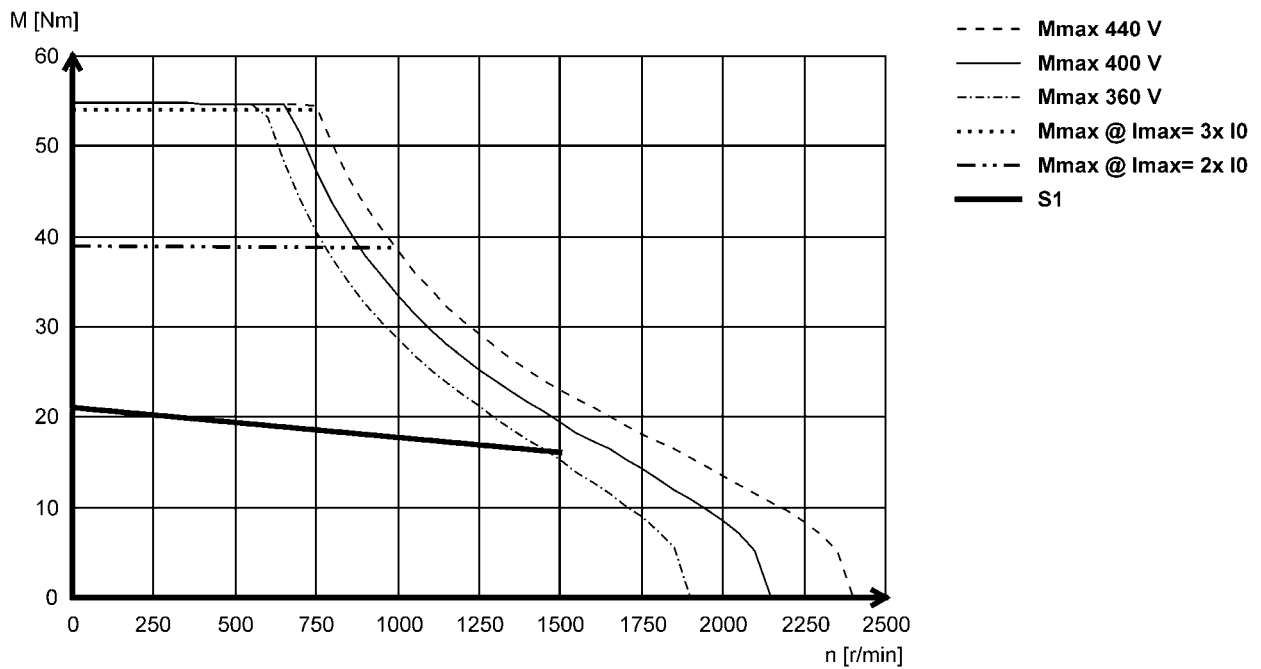

MCS synchronous servo motors

Technical data



Torque characteristics

► The data applies to a mains connection voltage of 3 x 400 V.

MCS14H28- (forced ventilated)

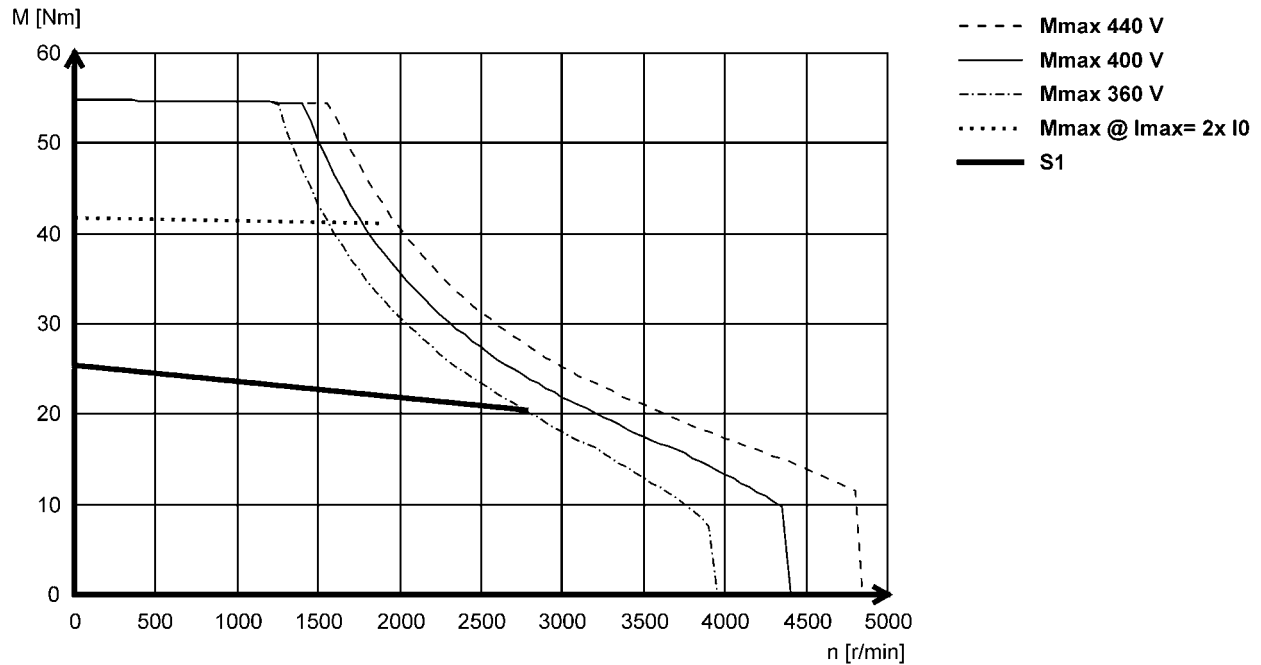

5.1

MCS14H32- (non-ventilated)

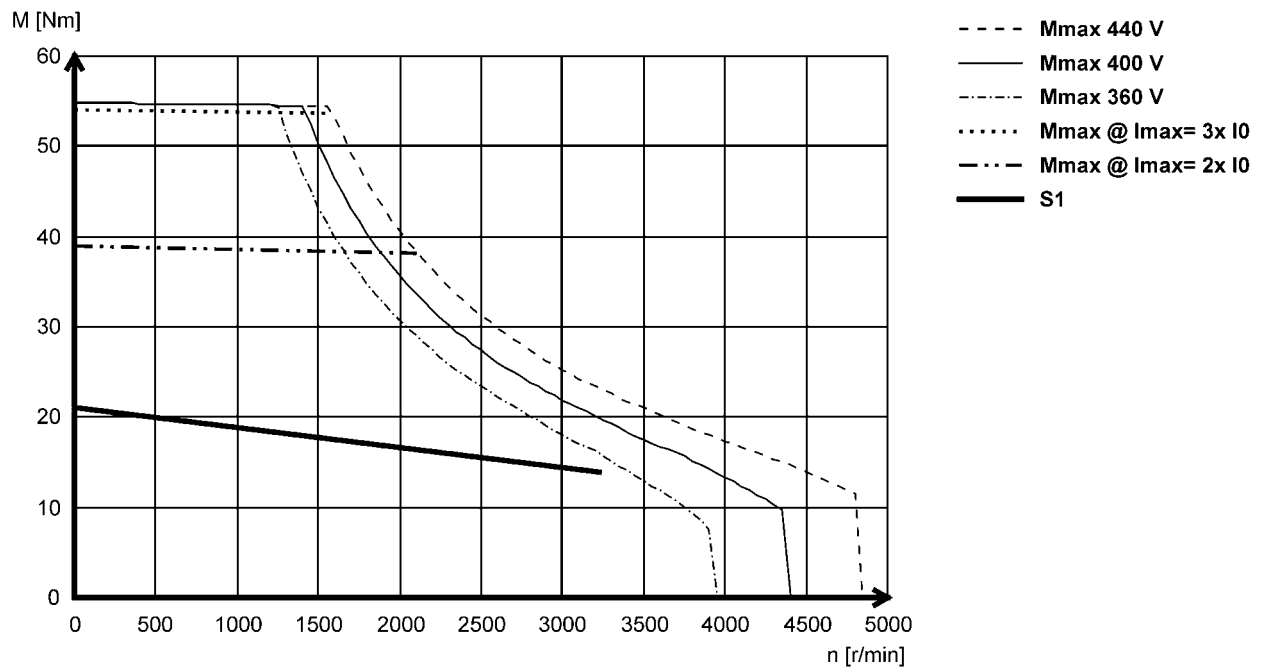

MCS synchronous servo motors

Technical data



Torque characteristics

► The data applies to a mains connection voltage of 3 x 400 V.

MCS14L14- (forced ventilated)

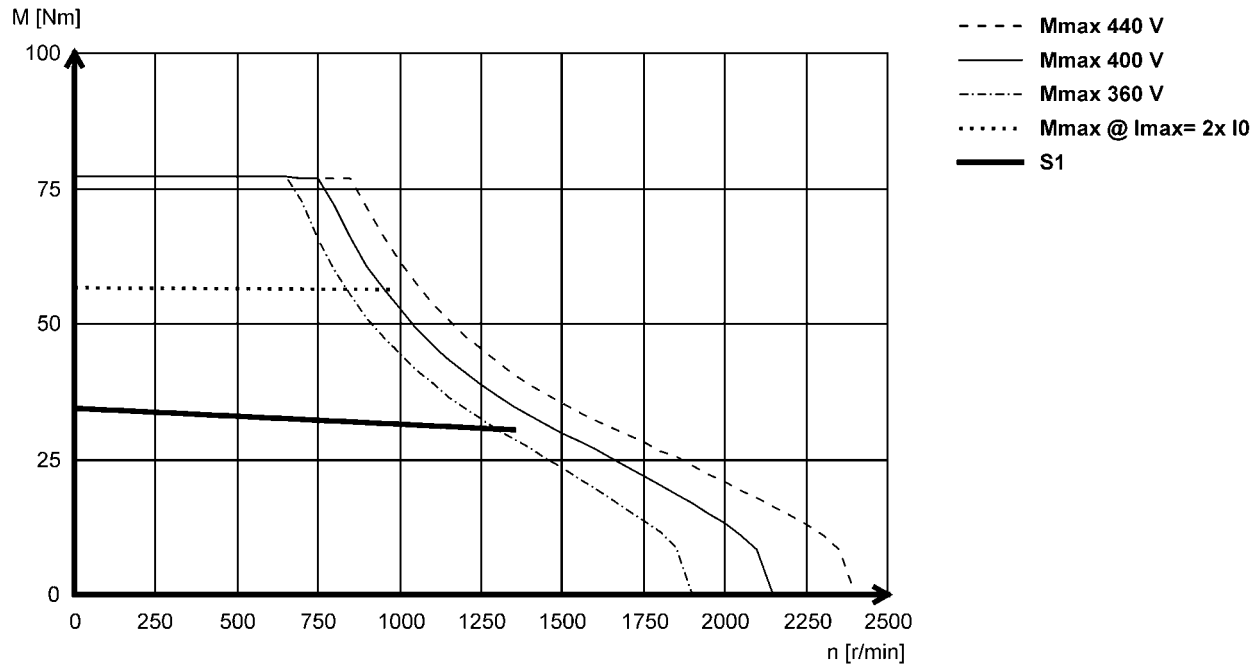

5.1

MCS14L15- (non-ventilated)

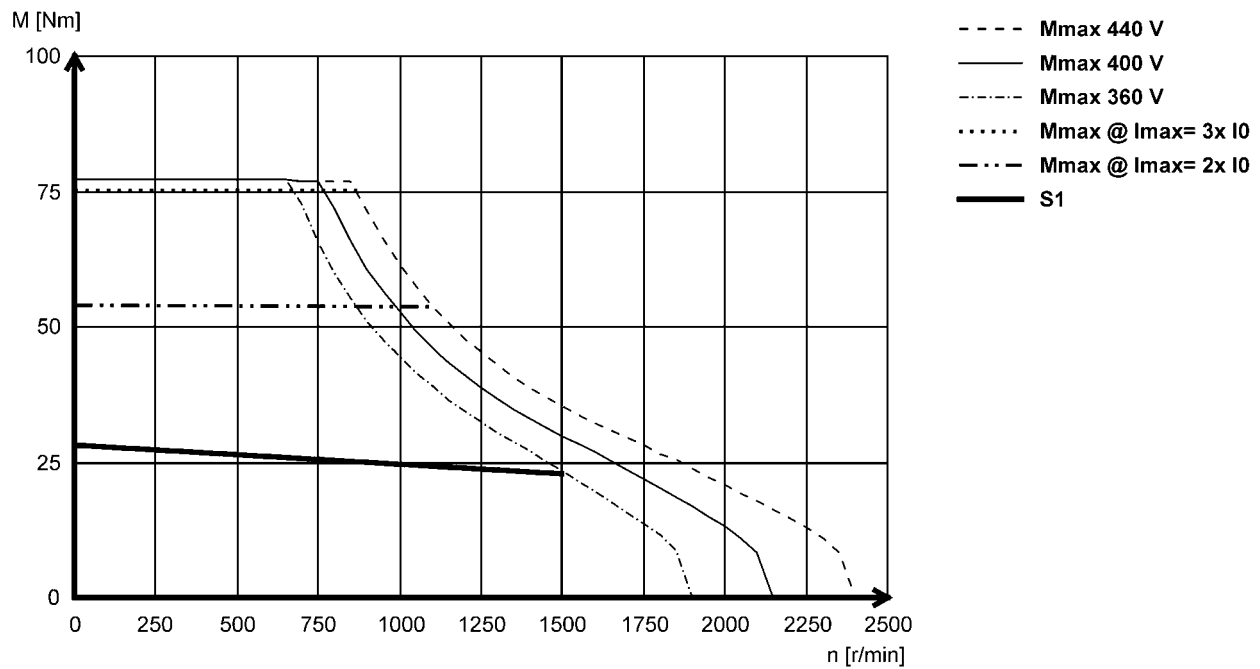

MCS synchronous servo motors

Technical data



Torque characteristics

► The data applies to a mains connection voltage of 3 x 400 V.

MCS14L30- (forced ventilated)

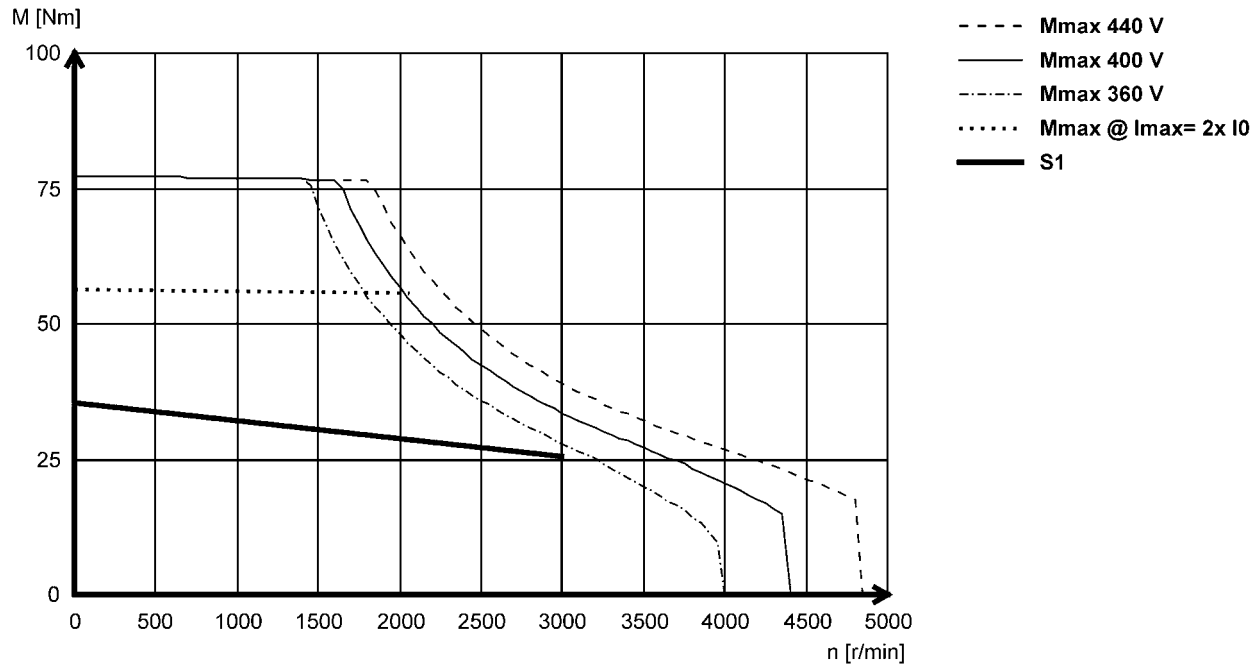

5.1

MCS14L32- (non-ventilated)

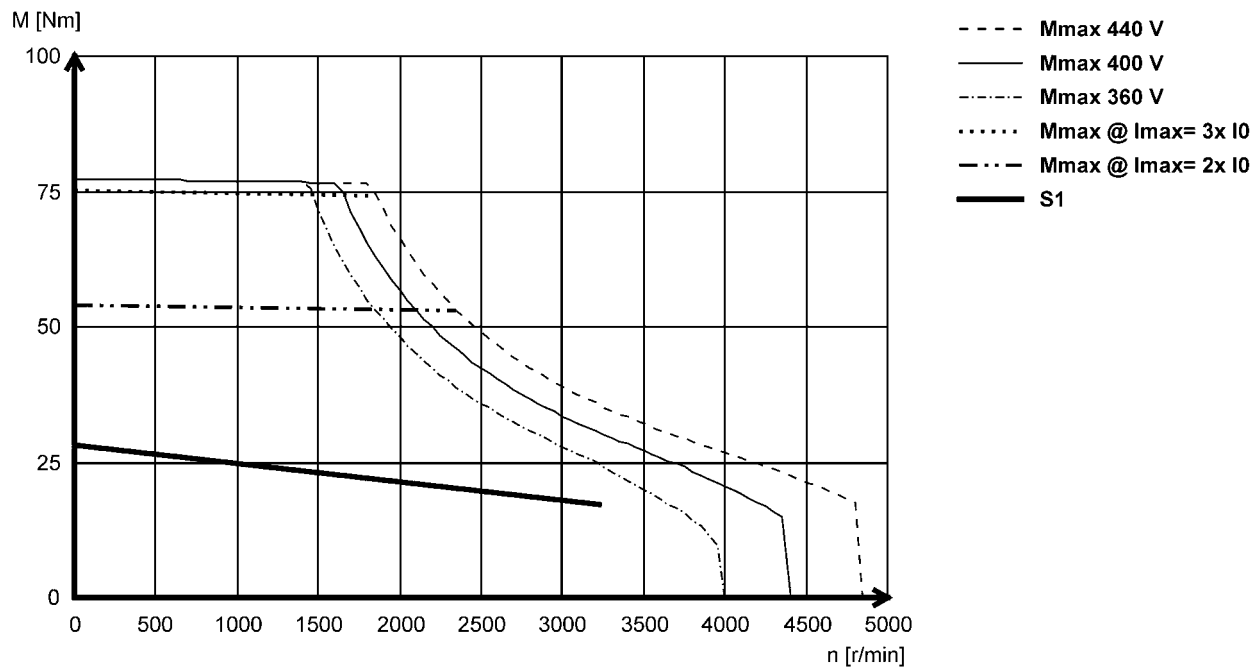

MCS synchronous servo motors

Technical data



Torque characteristics

► The data applies to a mains connection voltage of 3 x 400 V.

MCS14P11- (forced ventilated)

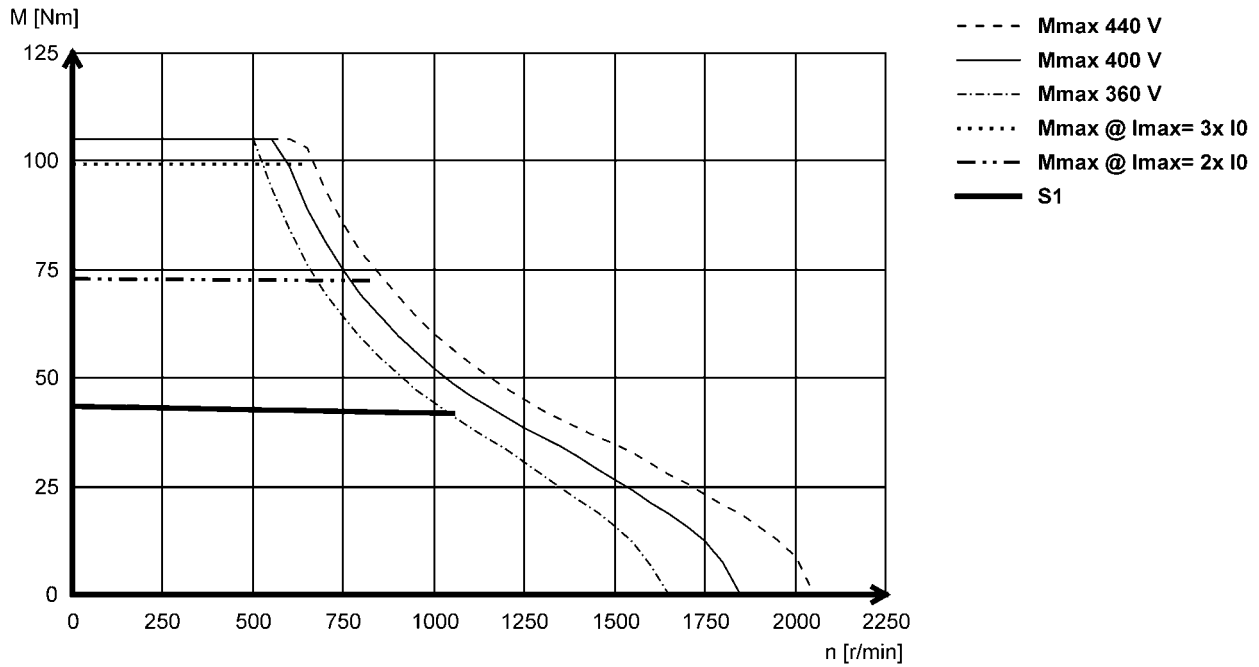

5.1

MCS14P14- (non-ventilated)

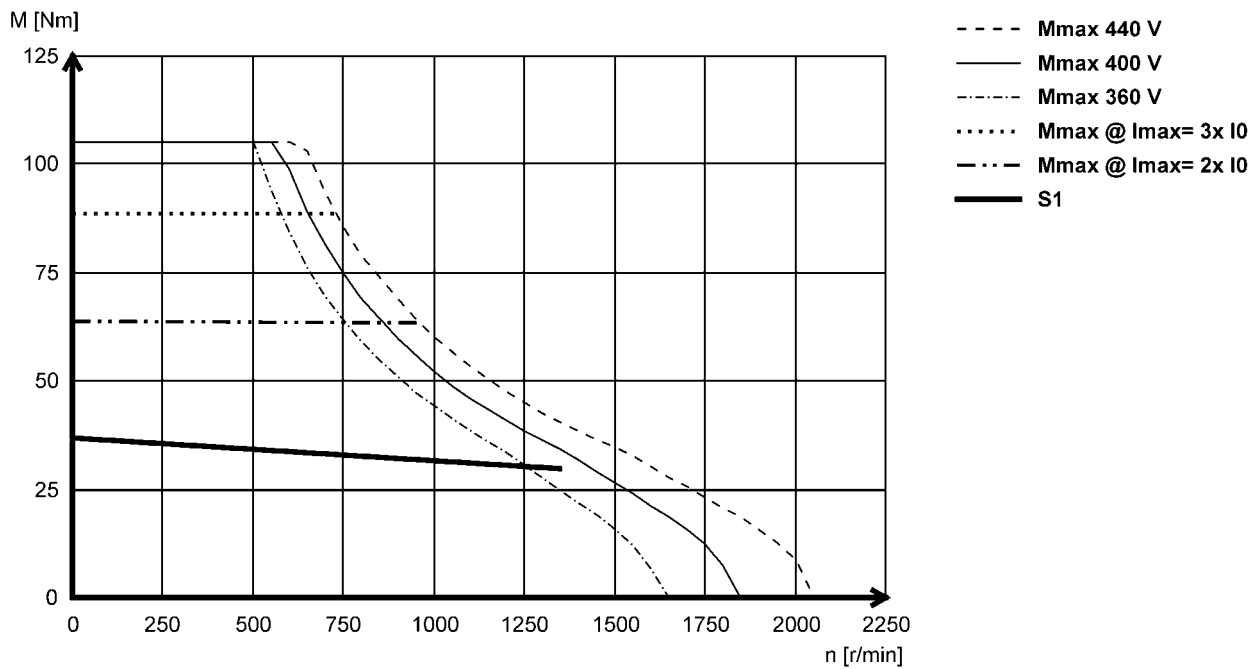

MCS synchronous servo motors

Technical data



Torque characteristics

► The data applies to a mains connection voltage of 3 x 400 V.

MCS14P26- (forced ventilated)

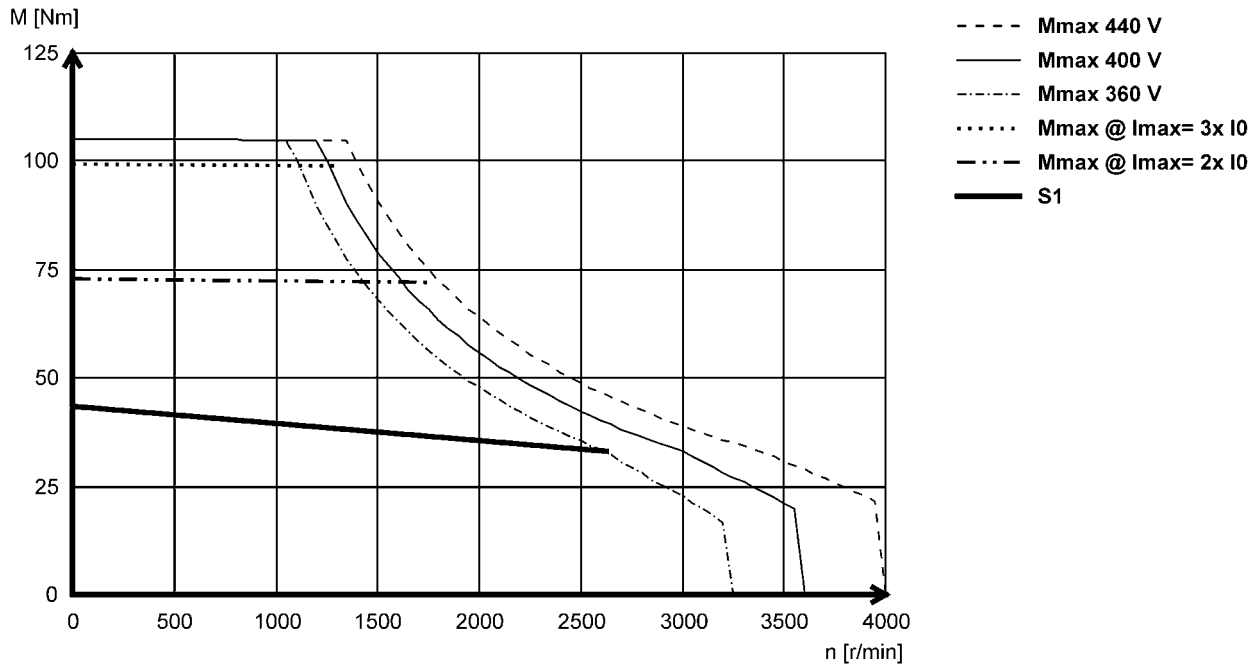

5.1

MCS14P32- (non-ventilated)

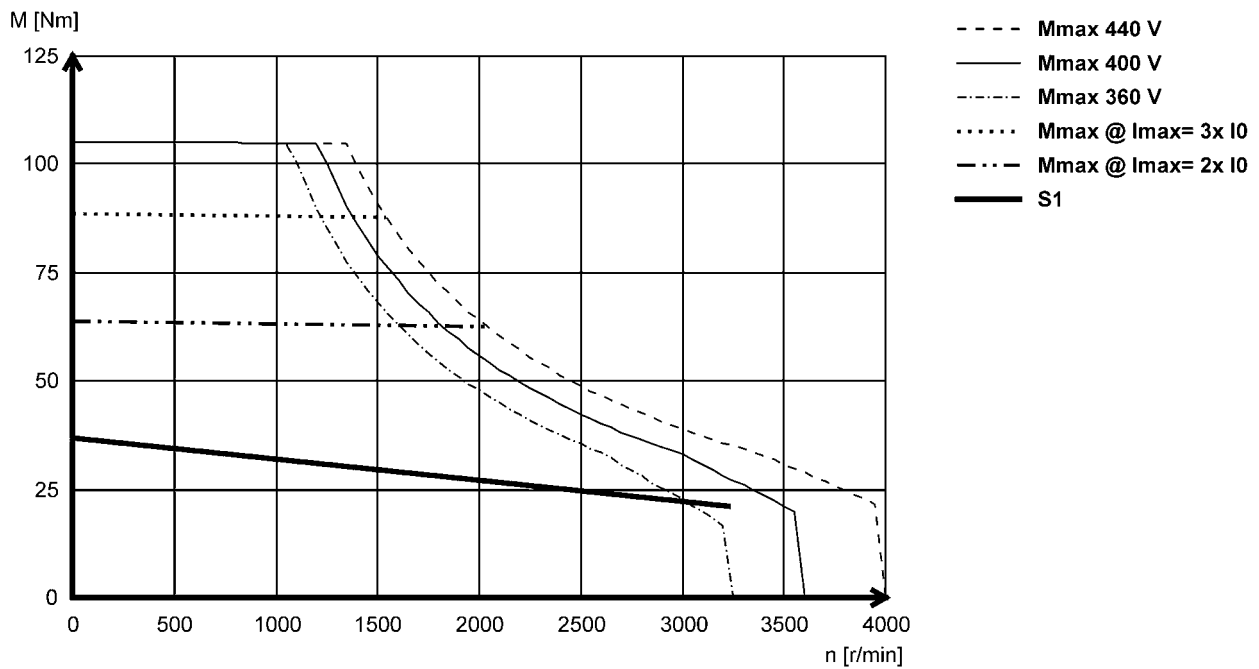

MCS synchronous servo motors

Technical data



Torque characteristics

► The data applies to a mains connection voltage of 3 x 400 V.

MCS19F12- (forced ventilated)

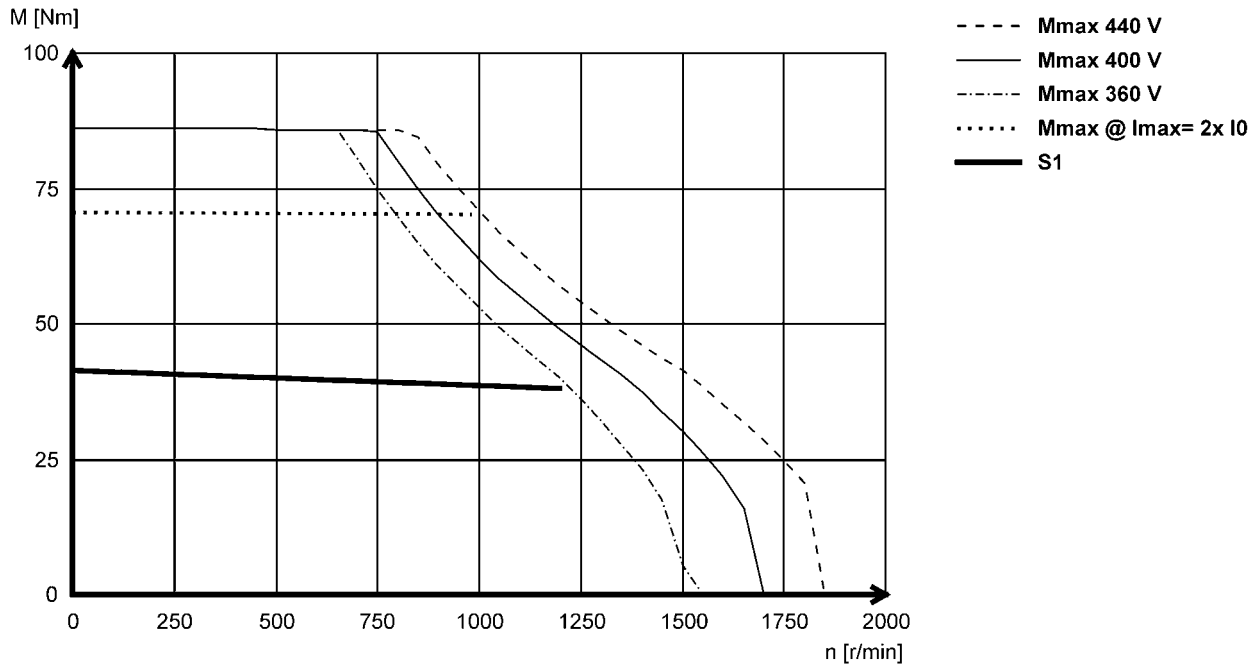

5.1

MCS19F14- (non-ventilated)

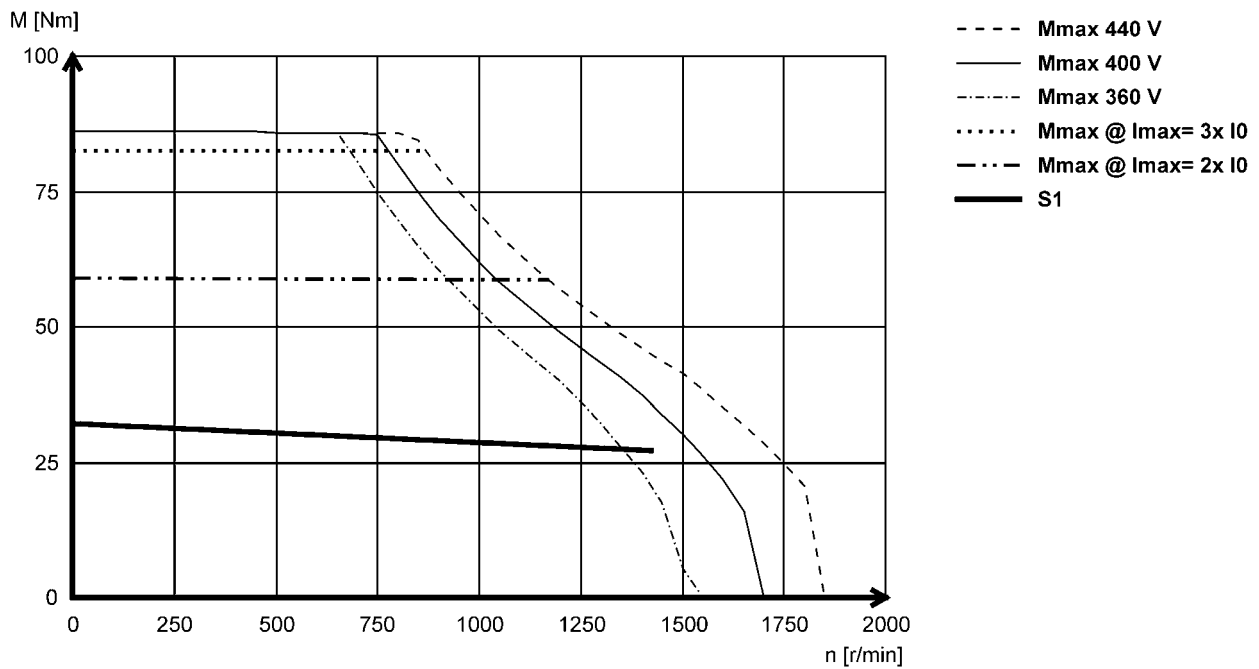

MCS synchronous servo motors

Technical data



Torque characteristics

► The data applies to a mains connection voltage of 3 x 400 V.

MCS19F29- (forced ventilated)

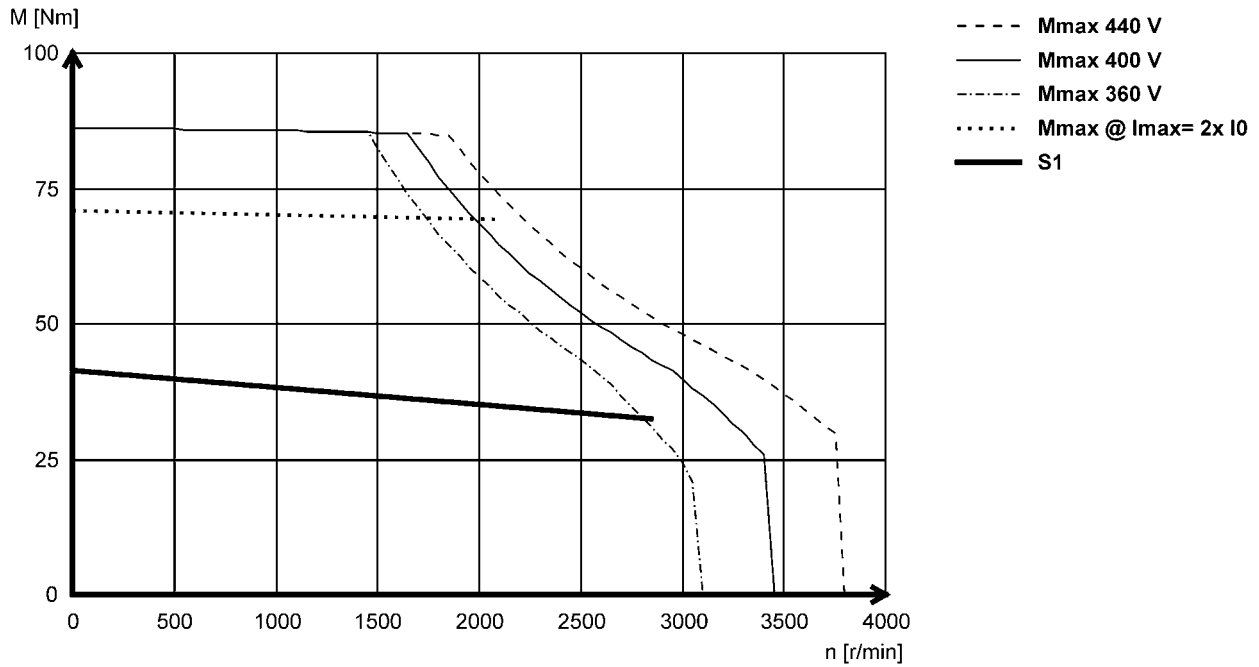

5.1

MCS19F30- (non-ventilated)

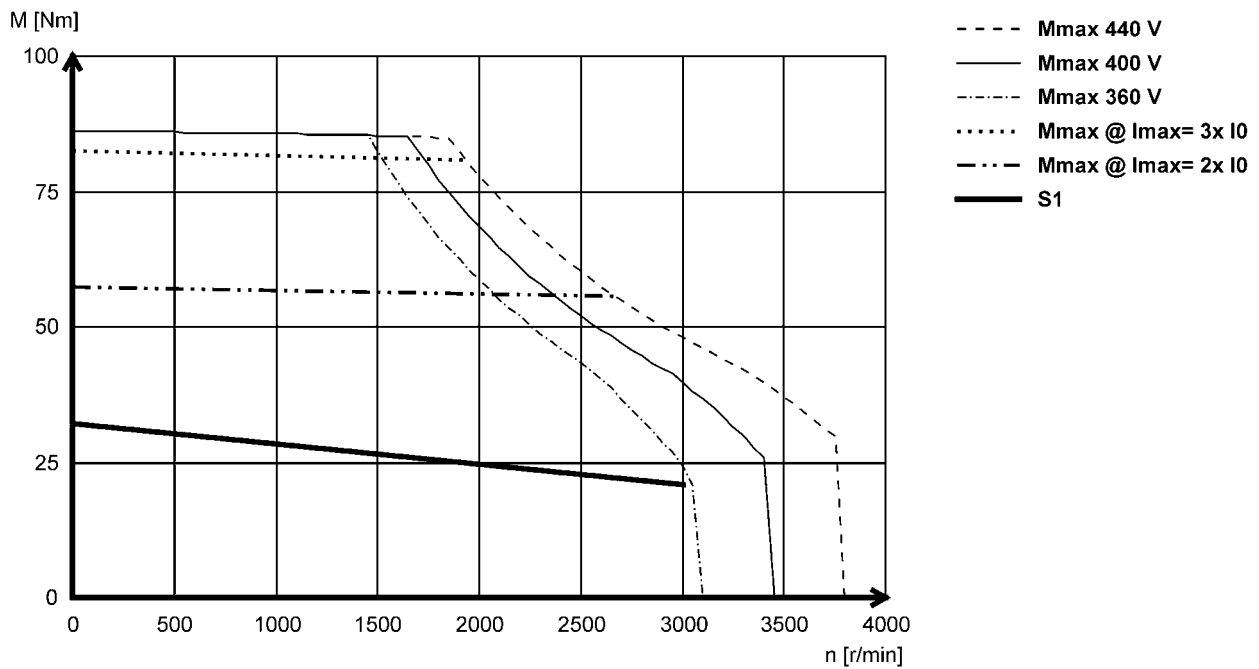

MCS synchronous servo motors

Technical data



Torque characteristics

► The data applies to a mains connection voltage of 3 x 400 V.

MCS19J12- (forced ventilated)

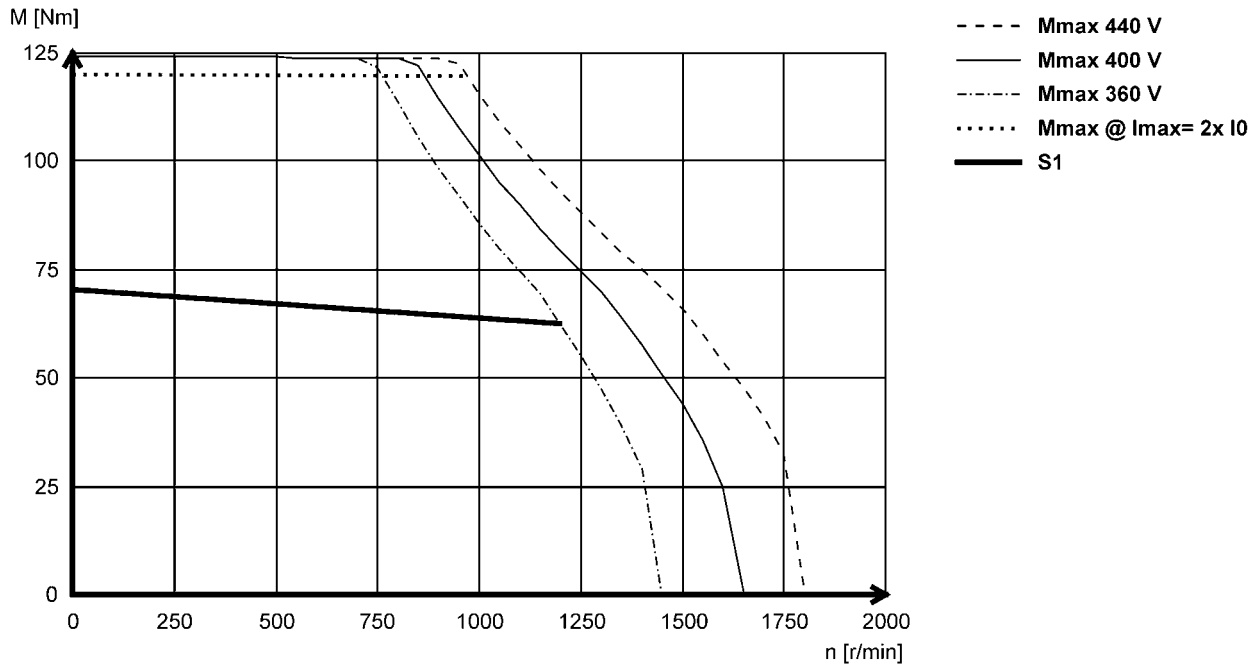

5.1

MCS19J14- (non-ventilated)

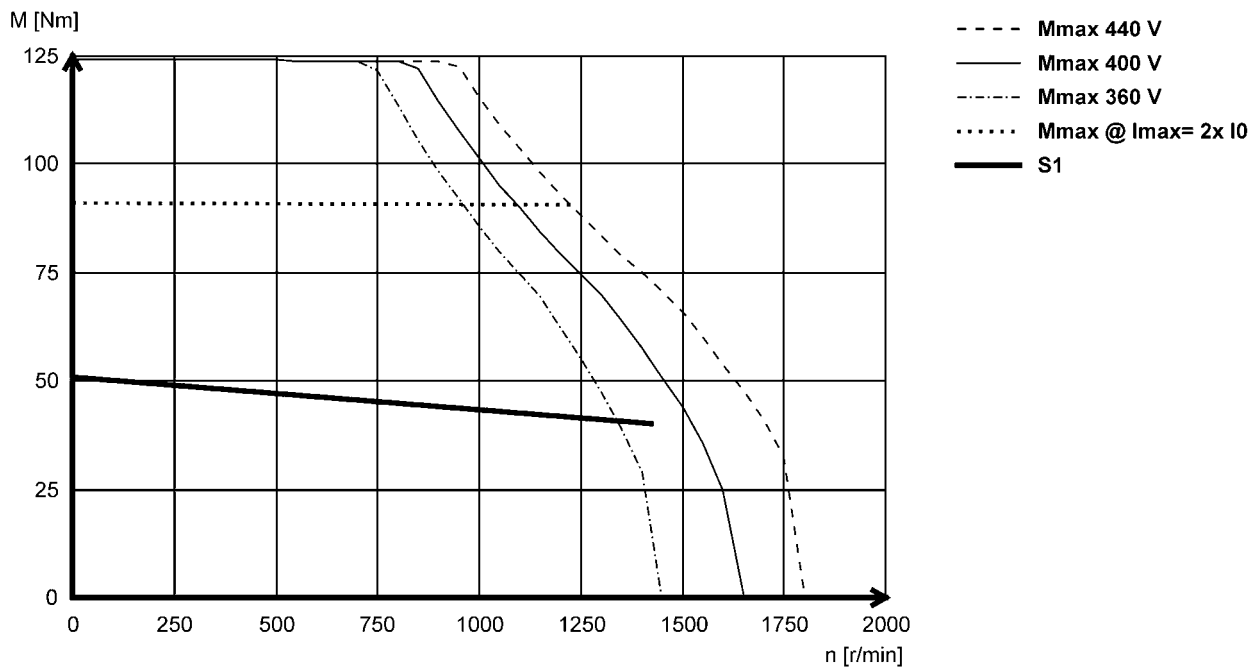

MCS synchronous servo motors

Technical data



Torque characteristics

► The data applies to a mains connection voltage of 3 x 400 V.

MCS19J29- (forced ventilated)

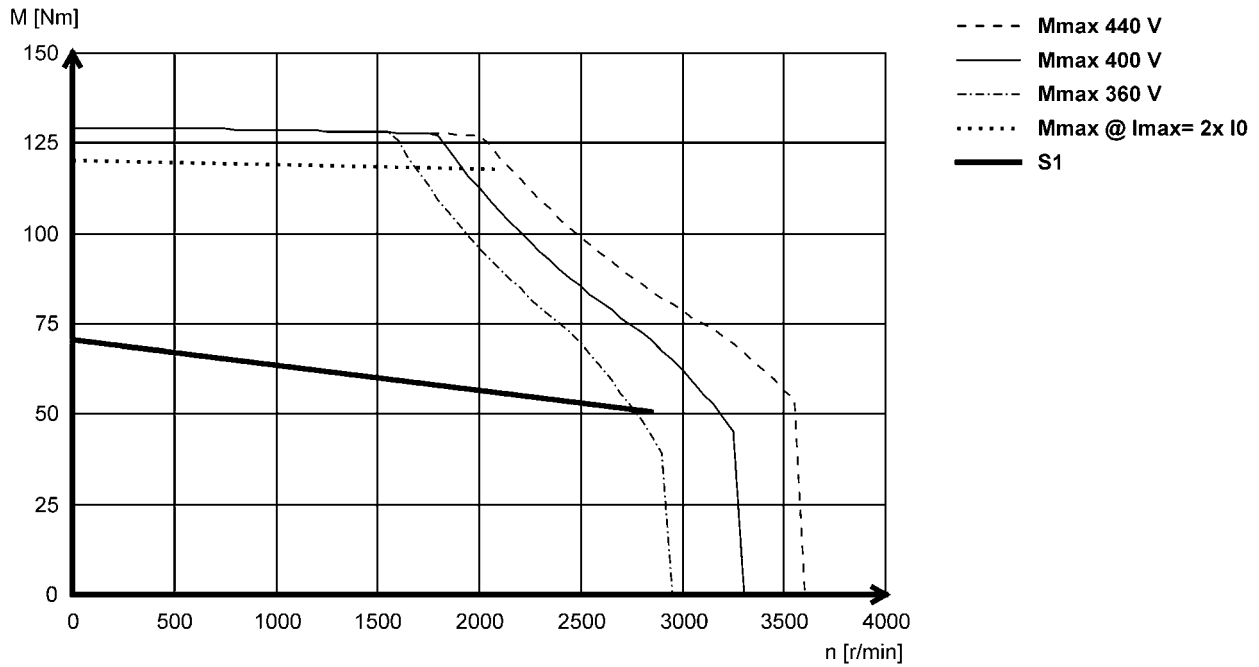

5.1

MCS19J30- (non-ventilated)

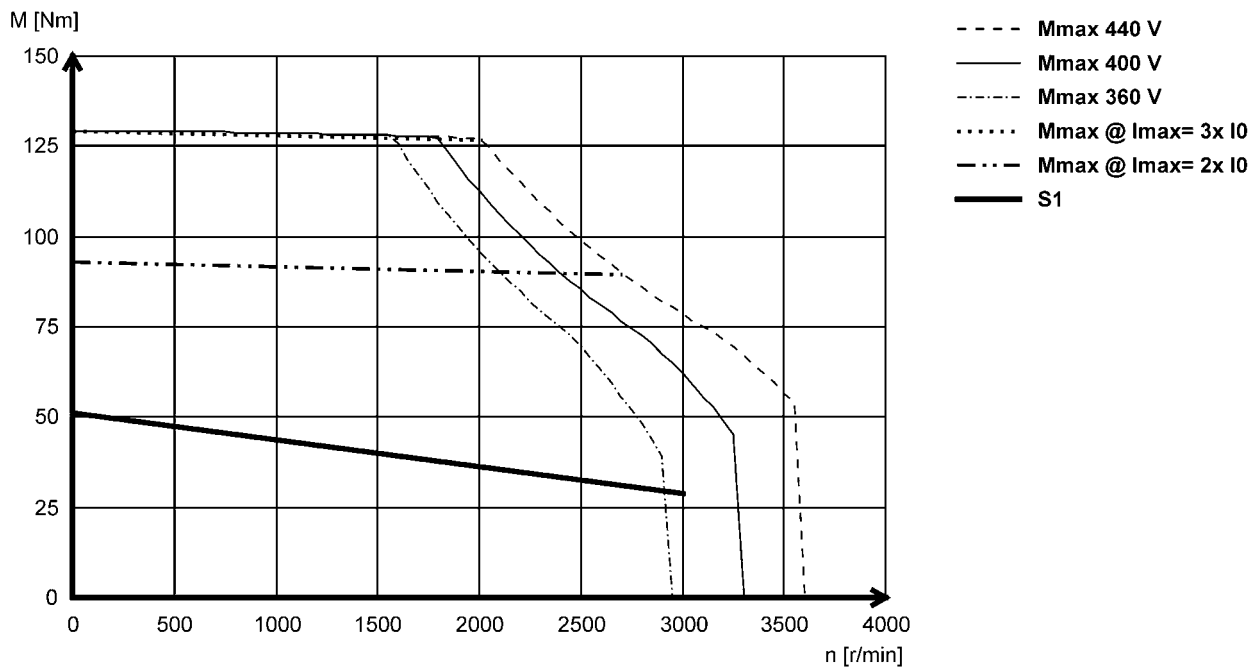

MCS synchronous servo motors

Technical data



Torque characteristics

► The data applies to a mains connection voltage of 3 x 400 V.

MCS19P12 (forced ventilated)

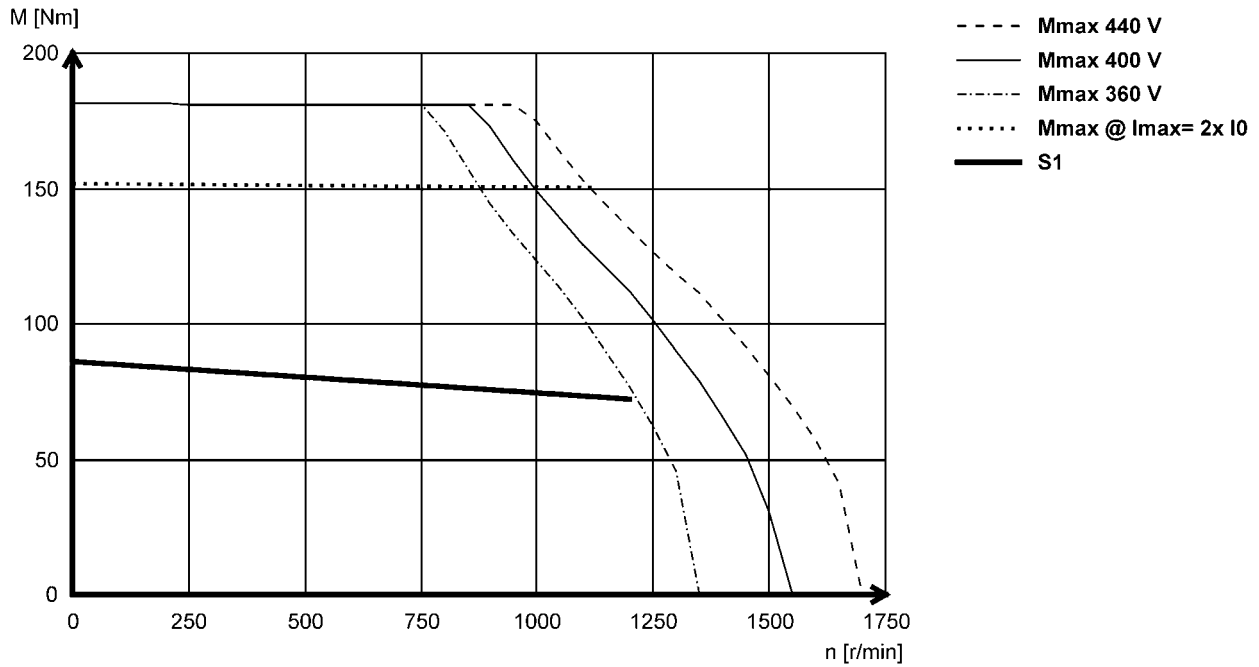

5.1

MCS19P14- (non-ventilated)

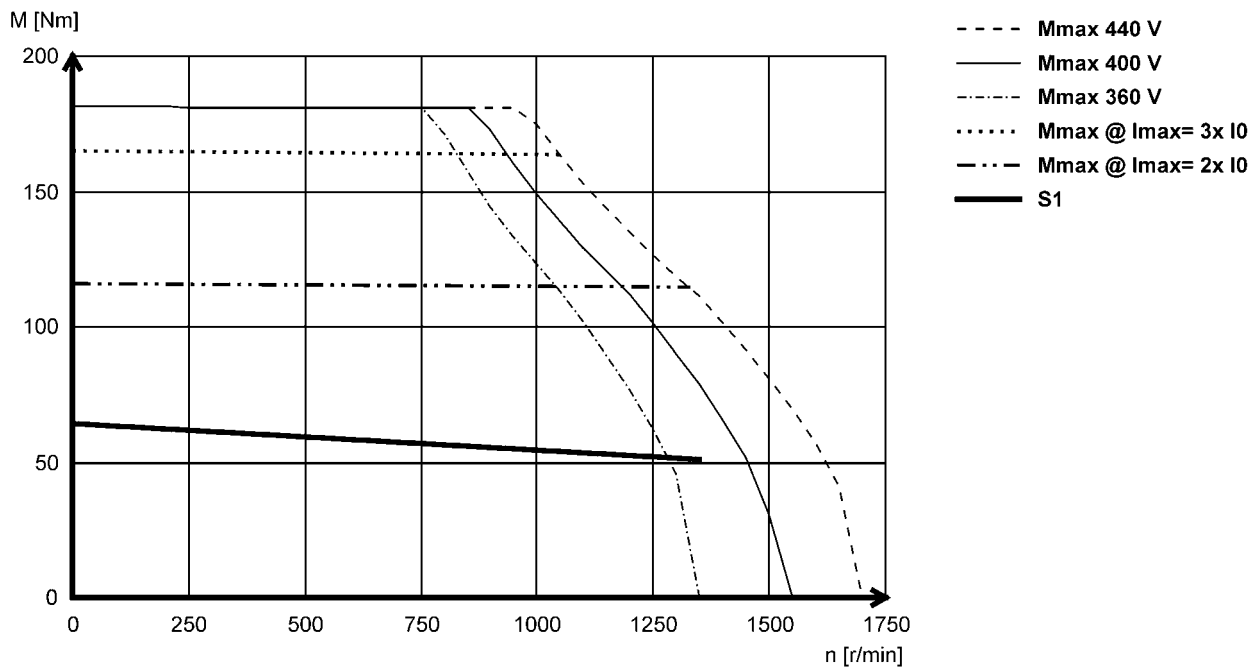

MCS synchronous servo motors

Technical data



Torque characteristics

► The data applies to a mains connection voltage of 3 x 400 V.

MCS19P29- (forced ventilated)

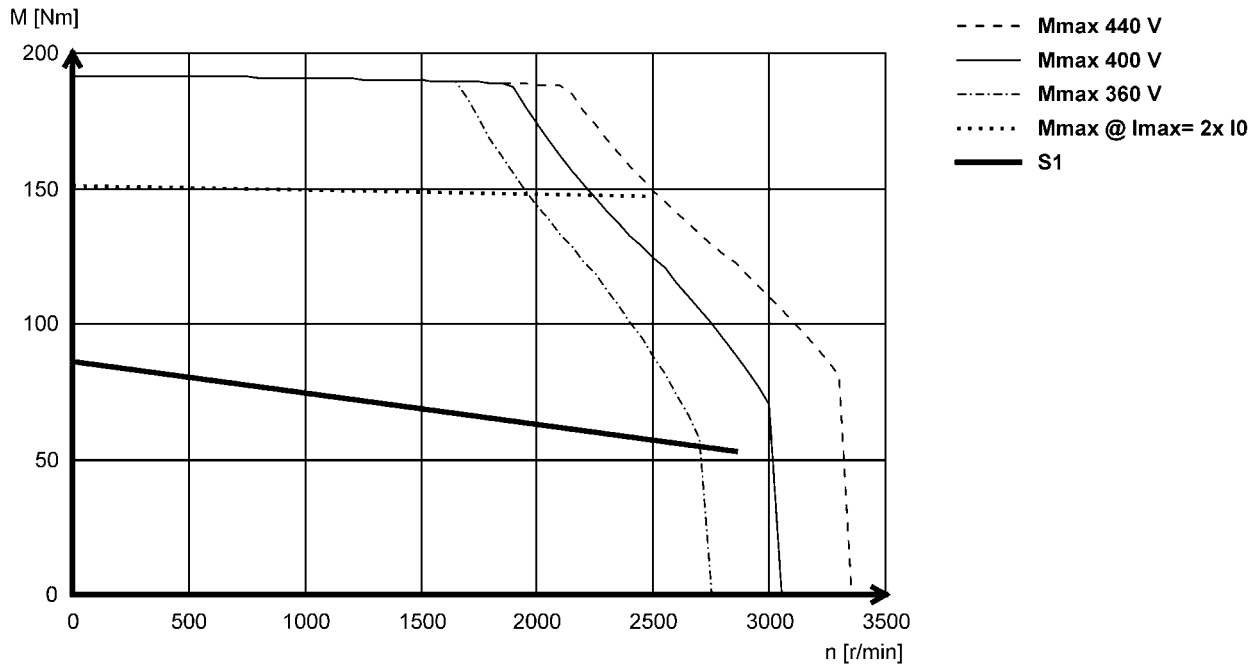

5.1

MCS19P30- (non-ventilated)

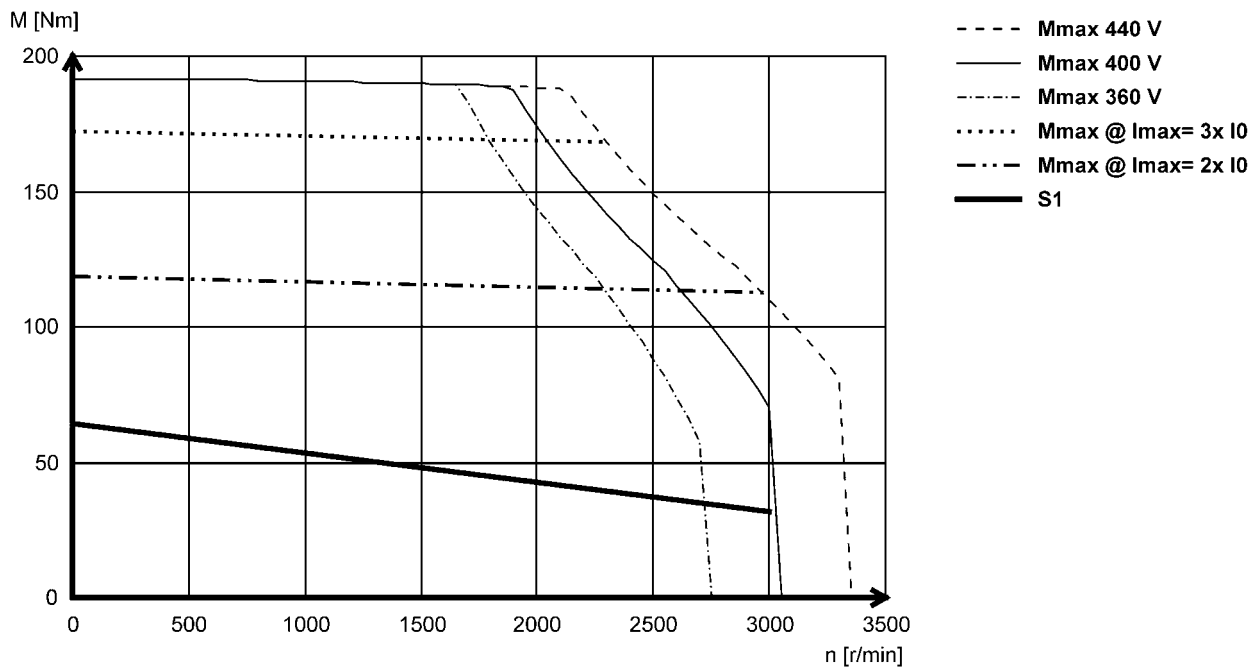

MCS synchronous servo motors

Technical data



Torque characteristics

► The data applies to a mains connection voltage of 3 x 230 V.

MCS06C41L (non-ventilated)

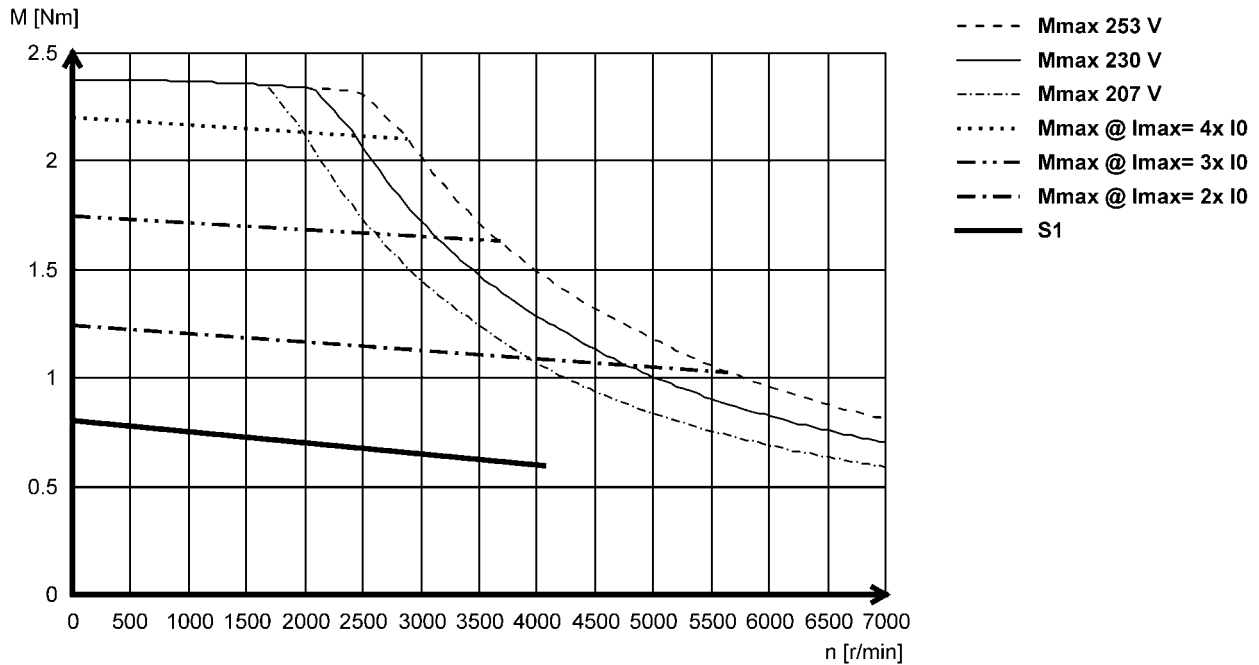

5.1

MCS06C60L (non-ventilated)

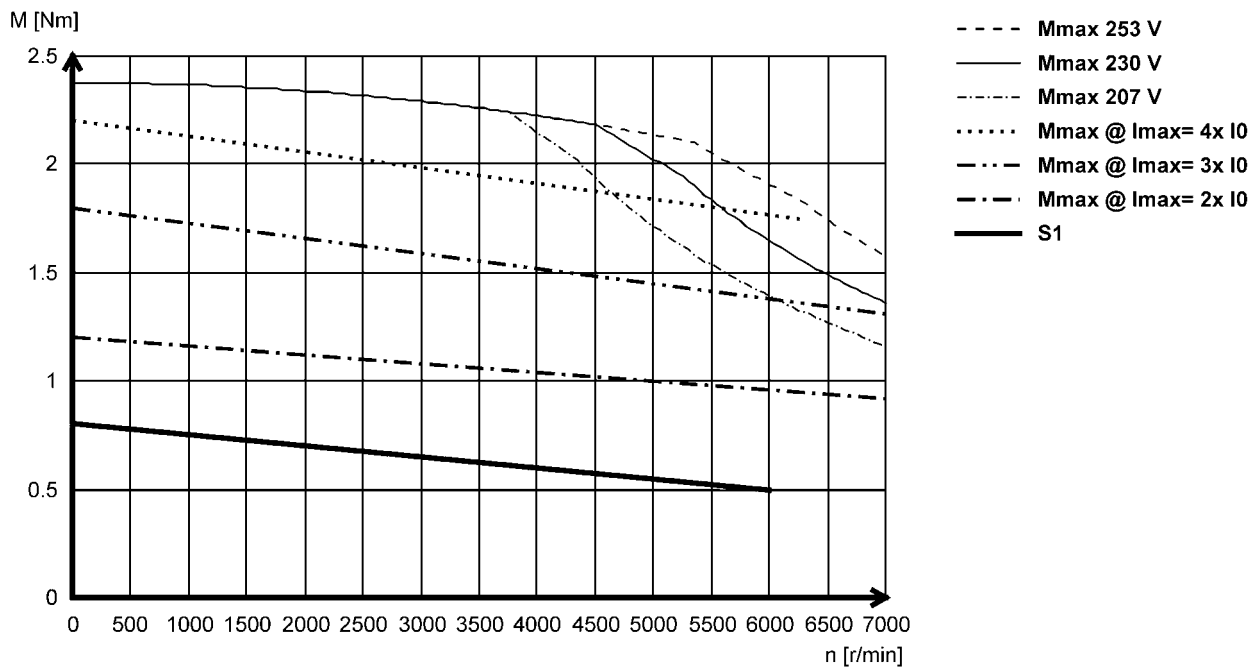

MCS synchronous servo motors

Technical data



Torque characteristics

► The data applies to a mains connection voltage of 3 x 230 V.

MCS06F41L (non-ventilated)

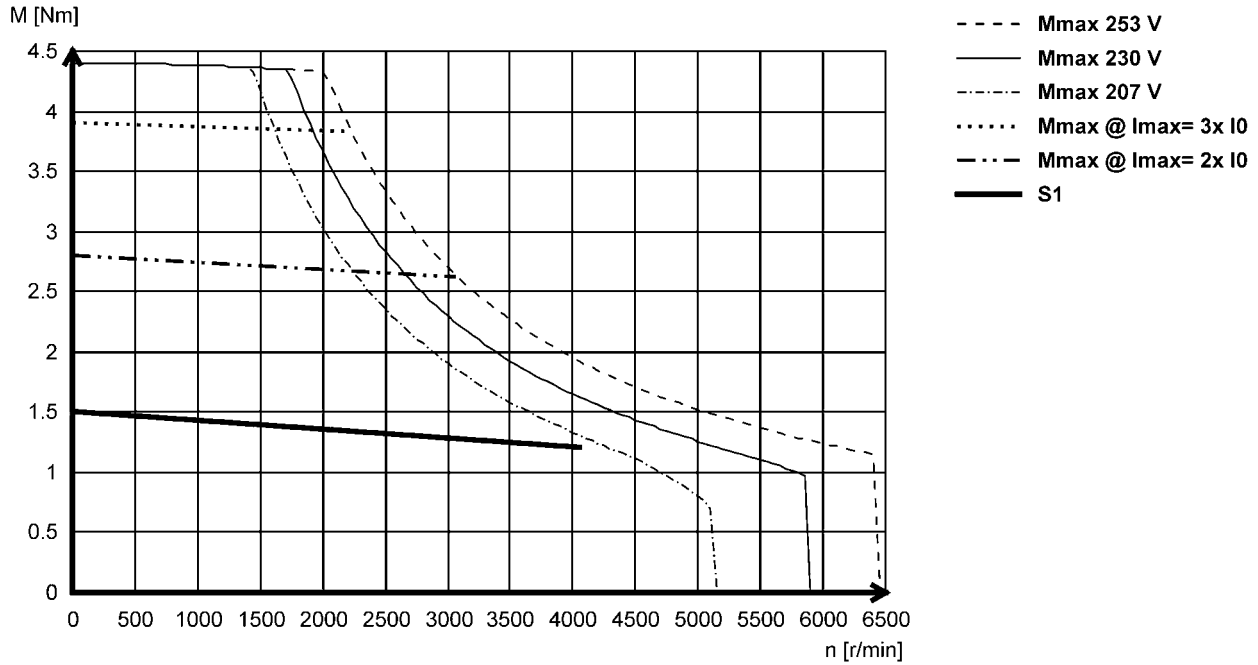

5.1

MCS06F60L (non-ventilated)

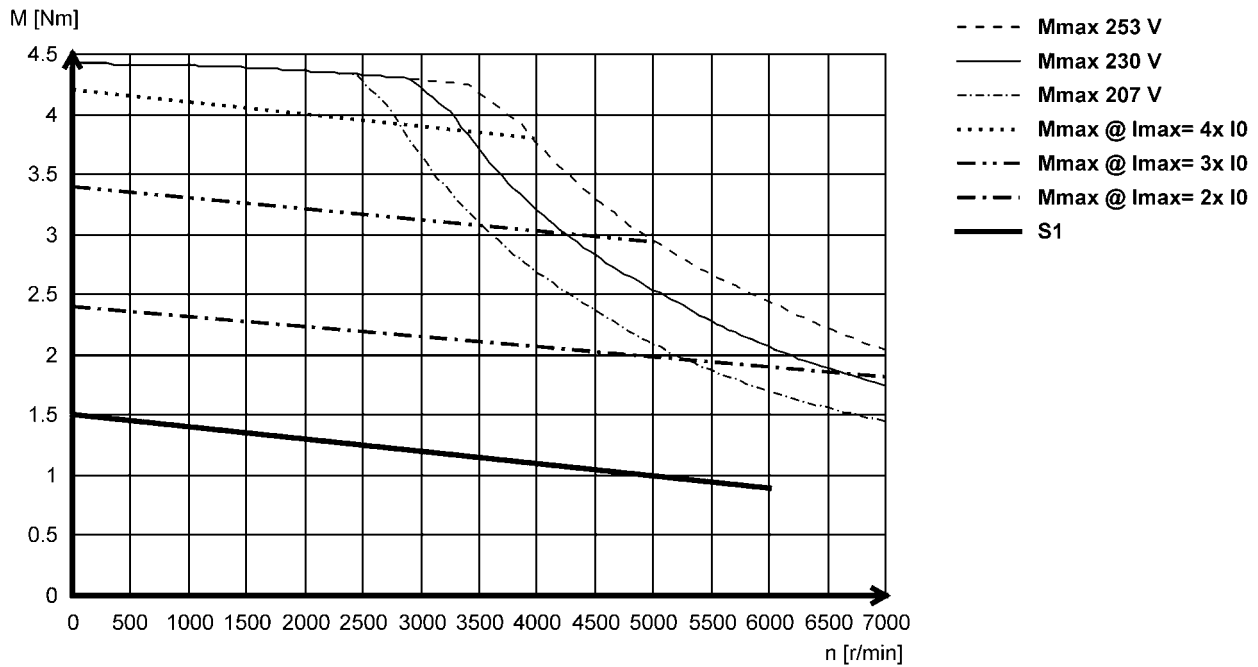

MCS synchronous servo motors

Technical data



Torque characteristics

► The data applies to a mains connection voltage of 3 x 230 V.

MCS06I41L (non-ventilated)

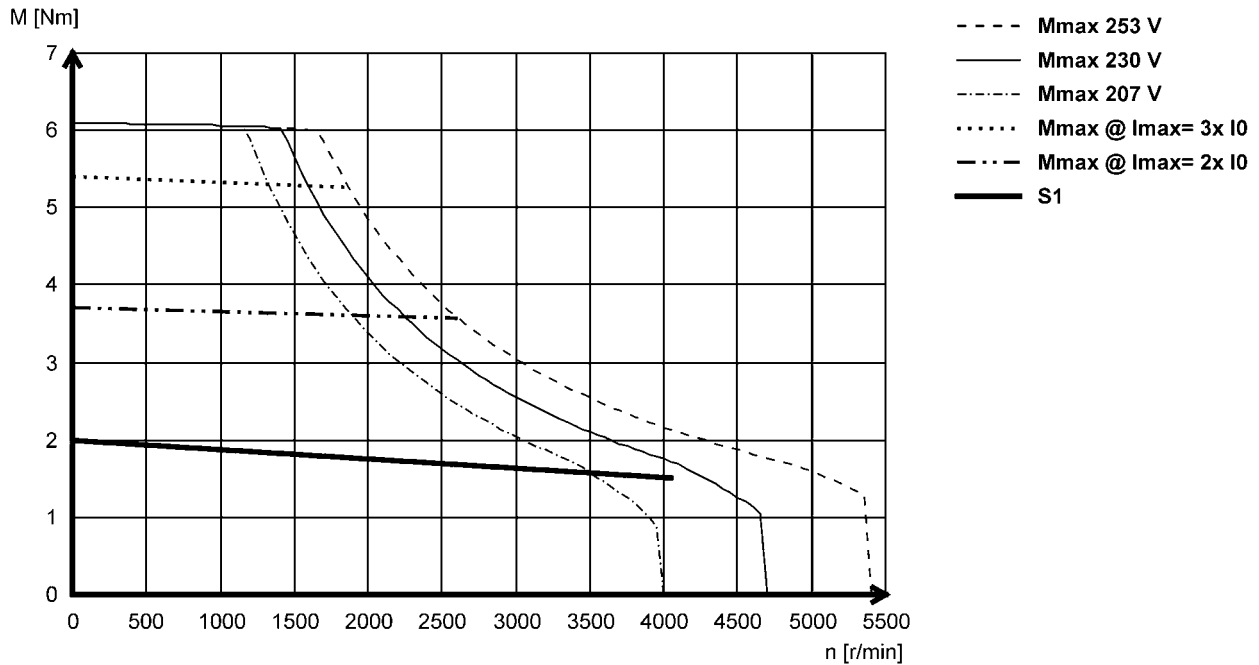

5.1

MCS06I60L (non-ventilated)

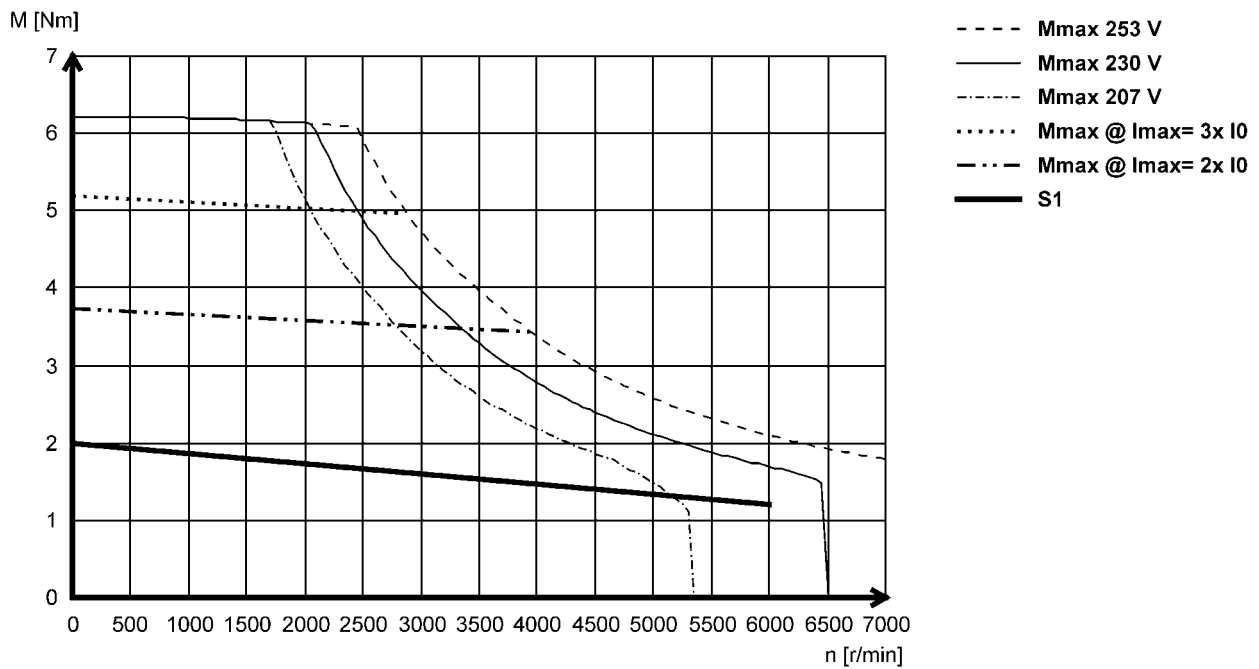

MCS synchronous servo motors

Technical data



Torque characteristics

► The data applies to a mains connection voltage of 3 x 230 V.

MCS09D41L (non-ventilated)

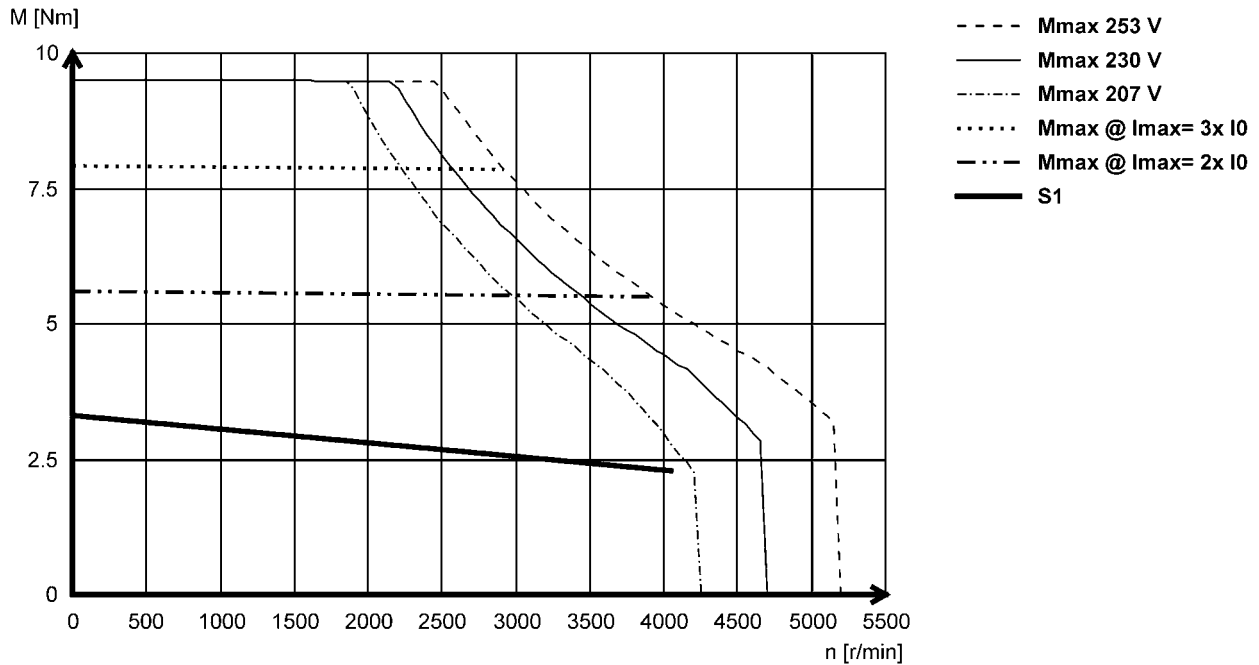

5.1

MCS09D60L (non-ventilated)

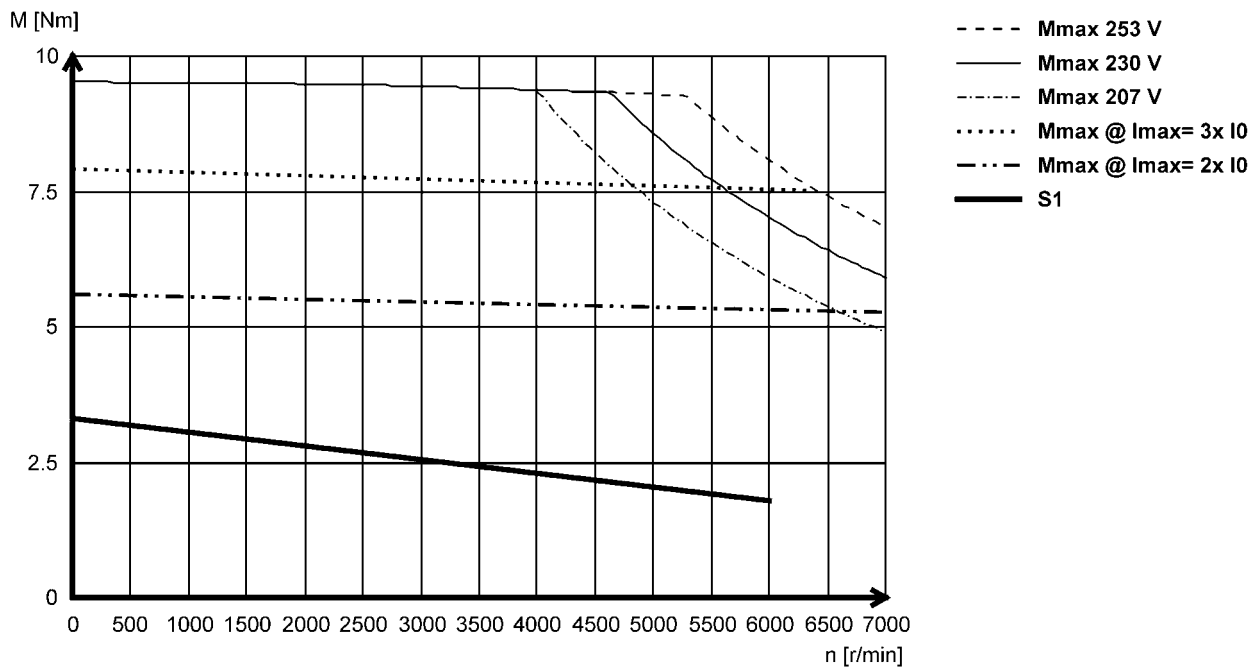

MCS synchronous servo motors

Technical data



Torque characteristics

► The data applies to a mains connection voltage of 3 x 230 V.

MCS09F38L (non-ventilated)

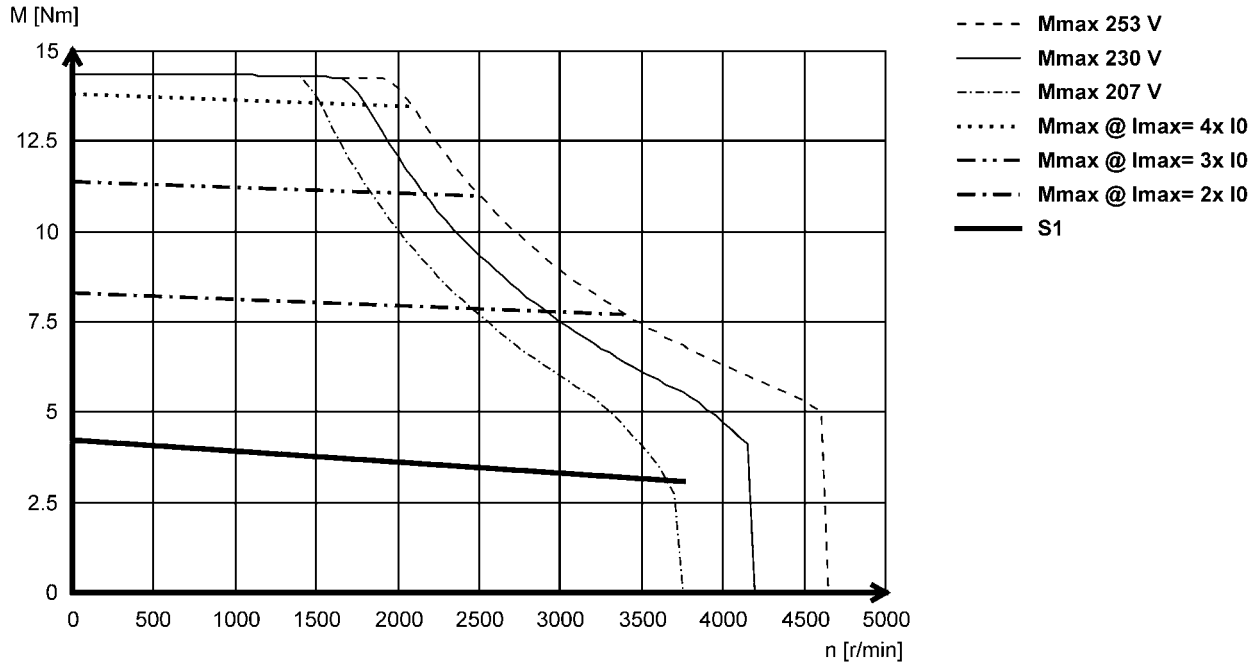

5.1

MCS09F60L (non-ventilated)

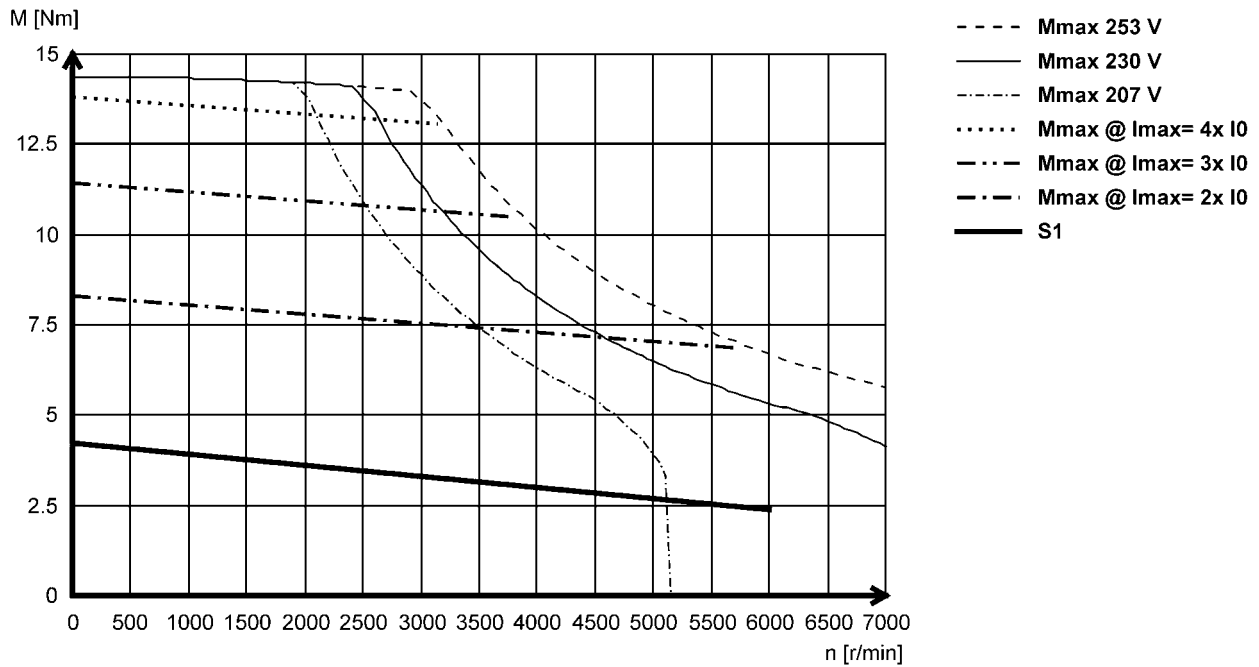

MCS synchronous servo motors

Technical data



Torque characteristics

► The data applies to a mains connection voltage of 3 x 230 V.

MCS09H41L (non-ventilated)

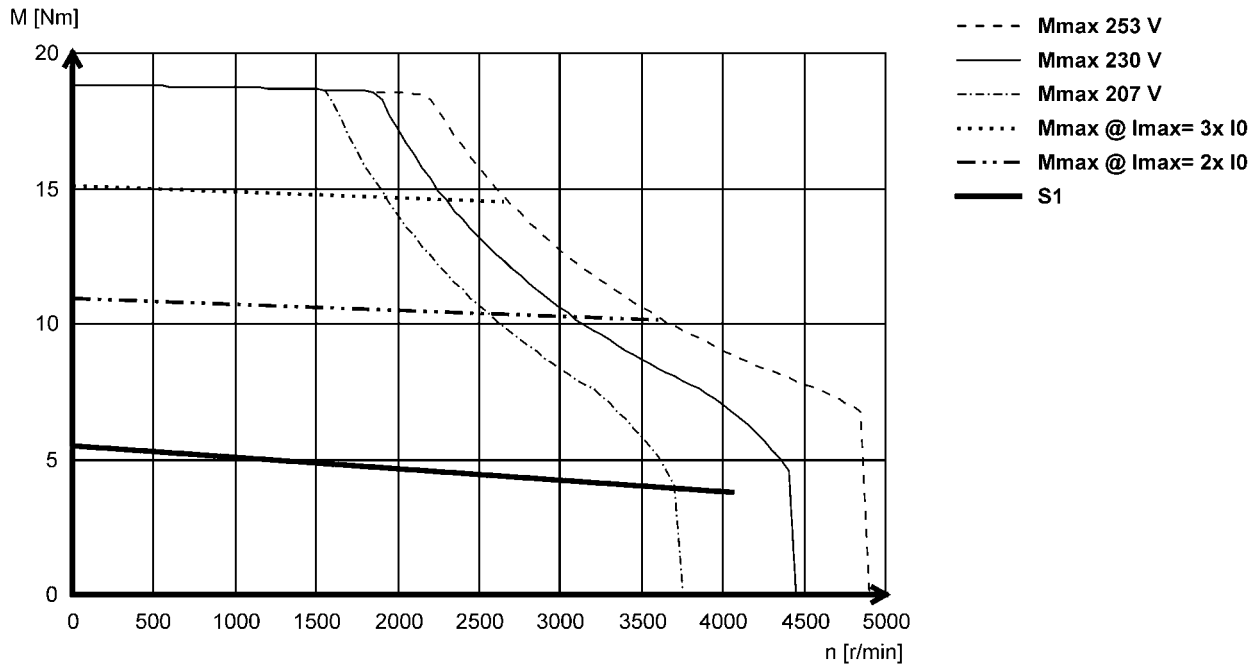

5.1

MCS09H60L (non-ventilated)

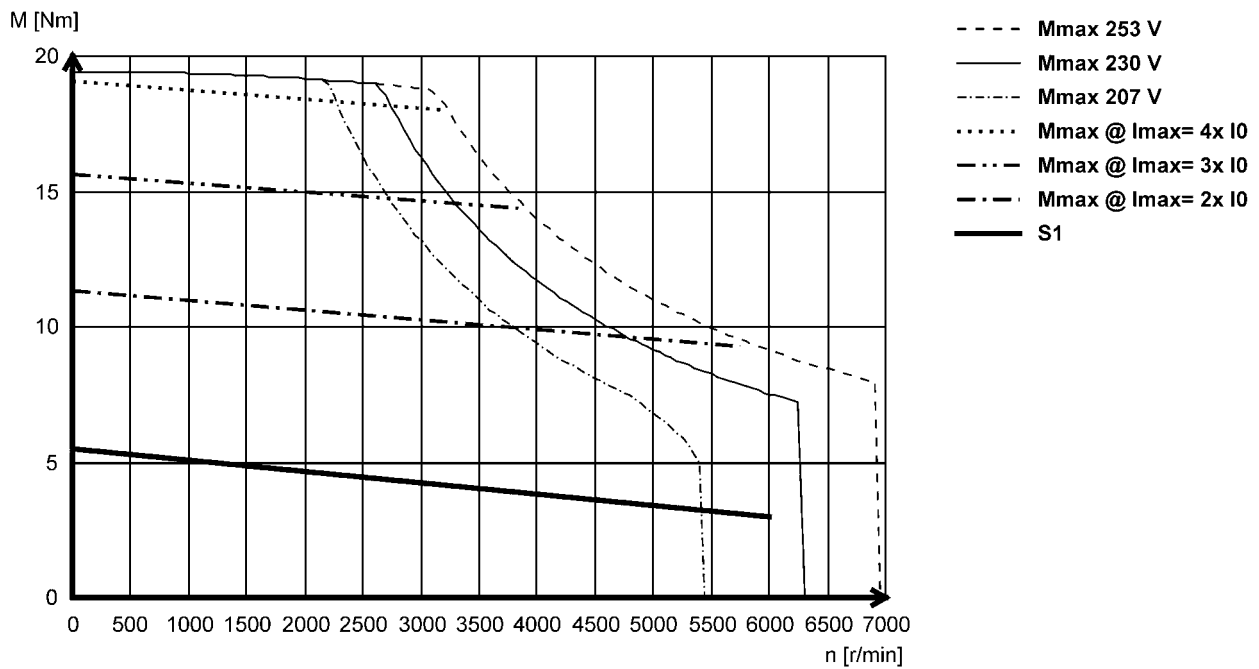

MCS synchronous servo motors

Technical data



Torque characteristics

► The data applies to a mains connection voltage of 3 x 230 V.

MCS09L41L (non-ventilated)

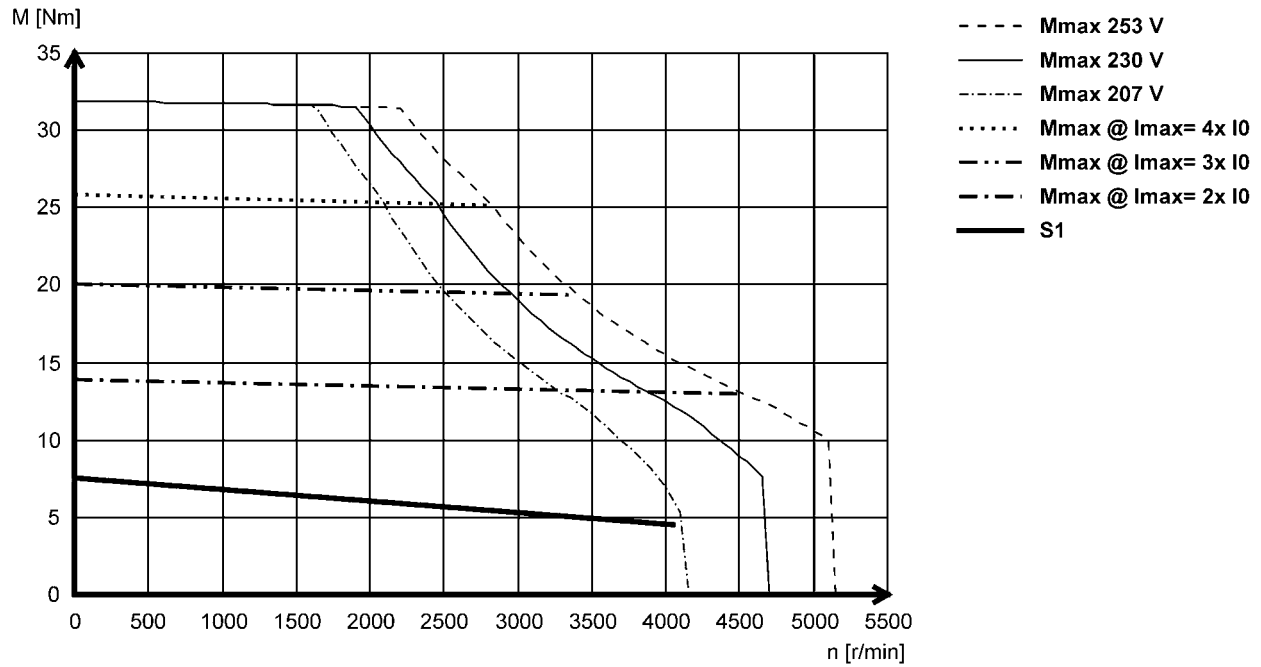

MCS synchronous servo motors

Technical data



Torque characteristics

► The data applies to a mains connection voltage of 3 x 230 V.

MCS12D20L (non-ventilated)

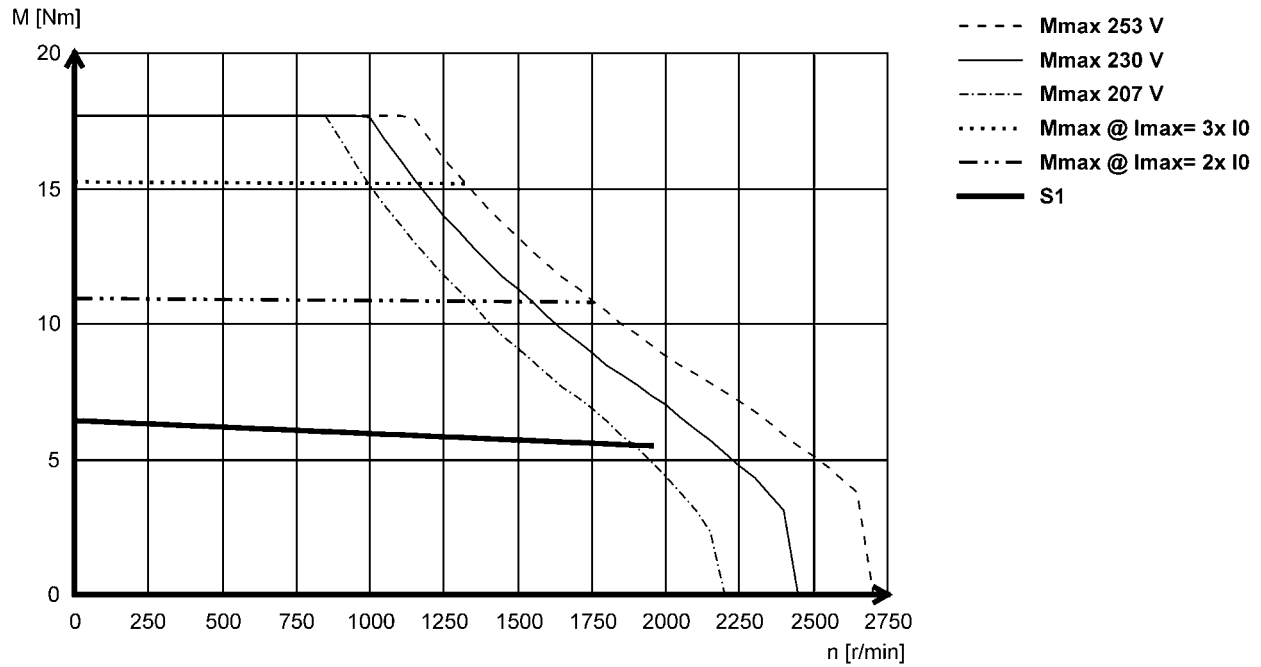

5.1

MCS12D41L (non-ventilated)

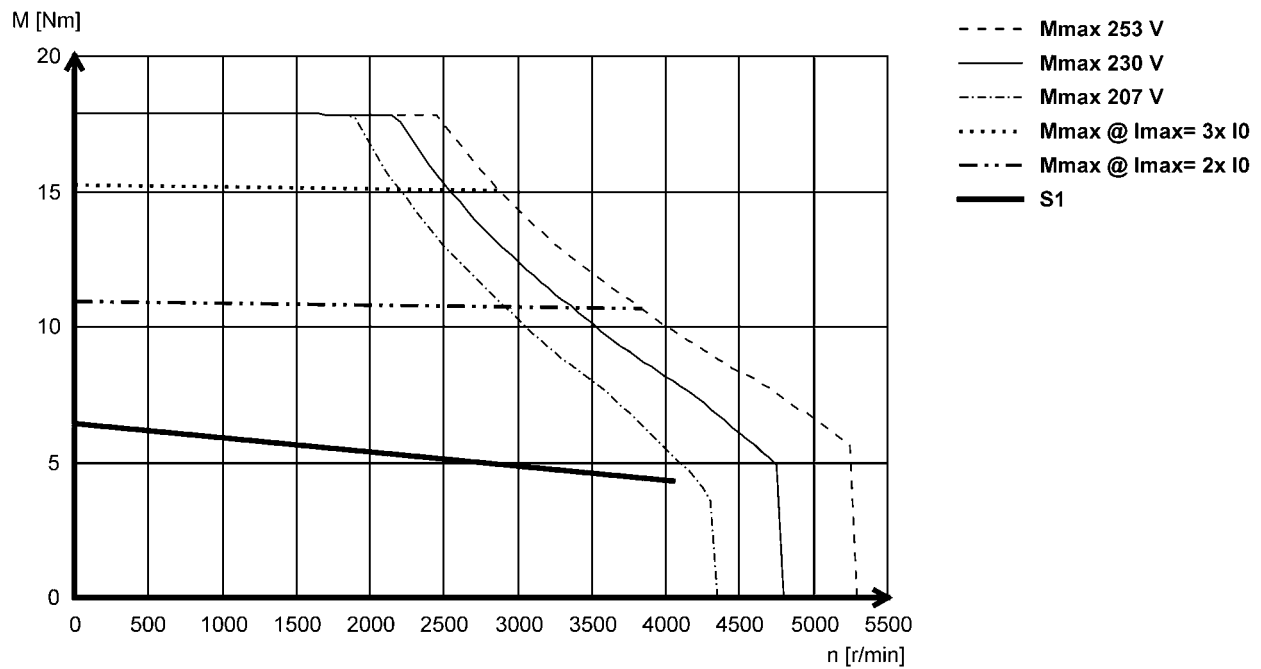

MCS synchronous servo motors

Technical data



Torque characteristics

► The data applies to a mains connection voltage of 3 x 230 V.

MCS12H15L (non-ventilated)

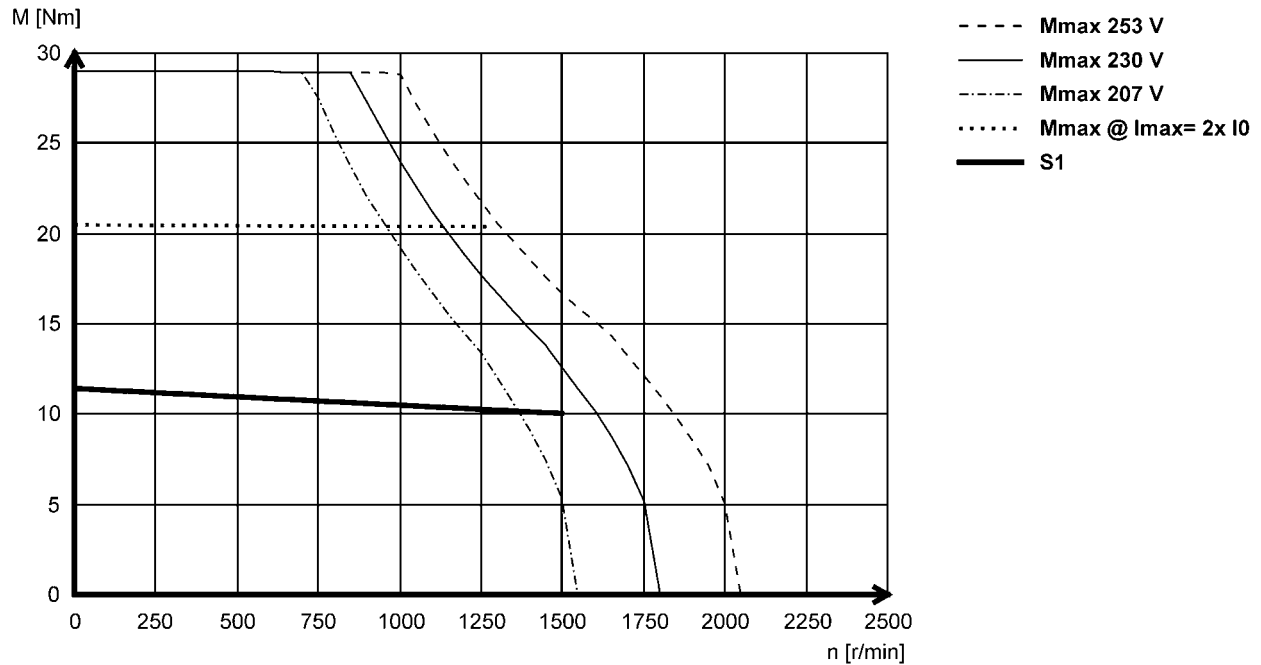

5.1

MCS12H30L- (non-ventilated)

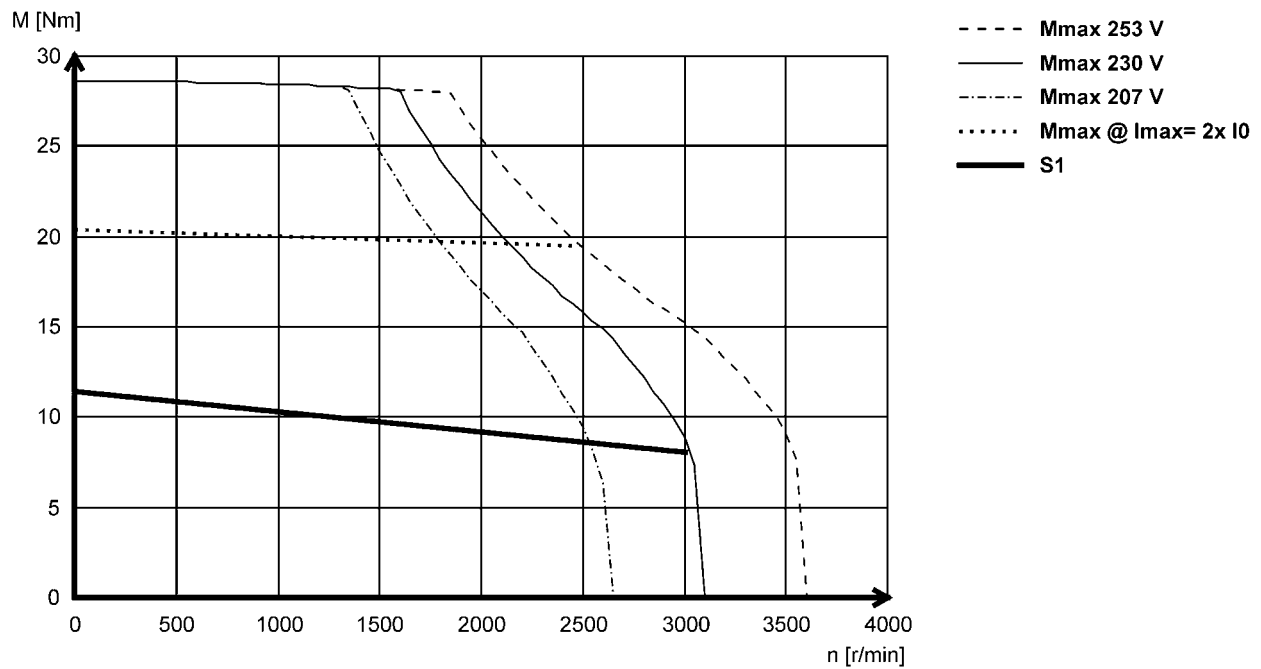

MCS synchronous servo motors

Technical data



Torque characteristics

► The data applies to a mains connection voltage of 3 x 230 V.

MCS12L20L (non-ventilated)

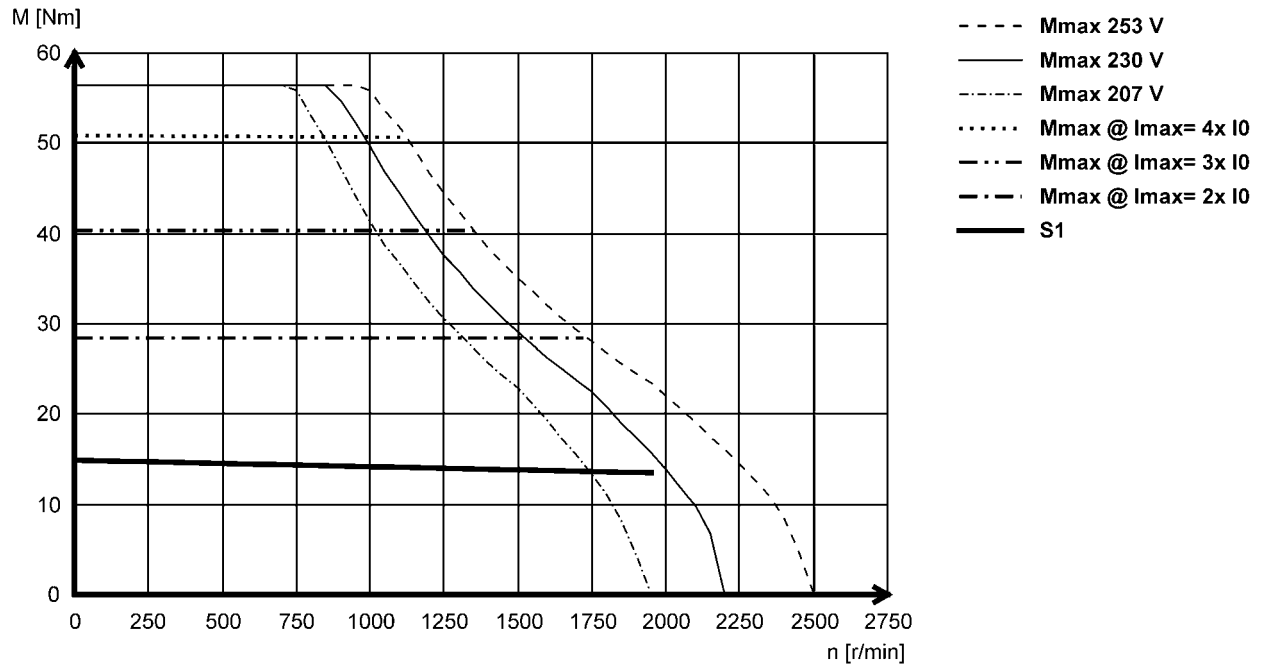

MCS synchronous servo motors

Technical data



Dimensions, self-ventilated

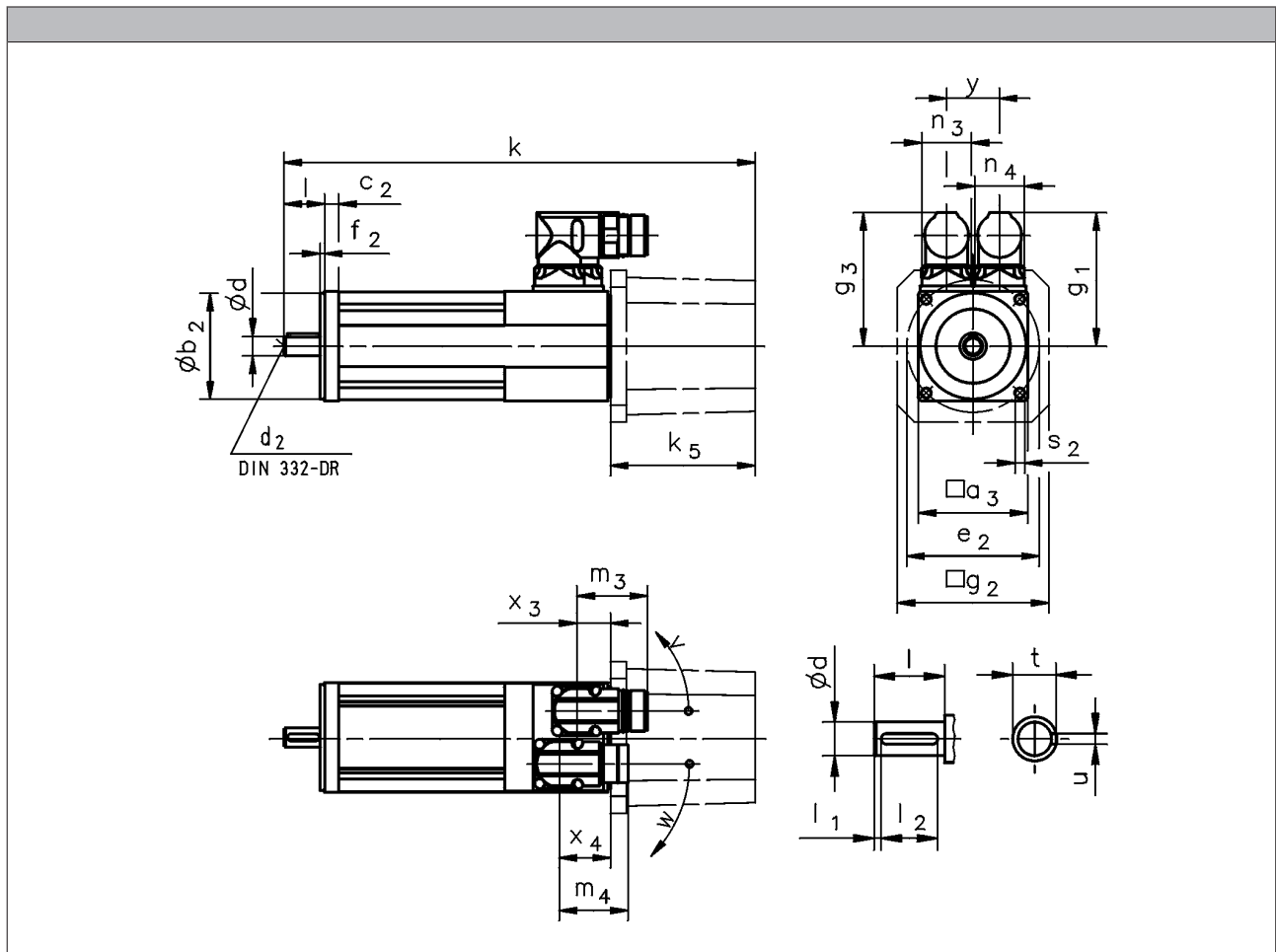

5.1

			MCS06C	MCS06F	MCS06I
R□□ / C40 B0	k	[mm]	155	185	215
R□□ / C40 P□	k	[mm]	174	204	233
SR□ / SV□ / E□□ B0	k	[mm]	237	266	297
SR□ / SV□ / E□□ P□	k	[mm]	255	285	315
SR□ / SV□ / E□□	k_5	[mm]		82	
	g_2	[mm]		86	
SKM B0	k	[mm]	190	220	250
SKM P□	k	[mm]	209	239	268
SKM	k_5	[mm]		35	
	g_2	[mm]		62	

- ▶ Speed / angle sensor: R□□ / C□□ / S□□ / E□□
- ▶ Brake: B0 / P□

MCS synchronous servo motors

Technical data



Dimensions, self-ventilated

	g ₁	g ₃	x ₃	x ₄	m ₃	m ₄	n ₃	n ₄	y	v	w
	[mm]	[mm]	[mm]	[mm]	[mm]	[mm]	[mm]	[mm]	[mm]	[°]	[°]
MCS06	77	77	19	29	40	40	28	28	30	190	230

	d	d ₂	l	l ₁	l ₂	u	t
	k6		-0.7 ... 0.3				
	[mm]	[mm]		[mm]	[mm]	[mm]	[mm]
MCS06	11	M4	23	2.0	18	4.0	12.5

	a ₃	b ₂	c ₂	e ₂	f ₂	s ₂
		j6				
	[mm]	[mm]	[mm]	[mm]	[mm]	[mm]
MCS06	62	60	8	75	2.5	5.5

MCS synchronous servo motors

Technical data



Dimensions, self-ventilated

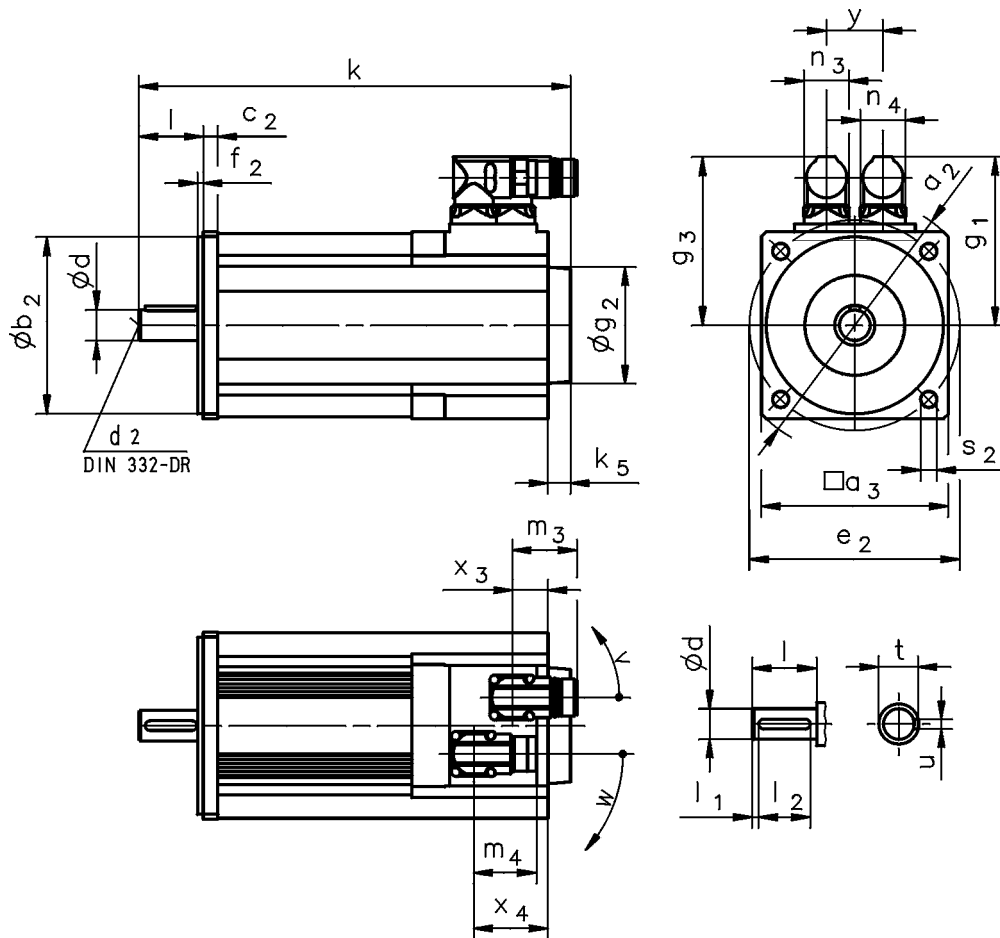

5.1

			MCS09D	MCS09F	MCS09H	MCS09L	MCS12D	MCS12H	MCS12L
R□□ / C40 B0	k	[mm]	213	233	253	293	228	268	308
R□□ / C40 P□	k	[mm]	233	253	273	313	248	288	328
R□□ / C40	k_5	[mm]	13			14			
	g_2	[mm]	67			72			
SR□ / SV□ / E□□ B0	k	[mm]	264	284	304	344	277	317	357
SR□ / SV□ / E□□ P□	k	[mm]	284	304	324	364	297	337	377
SR□ / SV□ / E□□	k_5	[mm]	64			63			
	g_2	[mm]	81			89			
SKM B0	k	[mm]	233	253	273	313	248	288	328
SKM P□	k	[mm]	253	273	293	333	268	308	248
SKM	k_5	[mm]	33			34			
	g_2	[mm]	67			72			

- Speed / angle sensor: R□□ / C□□ / S□□ / E□□
- Brake: B0 / P□

MCS synchronous servo motors

Technical data



Dimensions, self-ventilated

	g_1	g_3	x_3	x_4	m_3	m_4	n_3	n_4	y	v	w
	[mm]	[mm]	[mm]	[mm]	[mm]	[mm]	[mm]	[mm]	[mm]	[°]	[°]
MCS09	90	90	20	44	40	40	28	28	35	195	260
MCS12	105	105	22	46							

	d	d_2	l	l_1	l_2	u	t
	k_6		-0.7 ... 0.3				
	[mm]	[mm]		[mm]	[mm]	[mm]	[mm]
MCS09	14	M5	30	2.5	25	5.0	16.0
MCS12	19	M6	40	4.0	32	6.0	21.5

	a_2	a_3	b_2	c_2	e_2	f_2	s_2
			j_6				
	[mm]	[mm]	[mm]	[mm]	[mm]	[mm]	[mm]
MCS09	120	89	80	8	100	3.0	7.0
MCS12	160	116	110	9	130	3.5	10.0

MCS synchronous servo motors

Technical data



Dimensions, self-ventilated

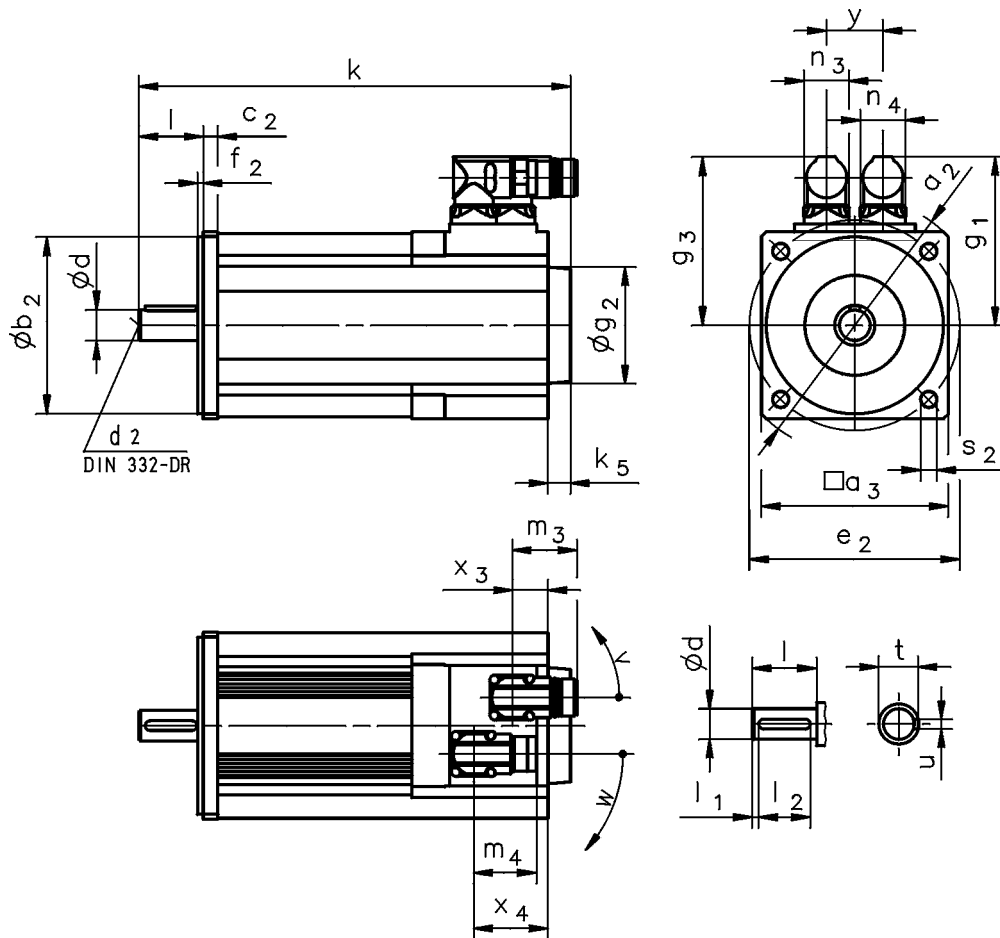

5.1

			MCS14D	MCS14H	MCS14L	MCS14P	MCS19F	MCS19J	MCS19P	
R□ / C40 B0	k	[mm]	251	291	331	371	280	320	380	
R□ / C40 P□	k	[mm]	279	319	359	399	314	364	424	
R□ / C40	k_5	[mm]	24				15			
	g_2	[mm]	78				78			
SR□ / SV□ / E□□ B0	k	[mm]	301	341	381	421	329	369	429	
SR□ / SV□ / E□□ P□	k	[mm]	329	369	409	449	363	413	473	
SR□ / SV□ / E□□	k_5	[mm]	74				64			
	g_2	[mm]	101				101			
SKM B0	k	[mm]	269	309	349	389	299	339	399	
SKM P□	k	[mm]	297	337	377	417	333	383	443	
SKM	k_5	[mm]	42				34			
	g_2	[mm]	78				78			

- Speed / angle sensor: R□□ / C□□ / S□□ / E□□
- Brake: B0 / P□

MCS synchronous servo motors

Technical data



Dimensions, self-ventilated

	g ₁	g ₃	x ₃	x ₄	m ₃	m ₄	n ₃	n ₄	y	v	w	
	[mm]	[mm]	[mm]	[mm]	[mm]	[mm]	[mm]	[mm]	[mm]	[°]	[°]	
MCS14D15-	117	117	24	48	40	40	28	28	35	195	260	
MCS14D36-												
MCS14H15-												
MCS14H32-												
MCS14L15-												
MCS14L32-	146	126	29	36		75				45	180	205
MCS14P14-	117	117	24	48		40				28	195	260
MCS14P32-	146	126	29	36		75				45	180	205
MCS19F14-	142	142	24 51 ¹⁾	48 75 ¹⁾		40				28	195	260
MCS19F30-	171	151	29 56 ¹⁾	36 63 ¹⁾		75				45	180	205
MCS19J14-	142	142	24 51 ¹⁾	48 75 ¹⁾	40	28	195	260				
MCS19J30-	171	151	29 56 ¹⁾	36 63 ¹⁾	75	45	180	205				
MCS19P14-	142	142	24 51 ¹⁾	48 75 ¹⁾	40	28	195	260				
MCS19P30-	171	151	29 56 ¹⁾	36 63 ¹⁾	75	45	180	205				

	d	d ₂	l	l ₁	l ₂	u	t
	k6		-0.7 ... 0.3				
	[mm]	[mm]		[mm]	[mm]	[mm]	[mm]
MCS14	24	M8	50	5.0	40	8.0	27.0
MCS19	28	M10	60		50		31.0

	a ₂	a ₃	b ₂	c ₂	e ₂	f ₂	s ₂
			j6				
	[mm]	[mm]	[mm]	[mm]	[mm]	[mm]	[mm]
MCS14	188	143	130	13	165	3.5	12.0
MCS19	250	192	180	11	215	4.0	14.0

¹⁾ On version with brake (P□)

MCS synchronous servo motors

Technical data



Dimensions, forced ventilated

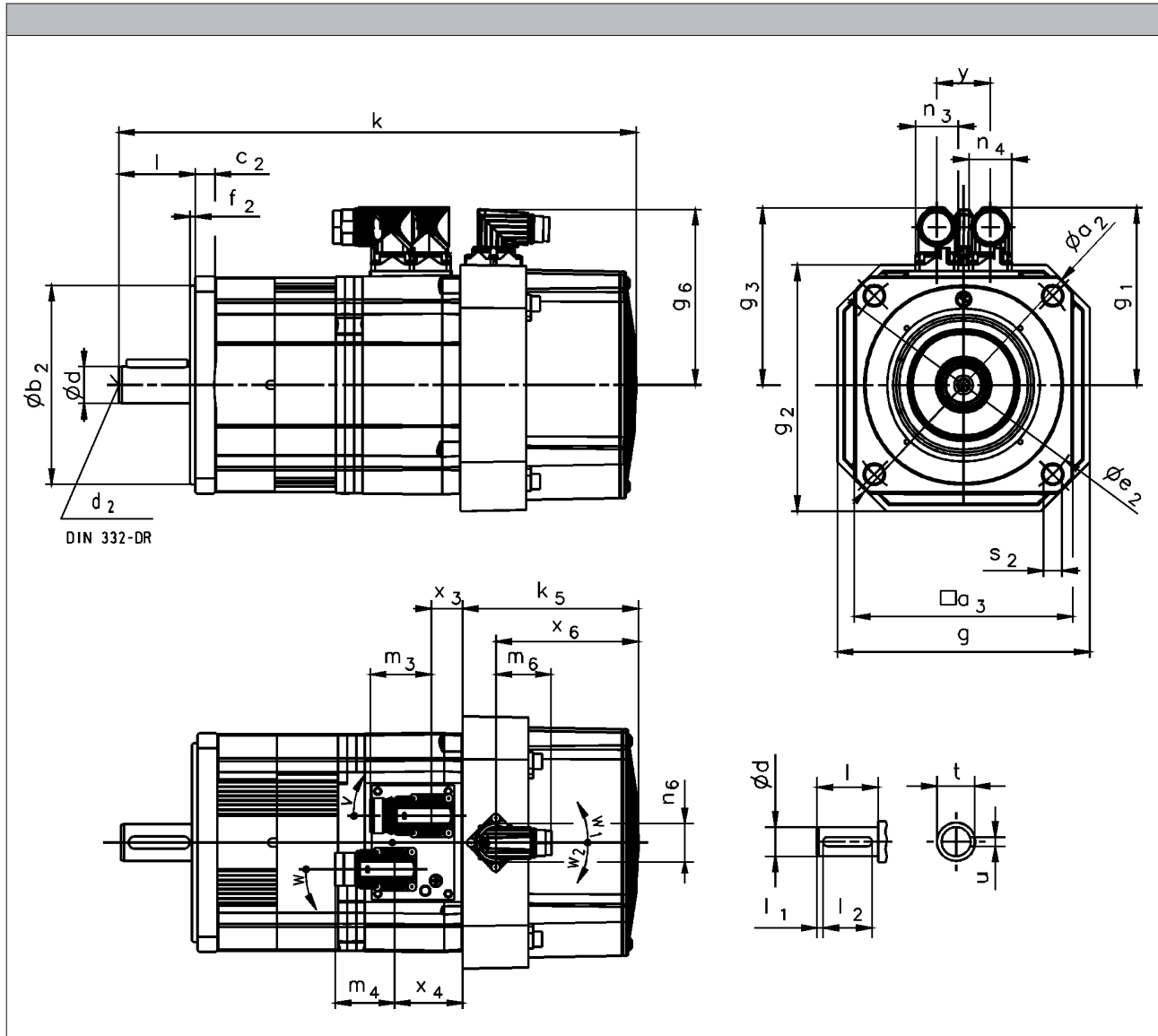

5.1

			MCS12D	MCS12H	MCS12L	MCS14D	MCS14H	MCS14L	MCS14P	MCS19F	MCS19J	MCS19P
R□□ / C40 B0	k	[mm]	301	341	381	339	379	419	459	387	427	487
R□□ / C40 P□	k	[mm]	321	361	401	368	408	448	488	421	471	531
R□□ / C40	k ₅	[mm]		92				115			126	
S□□ / E□□ B0	k	[mm]	344	384	424	392	432	472	512	425	465	525
S□□ / E□□ P□	k	[mm]	364	404	444	421	461	501	541	459	509	569
S□□ / E□□	k ₅	[mm]		135				169			165	
	g	[mm]		140				167			212	
	g ₂	[mm]		140				163			210	

- ▶ Speed / angle sensor: R□□ / C□□ / S□□ / E□□
- ▶ Brake: B0 / P□

MCS synchronous servo motors

Technical data



Dimensions, forced ventilated

	g ₁	g ₃	g ₆	x ₃	x ₄	x ₆	m ₃	m ₄	m ₆	n ₃	n ₄	n ₆	y	v	w	w ₁	w ₂	
	[mm]	[mm]	[mm]	[mm]	[mm]	[mm]	[mm]	[mm]	[mm]	[mm]	[mm]	[mm]	[mm]	[°]	[°]	[°]	[°]	
MCS12D17	105	105	107	16	40	67		40										
MCS12D35																		
MCS12H14																		
MCS12H34																		
MCS12L17																		
MCS12L39																		
MCS14D14	117	117	115	20	44	93	40	40	37	28			35	160	160	120	130	
MCS14D30																		
MCS14H12																		
MCS14H28	146	126		24	31		75											45
MCS14L14	117	117		20	44		40											28
MCS14L30	146	126		24	31		75											45
MCS14P11	117	117	20	44	40	28												
MCS14P26	146	126	24	31	75	45												
MCS19F12	142	142	19 46 ¹⁾	43 70 ¹⁾	40	28												
MCS19F29	171	151	142	24 51 ¹⁾	31 58 ¹⁾	96	75				45							
MCS19J12																		
MCS19J29																		
MCS19P12																		
MCS19P29																		

5.1

	d	d ₂	l	l ₁	l ₂	u	t
	k6		-0.7 ... 0.3				
	[mm]	[mm]		[mm]	[mm]	[mm]	[mm]
MCS12	19	M6	40	4.0	32	6.0	21.5
MCS14	24	M8	50	5.0	40	8.0	27.0
MCS19	28	M10	60		50		31.0

	a ₂	a ₃	b ₂	c ₂	e ₂	f ₂	s ₂
			j6				
	[mm]	[mm]	[mm]	[mm]	[mm]	[mm]	[mm]
MCS12	160	116	110	9	130	3.5	10.0
MCS14	188	143	130	13	165		12.0
MCS19	250	192	180	11	215	4.0	14.0

¹⁾ On version with brake (P□)

MCS synchronous servo motors

Technical data





Permanent magnet holding brake

The synchronous servo motor can be fitted with integral permanent magnet holding brakes.

In the case of permanent magnet brakes, the rated torque applies solely as holding torque at standstill. This is due to the nature of their design. During braking from full motor speed, e.g. in the event of emergency stops, the braking torque is significantly reduced.

As such, they may not be used as safety elements (particularly with lifting axes) without additional measures being implemented.

The brakes are activated when the supply voltage is disconnected (closed-circuit principle). When using the brakes purely as holding brakes, virtually no wear occurs on the friction surfaces.

For traversing axes, adherence to the permissible load/brake motor (J_L / J_{MB}) moment of inertia ensures that the permissible maximum switching rate of the brake will not be exceeded and at least 2,000 emergency stop functions can be performed from a speed of 3,000 rpm.

For lifting axes, the load torque resulting from the weight acts additionally. In this case the specifications for J_L / J_{MB} do not apply.

Caution:

The brakes used are not safety brakes in the sense that a reduction in torque may arise as a result of disruptive factors that cannot be influenced, e.g. oil ingress.

The ohmic voltage drop along the cable must be taken into consideration in long motor supply cables and must be compensated for by a higher voltage at the line input.

The following applies for Lenze system cables:

$$U[V] = U_B[V] + 0.08 \frac{[V]}{[A] \cdot [m]} \cdot l_{lg}[m] \cdot I_B[A]$$

If no suitable voltage (incorrect value, incorrect polarity) is applied to the brake, the brake will be applied and can be overheated and destroyed by the motor continuing to rotate.

The shortest switching times of the brakes are achieved by DC switching of the voltage. A spark suppressor is required to suppress interference and to increase the service life of the relay contacts here.



Permanent magnet holding brake



Permanent magnet holding brake

Rated data with standard braking torque

	$U_{N,DC}^{3,5)}$	M_N	M_N	M_{av}	$I_N^{2)}$	J	$t_1^{1)}$	$t_2^{1)}$	$Q_E^{4)}$	m	J_{MB}	J_L/J_{MB}
		20 °C	120 °C	120 °C								
	[V]	[Nm]	[Nm]	[Nm]	[A]	[kgcm ²]	[ms]	[ms]	[J]	[kg]	[kgcm ²]	
MCS06C	24	2.20	2.00	0.60	0.34	0.12	15.0	30.0	30.0	0.30	0.26	22.1
MCS06F											0.34	16.6
MCS06I											0.42	13.3
MCS09D		8.00	6.00	4.50	0.65	1.07	20.0	40.0	400	0.80	2.17	36.4
MCS09F											2.57	30.5
MCS09H											2.97	26.3
MCS09L											3.87	19.9
MCS12D		12.0	10.0	7.00	0.65	1.07	13.0	43.0	400	0.90	5.07	15.0
MCS12H											8.40	8.70
MCS12L											11.7	5.90
MCS14D		22.0	18.0	8.00	0.88	3.20	15.0	150	640	1.90	11.3	10.5
MCS14H											17.4	6.50
MCS14L											26.6	3.90
MCS14P											37.9	2.40
MCS19F		37.0	32.0	15.0	0.93	12.4	96.0	113	2350	3.10	77.4	5.20

Rated data with increased braking torque

	$U_{N,DC}^{3,5)}$	M_N	M_N	M_{av}	$I_N^{2)}$	J	$t_1^{1)}$	$t_2^{1)}$	$Q_E^{4)}$	m	J_{MB}	J_L/J_{MB}
		20 °C	120 °C	120 °C								
	[V]	[Nm]	[Nm]	[Nm]	[A]	[kgcm ²]	[ms]	[ms]	[J]	[kg]	[kgcm ²]	
MCS09D	24	12.0	10.0	7.00	0.65	1.07	20.0	40.0	400	0.80	2.17	36.4
MCS09F											2.57	30.5
MCS09H											2.97	26.3
MCS09L											3.87	19.9
MCS12D		24.0	19.0	12.0	0.71	3.13	16.0	90.0	890	1.20	7.10	24.3
MCS12H											10.4	16.3
MCS12L											13.7	12.1
MCS14D		37.0	32.0	15.0	0.93	12.4	96.0	113	2350	3.10	20.5	22.2
MCS14H											26.6	16.9
MCS14L											35.8	12.3
MCS14P											47.1	9.10
MCS19J		100	80.0	43.0	1.29	30.0	30.0	90.0	2100	4.30	135	2.20
MCS19P											190	1.20

1) Engagement and disengagement times are valid for rated voltage ($\pm 0\%$) and protective circuit for brakes with varistor for DC switching. The times may increase without a protective circuit.

2) The currents are the maximum values when the brake is cold (value used for dimensioning the current supply). The values for a motor at operating temperature are considerably lower.

3) With 24V DC brake: smoothed DC voltage, ripple $\leq 1\%$.

4) Maximum switching energy per emergency stop at $n = 3000$ r/min for at least 2000 emergency stops.

5) Voltage tolerance: -10% to $+5\%$

MCS synchronous servo motors

Accessories



Resolver

Stator-fed resolver with two stator windings offset by 90° and one rotor winding with transformer winding.

Speed/angle sensor				RS0	RV0
	1)				
Product key				RS0	RV03
Resolution					
Angle			[°]	0.80	
Accuracy					
			[°]	-10 ... 10	
Absolute positioning					
				1 revolution	
Max. speed					
	n_{max}		[r/min]	8000	
Max. input voltage					
DC	$U_{in,max}$		[V]	10.0	
Max. input frequency					
	$f_{in,max}$		[kHz]	4.00	
Ratio					
Stator / rotor			± 5 %	0.30	
Rotor impedance					
	Z_{ro}		[Ω]	51 + j90	
Stator impedance					
	Z_{so}		[Ω]	102 + j150	
Impedance					
	Z_{rs}		[Ω]	44 + j76	
Min. insulation resistance					
At DC 500 V	R		[MΩ]	10.0	
Number of pole pairs				1	
Max. angle error					
			[°]	-10 ... 10	
Inverter assignment					
				i700 E84AVTC E94A ECS EVS93	E84AVTC E94A ECS EVS93

1) 6 - Product key > speed/angle sensor

Speed-dependent safety functions

Suitable for safety function			No	Yes
Max. permissible angular acceleration				
MCS06	α	[rad/s ²]		56000
MCS09 ... MCS19 ²⁾	α	[rad/s ²]		19000
Functional safety				
IEC 61508				SIL3
EN 13849-1				Up to Performance Level e

2) 10 - Single encoder concepts with resolvers



Incremental encoder and SinCos absolute value encoder

Encoder type			TTL incremental	SinCos absolute value		
Speed/angle sensor			C40	EQI	SRS	SVS
Product key			IK4096-5V-T	AM32-5V-E	AS1024-8V-H	AS1024-8V-K2
Encoder type			Single-turn	Multi-turn	Single-turn	
Pulses			4096	32	1024	
Output signals			TTL	1 V _{ss}		
Interfaces				EnDat	Hiperface	
Absolute revolutions			0	4096	1	
Resolution						
Angle ²⁾		[°]	1.30	0.40		
Accuracy						
		[°]	-1 ... 1	-5 ... 5	-0.8 ... 0.8	
Min. input voltage						
DC	U _{in,min}	[V]	4.50	4.75	7.00	
Max. input voltage						
DC	U _{in,max}	[V]	5.50	5.25	12.0	
Max. speed						
	n _{max}	[r/min]	7324	12000	6000	
Max. current consumption						
	I _{max}	[A]	0.075	0.17	0.080	
Limit frequency						
	f _{max}	[kHz]	500	6.00	200	
Inverter assignment						
			E94P	E94A	E84AVTC E94A ECS EVS93	

1) 6 - Product key > speed/angle sensor

2) Inverter-dependent.

Speed-dependent safety functions

Suitable for safety function			No	No	No	Yes
Max. permissible angular acceleration						
MCS06	α	[rad/s ²]				970000
MCS09 ... MCS19	α	[rad/s ²]				240000
Functional safety						
IEC 61508						SIL2
EN 13849-1						Up to Performance Level d

MCS synchronous servo motors

Accessories



Incremental encoder and SinCos absolute value encoder

Encoder type			SinCos absolute value					
Speed/angle sensor			SKM	SRM	SVM	ECN	EQN	
Product key			AM128-8V-H	AM1024-8V-H	AM1024-8V-K2	AS2048-5V-E	AM2048-5V-E	
Encoder type			Multi-turn		Single-turn	Multi-turn		
Pulses			128	1024	2048			
Output signals			1 Vss					
Interfaces			HiPerface		EnDat			
Absolute revolutions			4096		1	4096		
Resolution			0.40					
Angle			[°]					
Accuracy			-1.3 ... 1.3		-0.8 ... 0.8		-0.6 ... 0.6	
Min. input voltage								
DC			$U_{in,min}$	[V]	7.00		4.75	
Max. input voltage								
DC			$U_{in,max}$	[V]	12.0		5.25	
Max. speed								
			n_{max}	[r/min]	9000	6000	12000	
Max. current consumption								
			I_{max}	[A]	0.060	0.080	0.15	0.25
Limit frequency								
			f_{max}	[kHz]	200			
Inverter assignment								
			i700 E84AVTC E94A ECS EVS93	E84AVTC E94A ECS EVS93		E94A		

¹⁾ Inverter-dependent.

Speed-dependent safety functions

Suitable for safety function			No	No	Yes	No	No
Max. permissible angular acceleration							
MCS06			α	[rad/s ²]	970000		
MCS09 ... MCS19			α	[rad/s ²]	240000		
Functional safety							
IEC 61508			SIL2				
EN 13849-1			Up to Performance Level d				

MCS synchronous servo motors

Accessories



Blower

Rated data for 50 Hz

		Degree of protection	Number of phases	U_{min}	U_{max}	$U_{N, AC}$	P_N	I_N
				[V]	[V]	[V]	[kW]	[A]
MCS12	F10	IP54	1	210	240	230	0.019	0.12
	F50			104	122	115	0.018	0.22
MCS14	F10			210	240	230	0.040	0.25
	F50			104	122	115		0.53
MCS19	F10			210	240	230	0.060	0.26
	F50			104	122	115	0.047	0.45

Rated data for 60 Hz

		Degree of protection	Number of phases	U_{min}	U_{max}	$U_{N, AC}$	P_N	I_N
				[V]	[V]	[V]	[kW]	[A]
MCS12	F10	IP54	1	210	240	230	0.019	0.12
	F50			104	122	115	0.018	0.22
MCS14	F10			210	240	230	0.040	0.25
	F50			104	122	115		0.53
MCS19	F10			210	240	230	0.060	0.26
	F50			104	122	115	0.047	0.45

MCS synchronous servo motors

Accessories



Temperature monitoring

The thermal sensors used in the MCS motors continuously monitor the motor temperature. The temperature signal is transmitted over the system cable of the feedback system to the servo controller. Because of the different physical conditions, there are two temperature monitoring mechanisms on the MCS motors (there is no complete motor protection in either case).

MCS06

In case of this motor, the winding temperature of one winding phase is monitored with a KTY 83-110 type thermal sensor.

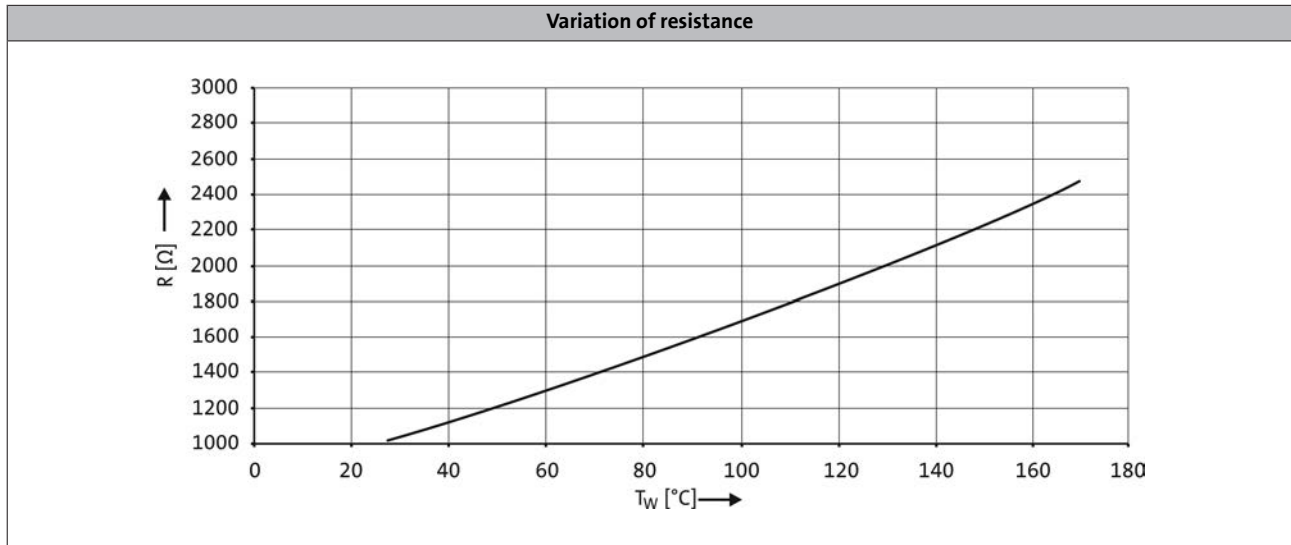

5.1

MCS09 ... 19

These motors are monitored by three thermal sensors (1x KTY 83-110 + 2x PTC 150 °C) connected in series. This means that the temperature of the motor is determined with great accuracy in the permitted operating range and at the same time the overtemperature response configured in the controller is executed in one of the winding phases.

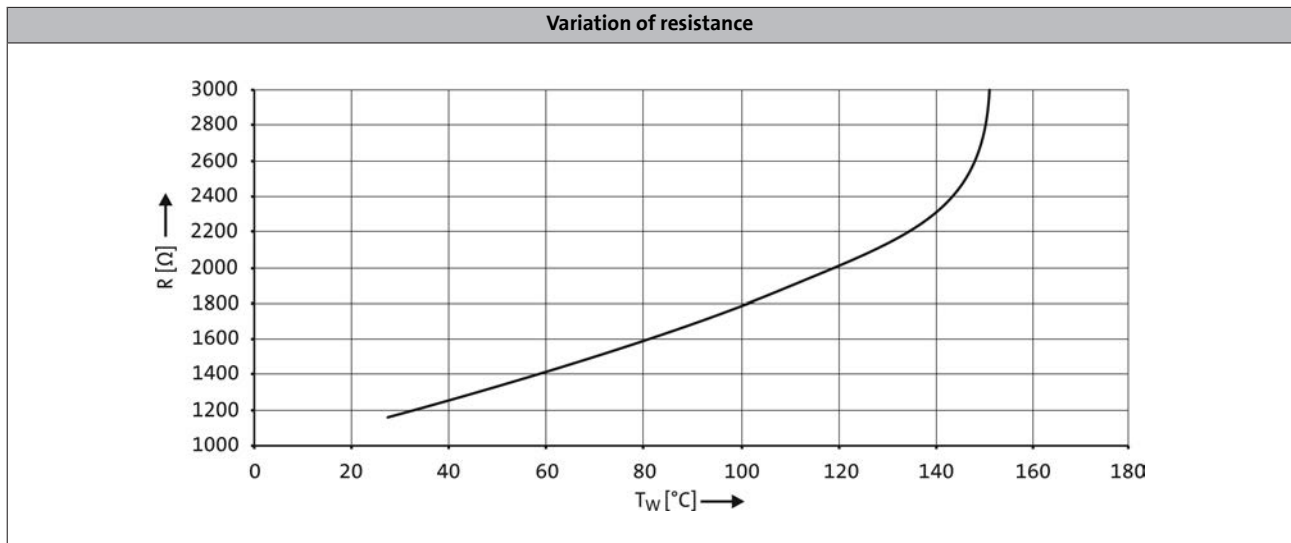

- If the thermal sensor is supplied with a measurement current of 1 mA, the above relationship between the temperature and the resistance applies.

MCS synchronous servo motors

Accessories



Terminal box

If a servo motor is to be connected to an existing cable or plug connectors are not to be used for other reasons, the connection can also be made via a terminal box.

The terminals are designed as tension spring terminals to ensure here the long-term vibration resistance of the cable contacts with adequate contact pressure required.

The terminal boxes have generously dimensioned space for the customer's own wiring and large surface shield connection areas to ensure a secure EMC-compliant connection. The cable outlet may be to the left or to the right, depending on requirements.

It is not possible to attach a terminal box to the MCS06 or to models with the blower.

Connections

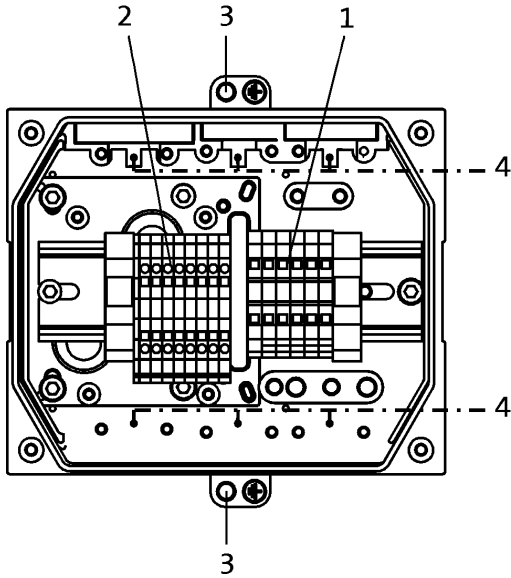

5.1

- 1: Power connection (terminals loadable up to 65 A) + brake connection.
- 2: Angle/speed sensor connection + thermal sensor connection.
- 3: PE connection.
- 4: Large area shield contact.
- 5: Openings for 2x M32, 2x M25, 2x M20 fittings. The openings are plugged and can be opened up as required by the customer.

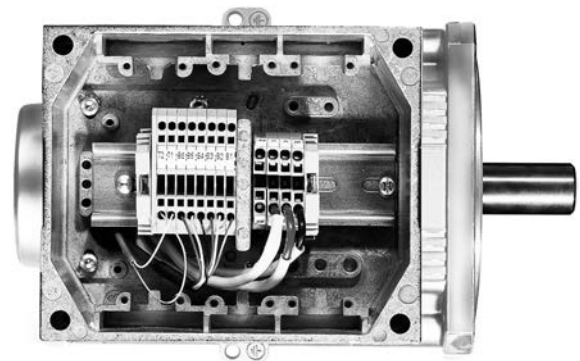

MCS synchronous servo motors

Accessories



Terminal box

Dimensions

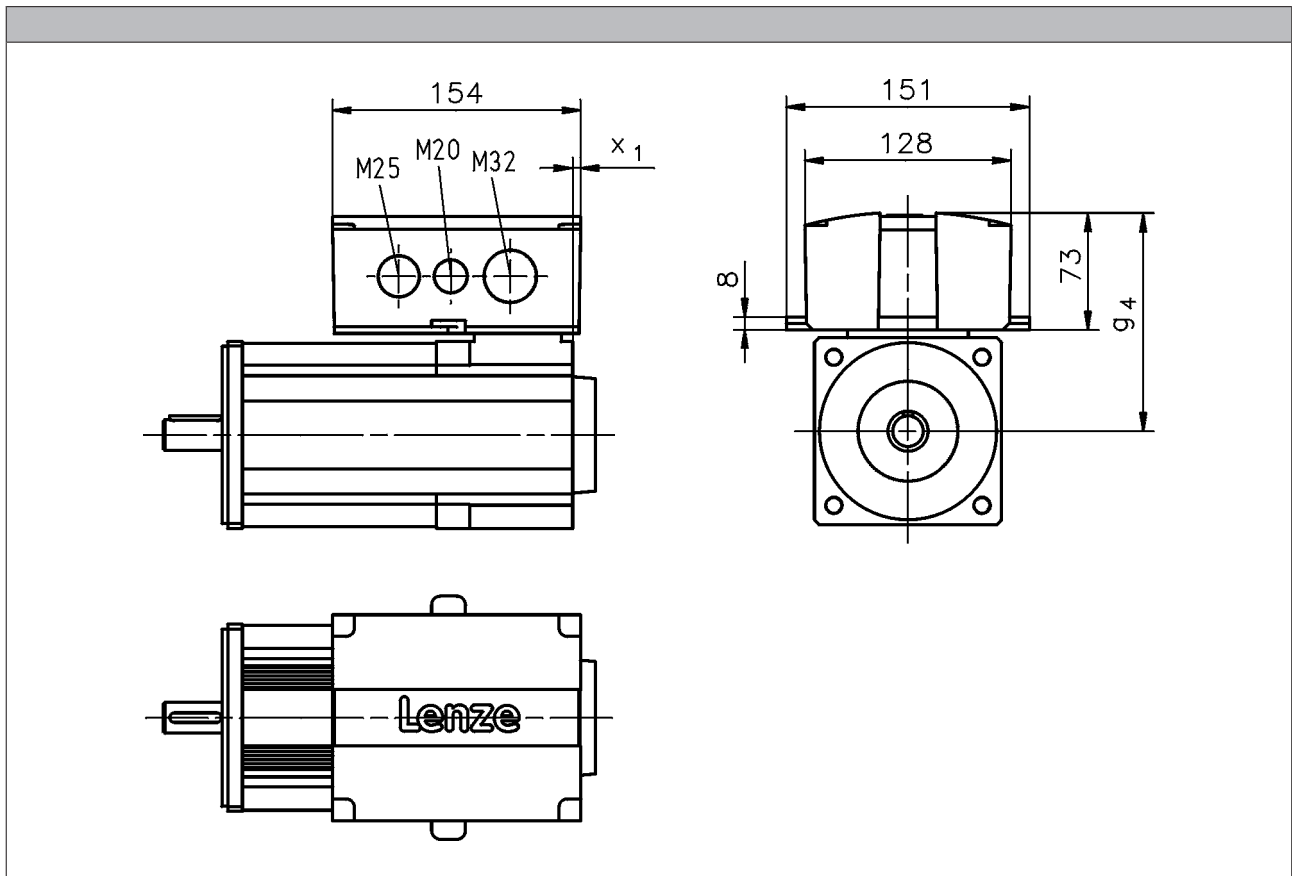

	\varnothing_4 [mm]	x_1 [mm]
MCS09	121	8
MCS12	136	5
MCS14	147	3
MCS19	172	

MCS synchronous servo motors

Accessories



ICN connector

An ICN connector is used as standard for the electrical connection to the servo motors.

A connector is used for the connection of motor and brake. The connections to the feedback system/temperature monitoring and the blower each employ a separate connector.

The connectors can be rotated through 270° and are fitted with a bayonet catch for SpeedTec connectors. As the connector fixing is also compatible with conventional union nuts. Existing mating connectors can therefore still be used without difficulty.

Connection for power and brake

► MCS06 to 12

Pin assignment		
Contact	Designation	Meaning
1	BD1	Holding brake +
2	BD2	Holding brake -
PE	PE	PE conductor
4	U	Phase U power
5	V	Phase V power
6	W	Phase W power

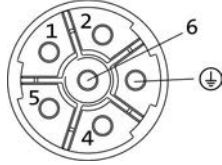

► MCS14 to 19

Pin assignment		
Contact	Designation	Meaning
1		Not assigned
2		
+	BD1	Holding brake +
-	BD2	Holding brake -
PE	PE	PE conductor
U	U	Phase U power
V	V	Phase V power
W	W	Phase W power

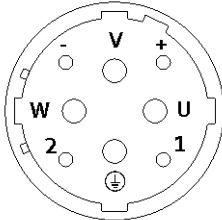

MCS synchronous servo motors

Accessories



ICN connector

Feedback connection

► Resolver

Pin assignment		
Contact	Designation	Meaning
1	+Ref	Transformer windings
2	-Ref	
3	+VCC ETS	Supply: Electronic nameplate
4	+COS	Cosine stator windings
5	-COS	
6	+SIN	Sine stator windings
7	-SIN	
8		Not assigned
9		
10		
11	+KTY	KTY temperature sensor
12	-KTY	

► Hiperface incremental encoder and SinCos absolute value encoder

Pin assignment		
Contact	Designation	Meaning
1	B	Track B/+SIN
2	A ⁻	Track A inverse/-COS
3	A	Track A/+COS
4	+U _B	Supply +
5	GND	Mass
6	Z ⁻	Zero track inverse/-RS485
7	Z	Zero track/+RS485
8		Not assigned
9	B ⁻	Track B inverse/-SIN
10		Not assigned
11	+KTY	KTY temperature sensor
12	-KTY	

MCS synchronous servo motors

Accessories



ICN connector

Feedback connection

- SinCos absolute value encoder with EnDat interface

Pin assignment		
Contact	Designation	Meaning
1	U _p sensor	Supply: UP sensor
2		Not assigned
3		
4	0 V sensor	Supply: 0 V sensor
5	+KTY	KTY temperature sensor
6	-KTY	
7	+U _B	Supply +
8	Cycle	EnDat interface cycle
9	Cycle ⁻	EnDat interface inverse cycle
10	GND	Mass
11	Shield	Encoder housing screen
12	B	Track B
13	B ⁻	Track B inverse/-SIN
14	Data	EnDat interface data
15	A	Track A
16	A ⁻	Track A inverse
17	Data ⁻	EnDat interface inverse data

5.1

Blower connection

Pin assignment		
Contact	Designation	Meaning
PE	PE	PE conductor
1	U1	Fan
2	U2	
3		Not assigned
4		
5		
6		

Motors

MCM synchronous servo motors

0.6 ... 26.4 Nm

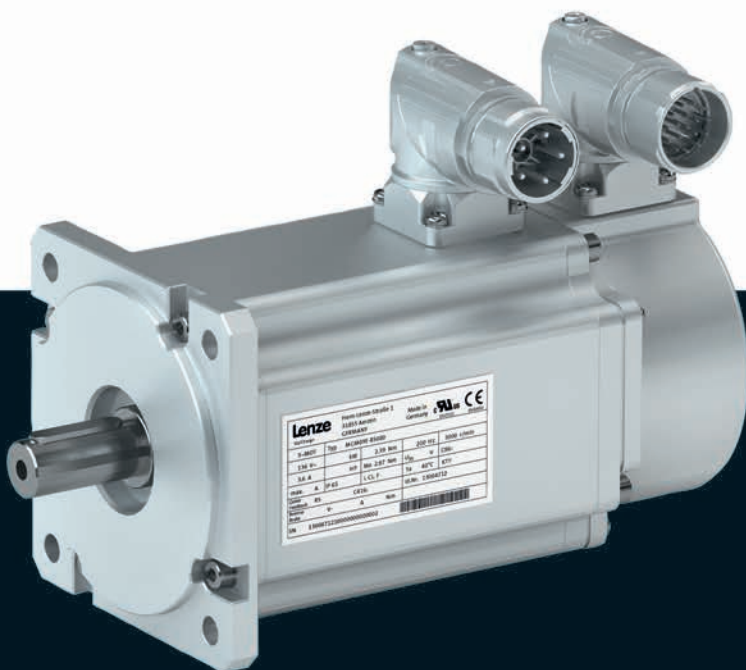

MCM synchronous servo motors



Contents

General information	List of abbreviations	5.2 - 4
	Product key	5.2 - 6
	Product information	5.2 - 7
	Functions and features	5.2 - 8
	Dimensioning	5.2 - 9
Technical data	Standards and operating conditions	5.2 - 13
	Permissible radial and axial forces	5.2 - 14
	Rated data, non-ventilated	5.2 - 15
	Selection tables, Servo-Inverter i700	5.2 - 16
	Selection tables, Servo Drives 9400 HighLine	5.2 - 17
	Selection tables, Inverter Drives 8400 TopLine	5.2 - 18
	Torque characteristics	5.2 - 19
	Dimensions, self-ventilated	5.2 - 23
Accessories	Spring-applied holding brake	5.2 - 27
	Resolver	5.2 - 29
	SinCos absolute value encoder	5.2 - 30
	Temperature monitoring	5.2 - 31
	ICN connector	5.2 - 32

MCM synchronous servo motors

General information



List of abbreviations

$\eta_{100\%}$	[%]	Efficiency
$\cos \phi$		Power factor
du/dt	[kV/ μ s]	Insulation resistance
$F_{ax,-}$	[N]	Min. axial force
$F_{ax,+}$	[N]	Max. axial force
$f_{in,max}$	[Hz]	Max. input frequency
f_{max}	[kHz]	Limit frequency
f_{max}	[kHz]	Max. switching frequency
f_N	[Hz]	Rated frequency
F_{rad}	[N]	Max. radial force
H_{max}	[m]	Site altitude
I_0	[A]	Standstill current
I_{max}	[A]	Max. short-time DC-bus current
I_{max}	[A]	Max. current
I_{max}	[A]	Max. current consumption
I_{max}	[A]	Max. current
I_{max}	[A]	Max. DC-bus current
I_N	[A]	Rated current
J	[kgcm ²]	Moment of inertia
J_{MB}	[kgcm ²]	Moment of inertia
$KE_{LL\ 150\ ^\circ C}$	[V / (1000 r/min)]	Voltage constant
$Kt_{0\ 150\ ^\circ C}$	[Nm/A]	Torque constant
L	[mH]	Mutual inductance
$L_{1\sigma}$	[mH]	Stator leakage inductance
$L_{2\sigma}$	[mH]	Rotor leakage inductance
L_N	[mH]	Rated inductance
m	[kg]	Mass
M_0	[Nm]	Stall torque
$M_{0,max}$	[Nm]	Max. standstill torque
M_{av}	[Nm]	Average dynamic torque
M_{max}	[Nm]	Max. torque
M_N	[Nm]	Rated torque
n_{eto}	[r/min]	Transition speed
n_k	[r/min]	Speed
n_{max}	[r/min]	Max. speed

n_N	[r/min]	Rated speed
P_N	[kW]	Rated power
Q_E	[J]	Maximum switching energy
R	[Ω]	Insulation resistance
R	[Ω]	Min. insulation resistance
R_1	[Ω]	Stator impedance
R_2	[Ω]	Charging resistor
R_2	[Ω]	Rotor impedance
$R_{UV\ 150\ ^\circ C}$	[Ω]	Stator impedance
$R_{UV\ 20\ ^\circ C}$	[Ω]	Stator impedance
$S_{h\u00fc}$	[1/h]	Transition operating frequency
T	[$^\circ C$]	Operating temperature
T	[$^\circ C$]	Rated temperature
T	[$^\circ C$]	Max. ambient temperature of bearing
T	[$^\circ C$]	Max. surface temperature
T	[$^\circ C$]	Max. ambient temperature for transport
T	[$^\circ C$]	Min. ambient storage temperature
T	[$^\circ C$]	Min. ambient temperature for transport
T	[$^\circ C$]	Ambient temperature
t_1	[ms]	Engagement time
t_2	[ms]	Disengagement time
$T_{opr,max}$	[$^\circ C$]	Max. ambient operating temperature
$T_{opr,min}$	[$^\circ C$]	Min. ambient operating temperature
$U_{in,max}$	[V]	Max. input voltage
$U_{in,min}$	[V]	Min. input voltage
U_{max}	[V]	Max. mains voltage
U_{max}	[V]	Min. input voltage
U_{min}	[V]	Min. mains voltage
$U_{N, AC}$	[V]	Rated voltage
$U_{N, DC}$	[V]	Rated voltage
Z_{ro}	[Ω]	Rotor impedance
Z_{rs}	[Ω]	Impedance
Z_{so}	[Ω]	Stator impedance

MCM synchronous servo motors

General information



List of abbreviations

CE	Communauté Européenne
CSA	Canadian Standards Association
DIN	Deutsches Institut für Normung e.V.
EMC	Electromagnetic compatibility
EN	European standard
EAC	Customs union Russia / Belarus / Kazakhstan certificate
IEC	International Electrotechnical Commission
IM	International Mounting Code
IP	International Protection Code
NEMA	National Electrical Manufacturers Association
UkrSEPRO	Certificate for Ukraine
UL	Underwriters Laboratory Listed Product
UR	Underwriters Laboratory Recognized Product
VDE	Verband deutscher Elektrotechniker (Association of German Electrical Engineers)

MCM synchronous servo motors

General information



Product key

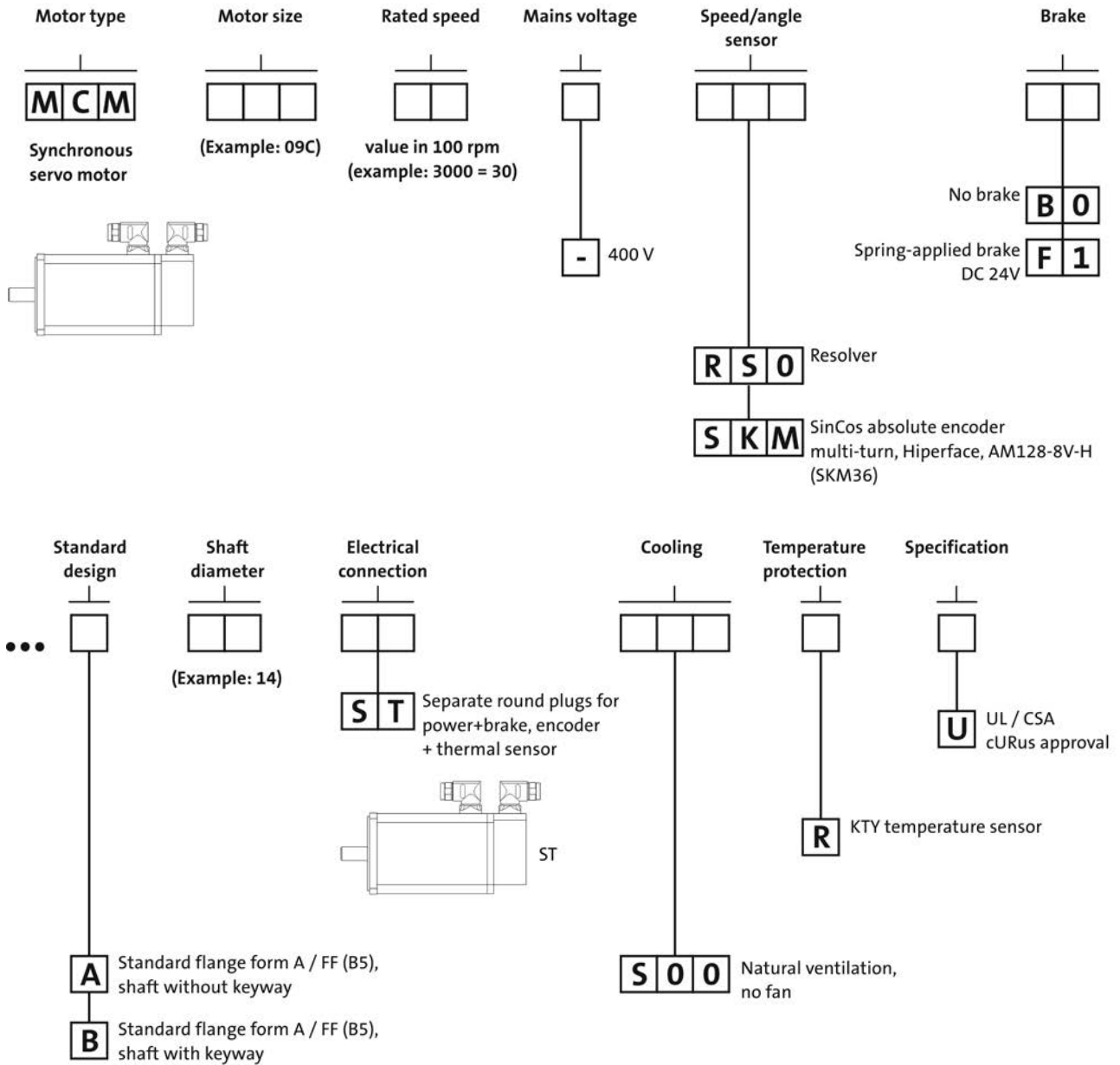

MCM synchronous servo motors

General information



Product information

MCM – the compact synchronous servo motor for applications in positioning, robotics and packaging technology as well as handling systems. In combination with the Servo-Inverters i700, 9400 and 8400 TopLine, the MCM is a powerful drive component within a torque range of 0.6 to 26.4 Nm.

Advantages

- Easy controllability thanks to a favourable mass inertia ratio of the load and the motor
- Excellent smooth running characteristics for exact work results
- A smooth surface of the housing provides for the use in the food industry
- Simplicity thanks to robust resolvers as standard and multiturn SinCos encoders
- Easy installation and servicing thanks to SpeedTec connectors with rotary connector boxes

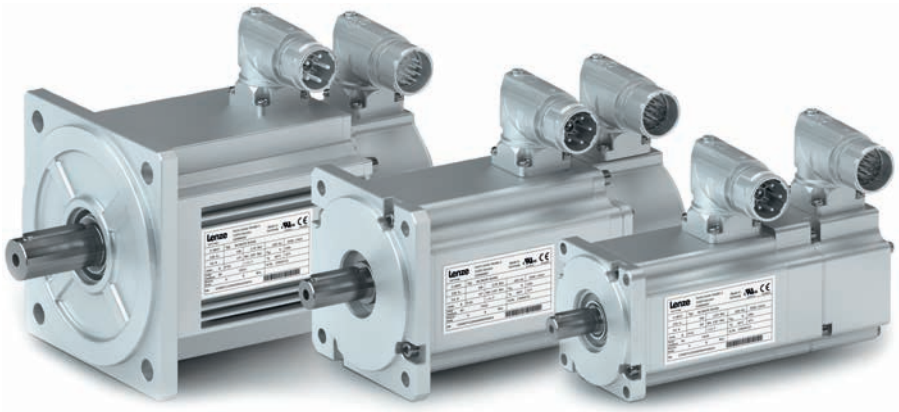

MCM12/MCM09/MCM06 synchronous servo motors

MCM synchronous servo motors

General information



Functions and features

	MCM06	MCM09	MCM12
Design			
	B5-FF75	B5-FF100	B5-FF130
Shaft end (with and without keyway)			
	11 x 23	14 x 30	19 x 40
A end shield	Not oil-tight		
Brake	DC 24 V		
Spring-applied brake			
Speed and angle encoder	Resolver SinCos multi-turn		
Cooling	Naturally ventilated		
Without blower			
Temperature sensor	KTY		
Thermal detector			
Motor connection: plug connector	Power + brake Encoder + thermal sensor		
Shaft bearings	Deep-groove ball bearing with high-temperature resistant grease, sealing disc or cover plate		
Bearing type			
Position of the locating bearing	Non-drive end		
Colour	Not coated		Primed

MCM synchronous servo motors



General information

Dimensioning

Cooling effect of mounting flange

Mounting on a thermally conducting / insulating plate or machine chassis has an influence on heating up the motor, particularly when using naturally ventilated motors.

The motor rating data specified in the catalogue applies when mounting on a steel plate with free convection with the following dimensions:

- MCM06: 270 x 270 mm
- MCM09: 330 x 330 mm
- MCM12: 450 x 450 mm

Vibrational severity

		MCM06	MCM09	MCM12
Vibrational severity				
IEC/EN 60034-14			A	
Maximum r.m.s. value of the vibration velocity	[mm/s]		1.60	

¹⁾ Free suspension

- ▶ at n = 600 to 3,600 rpm

MCM synchronous servo motors

General information



Dimensioning

Concentricity and axial run-out of the mounting flanges and smooth running of the shaft ends

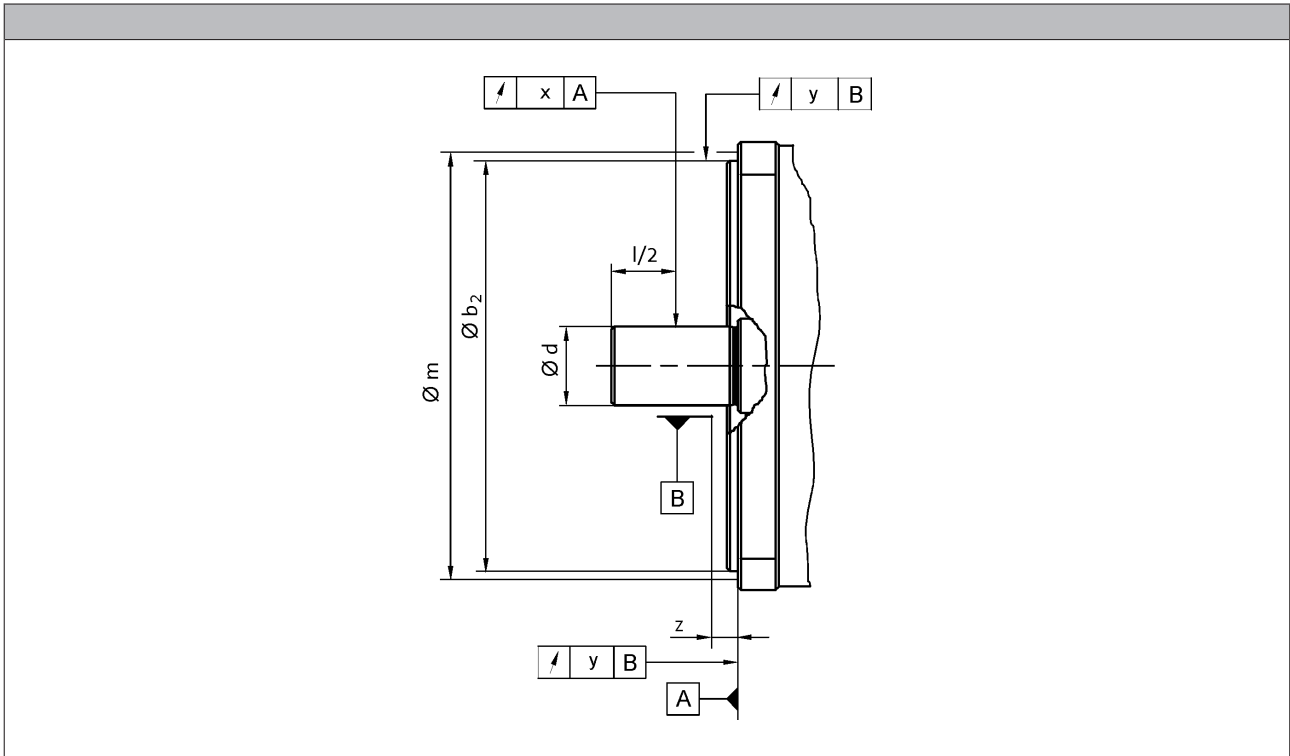

5.2

				MCM06	MCM09	MCM12
Flange size				FF75	FF100	FF130
Dimensions						
	b_2	j_6	[mm]	60	80	110
	d	k_6	[mm]	11	14	19
Distance						
Measuring diameter	m		[mm]	65.0	85.0	115
Dial gauge holder for flange check	z	± 1	[mm]	10.0		
Concentricity				Normal class		
IEC 60072				Normal class		
Value	y		[mm]	0.080		0.10
Axial run-out				Normal class		
IEC 60072				Normal class		
Value	y		[mm]	0.080		0.10
Smooth running				Normal class		
IEC 60072				Normal class		
Value	x		[mm]	0.035		0.040

- Limit values for checking the smooth running of the shaft ends as well as the concentricity and axial run-out of the mounting flange to IEC 60072

MCM synchronous servo motors

General information



Dimensioning

Notes on the selection tables

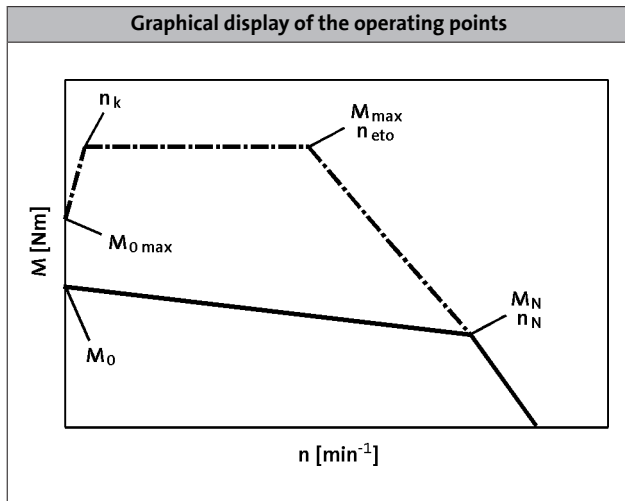

Please note:

- In case of an active load (e.g. vertical drive axes, hoists, test benches, unwinders), $M_{0\ max}$ has to be considered
- In case of a passive load (e.g. horizontal drive axes), $M_{\ max}$ can be usually used
- In case of a speed $< n_k$ and inverter-specifically, the achievable torque $M_{0\ max}$ is smaller than $M_{\ max}$
- In case of a speed $n = 0$, the standstill torque M_0 and the standstill current I_0 have to be reduced by 30% after 2 seconds. In case of applications which require a longer holding of M_0 , we recommend the drive to be held via the holding brake and reduce the current, e.g. by controller inhibit.
- In case of servo inverters, the switching frequency dependent overload capacity is considered in the default setting. For more information, see the servo inverter catalogue.

	n_k
	[r/min]
MCM	75.0

MCM synchronous servo motors

General information



Dimensioning

Influence of ambient temperature and site altitude

The information relating to the servo motors in the tables and graphs is valid for a maximum ambient temperature (T_{opr}) of 40 °C and a site altitude (H) up to 1000 m above sea level. The torque correction factor (k_{M1}) shall be applied to the S1 torque characteristic ($M_0...M_N$) in the event of differing installation conditions.

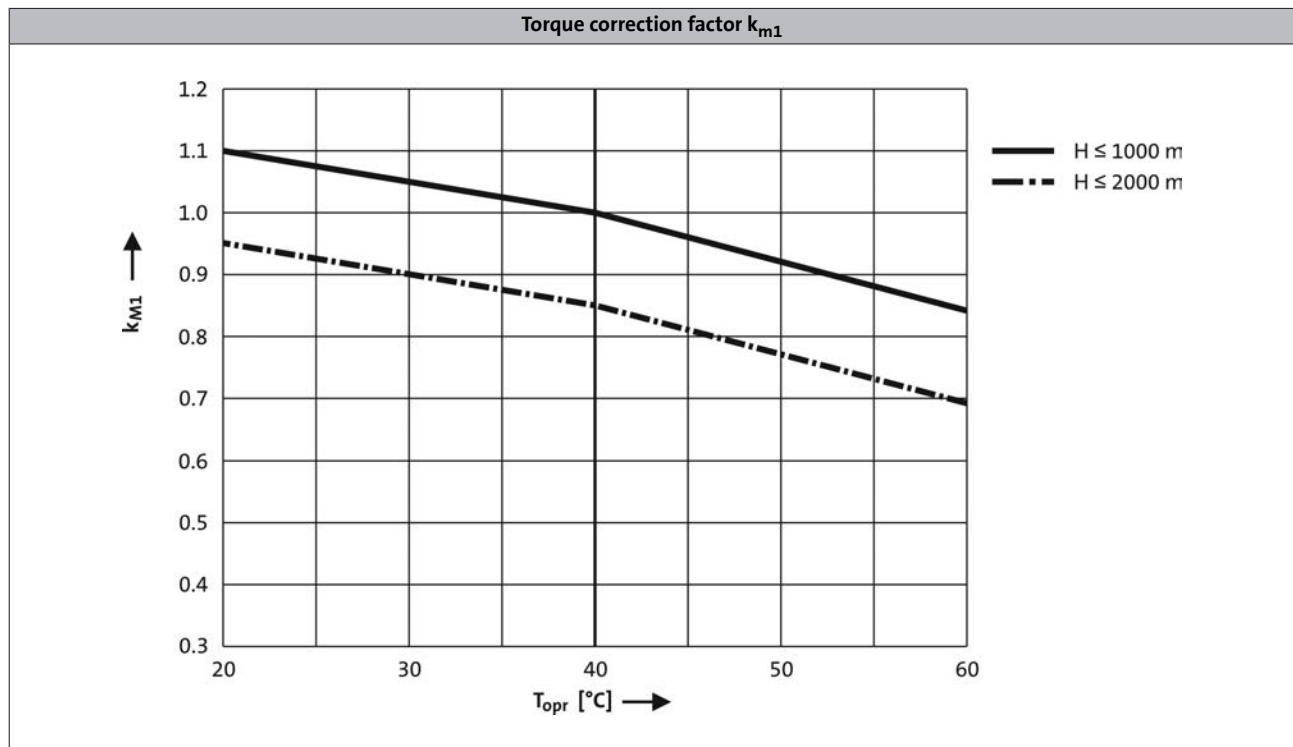

MCM synchronous servo motors

Technical data



Standards and operating conditions

			MCM
Cooling type			Naturally ventilated
Degree of protection			IP54 ¹⁾
EN 60529			
Temperature class			F
IEC/EN 60034-1; utilisation			F
IEC/EN 60034-1; insulation system (enamel-insulated wire)			F
Conformity			Low-Voltage Directive
CE			2006/95/EC
Approval			CSA 22.2 No. 100
CSA			UL 1004-1
cURus			UL 1004-6
			Power Conversion Equipment (File-No. E210321)
Max. voltage load			Pulse voltage limiting curve A
IEC/TS 60034-25			
Smooth running			Normal class
IEC 60072			
Axial run-out			Normal class
IEC 60072			
Concentricity			Normal class
IEC 60072			
Mechanical ambient conditions (vibration)			3M6
IEC/EN 60721-3-3			
Min. ambient operating temperature			
Without brake	$T_{opr,min}$	[°C]	-15
With brake	$T_{opr,min}$	[°C]	-10
Max. ambient operating temperature			
	$T_{opr,max}$	[°C]	40
Max. surface temperature			
	T	[°C]	140
Mechanical tolerance			
Flange centring diameter			$b_2 \leq 230 \text{ mm} = j6$ $b_2 > 230 \text{ mm} = h6$
Shaft diameter			$d \leq 50 \text{ mm} = k6$ $d > 50 \text{ mm} = m6$
Site altitude			
Amsl	H_{max}	[m]	2000

¹⁾ IP65 housing

MCM synchronous servo motors

Technical data



Permissible radial and axial forces

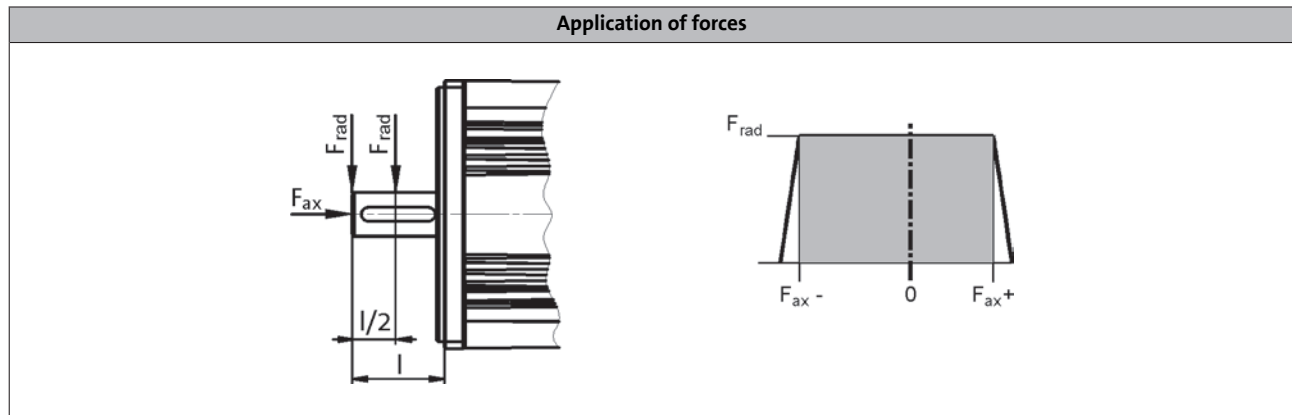

Application of force at $l/2$

Bearing service life L_{10}			
			20000 h
	F_{rad} [N]	$F_{ax,-}$ [N]	$F_{ax,+}$ [N]
MCM06	245	98	98
MCM09	392	147	147
MCM12	490	196	196

Application of force at l

Bearing service life L_{10}			
			20000 h
	F_{rad} [N]	$F_{ax,-}$ [N]	$F_{ax,+}$ [N]
MCM06	196	98	98
MCM09	294	147	147
MCM12		196	196

- The values for the bearing service life L_{10} refer to an average speed of 4000 r/min. Depending on the ambient temperatures, the service life of the bearings is also reduced by the grease life-time.

MCM synchronous servo motors

Technical data



Rated data, non-ventilated

► The data applies to a mains connection voltage of 3 x 400 V.

	n_N [r/min]	M_0 [Nm]	M_N [Nm]	M_{max} [Nm]	P_N [kW]	I_0 [A]	I_N [A]	I_{max} [A]	$U_{N, AC}$ [V]	f_N [Hz]
MCM06C30-	3000	0.70	0.60	1.80	0.19	1.00	0.90	2.50	183	200
MCM06E30-	3000	1.40	1.20	3.10	0.38	1.20	1.10	2.60	273	200
MCM09C30-	3000	1.50	1.30	3.50	0.40	1.10	1.10	2.60	300	200
MCM09E30-	3000	2.90	2.40	6.50	0.75	2.10	1.90	4.80	296	200
MCM12C30-	3000	2.90	2.40	6.50	0.75	2.10	1.80	4.80	283	250
MCM12F30-	3000	5.50	4.80	14.1	1.50	3.80	3.50	10.0	291	250
MCM12J30-	3000	9.60	8.00	26.4	2.50	6.80	5.80	19.0	274	250

	$\eta_{100\%}$ [%]	$J^1)$ [kgcm ²]	$KE_{LL 150\text{ °C}}$ [V/(1000 r/min)]	$R_{UV 20\text{ °C}}$ [Ω]	$R_{UV 150\text{ °C}}$ [Ω]	L_N [mH]	$Kt_{0 150\text{ °C}}$ [Nm/A]	$n_{max}^2)$ [r/min]	$m^1)$ [kg]
MCM06C30-	68.1	0.19	45.0	27.6	41.6	25.0	0.70	6000	1.40
MCM06E30-	77.5	0.34	71.6	26.8	40.4	30.0	1.17	6000	1.80
MCM09C30-	79.0	0.61	82.5	20.0	30.1	31.0	1.36	6000	2.30
MCM09E30-	84.9	0.88	80.0	11.2	16.9	19.0	1.38	6000	2.80
MCM12C30-	91.3	1.54	78.8	6.68	10.1	18.0	1.38	5000	3.40
MCM12F30-	93.0	2.80	83.6	3.04	4.58	9.60	1.45	5000	4.80
MCM12J30-	94.3	4.49	81.4	1.55	2.34	5.30	1.41	5000	6.70

¹⁾ Without brake.

²⁾ Mechanically permissible maximum speed.

MCM synchronous servo motors

Technical data



Selection tables, Servo-Inverter i700

Non-ventilated motors

- The data applies to a mains connection voltage of 3 x 400 V and an inverter switching frequency of 4 kHz.

					E70ACM	S□0054	S□0104	S□0204
					I _N	2.5	5.0	10.0
					I _{0,max}	5.0	10.0	20.0
MCM	M _N	n _N	I _N	P _N	I _{max}	5.0	10.0	20.0
06C30	0.6	3000	0.9	0.19	M ₀	0.7		
					M _N	0.6		
					M _{0,max}	1.8		
					M _{max}	1.8		
					η _{eto}	-		
06E30	1.2	3000	1.1	0.38	M ₀	1.4		
					M _N	1.2		
					M _{0,max}	3.1		
					M _{max}	3.1		
					η _{eto}	-		
09C30	1.3	3000	1.1	0.40	M ₀	1.5		
					M _N	1.3		
					M _{0,max}	3.5		
					M _{max}	3.5		
					η _{eto}	-		
09E30	2.4	3000	1.9	0.75	M ₀	2.9		
					M _N	2.4		
					M _{0,max}	6.5		
					M _{max}	6.5		
					η _{eto}	-		
12C30	2.4	3000	1.8	0.75	M ₀	2.9		
					M _N	2.4		
					M _{0,max}	6.5		
					M _{max}	6.5		
					η _{eto}	-		
12F30	4.8	3000	3.5	1.50	M ₀		5.5	
					M _N		4.8	
					M _{0,max}		14.1	
					M _{max}		14.1	
					η _{eto}		-	
12J30	8.0	3000	5.8	2.50	M ₀			9.6
					M _N			8.0
					M _{0,max}			26.4
					M _{max}			26.4
					η _{eto}			-

- I... [A], M... [Nm], n... [r/min], P... [kW]

MCM synchronous servo motors

Technical data



Selection tables, Servo Drives 9400 HighLine

Non-ventilated motors

- The data applies to a mains connection voltage of 3 x 400 V and an inverter switching frequency of 4 kHz.

					E94A□□	E0024	E0034	E0044	E0074	E0094	E0134
					I_N	1.9	3.1	5.0	8.8	11.7	16.3
					$I_{0,max}$	6.0	10.0	16.0	21.0	28.0	39.0
MCM	M_N	n_N	I_N	P_N	I_{max}	6.0	10.0	16.0	21.0	28.0	39.0
06C30	0.6	3000	0.9	0.19	M_0	0.7					
					M_N	0.6					
					$M_{0,max}$	1.8					
					M_{max}	1.8					
					η_{eto}	-					
06E30	1.2	3000	1.1	0.38	M_0	1.4					
					M_N	1.2					
					$M_{0,max}$	3.1					
					M_{max}	3.1					
					η_{eto}	-					
09C30	1.3	3000	1.1	0.40	M_0	1.5					
					M_N	1.3					
					$M_{0,max}$	3.5					
					M_{max}	3.5					
					η_{eto}	-					
09E30	2.4	3000	1.9	0.75	M_0	2.6	2.9				
					M_N	2.4	2.4				
					$M_{0,max}$	5.4	6.5				
					M_{max}	6.5	6.5				
					η_{eto}	-	-				
12C30	2.4	3000	1.8	0.75	M_0	2.6	2.9				
					M_N	2.4	2.4				
					$M_{0,max}$	5.4	6.5				
					M_{max}	6.5	6.5				
					η_{eto}	-	-				
12F30	4.8	3000	3.5	1.50	M_0			5.5			
					M_N			4.8			
					$M_{0,max}$			14.1			
					M_{max}			14.1			
					η_{eto}			-			
12J30	8.0	3000	5.8	2.50	M_0				9.6	9.6	9.6
					M_N				8.0	8.0	8.0
					$M_{0,max}$				19.3	25.7	26.4
					M_{max}				26.4	26.4	26.4
					η_{eto}				-	-	-

- I... [A], M... [Nm], n... [r/min], P... [kW]

MCM synchronous servo motors

Technical data



Selection tables, Inverter Drives 8400 TopLine

Non-ventilated motors

- The data applies to a mains connection voltage of 3 x 400 V and an inverter switching frequency of 8 kHz.

					E84AVTC	□3714	□7514	□1524	□2224	□3024	□4024	□5524
					I_N	1.3	2.4	3.9	5.9	7.3	9.5	13.0
					$I_{0,max}$	2.0	3.6	5.9	8.4	11.0	14.3	19.5
MCM	M_N	n_N	I_N	P_N	I_{max}	2.6	4.8	7.8	11.2	14.6	19.0	26.0
06C30	0.6	3000	0.9	0.19	M_0	0.7						
					M_N	0.6						
					$M_{0,max}$	1.8						
					M_{max}	1.8						
					η_{eto}	-						
06E30	1.2	3000	1.1	0.38	M_0	1.4						
					M_N	1.2						
					$M_{0,max}$	3.1						
					M_{max}	3.1						
					η_{eto}	-						
09C30	1.3	3000	1.1	0.40	M_0	1.5						
					M_N	1.3						
					$M_{0,max}$	3.5						
					M_{max}	3.5						
					η_{eto}	-						
09E30	2.4	3000	1.9	0.75	M_0		2.9					
					M_N		2.4					
					$M_{0,max}$		6.5					
					M_{max}		6.5					
					η_{eto}		-					
12C30	2.4	3000	1.8	0.75	M_0		2.9					
					M_N		2.4					
					$M_{0,max}$		6.5					
					M_{max}		6.5					
					η_{eto}		-					
12F30	4.8	3000	3.5	1.50	M_0			5.5	5.5	5.5		
					M_N			4.8	4.8	4.8		
					$M_{0,max}$			8.4	11.8	14.1		
					M_{max}			11.1	14.1	14.1		
					η_{eto}			-	-	-		
12J30	8.0	3000	5.8	2.50	M_0					9.6	9.6	9.6
					M_N					8.0	8.0	8.0
					$M_{0,max}$					15.4	19.9	26.4
					M_{max}					20.4	26.4	26.4
					η_{eto}					-	-	-

- I... [A], M... [Nm], n... [r/min], P... [kW]

MCM synchronous servo motors

Technical data



Torque characteristics

► The data applies to a mains connection voltage of 3 x 400 V.

MCM06C30-

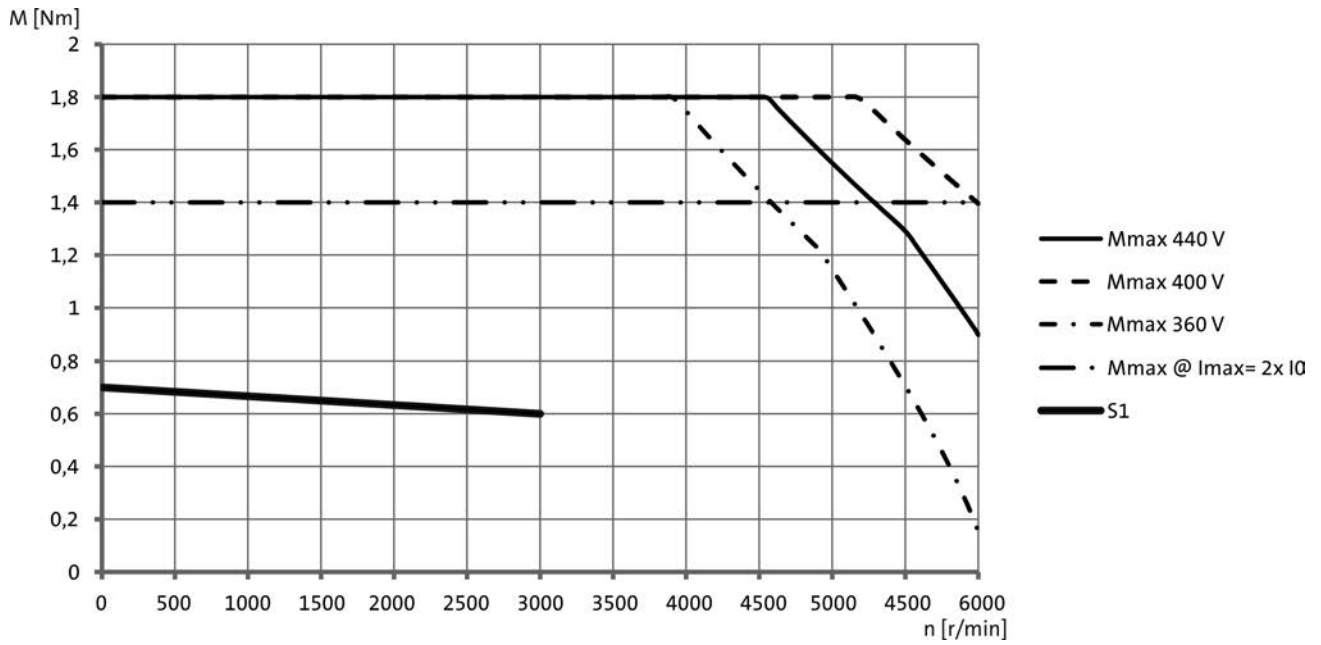

MCM06F30-

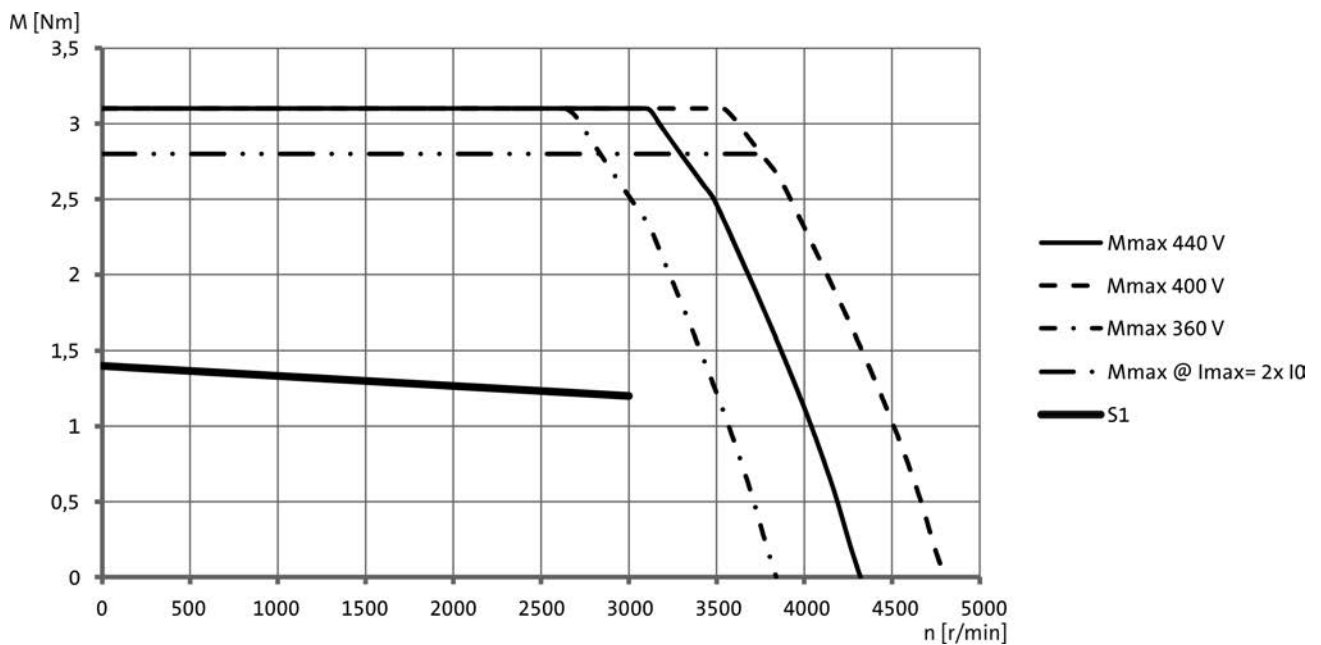

5.2

MCM synchronous servo motors

Technical data



Torque characteristics

► The data applies to a mains connection voltage of 3 x 400 V.

MCM09C30-

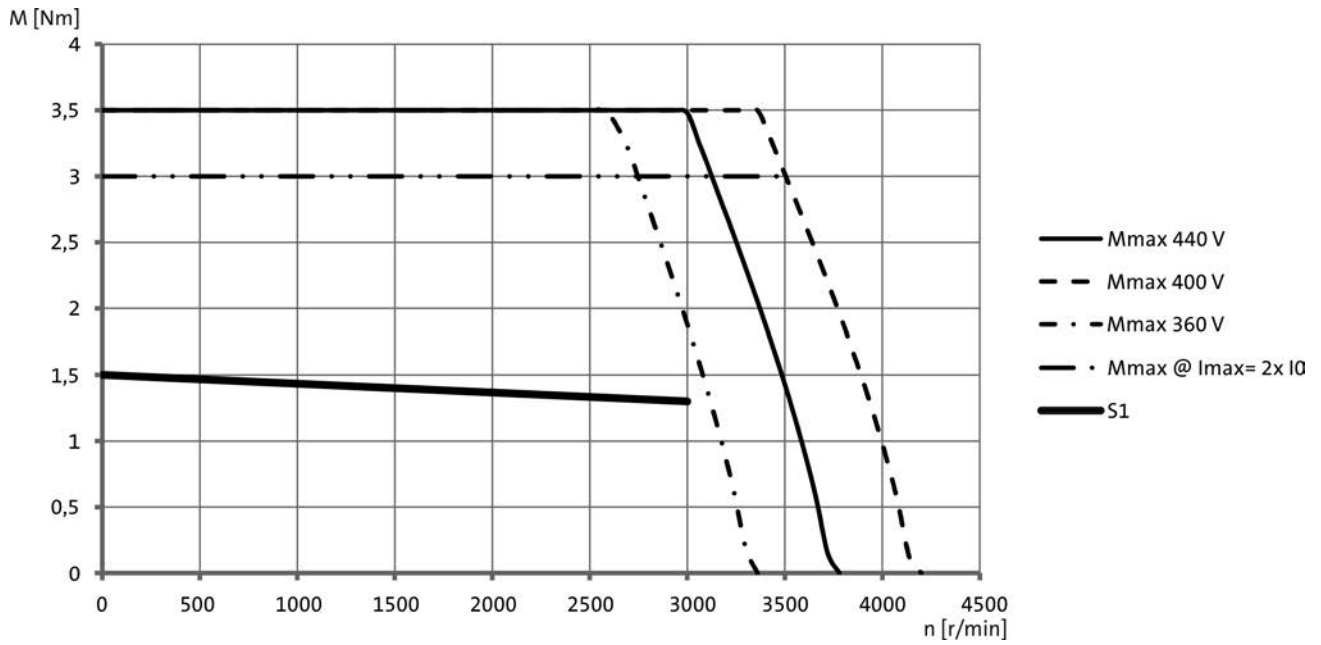

5.2

MCM09F30-

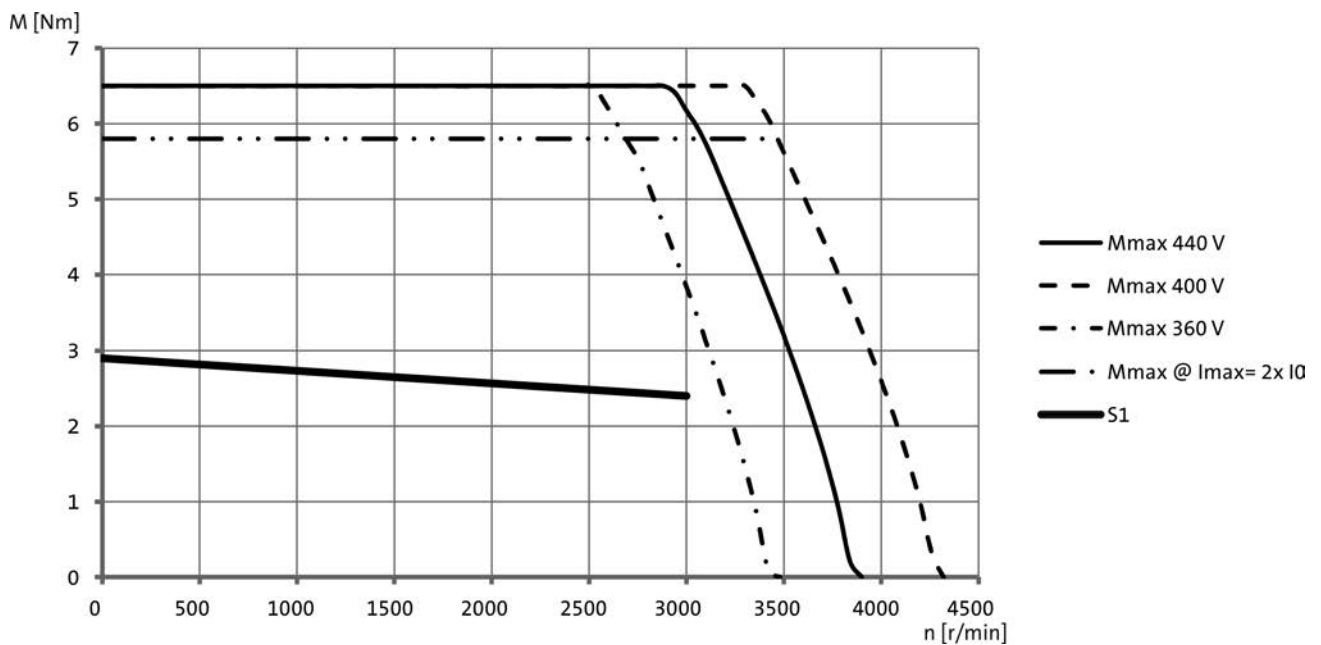

MCM synchronous servo motors

Technical data



Torque characteristics

► The data applies to a mains connection voltage of 3 x 400 V.

MCM12C30-

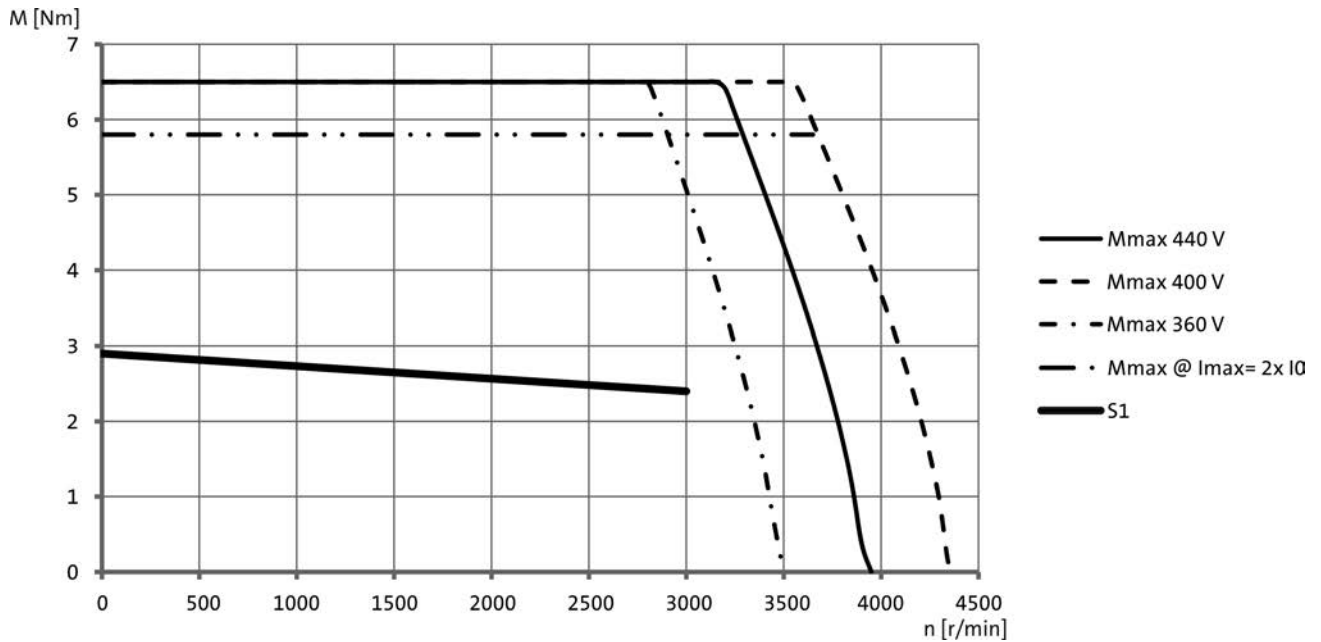

MCM12F30-

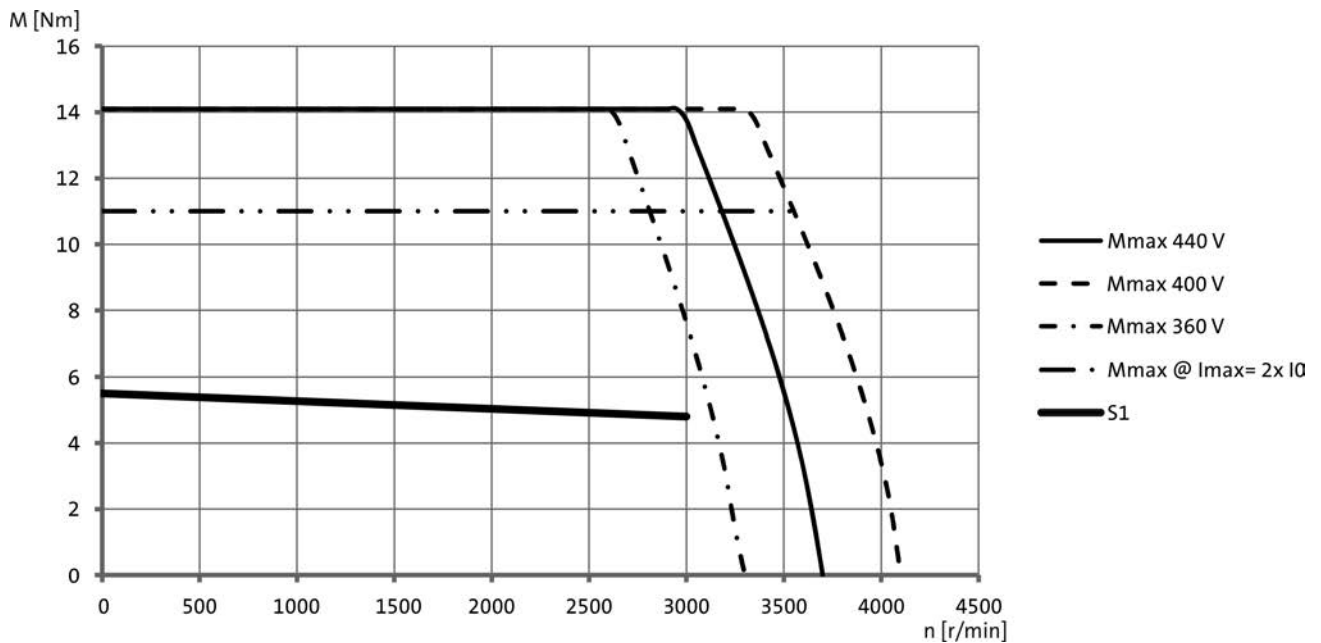

5.2

MCM synchronous servo motors

Technical data



Torque characteristics

► The data applies to a mains connection voltage of 3 x 400 V.

MCM12J30-

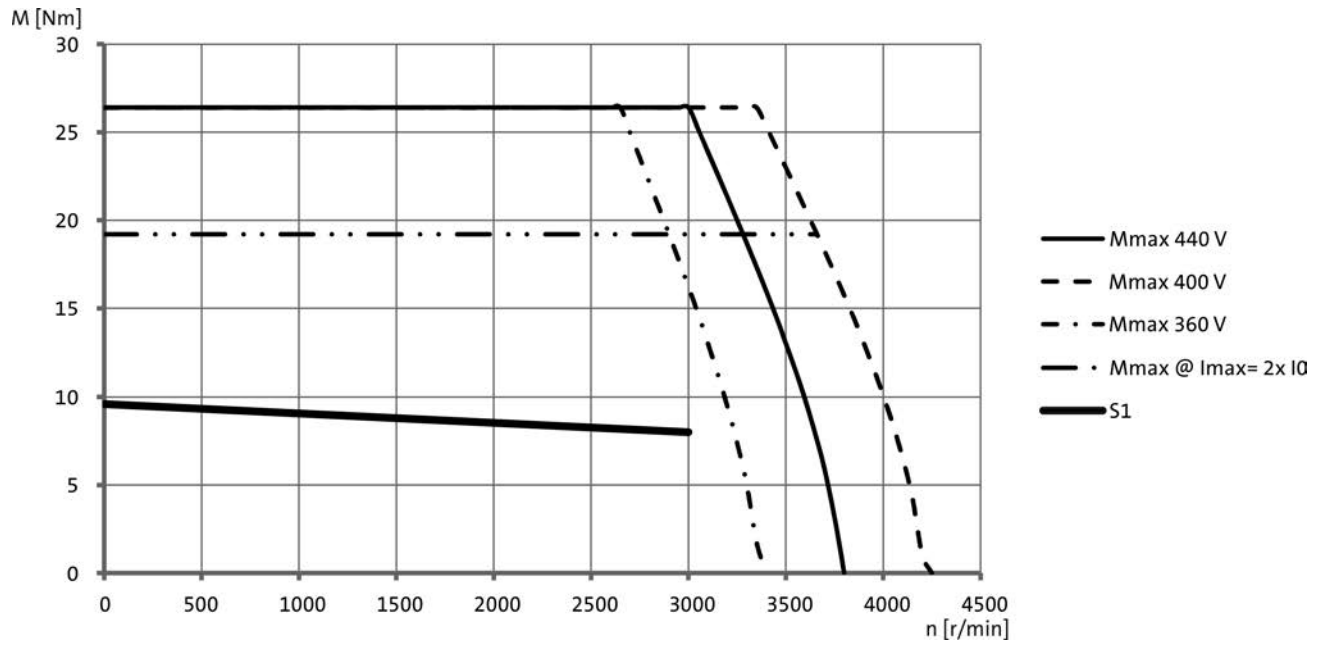

MCM synchronous servo motors

Technical data



Dimensions, self-ventilated

MCM06

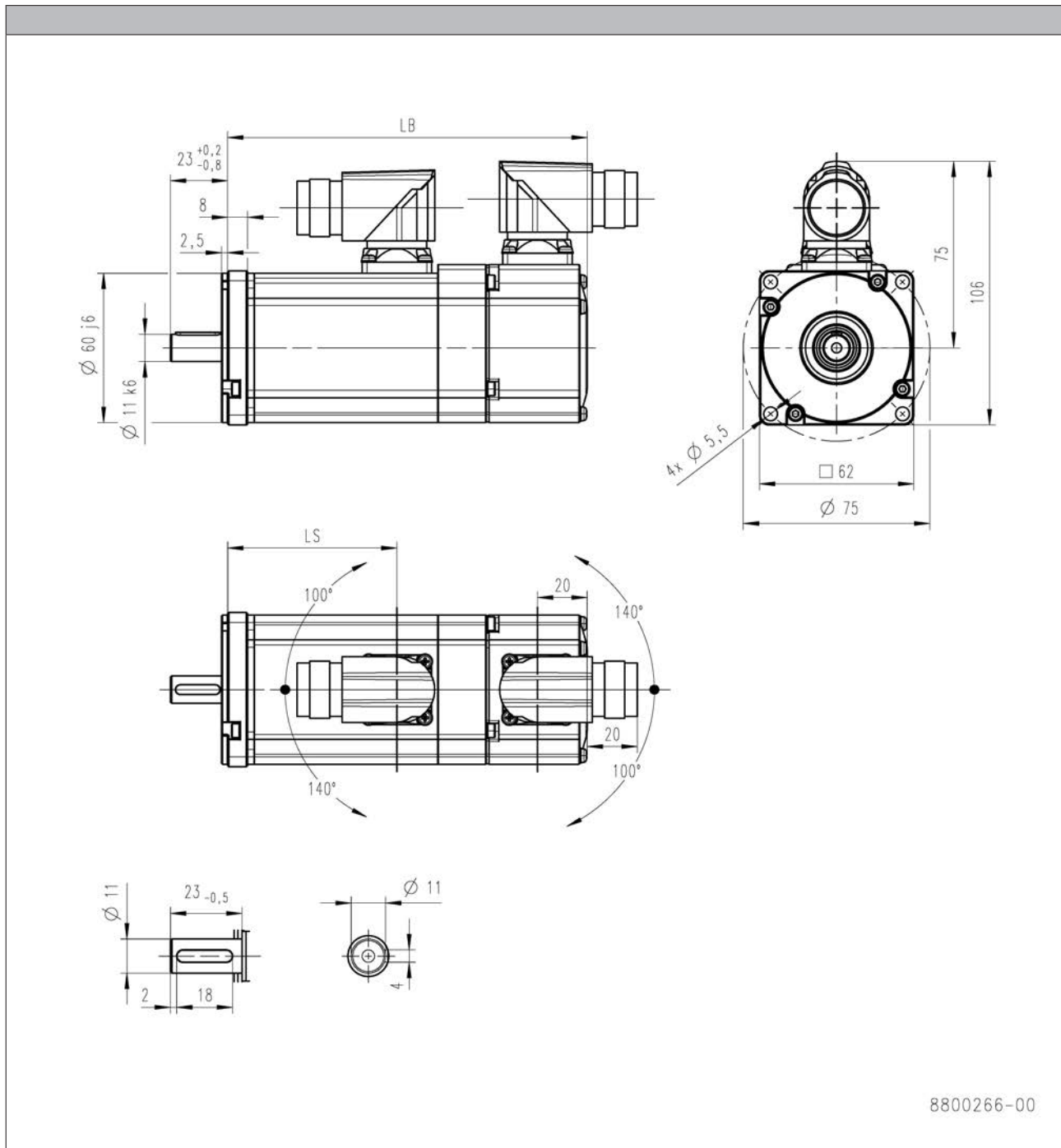

5.2

			MCM06C	MCM06E
RS0/SKM B0	LB	[mm]	146	171
RS0/SKM F1	LB	[mm]	182	207
	LS	[mm]	69.0	94.0

- ▶ Speed / angle sensor: R□□ / C□□ / S□□ / E□□
- ▶ Brake: B0 / F1 / F2

MCM synchronous servo motors

Technical data



Dimensions, self-ventilated

MCM09

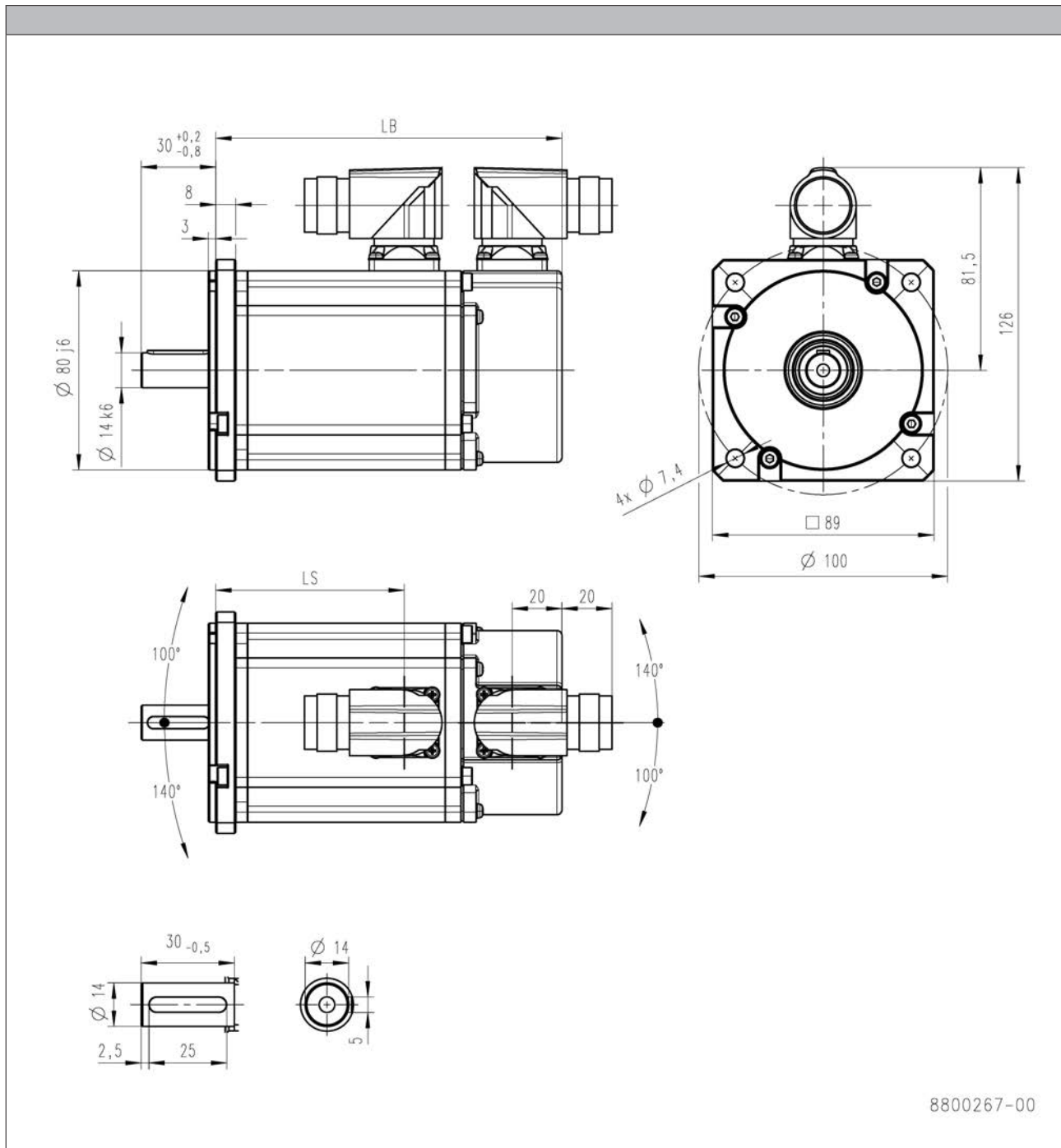

5.2

			MCM09C	MCM09E
RS0/SKM B0	LB	[mm]	140	155
RS0/SKM F1	LB	[mm]	176	191
	LS	[mm]	76.5	91.5

- ▶ Speed / angle sensor: R□□ / C□□ / S□□ / E□□
- ▶ Brake: B0 / F1 / F2

MCM synchronous servo motors

Technical data



Dimensions, self-ventilated

MCM12

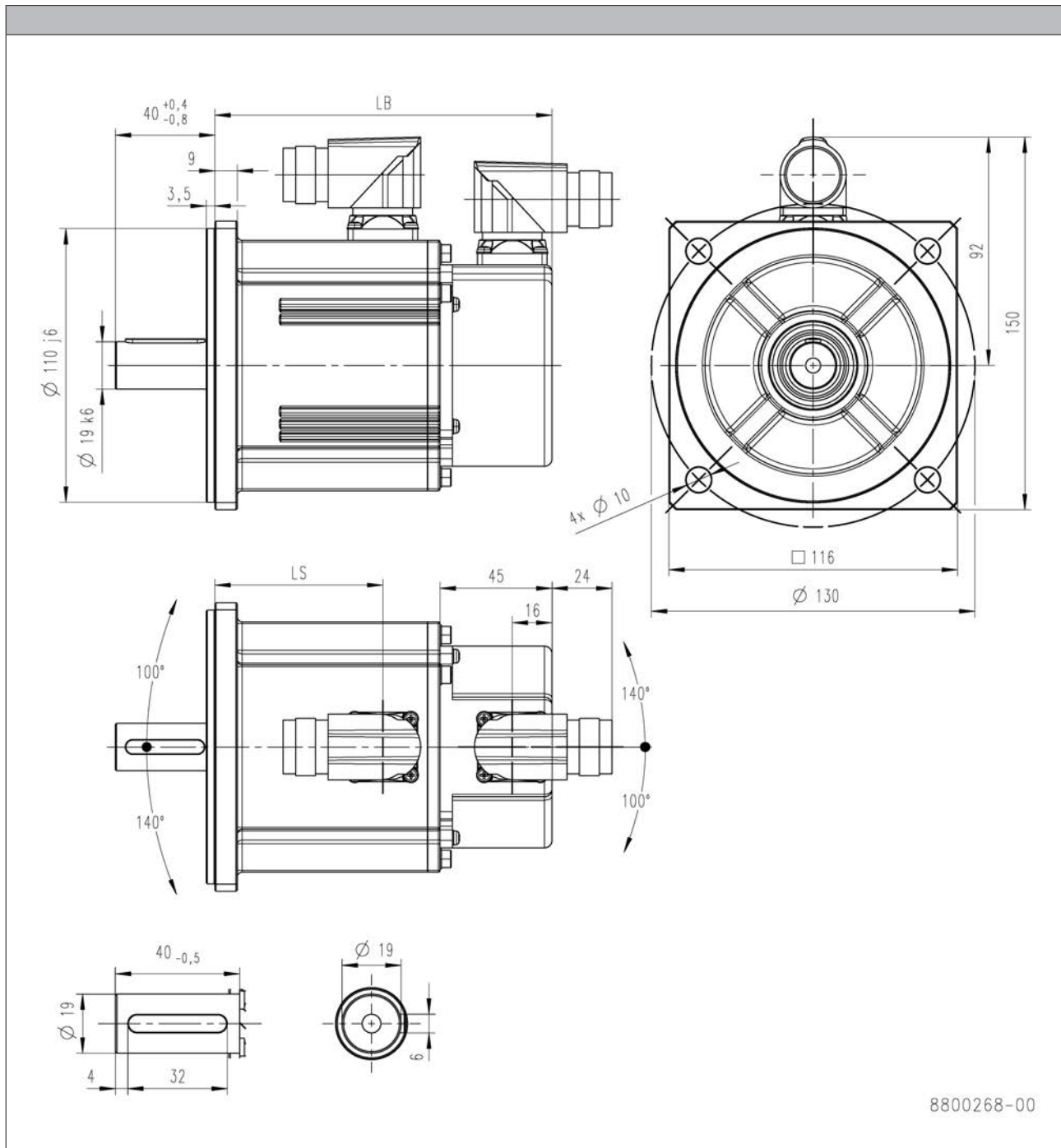

5.2

			MCM12C	MCM12F	MCM12J
RS0/SKM B0	LB	[mm]	136	164	201
RS0/SKM F1	LB	[mm]	178	206	243
	LS	[mm]	68.0	96.0	133

- ▶ Speed / angle sensor: R□□ / C□□ / S□□ / E□□
- ▶ Brake: B0 / F1 / F2

MCM synchronous servo motors

Technical data



MCM synchronous servo motors

Accessories



Spring-applied holding brake

Spring-operated holding brakes are available for the MCM synchronous servo motors.

The brakes are activated when the supply voltage is disconnected (closed-circuit principle). When using the brakes purely as holding brakes, virtually no wear occurs on the friction surfaces.

Caution:

The brakes used are not safety brakes in the sense that a reduction in torque may arise as a result of disruptive factors that cannot be influenced, e.g. oil ingress.

The ohmic voltage drop along the cable must be taken into consideration in long motor supply cables and must be compensated for by a higher voltage at the line input.

The following applies for Lenze system cables:

$$U[V] = U_B[V] + 0.08 \frac{[V]}{[A] \cdot [m]} \cdot l_{lg}[m] \cdot I_B[A]$$

If no suitable voltage (incorrect value, incorrect polarity) is applied to the brake, the brake will be applied and can be overheated and destroyed by the motor continuing to rotate.

The shortest switching times of the brakes are achieved by DC switching of the voltage. A spark suppressor is required to suppress interference and to increase the service life of the relay contacts here.



Spring-applied holding brake

MCM synchronous servo motors

Accessories



Spring-applied holding brake

Rated data

	$U_{N,DC}^{3,5)}$	M_N 20 °C	M_N 120 °C	M_{av} 120 °C	$I_N^{2)}$	J	$t_1^{1)}$	$t_2^{1)}$	$Q_E^{4)}$	m
	[V]	[Nm]	[Nm]	[Nm]	[A]	[kgcm ²]	[ms]	[ms]	[J]	[kg]
MCM06C30-	24	1.35	1.30	0.82	0.36	0.018	15.0	50.0	30000	0.30
MCM06E30-										
MCM09C30-										
MCM09E30-		2.90	2.50	1.57	0.42	0.075	20.0	70.0	115000	0.50
MCM12C30-		8.00	7.00	5.00	0.81	0.17	15.0	50.0	490000	0.75
MCM12F30-										
MCM12J30-		12.0	11.0	7.70				80.0		

¹⁾ Engagement and disengagement times are valid for rated voltage ($\pm 0\%$) and protective circuit for brakes with varistor for DC switching. The times may increase without a protective circuit.

²⁾ The currents are the maximum values when the brake is cold (value used for dimensioning the current supply). The values for a motor at operating temperature are considerably lower.

³⁾ With 24V DC brake: smoothed DC voltage, ripple $\leq 1\%$.

⁴⁾ Maximum switching energy per emergency stop at $n = 3000$ r/min for at least 2000 emergency stops.

⁵⁾ Voltage tolerance:

MCM06/09 $\pm 5\%$

MCM12 $\pm 10\%$

MCM synchronous servo motors



Accessories



Resolver

Stator-fed resolver with two stator windings offset by 90° and one rotor winding with transformer winding.



Speed/angle sensor				
	1)			RS0
Product key				RS0
Resolution				
Angle			[°]	0.80
Accuracy				
			[°]	-10 ... 10
Absolute positioning				
				1 revolution
Max. speed				
	n_{max}		[r/min]	8000
Max. input voltage				
DC	$U_{in,max}$		[V]	10.0
Max. input frequency				
	$f_{in,max}$		[kHz]	4.00
Ratio				
Stator / rotor		$\pm 5\%$		0.30
Rotor impedance				
	Z_{r0}		[Ω]	51 + j90
Stator impedance				
	Z_{s0}		[Ω]	102 + j150
Impedance				
	Z_{rs}		[Ω]	44 + j76
Min. insulation resistance				
At DC 500 V	R		[MΩ]	10.0
Number of pole pairs				
				1
Max. angle error				
			[°]	-10 ... 10
Inverter assignment				
				i700 E84AVTC E94A ECS EVS93

¹⁾   6 - Product key > speed/angle sensor



SinCos absolute value encoder

Encoder type			SinCos absolute value
Speed/angle sensor			SKM
Product key			AM128-8V-H
Encoder type			Multi-turn
Pulses			128
Output signals			1 Vss
Interfaces			Hiperface
Absolute revolutions			4096
Resolution			
Angle		[°]	0.40
Accuracy			
		[°]	-1.3 ... 1.3
Min. input voltage			
DC	$U_{in,min}$	[V]	7.00
Max. input voltage			
DC	$U_{in,max}$	[V]	12.0
Max. speed			
	n_{max}	[r/min]	9000
Max. current consumption			
	I_{max}	[A]	0.060
Limit frequency			
	f_{max}	[kHz]	200
Inverter assignment			
			i700 E84AVTC E94A ECS EVS93

¹⁾   6 - Product key > speed/angle sensor



Temperature monitoring

The KTY 83-110 thermal sensor used in the MCM motors continuously monitors the motor temperature. The temperature information is transmitted to the servo inverter by means of the system cable of the feedback system.

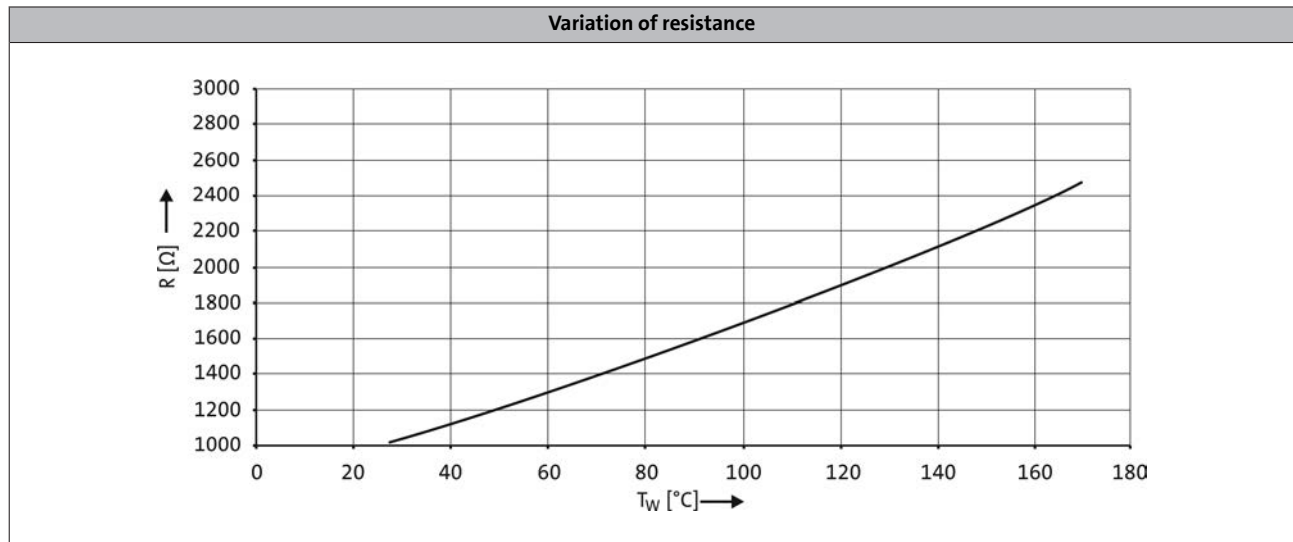

- If the thermal sensor is supplied with a measurement current of 1 mA, the above relationship between the temperature and the resistance applies.

MCM synchronous servo motors



Accessories

ICN connector

An ICN connector is used as standard for the electrical connection to the servo motors.

A connector is used for the connection of motor and brake. The connections to the feedback system/temperature monitoring and the blower each employ a separate connector.

The connectors can be rotated through 270° and are fitted with a bayonet catch for SpeedTec connectors. As the connector fixing is also compatible with conventional union nuts. Existing mating connectors can therefore still be used without difficulty.

Connection for power and brake

Pin assignment		
Contact	Designation	Meaning
1	BD1	Holding brake +
2	BD2	Holding brake -
PE	PE	PE conductor
4	U	Phase U power
5	V	Phase V power
6	W	Phase W power

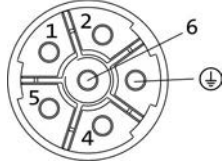

MCM synchronous servo motors

Accessories



ICN connector

Feedback connection

► Resolver

Pin assignment		
Contact	Designation	Meaning
1	+Ref	Transformer windings
2	-Ref	
3	+VCC ETS	Supply: Electronic nameplate
4	+COS	Cosine stator windings
5	-COS	
6	+SIN	Sine stator windings
7	-SIN	
8		Not assigned
9		
10		
11	+KTY	KTY temperature sensor
12	-KTY	

► Hiperface SinCos absolute value encoder

Pin assignment		
Contact	Designation	Meaning
1	B	Track B/+SIN
2	A ⁻	Track A inverse/-COS
3	A	Track A/+COS
4	+U _B	Supply +
5	GND	Mass
6	Z ⁻	Zero track inverse/-RS485
7	Z	Zero track/+RS485
8		Not assigned
9	B ⁻	Track B inverse/-SIN
10		Not assigned
11	+KTY	KTY temperature sensor
12	-KTY	

MCM synchronous servo motors

Accessories



MCM synchronous servo motors

Accessories



MCM synchronous servo motors

Accessories



Motors

MD□KS synchronous servo motors

2.8 to 52 Nm

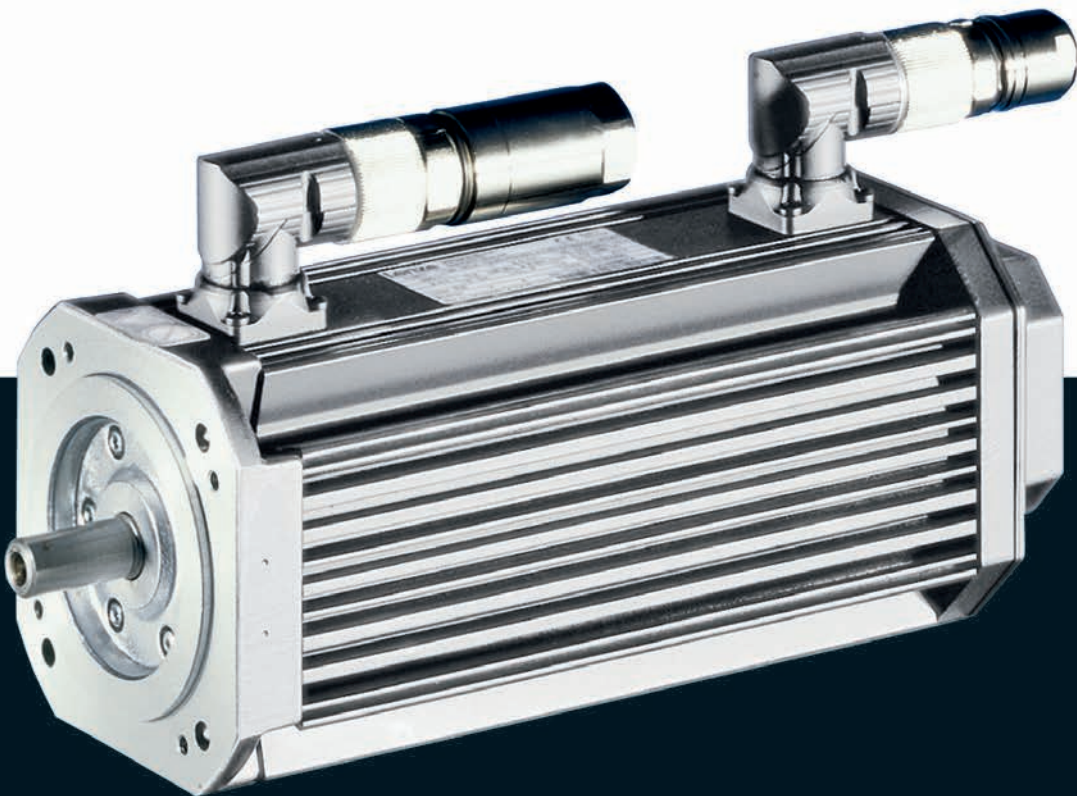

MD□KS synchronous servo motors



Contents

General information	List of abbreviations	5.3 - 4
	Product key	5.3 - 6
	Product information	5.3 - 7
	Functions and features	5.3 - 8
	Dimensioning	5.3 - 9
Technical data	Standards and operating conditions	5.3 - 15
	Permissible radial and axial forces	5.3 - 16
	Rated data, non-ventilated	5.3 - 17
	Rated data, forced ventilated	5.3 - 17
	Selection tables, Servo Drives 9400 HighLine	5.3 - 18
	Selection tables, Inverter Drives 8400 TopLine	5.3 - 20
	Selection tables, Servo Drives ECS	5.3 - 22
	Selection tables, Servo Inverter 9300	5.3 - 24
	Torque characteristics	5.3 - 26
	Dimensions, self-ventilated	5.3 - 30
	Dimensions, forced ventilated	5.3 - 32
	Accessories	Permanent magnet holding brake
Resolver		5.3 - 38
Incremental encoder and SinCos absolute value encoder		5.3 - 39
Blower		5.3 - 40
Temperature monitoring		5.3 - 41
Terminal box		5.3 - 42
ICN connector	5.3 - 44	



List of abbreviations

$\eta_{100\%}$	[%]	Efficiency
$\cos \phi$		Power factor
du/dt	[kV/ μ s]	Insulation resistance
$F_{ax,-}$	[N]	Min. axial force
$F_{ax,+}$	[N]	Max. axial force
$f_{in,max}$	[Hz]	Max. input frequency
f_{max}	[kHz]	Limit frequency
f_{max}	[kHz]	Max. switching frequency
f_N	[Hz]	Rated frequency
F_{rad}	[N]	Max. radial force
H_{max}	[m]	Site altitude
I_0	[A]	Standstill current
I_{max}	[A]	Max. short-time DC-bus current
I_{max}	[A]	Max. current
I_{max}	[A]	Max. current consumption
I_{max}	[A]	Max. current
I_{max}	[A]	Max. DC-bus current
I_N	[A]	Rated current
J	[kgcm ²]	Moment of inertia
J_{MB}	[kgcm ²]	Moment of inertia
$KE_{LL\ 150\ ^\circ C}$	[V / (1000 r/min)]	Voltage constant
$Kt_{0\ 150\ ^\circ C}$	[Nm/A]	Torque constant
L	[mH]	Mutual inductance
$L_{1\sigma}$	[mH]	Stator leakage inductance
$L_{2\sigma}$	[mH]	Rotor leakage inductance
L_N	[mH]	Rated inductance
m	[kg]	Mass
M_0	[Nm]	Stall torque
$M_{0,max}$	[Nm]	Max. standstill torque
M_{av}	[Nm]	Average dynamic torque
M_{max}	[Nm]	Max. torque
M_N	[Nm]	Rated torque
n_{eto}	[r/min]	Transition speed
n_k	[r/min]	Speed
n_{max}	[r/min]	Max. speed

n_N	[r/min]	Rated speed
P_N	[kW]	Rated power
Q_E	[J]	Maximum switching energy
R	[Ω]	Insulation resistance
R	[Ω]	Min. insulation resistance
R_1	[Ω]	Stator impedance
R_2	[Ω]	Charging resistor
R_2	[Ω]	Rotor impedance
$R_{UV\ 150\ ^\circ C}$	[Ω]	Stator impedance
$R_{UV\ 20\ ^\circ C}$	[Ω]	Stator impedance
$S_{h\u00fc}$	[1/h]	Transition operating frequency
T	[$^\circ C$]	Operating temperature
T	[$^\circ C$]	Rated temperature
T	[$^\circ C$]	Max. ambient temperature of bearing
T	[$^\circ C$]	Max. surface temperature
T	[$^\circ C$]	Max. ambient temperature for transport
T	[$^\circ C$]	Min. ambient storage temperature
T	[$^\circ C$]	Min. ambient temperature for transport
T	[$^\circ C$]	Ambient temperature
t_1	[ms]	Engagement time
t_2	[ms]	Disengagement time
$T_{opr,max}$	[$^\circ C$]	Max. ambient operating temperature
$T_{opr,min}$	[$^\circ C$]	Min. ambient operating temperature
$U_{in,max}$	[V]	Max. input voltage
$U_{in,min}$	[V]	Min. input voltage
U_{max}	[V]	Max. mains voltage
U_{max}	[V]	Min. input voltage
U_{min}	[V]	Min. mains voltage
$U_{N, AC}$	[V]	Rated voltage
$U_{N, DC}$	[V]	Rated voltage
Z_{ro}	[Ω]	Rotor impedance
Z_{rs}	[Ω]	Impedance
Z_{so}	[Ω]	Stator impedance

MD□KS synchronous servo motors

General information



List of abbreviations

CE	Communauté Européenne
CSA	Canadian Standards Association
DIN	Deutsches Institut für Normung e.V.
EMC	Electromagnetic compatibility
EN	European standard
EAC	Customs union Russia / Belarus / Kazakhstan certificate
IEC	International Electrotechnical Commission
IM	International Mounting Code
IP	International Protection Code
NEMA	National Electrical Manufacturers Association
UkrSEPRO	Certificate for Ukraine
UL	Underwriters Laboratory Listed Product
UR	Underwriters Laboratory Recognized Product
VDE	Verband deutscher Elektrotechniker (Association of German Electrical Engineers)

MD□KS synchronous servo motors

General information



Product key

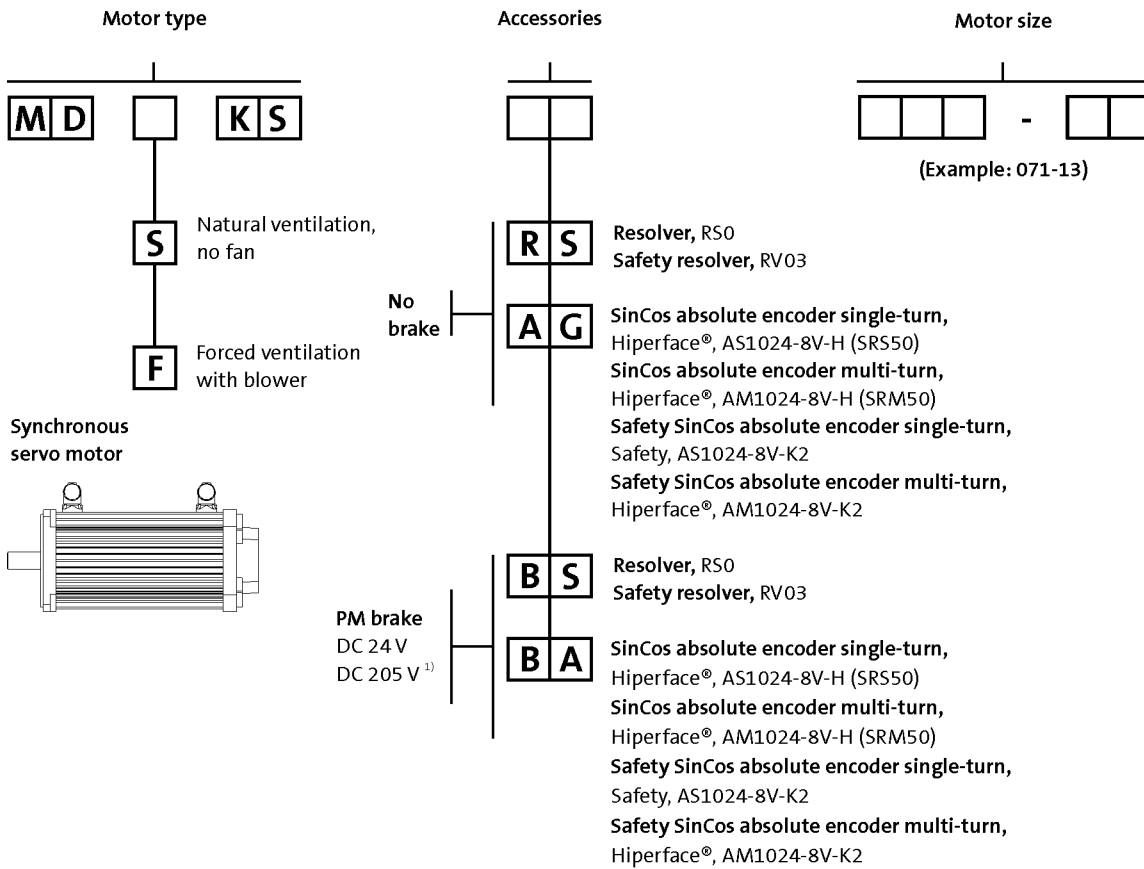

5.3

¹⁾ Not possible for UL design.

Ordering details checklist	
Product key	MDSKS... / MDFKS...
Built-on accessories: brake	Without/24 V DC/205 V DC
Motor design	B14 / B5 design
Shaft design	with/without keyway
Enclosure	IP54 / IP65
Motor connection	Circular connector / terminal box...
Colour	RAL 9005 (jet black) / RAL...

8 - Servo motor designs

MD□KS synchronous servo motors

General information



Product information

An application-oriented structure, low moments of inertia, compact dimensions and a high degree of intrinsic operational reliability characterise these robust and dynamic motors.

Whether naturally ventilated or with blower – in a power range from 1.1 kW to 5.9 kW these servo motors provide rated torque values from 2.8 Nm to 17 Nm with peak torques of up to 52 Nm.

High overload capacity and rapid angular acceleration ensure the best possible dynamic performance, while also guaranteeing excellent smooth running characteristics.

Continuous internal temperature measurement guarantees optimum control behaviour at all times, regardless of the temperature. A reinforced insulation system with thermal reserve (enamel-insulated wire in line with temperature class H, utilisation in line with F) ensures a long service life of the winding. Together with the IP54 protection, the prestressed roller bearings with high temperature-resistant grease guarantee long, maintenance-free operation. Thanks to the compact structure and modular motor concept, the MD□KS motors can be adapted for use with virtually any drive task.

Advantages

- High dynamic performance thanks to low moments of inertia
- Compact size with high power density
- Cooling with or without axial external fan
- Robust regenerative resolver system as standard
- Alternatively, sin/cos encoder for the highest precision
- Easy to install and service friendly thanks to use of SpeedTec connectors
- Optional terminal box
- Protection: IP54, IP65 optional for naturally ventilated motors
- GOST-certified, CE, RoHS-compliant, optionally available in UR
- High maximum speeds
- Wide speed setting range



MDSKA071 synchronous servo motor

MD□KS synchronous servo motors

General information



Functions and features

	MDSKS□□056	MDSKS□□071	MDFKS□□071
Design			
	B14-FT85 B5-FF100		B14-FT130 B5-FF130
Shaft end (with and without keyway)			
	14 x 30		19 x 40
A end shield	Not oil-tight		
Brake	DC 24 V AC 230 V ¹⁾ DC 205 V ¹⁾		
Permanent magnetic brake			
Speed and angle encoder	Resolver SinCos single-turn/multi-turn		
Cooling	Naturally ventilated		
Without blower			
Axial blower, 1 phase			230 V; 50 Hz
Temperature sensor	KTY		
Thermal detector			
Motor connection: plug connector	Power + brake Encoder + thermal sensor		Power + brake Encoder + thermal sensor Blower
Motor connection: terminal box	Power + brake Encoder + thermal sensor		Power + brake Encoder + thermal sensor + blower
Motor connection: Terminal box + plug connector			
Terminal box	Power + brake Encoder + thermal sensor		
Plug connector			Blower
Shaft bearings	Deep-groove ball bearing with high-temperature resistant grease, sealing disc or cover plate		
Bearing type			
Position of the locating bearing	Drive end Standard motors (B3, B5, B14): side B Motors for gearbox direct mounting: side A		
Colour	RAL9005M		

¹⁾ Not possible for UR version.

MD□KS synchronous servo motors



General information

Dimensioning

Speed-dependent safety functions

Single encoder concepts with resolvers

Servo motors can perform speed-dependent safety functions for safe speed and / or safe relative position monitoring in a drive system with the Servo Drives 9400. The SM301 safety module, which can be integrated in the Servo Drives 9400, is used to implement these functions. When planning systems/installations of this kind, the following must always be observed:

When using just one single feedback system in the environment of these safety applications, the applicable safety engineering standard IEC 61800-5-2 [Adjustable speed electrical power drive systems - Part: 5-2: Safety requirements - Functional] stipulates special requirements for the connection between feedback system and motor shaft. This is due to the fact that two-channel safety systems at this point in the mechanical system are actually designed as single-channel systems. If this mechanical connection is designed with considerable overdimensioning, the standard permits exclusion of the fault "encoder-shaft breakage" or "encoder-shaft slip". As such, acceleration limit values must not be exceeded for the individual drive solutions. You can find the limit values in the corresponding feedback data of the individual motor ranges.

Speed-dependent safety functions in connection with the SM301 safety module

For the following speed-dependent safety functions, the motor-feedback system combinations listed in the following table are available:

- Safe stop 1 (SS1)
- Safe operational stop (SOS)
- Safely Limited Speed (SLS)
- Safe Maximum Speed (SMS)

- Safe direction (SDI)
- Operation mode selector (OMS) with confirmation (ES)
- Safe speed monitor (SSM)
- Safely limited increment (SLI).

Encoder type	Encoder type	Product key	Feedback Design	Safe speed monitoring
SinCos absolute value	Single-turn	AS1024-8V-K2		PL d/SIL 2
	Multi-turn	AM1024-8V-K2		PL e/SIL 3
Resolver		RV03		2-encoder concept

MD□KS synchronous servo motors

General information



Dimensioning

Cooling effect of mounting flange

Mounting on a thermally conducting / insulating plate or machine chassis has an influence on heating up the motor, particularly when using naturally ventilated motors.

The motor rating data specified in the catalogue applies when mounting on a steel plate with free convection with the following dimensions:

- MDSKS□□036 / 056 / 071: 270 x 270 mm

Vibrational severity

		MDSKS□□056	MDSKS□□071	MDFKS□□071
Vibrational severity				
IEC/EN 60034-14			A	
Maximum r.m.s. value of the vibration velocity ¹⁾	[mm/s]		1.60	

¹⁾ Free suspension

- ▶ at n = 600 to 3,600 rpm



Dimensioning

Concentricity and axial run-out of the mounting flanges and smooth running of the shaft ends

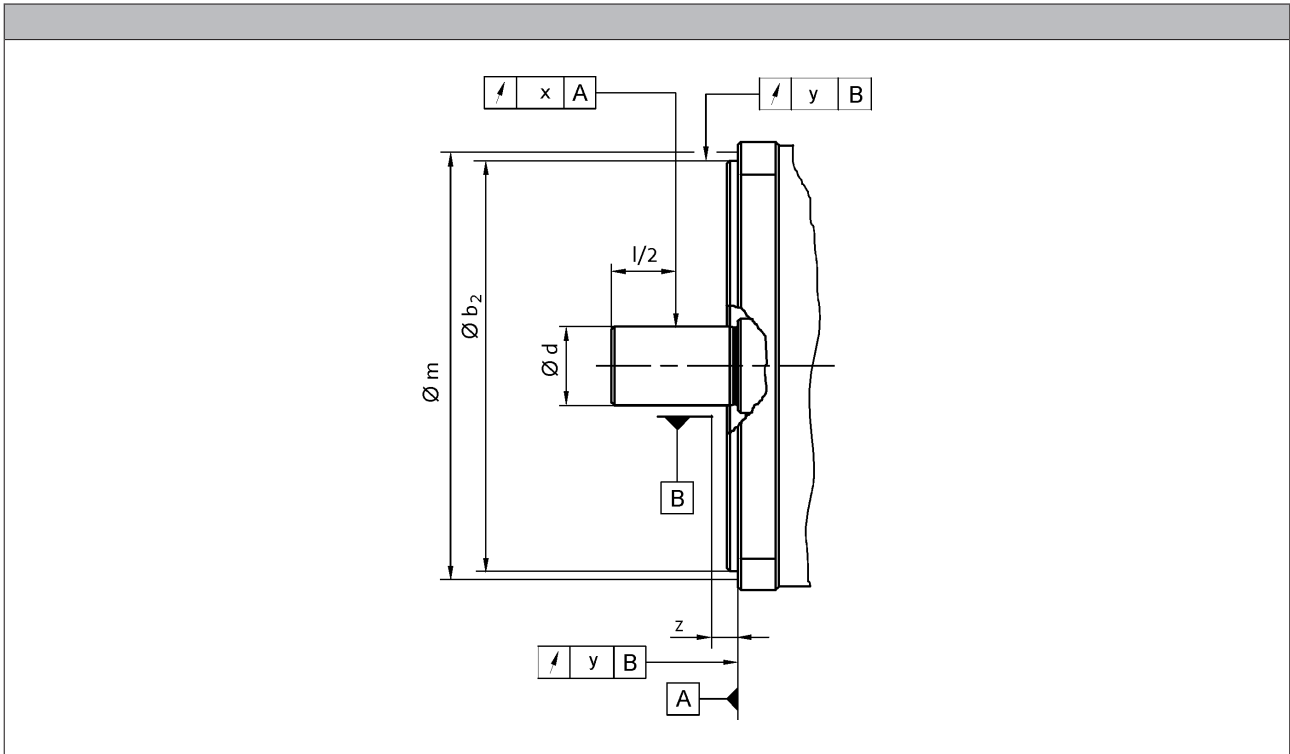

				MDSKS□□056		MDSKS□□071		MDFKS□□071	
Flange size				FF100	FT85	FF130	FT130	FF130	FT130
Dimensions									
	b_2	j6	[mm]	80	70			110	
	d	k6	[mm]						
Distance									
Measuring diameter	m		[mm]	113	98.0			149	
Dial gauge holder for flange check	z	+/- 1	[mm]				10.0		
Concentricity									
IEC 60072							Normal class		
Value	y		[mm]	0.080			0.10		
Axial run-out									
IEC 60072							Normal class		
Value	y		[mm]	0.080			0.10		
Smooth running									
IEC 60072							Normal class		
Value	x		[mm]	0.035			0.040		

- Limit values for checking the smooth running of the shaft ends as well as the concentricity and axial run-out of the mounting flange to IEC 60072



Dimensioning

Notes on the selection tables

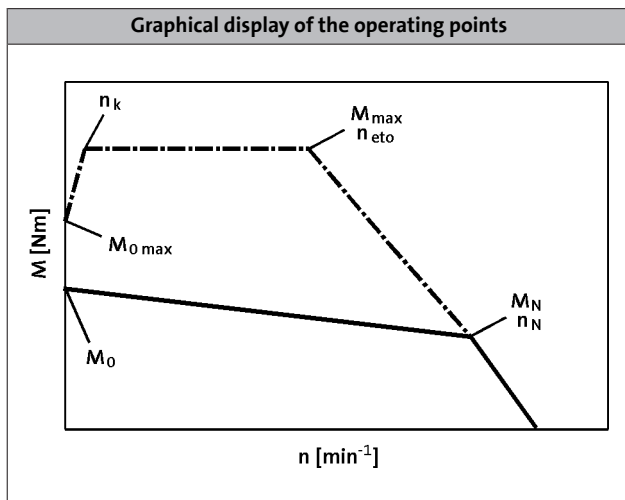

Please note:

- In case of an active load (e.g. vertical drive axes, hoists, test benches, unwinders), $M_{0\ max}$ has to be considered
- In case of a passive load (e.g. horizontal drive axes), $M_{\ max}$ can be usually used
- In case of a speed $< n_k$ and inverter-specifically, the achievable torque $M_{0\ max}$ is smaller than $M_{\ max}$
- In case of a speed $n = 0$, the standstill torque M_0 and the standstill current I_0 have to be reduced by 30% after 2 seconds. In case of applications which require a longer holding of M_0 , we recommend the drive to be held via the holding brake and reduce the current, e.g. by controller inhibit.
- In case of servo inverters, the switching frequency dependent overload capacity is considered in the default setting. For more information, see the servo inverter catalogue.

	n_k [r/min]
MCS	75.0
MDSKS	100
MDFKS	

Further selection tables with different switching frequencies are available with the following codes:

- DS_ZT_MCS_0001
- DS_ZT_MCA_0001
- DS_ZT_MDSKS_0001
- DS_ZT_MDFKS_0001

Simply enter this code (e.g. DS_ZT_MCS_0001) as a search string at www.lenze.de/dsc and you will be given the information immediately in the form of a PDF format.



Dimensioning

Notes on the torque characteristics

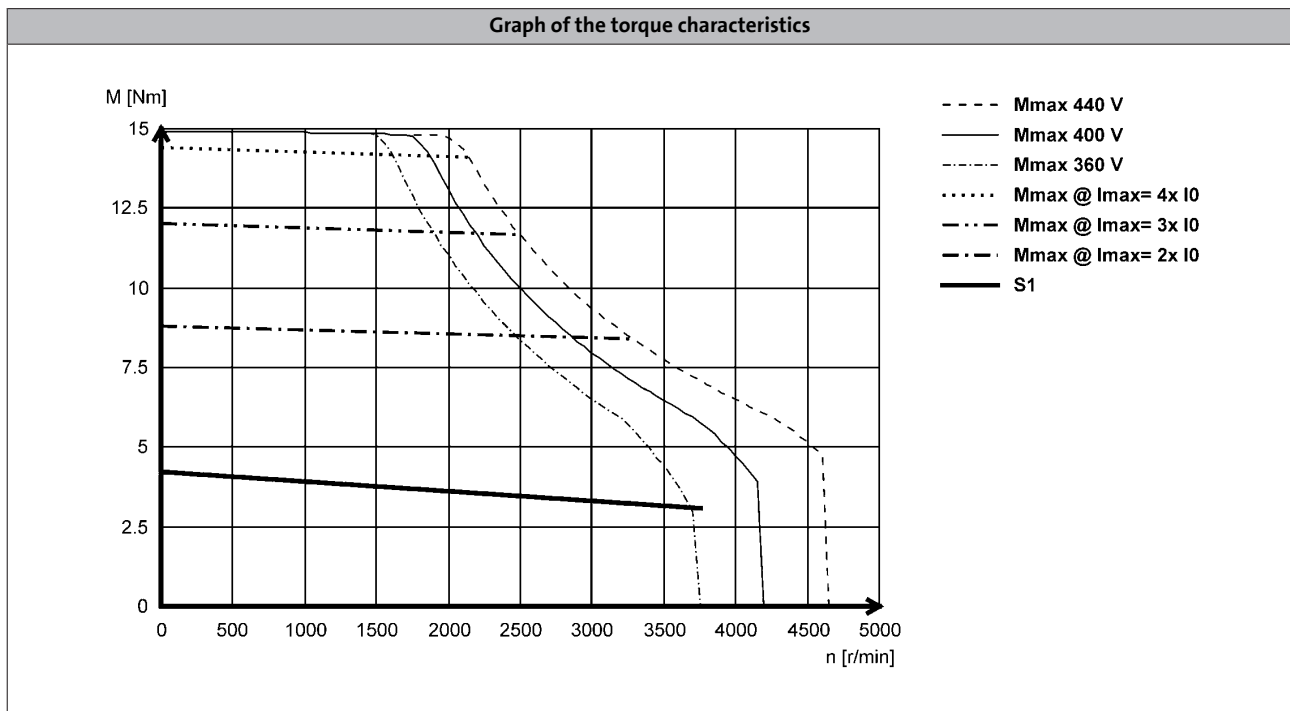

With synchronous servo motors, the limit torque characteristics that result from the selection of servo inverters with maximum currents are also shown alongside the characteristics for continuous operation (S1). These correspond to a multiple of the motor standstill current (2x I₀ to 4x I₀).

Characteristics in the Internet

Torque characteristics for selectable motor/inverter combinations can be determined in the EASY Product Finder in the Internet. The S1 continuous characteristic and the max. limit characteristic are generated. The result can be saved or printed in a PDF protocol. In the EASY Explorer, available torque characteristics are provided automatically.

Further information on the terms switching frequency and default setting can be found in the respective operating instructions of the servo inverter.



Dimensioning

Influence of ambient temperature and site altitude

The information relating to the servo motors in the tables and graphs is valid for a maximum ambient temperature (T_{opr}) of 40 °C and a site altitude (H) up to 1000 m above sea level. The torque correction factor (k_{M1}) shall be applied to the S1 torque characteristic ($M_0...M_N$) in the event of differing installation conditions.

- The maximum permissible ambient temperature (T_{opr}) for servo motors with blowers is 40 °C

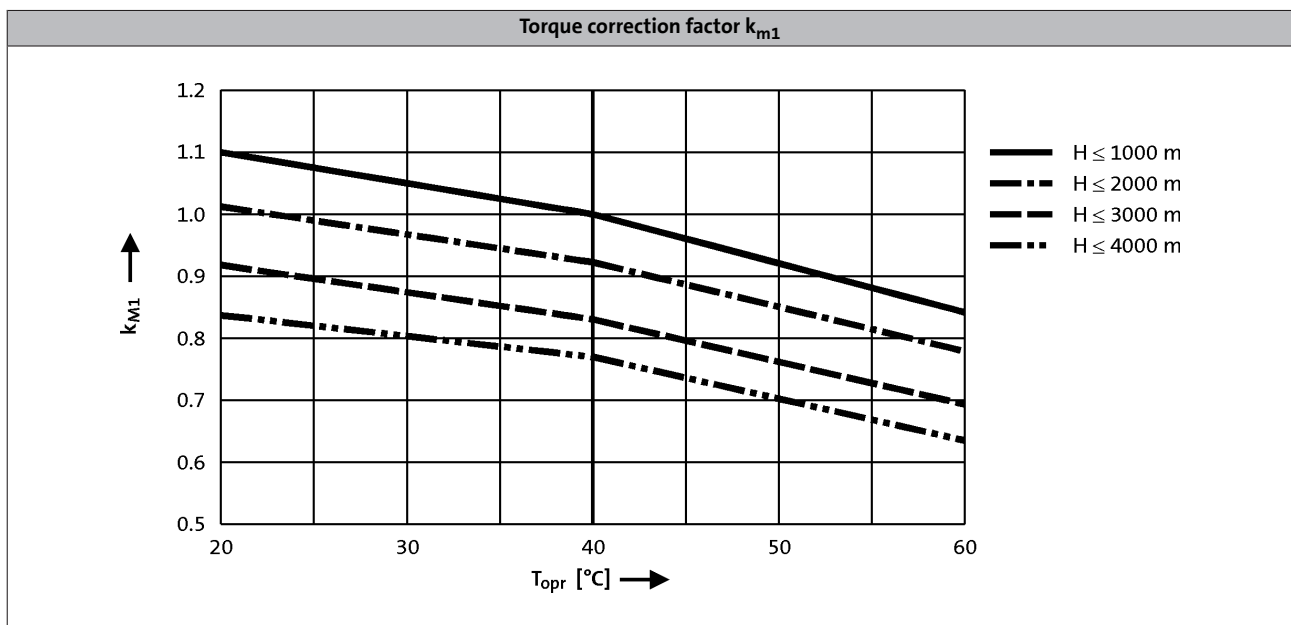

MD□KS synchronous servo motors

Technical data



Standards and operating conditions

			MDSKS	MDFKS
Cooling type			Naturally ventilated	Blower
Degree of protection				
EN 60529			IP54 IP65	IP54
Temperature class				
IEC/EN 60034-1; utilisation			F	
IEC/EN 60034-1; insulation system (enamel-insulated wire)			H	
Conformity				
CE			Low-Voltage Directive 2006/95/EC	
EAC			TP TC 004/2011 (TR CU 004/2011)	
Approval				
			UkrSEPRO	
CSA ¹⁾			CSA 22.2 No. 100	
cURus ¹⁾			UL 1004-1 UL 1004-6 Power Conversion Equipment (File-No. E210321)	
Max. voltage load				
IEC/TS 60034-25			Pulse voltage limiting curve A	
Smooth running				
IEC 60072			Normal class	
Axial run-out				
IEC 60072			Normal class	
Concentricity				
IEC 60072			Normal class	
Mechanical ambient conditions (vibration)				
IEC/EN 60721-3-3			3M6	
Min. ambient operating temperature				
Without brake	T _{opr,min}	[°C]	-20	-15
With brake	T _{opr,min}	[°C]	-10	
Max. ambient operating temperature				
	T _{opr,max}	[°C]	40	
Max. surface temperature				
	T	[°C]	140	110
Mechanical tolerance				
Flange centring diameter			b ₂ ≤ 230 mm = j6 b ₂ > 230 mm = h6	
Shaft diameter			d ≤ 50 mm = k6 d > 50 mm = m6	
Site altitude				
Amsl	H _{max}	[m]	4000	

¹⁾ Optional on request.



Permissible radial and axial forces

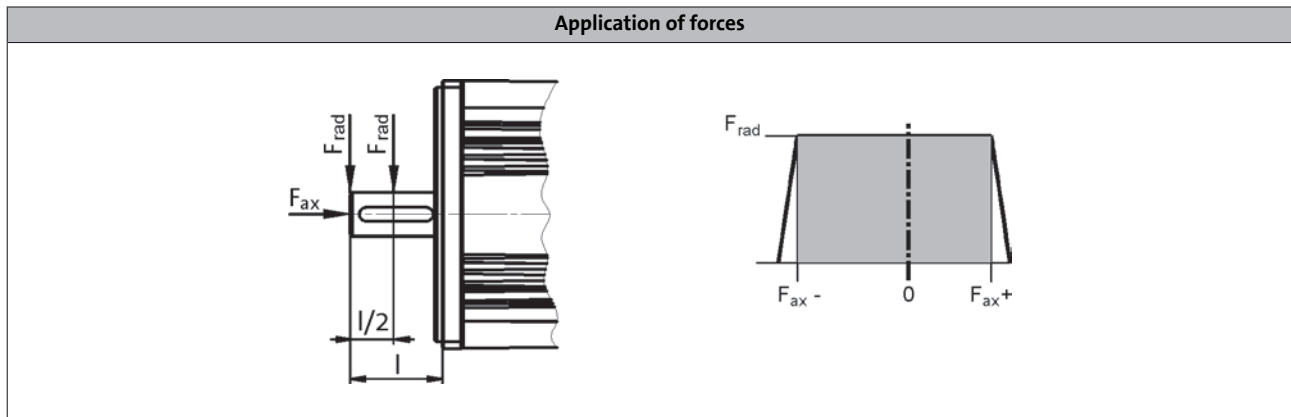

Application of force at l/2

	Bearing service life L_{10}														
	5000 h			10000 h			20000 h			30000 h			50000 h		
	F_{rad}	$F_{ax,-}$	$F_{ax,+}$	F_{rad}	$F_{ax,-}$	$F_{ax,+}$	F_{rad}	$F_{ax,-}$	$F_{ax,+}$	F_{rad}	$F_{ax,-}$	$F_{ax,+}$	F_{rad}	$F_{ax,-}$	$F_{ax,+}$
	[N]	[N]	[N]	[N]	[N]	[N]	[N]	[N]	[N]	[N]	[N]	[N]	[N]	[N]	[N]
MDSKS□□056	590	-90	280	470	-40	230	370	0	190	310	10	180	220	10	180
MDSKS□□071	910	-50	520	700	20	450	430	20	450		20	450	50	-50	520
MDFKS□□071															

Application of force at l

5.3

	Bearing service life L_{10}														
	5000 h			10000 h			20000 h			30000 h			50000 h		
	F_{rad}	$F_{ax,-}$	$F_{ax,+}$	F_{rad}	$F_{ax,-}$	$F_{ax,+}$	F_{rad}	$F_{ax,-}$	$F_{ax,+}$	F_{rad}	$F_{ax,-}$	$F_{ax,+}$	F_{rad}	$F_{ax,-}$	$F_{ax,+}$
	[N]	[N]	[N]	[N]	[N]	[N]	[N]	[N]	[N]	[N]	[N]	[N]	[N]	[N]	[N]
MDSKS□□056	550	-90	280	430	-40	230	340	0	190	290	10	180	200	10	180
MDSKS□□071	820	-50	520	630	20	450	390	20	450	280	20	450	40	-50	520
MDFKS□□071															

- The values for the bearing service life L_{10} refer to an average speed of 4000 r/min. Depending on the ambient temperatures, the service life of the bearings is also reduced by the grease life-time.

MD□KS synchronous servo motors

Technical data



Rated data, non-ventilated

► The data applies to a mains connection voltage of 3 x 400 V.

	n_N [r/min]	M_0 [Nm]	M_N [Nm]	M_{max} [Nm]	P_N [kW]	I_0 [A]	I_N [A]	I_{max} [A]	$U_{N,AC}$ [V]	f_N [Hz]
MDSKS□□056-23	3800	3.20	2.80	11.6	1.10	2.60	2.30	10.0	330	190
MDSKS□□056-33	4000	4.70	4.20	17.2	1.80	4.00	3.60	16.0	325	200
MDSKS□□071-03	3400	6.70	5.70	23.6	2.00	4.90	4.20	19.0	330	170
MDSKS□□071-13	3700	10.0	8.30	35.2	3.20	8.40	7.00	32.0	325	185
MDSKS□□071-33	3600	14.7	12.3	52.0	4.60	11.9	10.0	45.0	325	180

	$\eta_{100\%}$ [%]	$J^{1)}$ [kgcm ²]	$KE_{LL,150\text{ °C}}$ [V / (1000 r/min)]	$R_{UV,20\text{ °C}}$ [Ω]	$R_{UV,150\text{ °C}}$ [Ω]	L_N [mH]	$Kt_{0,150\text{ °C}}$ [Nm/A]	$n_{max}^{2)}$ [r/min]	$m^{1)}$ [kg]
MDSKS□□056-23	85.0	1.20	78.1	10.1	13.6	17.1	1.23	5500	5.30
MDSKS□□056-33	87.0	1.80	74.6	5.10	6.90	10.8	1.18	5500	6.30
MDSKS□□071-03	85.0	6.00	93.0	3.40	4.60	10.6	1.37	5000	8.90
MDSKS□□071-13	82.0	8.00	84.5	1.50	2.10	5.30	1.19	5000	10.9
MDSKS□□071-33	82.0	10.0	88.2	1.10	1.60	5.80	1.24	5000	13.0

¹⁾ Without brake.

²⁾ Mechanically permissible maximum speed.

Rated data, forced ventilated

► The data applies to a mains connection voltage of 3 x 400 V.

	n_N [r/min]	M_0 [Nm]	M_N [Nm]	M_{max} [Nm]	P_N [kW]	I_0 [A]	I_N [A]	I_{max} [A]	$U_{N,AC}$ [V]	f_N [Hz]
MDFKS□□071-03	3300	8.80	7.50	23.6	2.60	6.60	5.60	19.0	330	165
MDFKS□□071-13	3600	13.3	11.0	35.2	4.10	11.1	9.20	32.0	325	180
MDFKS□□071-33	3500	19.3	16.2	52.0	5.90	15.6	13.1	45.0	325	175

	$\eta_{100\%}$ [%]	$J^{1)}$ [kgcm ²]	$KE_{LL,150\text{ °C}}$ [V / (1000 r/min)]	$R_{UV,20\text{ °C}}$ [Ω]	$R_{UV,150\text{ °C}}$ [Ω]	L_N [mH]	$Kt_{0,150\text{ °C}}$ [Nm/A]	$n_{max}^{2)}$ [r/min]	$m^{1)}$ [kg]
MDFKS□□071-03	81.0	6.00	93.0	3.40	4.60	10.6	1.33	5000	10.2
MDFKS□□071-13	79.0	8.00	84.5	1.50	2.10	5.30	1.20	5000	12.2
MDFKS□□071-33	80.0	10.0	88.2	1.10	1.60	5.80	1.24	5000	12.2

³⁾ Without brake.

⁴⁾ Mechanically permissible maximum speed.

MD□KS synchronous servo motors

Technical data



Selection tables, Servo Drives 9400 HighLine

Non-ventilated motors

- The data applies to a mains connection voltage of 3 x 400 V and an inverter switching frequency of 4 kHz.

					E94A□□	E0024	E0034	E0044	E0074	E0094	E0134	E0174
					I_N	1.9	3.1	5.0	8.8	11.7	16.3	20.6
					$I_{0,max}$	6.0	10.0	16.0	21.0	28.0	39.0	49.5
MDSKS	M_N	n_N	I_N	P_N	I_{max}	6.0	10.0	16.0	21.0	28.0	39.0	49.5
056-23	2.8	3800	2.3	1.10	M_0	2.3	3.2					
					M_N	2.3	2.8					
					$M_{0,max}$	7.5	11.6					
					M_{max}	7.5	11.6					
					η_{eto}	-	-					
056-33	4.2	4000	3.6	1.80	M_0		3.6	4.7				
					M_N		3.6	4.2				
					$M_{0,max}$		12.0	17.2				
					M_{max}		12.0	17.2				
					η_{eto}		-	-				
071-03	5.7	3400	4.2	2.00	M_0		4.2	6.7	6.7			
					M_N		4.2	5.7	5.7			
					$M_{0,max}$		15.2	21.4	23.6			
					M_{max}		15.2	21.4	23.6			
					η_{eto}		-	-	-			
071-13	8.3	3700	7.0	3.20	M_0			6.0	10.0	10.0	10.0	
					M_N			5.9	8.3	8.3	8.3	
					$M_{0,max}$			22.0	27.1	32.7	35.2	
					M_{max}			22.0	27.1	32.7	35.2	
					η_{eto}			-	-	-	-	
071-33	12.3	3600	10.0	4.60	M_0				10.9	14.3	14.7	14.7
					M_N				10.8	12.3	12.3	12.3
					$M_{0,max}$				31.2	38.9	48.3	52.0
					M_{max}				31.2	38.9	48.3	52.0
					η_{eto}				-	-	-	-

- I... [A], M... [Nm], n... [r/min], P... [kW]

MD□KS synchronous servo motors

Technical data



Selection tables, Servo Drives 9400 HighLine

Forced ventilated IP54 motors

- The data applies to a mains connection voltage of 3 x 400 V and an inverter switching frequency of 4 kHz.

					E94A□□	E0044	E0074	E0094	E0134	E0174
					I_N	5.0	8.8	11.7	16.3	20.6
					$I_{0,max}$	16.0	21.0	28.0	39.0	49.5
MDFKS	M_N	n_N	I_N	P_N	I_{max}	16.0	21.0	28.0	39.0	49.5
071-03	7.5	3300	5.6	2.60	M_0	6.7	8.8			
					M_N	6.7	7.5			
					$M_{0,max}$	21.6	23.6			
					M_{max}	21.6	23.6			
					η_{eto}	-	-			
071-13	11.0	3600	9.2	4.10	M_0		10.5	13.3	13.3	
					M_N		10.5	11.0	11.0	
					$M_{0,max}$		27.8	33.1	35.2	
					M_{max}		27.8	33.1	35.2	
					η_{eto}		-	-	-	
071-33	16.2	3500	13.1	5.90	M_0			14.4	19.3	19.3
					M_N			14.3	16.2	16.2
					$M_{0,max}$			40.0	48.8	52.0
					M_{max}			40.0	48.8	52.0
					η_{eto}			-	-	-

- $I...$ [A], $M...$ [Nm], $n...$ [r/min], $P...$ [kW]

MD□KS synchronous servo motors

Technical data



Selection tables, Inverter Drives 8400 TopLine

Non-ventilated motors

- The data applies to a mains connection voltage of 3 x 400 V and an inverter switching frequency of 8 kHz.

					E84AVTC	□5514	□7514	□1124	□1524	□2224	□3024	□4024	□5524	□7524	□1134	□1534
					I_N	1.8	2.4	3.2	3.9	5.9	7.3	9.5	13.0	16.5	23.5	32.0
					$I_{0,max}$	2.7	3.6	4.8	5.9	8.4	11.0	14.3	19.5	26.4	32.9	43.2
MDSKS	M_N	n_N	I_N	P_N	I_{max}	3.6	4.8	6.4	7.8	11.2	14.6	19.0	26.0	33.0	47.0	64.0
056-23	2.8	3800	2.3	1.10	M_0	2.4	3.1	3.2	3.2	3.2	3.2					
					M_N	2.2	2.8	2.8	2.8	2.8	2.8					
					$M_{0,max}$	4.6	6.2	8.0	9.8	11.6	11.6					
					M_{max}	4.6	6.2	8.0	9.8	11.6	11.6					
					η_{eto}	-	-	-	-	-	-					
056-33	4.2	4000	3.6	1.80	M_0			4.1	4.6	4.7	4.7	4.7	4.7			
					M_N			3.7	4.2	4.2	4.2	4.2	4.2			
					$M_{0,max}$			8.2	10.0	14.0	17.2	16.8	17.2			
					M_{max}			8.2	10.0	14.0	17.2	16.8	17.2			
					η_{eto}			-	-	-	-	-	-			
071-03	5.7	3400	4.2	2.00	M_0			4.3	5.3	6.7	6.7	6.7	6.7			
					M_N			4.3	5.3	5.7	5.7	5.7	5.7			
					$M_{0,max}$			10.5	12.8	17.8	22.0	23.0	23.6			
					M_{max}			10.5	12.8	17.8	22.0	23.0	23.6			
					η_{eto}			-	-	-	-	-	-			
071-13	8.3	3700	7.0	3.20	M_0					7.0	8.7	10.0	10.0	10.0	10.0	
					M_N					7.0	8.7	8.3	8.3	8.3	8.3	
					$M_{0,max}$					17.4	21.6	25.0	29.3	29.3	29.3	
					M_{max}					17.4	21.6	25.0	34.3	35.2	35.2	
					η_{eto}					-	-	-	-	-	-	
071-33	12.3	3600	10.0	4.60	M_0							14.0	14.7	14.7	14.7	14.7
					M_N							11.7	12.3	12.3	12.3	12.3
					$M_{0,max}$							28.5	39.1	42.7	42.7	42.7
					M_{max}							28.5	39.1	52.0	52.0	52.0
					η_{eto}							-	-	-	-	-

- I... [A], M... [Nm], n... [r/min], P... [kW]

MD□KS synchronous servo motors

Technical data



Selection tables, Inverter Drives 8400 TopLine

Forced ventilated IP54 motors

- The data applies to a mains connection voltage of 3 x 400 V and an inverter switching frequency of 8 kHz.

					E84AVTC	□1124	□1524	□2224	□3024	□4024	□5524	□7524	□1134	□1534
					I_N	3.2	3.9	5.9	7.3	9.5	13.0	16.5	23.5	32.0
					$I_{0,max}$	4.8	5.9	8.4	11.0	14.3	19.5	26.4	32.9	43.2
MDFKS	M_N	n_N	I_N	P_N	I_{max}	6.4	7.8	11.2	14.6	19.0	26.0	33.0	47.0	64.0
071-03	7.5	3300	5.6	2.60	M_0	4.3	5.2	8.8	8.8	8.8	8.8			
					M_N	4.3	5.2	7.5	7.5	7.5	7.5			
					$M_{0,max}$	8.6	10.4	18.3	22.7	23.0	23.6			
					M_{max}	8.6	10.4	18.3	22.7	23.0	23.6			
					η_{eto}	-	-	-	-	-	-			
071-13	11.0	3600	9.2	4.10	M_0			7.1	8.8	13.3	13.3	13.3	13.3	
					M_N			7.1	8.8	11.0	11.0	11.0	11.0	
					$M_{0,max}$			14.2	17.5	25.7	29.9	29.9	29.3	
					M_{max}			14.2	17.5	25.7	35.2	35.2	35.2	
					η_{eto}			-	-	-	-	-	-	
071-33	16.2	3500	13.1	5.90	M_0					11.8	16.1	19.3	19.3	19.3
					M_N					11.8	16.1	16.2	16.2	16.2
					$M_{0,max}$					29.7	40.7	43.6	43.6	43.6
					M_{max}					29.7	40.7	52.0	52.0	52.0
					η_{eto}					-	-	-	-	-

- $I...$ [A], $M...$ [Nm], $n...$ [r/min], $P...$ [kW]

MD□KS synchronous servo motors

Technical data



Selection tables, Servo Drives ECS

Non-ventilated motors

- The data applies to a mains connection voltage of 3 x 400 V and an inverter switching frequency of 4 kHz.

					ECS□□	008C□B	016C□B	032C□B	048C□B
					I_N	4.0	8.0	12.7	17.0
					$I_{0,max}$	4.6	9.1	18.1	27.2
MDSKS	M_N	n_N	I_N	P_N	I_{max}	8.0	16.0	32.0	48.0
056-23	2.8	3800	2.3	1.10	M_0	3.2	3.2		
					M_N	2.8	2.8		
					$M_{0,max}$	5.9	10.7		
					M_{max}	9.6	11.6		
					n_{eto}	2816	2452		
056-33	4.2	4000	3.6	1.80	M_0	4.7	4.7		
					M_N	4.2	4.2		
					$M_{0,max}$	5.4	11.1		
					M_{max}	9.9	17.2		
					n_{eto}	3620	2705		
071-03	5.7	3400	4.2	2.00	M_0	5.5	6.7		
					M_N	5.4	5.7		
					$M_{0,max}$	6.2	14.1		
					M_{max}	12.7	21.4		
					n_{eto}	3177	2750		
071-13	8.3	3700	7.0	3.20	M_0		9.5	10.0	
					M_N		8.3	8.3	
					$M_{0,max}$		10.8	24.3	
					M_{max}		22.0	35.2	
					n_{eto}		3517	3000	
071-33	12.3	3600	10.0	4.60	M_0		9.9	14.7	14.7
					M_N		9.8	12.3	12.3
					$M_{0,max}$		11.2	27.6	38.1
					M_{max}		24.8	42.7	52.0
					n_{eto}		3368	2840	2350

- $I...$ [A], $M...$ [Nm], $n...$ [r/min], $P...$ [kW]

MD□KS synchronous servo motors

Technical data



Selection tables, Servo Drives ECS

Forced ventilated IP54 motors

- The data applies to a mains connection voltage of 3 x 400 V and an inverter switching frequency of 4 kHz.

					ECS□□	008C□B	016C□B	032C□B	048C□B
					I_N	4.0	8.0	12.7	17.0
					$I_{0,max}$	4.6	9.1	18.1	27.2
MDFKS	M_N	n_N	I_N	P_N	I_{max}	8.0	16.0	32.0	48.0
071-03	7.5	3300	5.6	2.60	M_0	5.3	8.8		
					M_N	5.4	7.5		
					$M_{0,max}$	6.2	14.6		
					M_{max}	13.2	21.6		
					n_{eto}	3177	2750		
071-13	11.0	3600	9.2	4.10	M_0		9.6	13.3	
					M_N		9.6	11.0	
					$M_{0,max}$		10.9	25.0	
					M_{max}		22.8	35.2	
					n_{eto}		3517	3000	
071-33	16.2	3500	13.1	5.90	M_0			15.7	19.3
					M_N			15.7	16.2
					$M_{0,max}$			22.4	39.2
					M_{max}			43.6	52.0
					n_{eto}			2840	2350

- $I...$ [A], $M...$ [Nm], $n...$ [r/min], $P...$ [kW]

MD□KS synchronous servo motors

Technical data



Selection tables, Servo Inverter 9300

Non-ventilated motors

- The data applies to a mains connection voltage of 3 x 400 V and an inverter switching frequency of 8 kHz.

					EVS	9322-E□	9323-E□	9324-E□	9325-E□	9326-E□	9327-E□	
					I_N	2.5	3.9	7.0	13.0	23.5	32.0	
					$I_{0,max}$	3.8	5.9	10.5	19.5	23.5	32.0	
MDSKS	M_N	n_N	I_N	P_N	I_{max}	3.8	5.9	10.5	19.5	35.3	48.0	
056-23	2.8	3800	2.3	1.10	M_0	3.1	3.2	3.2				
					M_N	2.8	2.8	2.8				
					$M_{0,max}$	4.9	7.4	11.6				
					M_{max}	4.9	7.4	11.6				
					n_{eto}	3601	3248	2452				
056-33	4.2	4000	3.6	1.80	M_0		4.6	4.7	4.7			
					M_N		4.2	4.2	4.2			
					$M_{0,max}$		7.6	12.5	17.2			
					M_{max}		7.6	12.5	17.2			
					n_{eto}		3834	3360	2455			
071-03	5.7	3400	4.2	2.00	M_0		5.3	6.7	6.7			
					M_N		5.3	5.7	5.7			
					$M_{0,max}$		9.7	15.8	23.6			
					M_{max}		9.7	15.8	23.6			
					n_{eto}		3291	3047	2500			
071-13	8.3	3700	7.0	3.20	M_0			8.3	10.0	10.0		
					M_N			8.3	8.3	8.3		
					$M_{0,max}$			15.5	25.7	29.3		
					M_{max}			15.5	25.7	35.2		
					n_{eto}			3690	3418	3000		
071-33	12.3	3600	10.0	4.60	M_0				14.7	14.7	14.7	
					M_N				12.3	12.3	12.3	
					$M_{0,max}$				29.3	34.1	42.7	
					M_{max}				29.3	45.4	52.0	
					n_{eto}				3252	2716	2350	

- I... [A], M... [Nm], n... [r/min], P... [kW]

MD□KS synchronous servo motors

Technical data



Selection tables, Servo Inverter 9300

Forced ventilated IP54 motors

- The data applies to a mains connection voltage of 3 x 400 V and an inverter switching frequency of 8 kHz.

					EVS	9323-E□	9324-E□	9325-E□	9326-E□	9327-E□
					I_N	3.9	7.0	13.0	23.5	32.0
					$I_{0,max}$	5.9	10.5	19.5	23.5	32.0
MDFKS	M_N	n_N	I_N	P_N	I_{max}	5.9	10.5	19.5	35.3	48.0
071-03	7.5	3300	5.6	2.60	M_0	5.2	8.8	8.8		
					M_N	5.2	7.5	7.5		
					$M_{0,max}$	7.9	16.3	23.6		
					M_{max}	7.9	16.3	23.6		
					n_{eto}	3291	3047	2500		
071-13	11.0	3600	9.2	4.10	M_0		8.4	13.3	13.3	
					M_N		8.4	11.0	11.0	
					$M_{0,max}$		12.6	26.4	29.9	
					M_{max}		12.6	26.4	35.2	
					n_{eto}		3690	3418	3000	
071-33	16.2	3500	13.1	5.90	M_0			16.1	19.3	19.3
					M_N			16.1	16.2	16.2
					$M_{0,max}$			30.5	35.2	43.6
					M_{max}			30.5	46.2	52.0
					n_{eto}			3252	2716	2350

- $I...$ [A], $M...$ [Nm], $n...$ [r/min], $P...$ [kW]

MD□KS synchronous servo motors

Technical data



Torque characteristics

► The data applies to a mains connection voltage of 3 x 400 V.

MDSKS□□056-23 (non-ventilated)

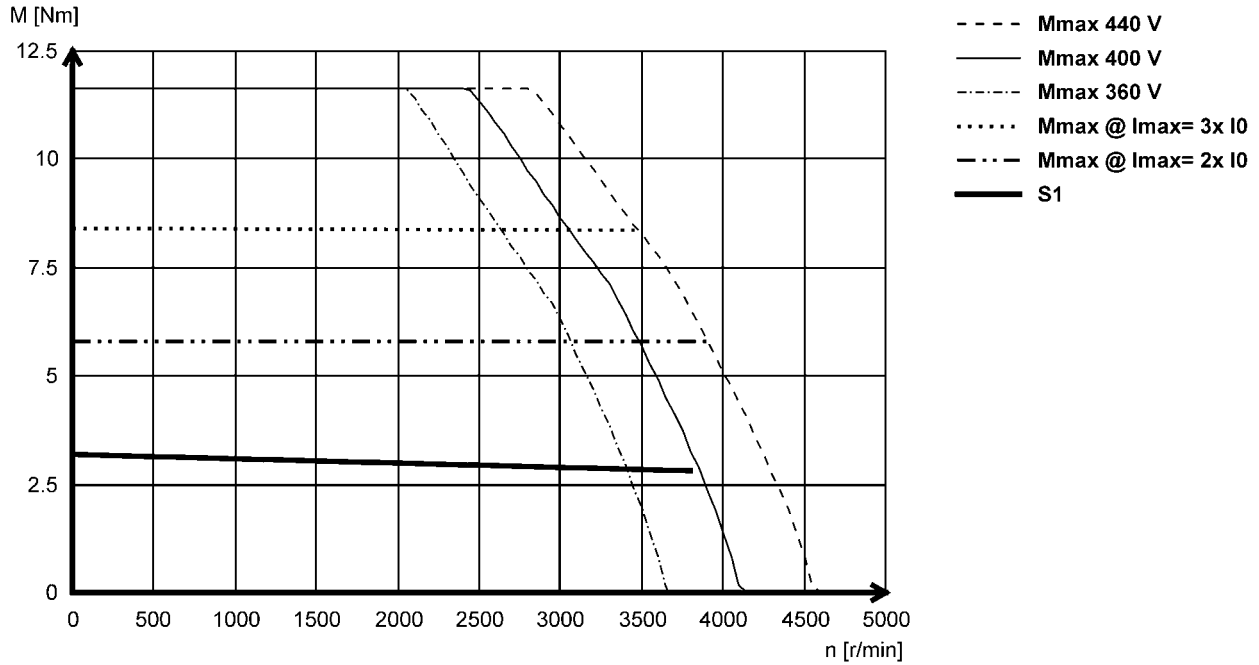

5.3

MDSKS□□056-33 (non-ventilated)

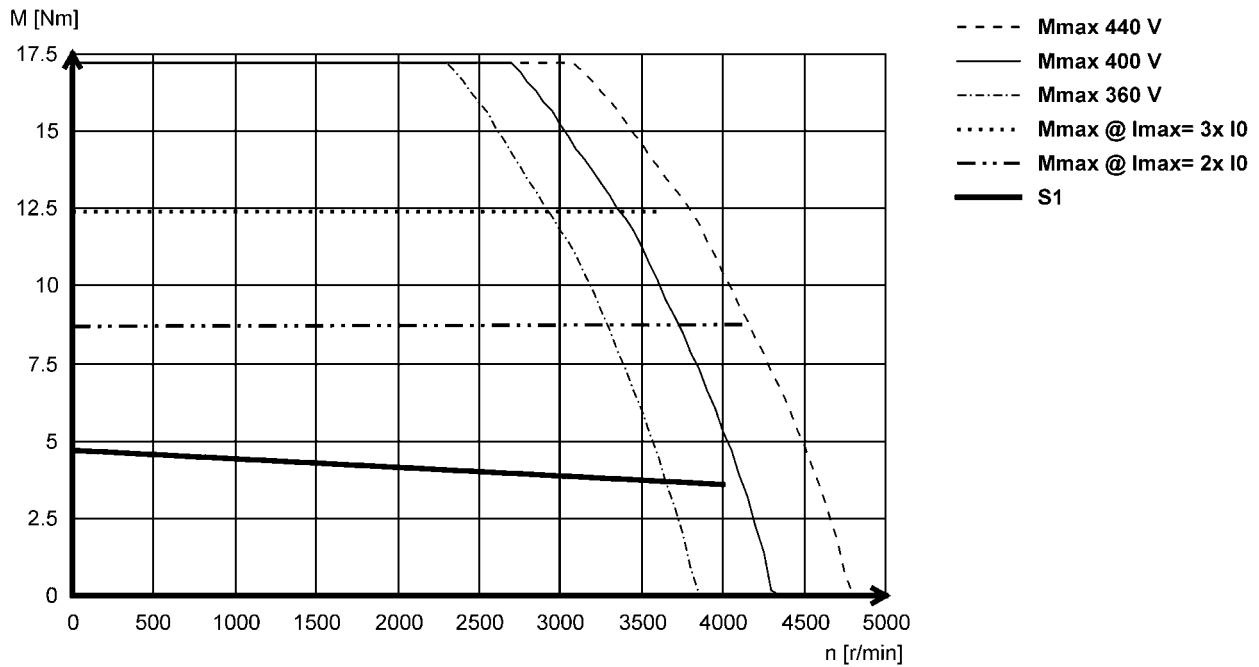

MD□KS synchronous servo motors

Technical data



Torque characteristics

► The data applies to a mains connection voltage of 3 x 400 V.

MDSKS□□071-03 (non-ventilated)

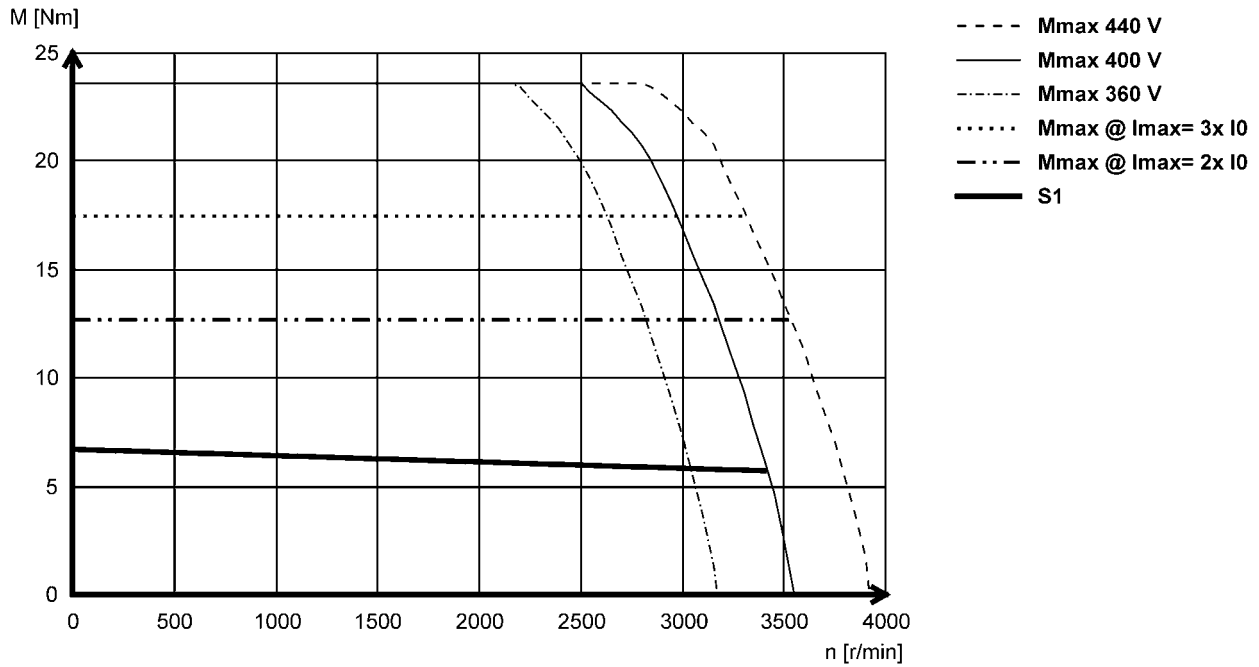

MDFKS□□071-03 (forced ventilated)

5.3

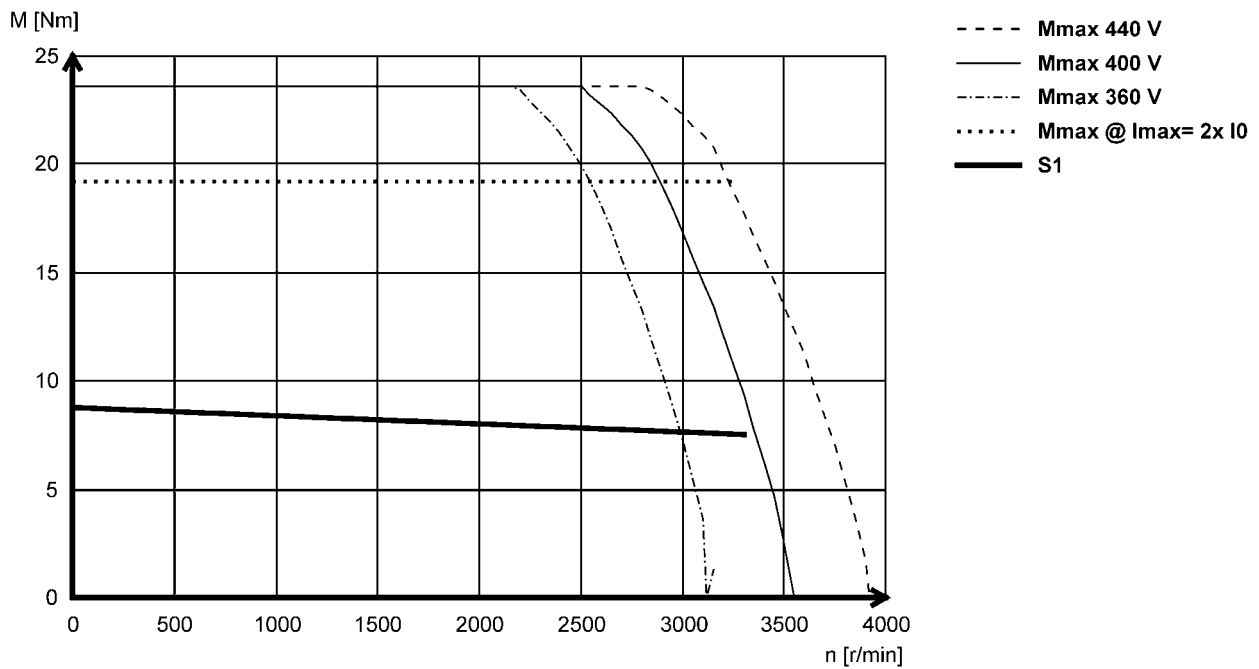

MD□KS synchronous servo motors

Technical data



Torque characteristics

► The data applies to a mains connection voltage of 3 x 400 V.

MDSKS□□071-13 (non-ventilated)

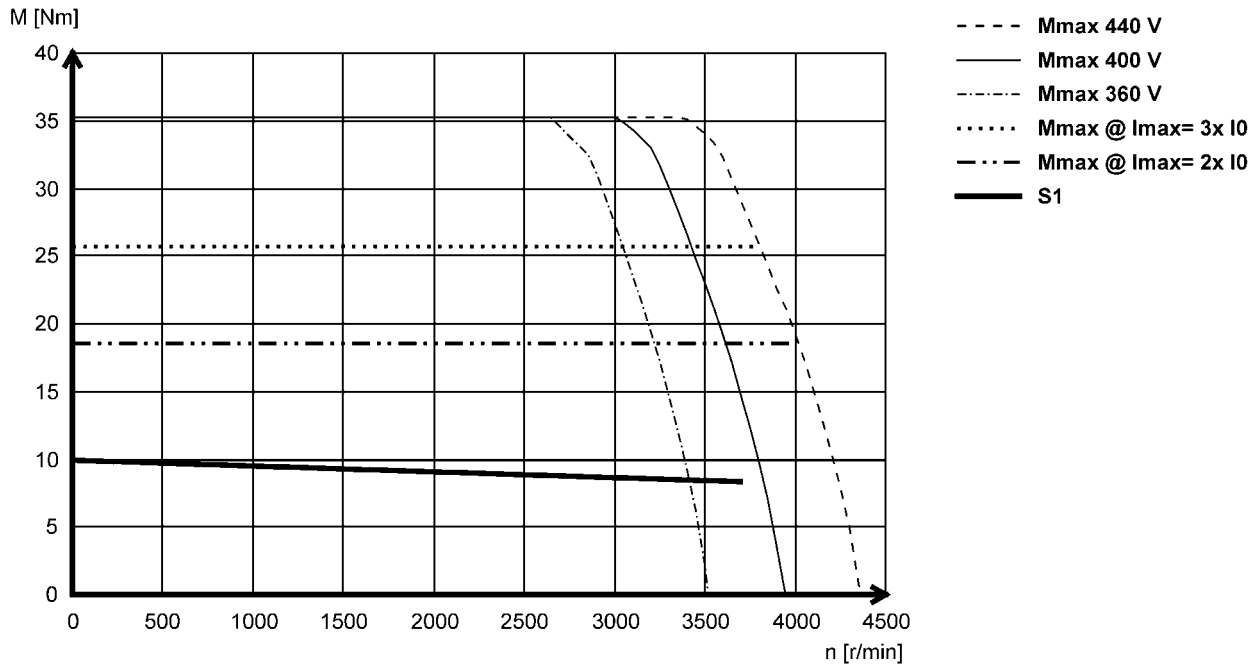

5.3

MDFKS□□071-13 (forced ventilated)

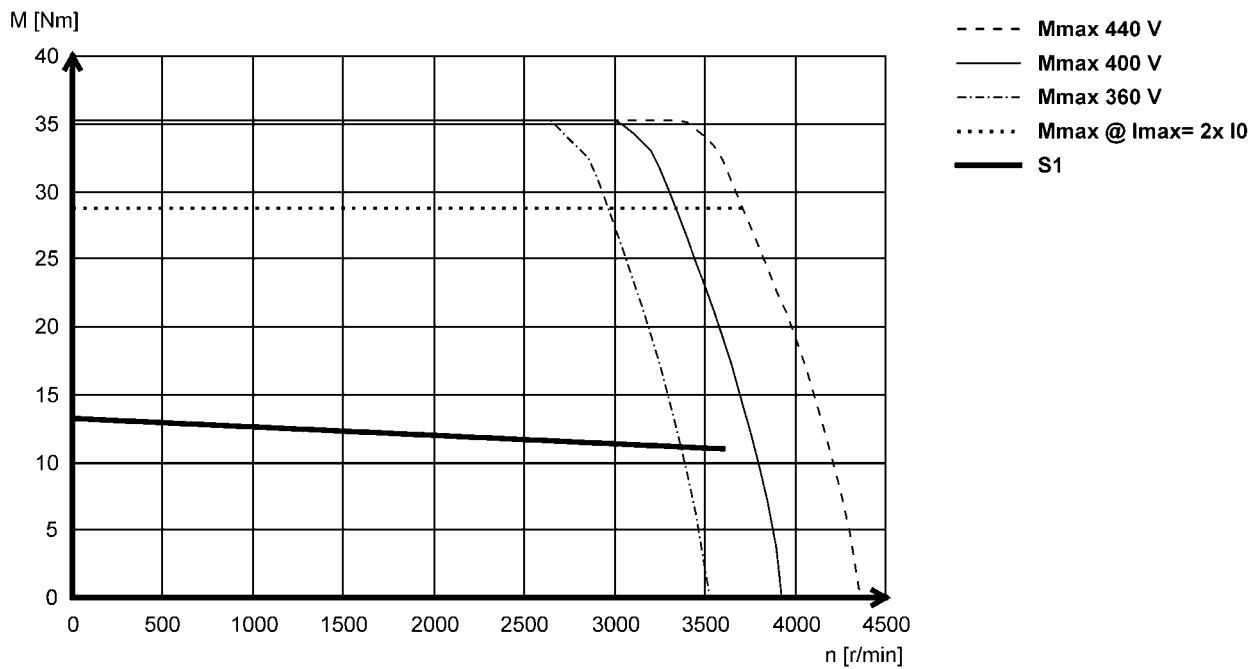

MD□KS synchronous servo motors

Technical data



Torque characteristics

► The data applies to a mains connection voltage of 3 x 400 V.

MDSKS□□071-33 (non-ventilated)

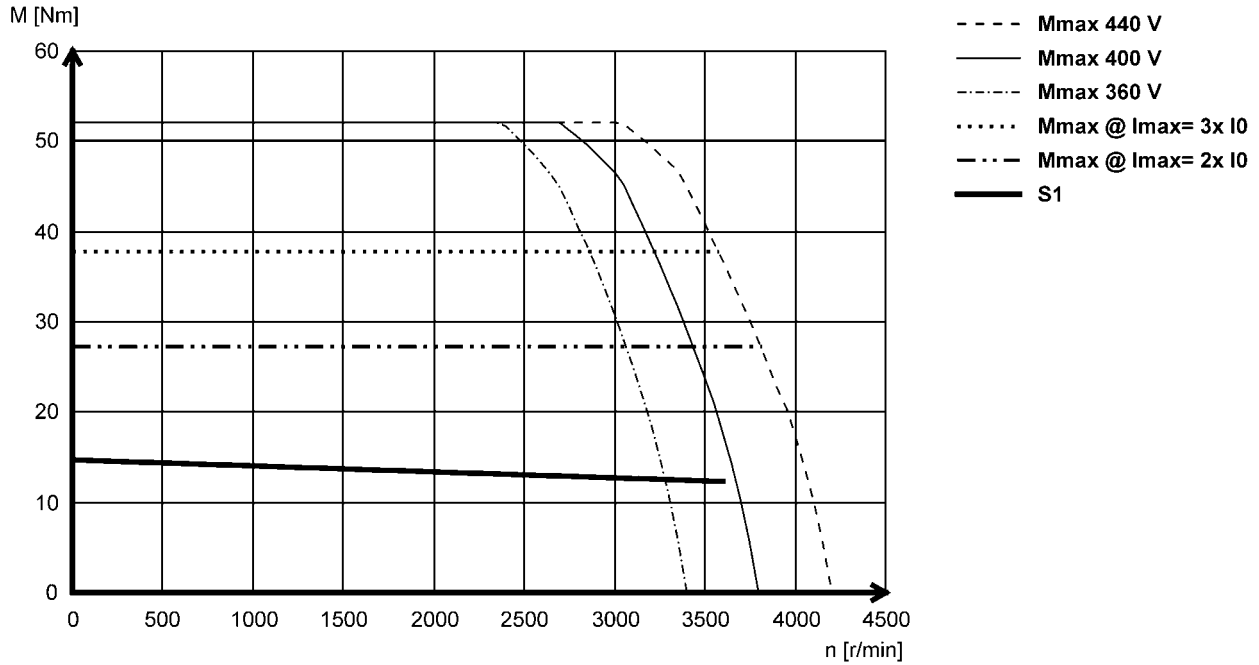

MDFKS□□071-33 (forced ventilated)

5.3

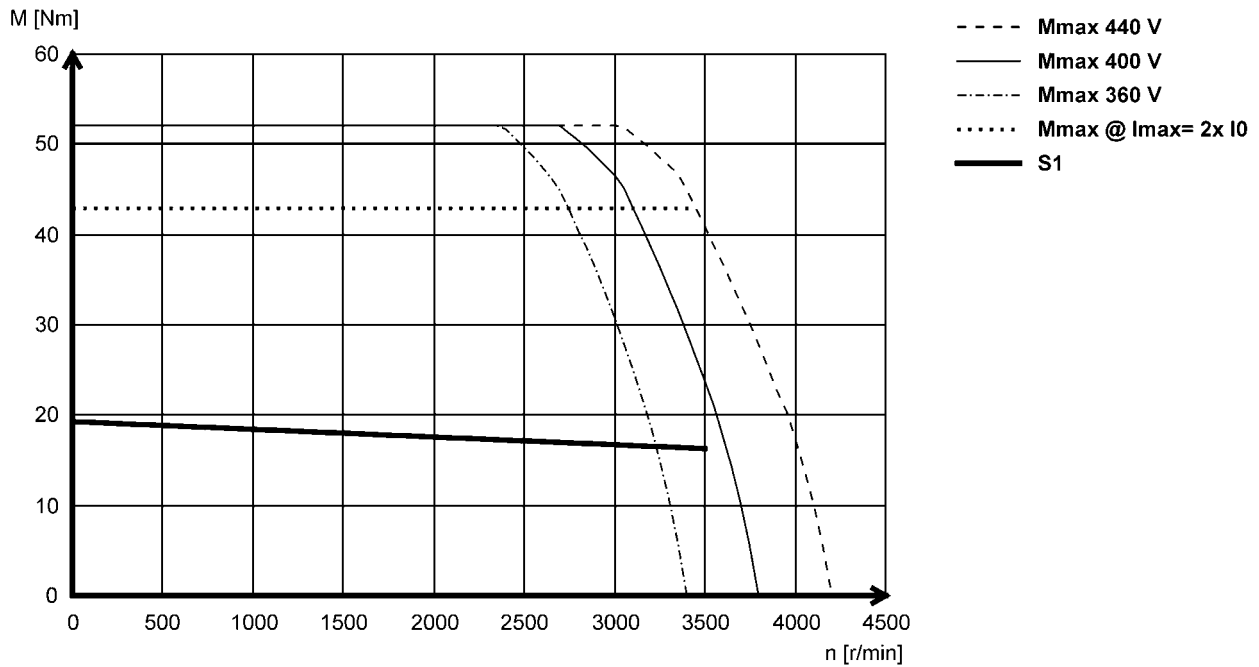

MD□KS synchronous servo motors

Technical data



Dimensions, self-ventilated

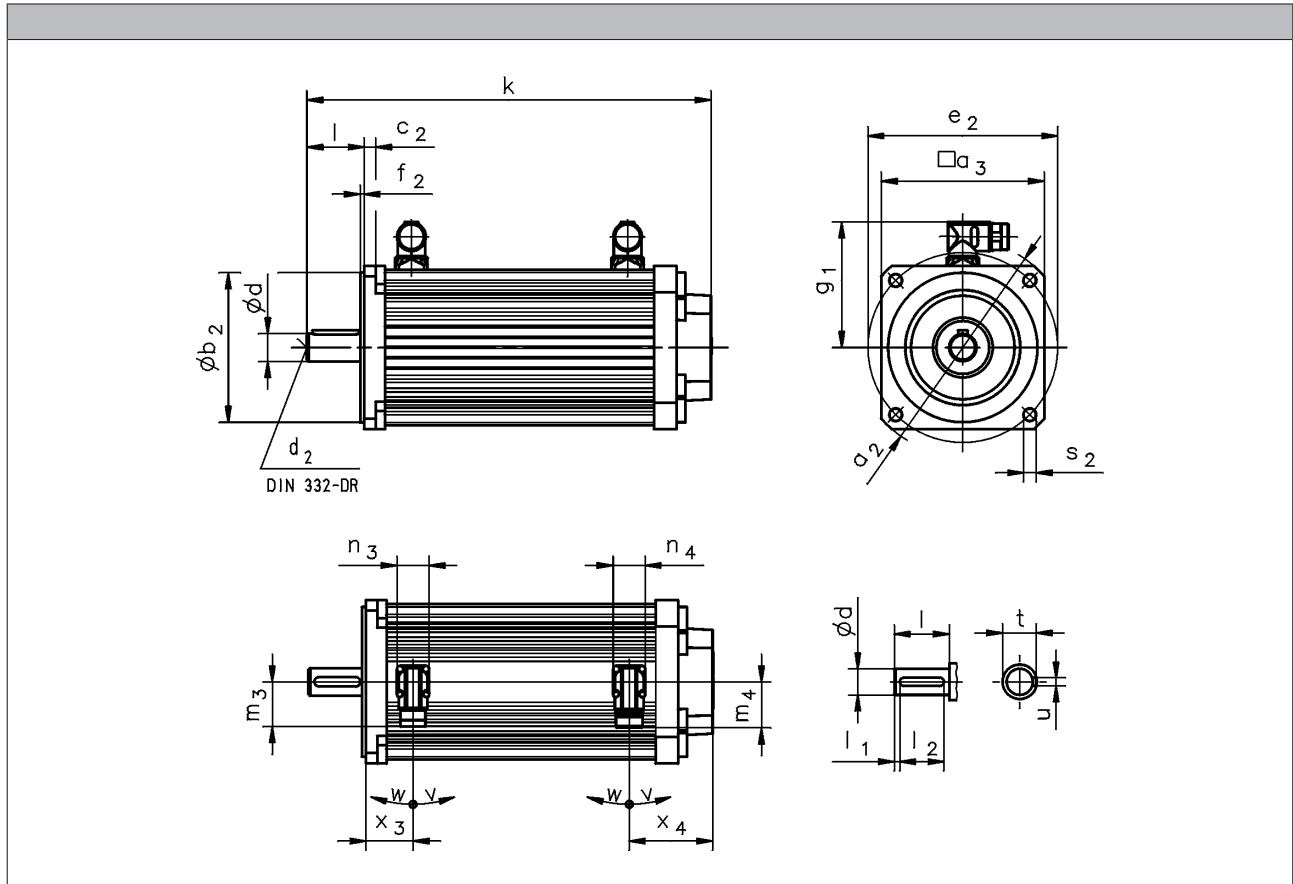

5.3

		MDSKS□□056-23		MDSKS□□056-33	
RS	k [mm]	241		276	
	x_3 [mm]		36		
	x_4 [mm]		60		
BS	k [mm]	267		302	
	x_3 [mm]		59		
	x_4 [mm]		60		
AG / IG	k [mm]	295		330	
	x_3 [mm]		36		
	x_4 [mm]		114		
BA / BI	k [mm]	321		356	
	x_3 [mm]		59		
	x_4 [mm]		114		

		MDSKS□□071-03		MDSKS□□071-13		MDSKS□□071-33	
RS	k [mm]	259		294		329	
	x_3 [mm]			39			
	x_4 [mm]			58			
BS	k [mm]	294		329		364	
	x_3 [mm]			72			
	x_4 [mm]			58			
AG / IG	k [mm]	314		349		384	
	x_3 [mm]			39			
	x_4 [mm]			113			
BA / BI	k [mm]	349		384		419	
	x_3 [mm]			72			
	x_4 [mm]			113			

MDSKS synchronous servo motors

Technical data



Dimensions, self-ventilated

	g ₁ [mm]	n ₃ [mm]	n ₄ [mm]	m ₃ [mm]	m ₄ [mm]	v [°]	w [°]
MDSKS□□056-23	90	28	28	40	40	195	80
MDSKS□□056-33							
MDSKS□□071-03	102						
MDSKS□□071-13							
MDSKS□□071-33							

	d k6 [mm]	d ₂ [mm]	l [mm]	l ₁ [mm]	l ₂ [mm]	u [mm]	t [mm]
MDSKS□□056	14	M5	30	2.5	25	5.0	16.0
MDSKS□□071	19	M6	40	2.0	36	6.0	21.5

		a ₂ [mm]	a ₃ [mm]	b ₂ j6 [mm]	c ₂ [mm]	e ₂ [mm]	f ₂ [mm]	s ₂ [mm]
MDSKS□□056	FF100	120	102	80	8	100	3.0	7
	FT85			70		85	2.5	M6
MDSKS□□071	FF130	160	130	110	9	130	3.5	9.0
	FT130							M8

MD□KS synchronous servo motors

Technical data



Dimensions, forced ventilated

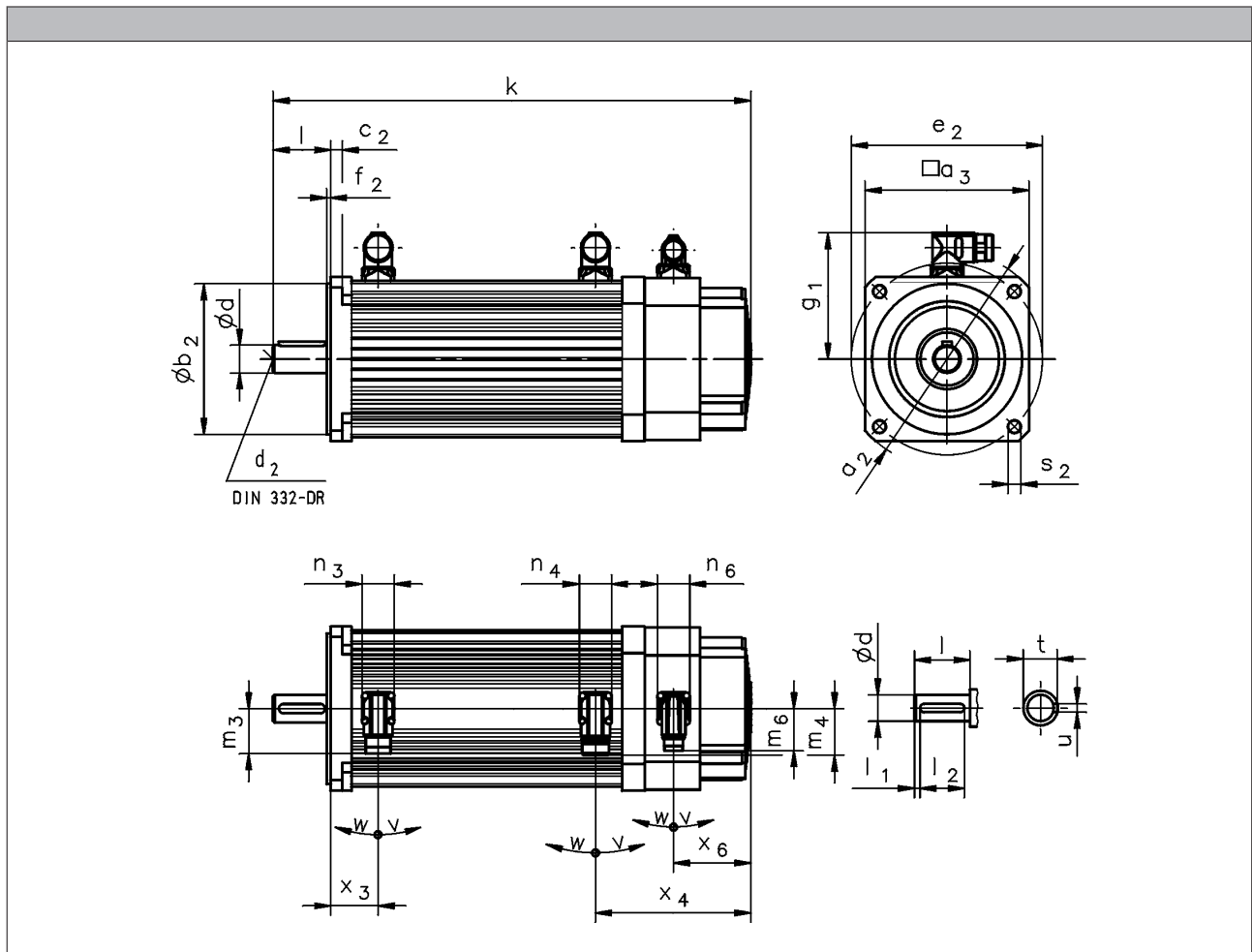

5.3

			MDFKS□□071-03	MDFKS□□071-13	MDFKS□□071-33
RS	k	[mm]	327	362	397
	x ₃	[mm]		39	
	x ₄	[mm]		126	
BS	k	[mm]	362	397	432
	x ₃	[mm]		72	
	x ₄	[mm]		126	
AG / IG	k	[mm]	382	417	452
	x ₃	[mm]		39	
	x ₄	[mm]		181	
BA / BI	k	[mm]	417	452	487
	x ₃	[mm]		72	
	x ₄	[mm]		181	
	x ₆	[mm]		73	

MDFKS synchronous servo motors

Technical data



Dimensions, forced ventilated

	g ₁ [mm]	n ₃ [mm]	n ₄ [mm]	n ₆ [mm]	m ₃ [mm]	m ₄ [mm]	m ₆ [mm]	v [°]	w [°]
MDFKS□□071-03	102	28	28	28	40	40	40	195	80
MDFKS□□071-13									
MDFKS□□071-33									

	d k6 [mm]	d ₂ [mm]	l [mm]	l ₁ [mm]	l ₂ [mm]	u [mm]	t [mm]
MDFKS□□071	19	M6	40	2.0	36	6.0	21.5

		a ₂ [mm]	a ₃ [mm]	b ₂ j6 [mm]	c ₂ [mm]	e ₂ [mm]	f ₂ [mm]	s ₂ [mm]
MDFKS□□071	FF130	160	130	110	9	130	3.5	9.0
	FT130							M8

MD□KS synchronous servo motors

Technical data





Permanent magnet holding brake

The synchronous servo motor can be fitted with integral permanent magnet holding brakes.

In the case of permanent magnet brakes, the rated torque applies solely as holding torque at standstill. This is due to the nature of their design. During braking from full motor speed, e.g. in the event of emergency stops, the braking torque is significantly reduced.

As such, they may not be used as safety elements (particularly with lifting axes) without additional measures being implemented.

The brakes are activated when the supply voltage is disconnected (closed-circuit principle). When using the brakes purely as holding brakes, virtually no wear occurs on the friction surfaces.

For traversing axes, adherence to the permissible load/brake motor (J_L / J_{MB}) moment of inertia ensures that the permissible maximum switching rate of the brake will not be exceeded and at least 2,000 emergency stop functions can be performed from a speed of 3,000 rpm.

For lifting axes, the load torque resulting from the weight acts additionally. In this case the specifications for J_L / J_{MB} do not apply.

Caution:

The brakes used are not safety brakes in the sense that a reduction in torque may arise as a result of disruptive factors that cannot be influenced, e.g. oil ingress.

The ohmic voltage drop along the cable must be taken into consideration in long motor supply cables and must be compensated for by a higher voltage at the line input.

The following applies for Lenze system cables:

$$U[V] = U_B[V] + 0.08 \frac{[V]}{[A] \cdot [m]} \cdot l_{lg}[m] \cdot I_B[A]$$

If no suitable voltage (incorrect value, incorrect polarity) is applied to the brake, the brake will be applied and can be overheated and destroyed by the motor continuing to rotate.

The shortest switching times of the brakes are achieved by DC switching of the voltage. A spark suppressor is required to suppress interference and to increase the service life of the relay contacts here.



Permanent magnet holding brake



Permanent magnet holding brake

Rated data with standard braking torque

- The figures stated apply to servo motors. They only apply to geared servo motors when the servo motor is connected via a mounting flange.

	$U_{N,DC}$ ^{3,4,6)}	M_N	M_N	M_{av}	I_N ²⁾	J	t_1 ¹⁾	t_2 ¹⁾	Q_E ⁵⁾	m	J_{MB}	J_L/J_{MB}							
		20 °C	120 °C	120 °C															
	[V]	[Nm]	[Nm]	[Nm]	[A]	[kgcm ²]	[ms]	[ms]	[J]	[kg]	[kgcm ²]								
MDSKS□□056-23	24	3.30	2.50	1.20	0.50	0.38	10.0	20.0	350	0.90	1.58	43.9							
MDSKS□□056-33					0.060						2.18	31.5							
MDSKS□□056-23	205				0.060	1.58					43.9								
MDSKS□□056-33					2.18	31.5													
MDSKS□□071-03	24	12.0	11.0	5.50	0.67	1.06	20.0	29.0	400	0.80	7.06	10.5							
MDSKS□□071-13					0.080						9.06	8.20							
MDSKS□□071-33					0.080						11.1	6.70							
MDSKS□□071-03	205				0.080						7.06	10.5							
MDSKS□□071-13					0.080						9.06	8.20							
MDSKS□□071-33					0.080						11.1	6.70							
MDFKS□□071-03	24				12.0	11.0					5.50	0.67	1.06	20.0	29.0	400	0.80	7.06	10.5
MDFKS□□071-13												0.080						9.06	8.20
MDFKS□□071-33												0.080						11.1	6.70
MDFKS□□071-03	205											0.080						7.06	10.5
MDFKS□□071-13												0.080						9.06	8.20
MDFKS□□071-33												0.080						11.1	6.70

- 1) Engagement and disengagement times are valid for rated voltage ($\pm 0\%$) and protective circuit for brakes with varistor for DC switching. The times may increase without a protective circuit.
- 2) The currents are the maximum values when the brake is cold (value used for dimensioning the current supply). The values for a motor at operating temperature are considerably lower.
- 3) With 24 V DC brake: smoothed DC voltage, ripple $\leq 1\%$.
With 205 V DC brake: connection to 230 V AC through rectifier.
- 4) UR not possible in the case of a brake with a 205 V supply voltage.
- 5) Maximum switching energy per emergency stop at $n = 3000$ r/min for at least 2000 emergency stops.
- 6) Voltage tolerance: -10% to $+5\%$



Permanent magnet holding brake

Rated data with increased braking torque

- These ratings apply only for geared servo motors with integrated servo motor (without mounting flange).

	$U_{N,DC}^{3,4,6)}$	M_N	M_N	M_{av}	$I_N^{2)}$	J	$t_1^{1)}$	$t_2^{1)}$	$Q_E^{5)}$	m	J_{MB}	J_L/J_{MB}
		20 °C	120 °C	120 °C								
	[V]	[Nm]	[Nm]	[Nm]	[A]	[kgcm ²]	[ms]	[ms]	[J]	[kg]	[kgcm ²]	
MDSKS□□056-23	24	6.00	5.00	2.50	0.67	1.06	20.0	29.0	400	5.30	2.26	34.9
MDSKS□□056-33										6.30	2.86	27.3
MDSKS□□056-23	205	6.00	5.00	2.50	0.80	1.06	20.0	29.0	400	5.30	2.26	34.9
MDSKS□□056-33										6.30	2.86	27.3
MDSKS□□071-03	24	15.0	12.0	6.00	0.75	3.60	13.0	30.0	700	8.90	9.60	10.6
MDSKS□□071-13										10.9	11.6	8.80
MDSKS□□071-33										13.0	13.6	7.50
MDSKS□□071-03	205	15.0	12.0	6.00	0.090	3.60	13.0	30.0	700	8.90	9.60	10.6
MDSKS□□071-13										10.9	11.6	8.80
MDSKS□□071-33										13.0	13.6	7.50
MDFKS□□071-03	24	15.0	12.0	6.00	0.75	3.60	13.0	30.0	700	10.2	9.60	10.6
MDFKS□□071-13										12.2	11.6	8.80
MDFKS□□071-33										13.6	7.50	
MDFKS□□071-03	205	15.0	12.0	6.00	0.090	3.60	13.0	30.0	700	10.2	9.60	10.6
MDFKS□□071-13										12.2	11.6	8.80
MDFKS□□071-33										13.6	7.50	

- 1) Engagement and disengagement times are valid for rated voltage ($\pm 0\%$) and protective circuit for brakes with varistor for DC switching. The times may increase without a protective circuit.
- 2) The currents are the maximum values when the brake is cold (value used for dimensioning the current supply). The values for a motor at operating temperature are considerably lower.
- 3) With 24 V DC brake: smoothed DC voltage, ripple $\leq 1\%$.
With 205 V DC brake: connection to 230 V AC through rectifier.
- 4) UR not possible in the case of a brake with a 205 V supply voltage.
- 5) Maximum switching energy per emergency stop at $n = 3000$ r/min for at least 2000 emergency stops.
- 6) Voltage tolerance: -10% to +5%



Resolver

Stator-fed resolver with two stator windings offset by 90° and one rotor winding with transformer winding.

Built-on accessories			RS	BS
	1)		RS0	RV03
Product key				
Resolution				
Angle		[°]	0.80	
Accuracy		[°]	-10 ... 10	
Absolute positioning			1 revolution	
Max. speed	n_{max}	[r/min]	8000	
Max. input voltage	$U_{in,max}$	[V]	10.0	
Max. input frequency	$f_{in,max}$	[kHz]	4.00	
Ratio		± 5 %	0.30	
Rotor impedance	Z_{ro}	[Ω]	51 + j90	
Stator impedance	Z_{so}	[Ω]	102 + j150	
Impedance	Z_{rs}	[Ω]	44 + j76	
Min. insulation resistance	R	[MΩ]	10.0	
At DC 500 V				
Number of pole pairs			1	
Max. angle error		[°]	-10 ... 10	
Inverter assignment			i700 E84AVTC E94A ECS EVS93	E84AVTC E94A ECS EVS93

1) 6 - Product key > built-on accessories

Speed-dependent safety functions

Suitable for safety function			No	Yes
Max. permissible angular acceleration				
MDxKS056 ... MDxKS071 2)	α	[rad/s ²]		17 000
Functional safety				
IEC 61508				SIL3
EN 13849-1				Up to Performance Level e

2) 9 - Single encoder concepts with resolvers



Incremental encoder and SinCos absolute value encoder

Encoder type			SinCos absolute value			
Built-on accessories			AG BA			
	-1)		AS1024-8V-H	AS1024-8V-K2	AM1024-8V-H	AM1024-8V-K2
Encoder type			Single-turn		Multi-turn	
Pulses			1024			
Output signals			1 Vss			
Interfaces			Hiperface			
Absolute revolutions			1		4096	
Resolution			0.40			
Angle ¹⁾		[°]	0.40			
Accuracy			-0.8 ... 0.8			
Min. input voltage			7.00			
DC	$U_{in,min}$	[V]	7.00			
Max. input voltage			12.0			
DC	$U_{in,max}$	[V]	12.0			
Max. speed			6000			
	n_{max}	[r/min]	6000			
Max. current consumption			0.080			
	I_{max}	[A]	0.080			
Limit frequency			200			
	f_{max}	[kHz]	200			
Inverter assignment			E84AVTC E94A ECS EVS93			

¹⁾ Inverter-dependent.

Speed-dependent safety functions

Suitable for safety function			No	Yes	No	Yes
Max. permissible angular acceleration						
MDxKS056 ... MDxKS071	α	[rad/s ²]		240 000		240 000
Functional safety				SIL2		SIL2
IEC 61508				Up to Performance Level d		Up to Performance Level d
EN 13849-1				Up to Performance Level d		Up to Performance Level d

MD□KS synchronous servo motors

Accessories



Blower

Rated data for 50 Hz

		Degree of protection	Number of phases	U_{min}	U_{max}	$U_{N, AC}$	P_N	I_N
				[V]	[V]	[V]	[kW]	[A]
MDFKS□□071	F10	IP54	1	210	240	230	0.019	0.12

Rated data for 60 Hz

		Degree of protection	Number of phases	U_{min}	U_{max}	$U_{N, AC}$	P_N	I_N
				[V]	[V]	[V]	[kW]	[A]
MDFKS□□071	F10	IP54	1	210	240	230	0.019	0.12



Temperature monitoring

The thermal sensors (1x KTY 83-110) used continuously monitor the motor temperature. The temperature signal is transmitted over the system cable of the feedback system to the servo controller. This means that the temperature of the motor is determined with great accuracy in the permitted operating range and at the same time the overtemperature response configured in the controller is executed in the event of overtemperature in one of the winding phases.

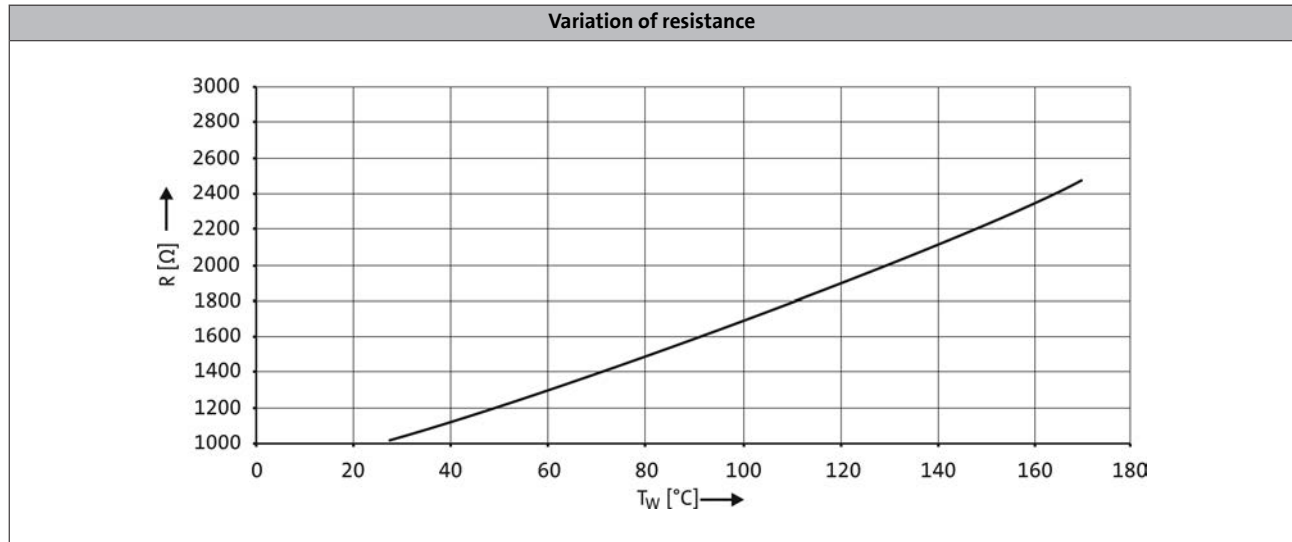

- If the thermal sensor is supplied with a measurement current of 1 mA, the above relationship between the temperature and the resistance applies.

MD□KS synchronous servo motors

Accessories



Terminal box

If a servo motor is to be connected to an existing cable or plug connectors are not to be used for other reasons, the connection can also be made via a terminal box.

The motor can either be fitted with a terminal box for the power connection and motor holding brake or a second terminal box provided to connect the motor feedback and blower (if applicable).

Connections

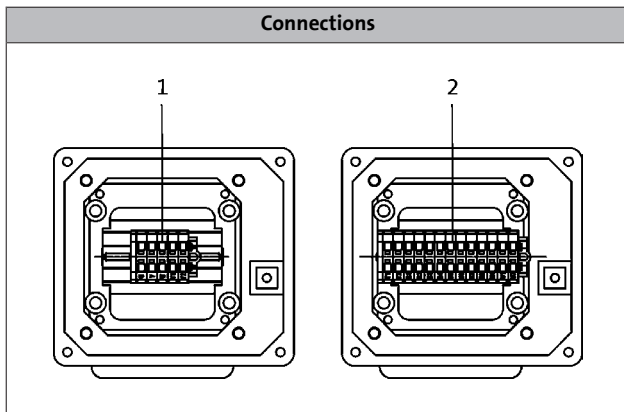

1: Power connection + brake connection + PE connection.

2: Angle/speed sensor connection + thermal sensor connection

5.3



MD□KS synchronous servo motors with blower and terminal box



Terminal box

Dimensions

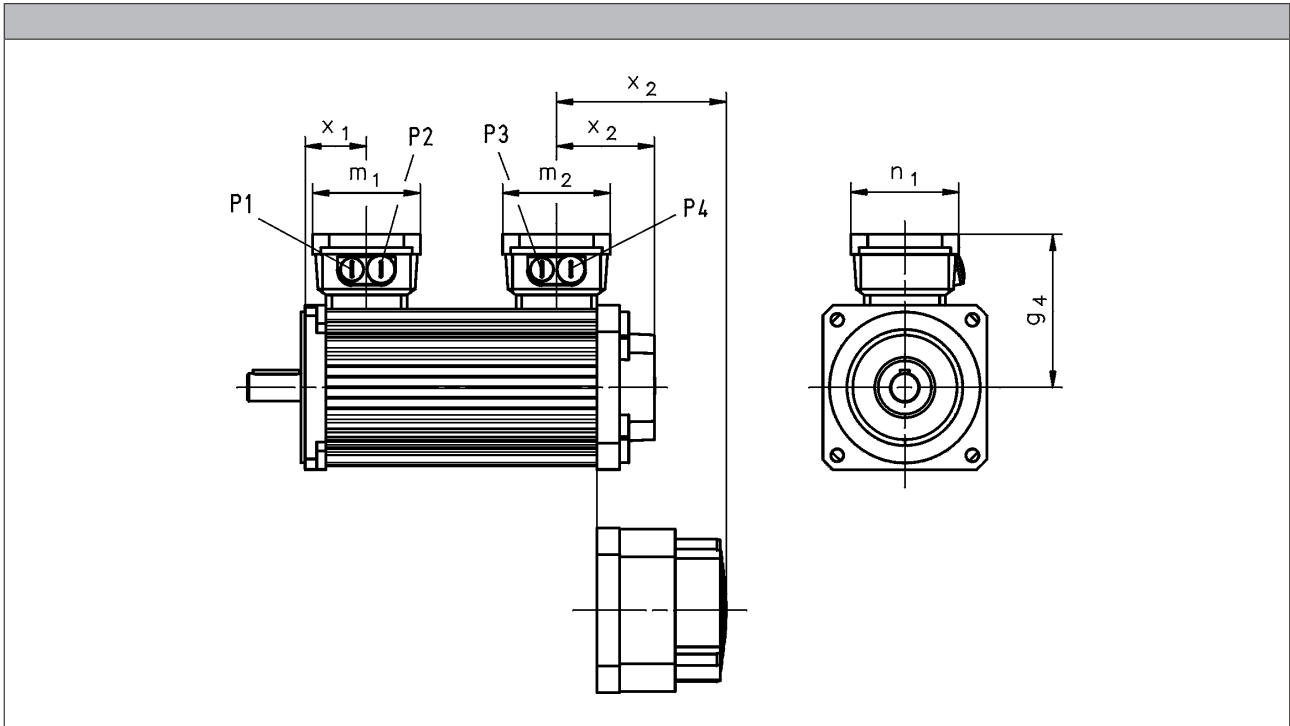

			MDSKS□□056-23	MDSKS□□056-33	MDSKS□□071-03	MDSKS□□071-13	MDSKS□□071-33
RS	x_2	[mm]	63	78	62	77	
BS	x_2	[mm]	78		77		
AG / IG	x_2	[mm]	117	132	116	131	
BA / IG	x_2	[mm]	132		131		

			MDFKS□□071-03	MDFKS□□071-13	MDFKS□□071-33
RS	x_2	[mm]	130	145	
BS	x_2	[mm]	145		
AG / IG	x_2	[mm]	184	199	
BA / IG	x_2	[mm]	199		

	g_4	m_1	m_2	n_1	x_1	P_1	P_2	P_3	P_4
	[mm]	[mm]	[mm]	[mm]	[mm]	[mm]	[mm]	[mm]	[mm]
MDSKS□□056	113	93	93	93	54	M20x1.5	M20x1.5	M20x1.5	M20x1.5
MDSKS□□071	125				57				
MDFKS□□071									

MD□KS synchronous servo motors



Accessories

ICN connector

An ICN connector is used as standard for the electrical connection to the servo motors.

A connector is used for the connection of motor and brake. The connections to the feedback system/temperature monitoring and the blower each employ a separate connector.

The connectors can be rotated through 270° and are fitted with a bayonet catch for SpeedTec connectors. As the connector fixing is also compatible with conventional union nuts. Existing mating connectors can therefore still be used without difficulty.

Connection for power and brake

Pin assignment		
Contact	Designation	Meaning
1	BD1	Holding brake +
2	BD2	Holding brake -
PE	PE	PE conductor
4	U	Phase U power
5	V	Phase V power
6	W	Phase W power

Blower connection

Pin assignment		
Contact	Designation	Meaning
PE	PE	PE conductor
1	U1	Fan
2	U2	
3		Not assigned
4		
5		
6		



ICN connector

Feedback connection

► Resolver

Pin assignment		
Contact	Designation	Meaning
1	+Ref	Transformer windings
2	-Ref	
3	+VCC ETS	Supply: Electronic nameplate
4	+COS	Cosine stator windings
5	-COS	
6	+SIN	Sine stator windings
7	-SIN	
8		Not assigned
9		
10		
11	+KTY	KTY temperature sensor
12	-KTY	

► Hiperface incremental encoder and SinCos absolute value encoder

Pin assignment		
Contact	Designation	Meaning
1	B	Track B/+SIN
2	A ⁻	Track A inverse/-COS
3	A	Track A/+COS
4	+U _B	Supply +
5	GND	Mass
6	Z ⁻	Zero track inverse/-RS485
7	Z	Zero track/+RS485
8		Not assigned
9	B ⁻	Track B inverse/-SIN
10		Not assigned
11	+KTY	KTY temperature sensor
12	-KTY	

MD□KS synchronous servo motors

Accessories



MD□KS synchronous servo motors

Accessories



MD□KS synchronous servo motors

Accessories



Motors

MQA asynchronous servo motors

66 to 1,100 Nm

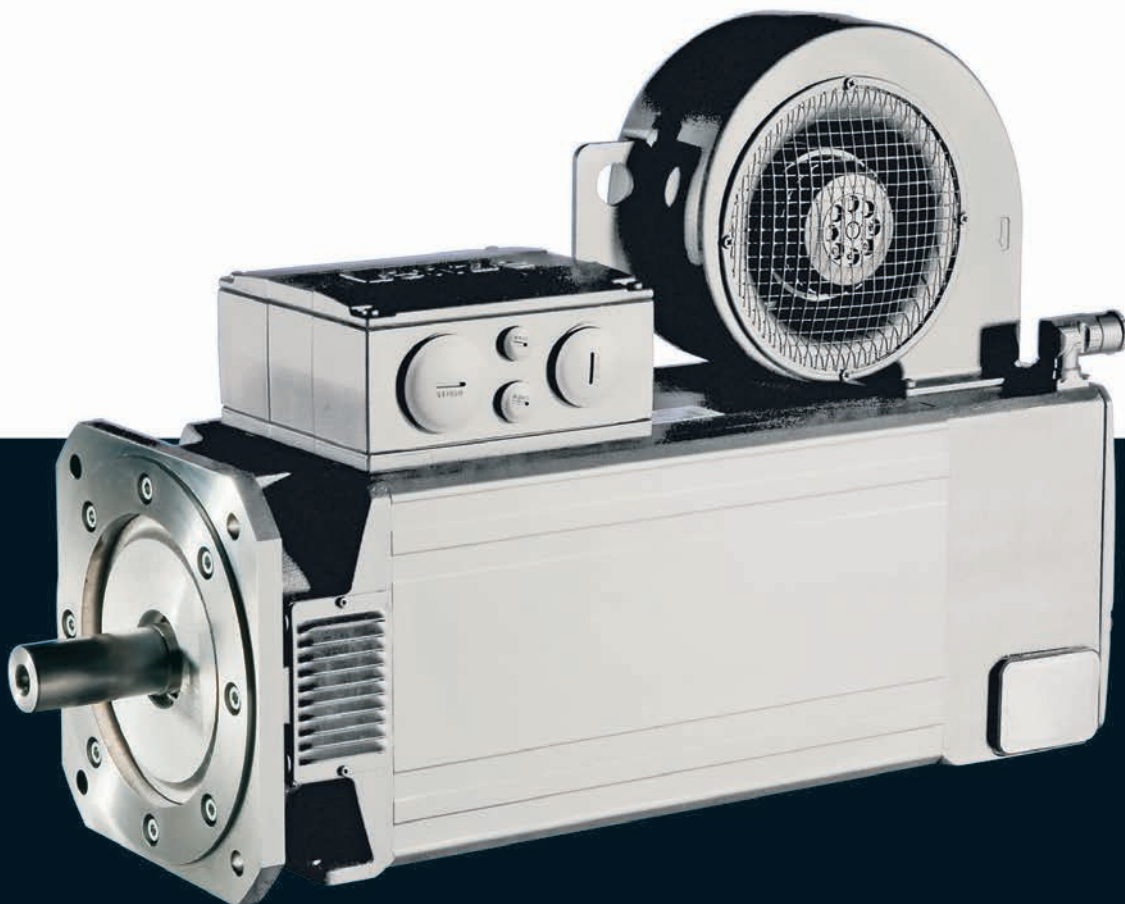

MQA asynchronous servo motors

Contents



General information	List of abbreviations	5.4 - 4
	Product key	5.4 - 6
	Product information	5.4 - 8
	Functions and features	5.4 - 9
	Dimensioning	5.4 - 10
Technical data	Standards and operating conditions	5.4 - 17
	Permissible radial and axial forces	5.4 - 18
	Rated data, forced ventilated	5.4 - 20
	Selection tables, Servo Drives 9400 HighLine	5.4 - 21
	Selection tables, Inverter Drives 8400 TopLine	5.4 - 23
	Selection tables, Servo Inverter 9300	5.4 - 25
	Torque characteristics	5.4 - 27
	Dimensions, forced ventilated	5.4 - 32
Accessories	Spring-applied holding brake	5.4 - 37
	Resolver	5.4 - 39
	Incremental encoder and SinCos absolute value encoder	5.4 - 40
	Blower	5.4 - 42
	Temperature monitoring	5.4 - 43
	ICN connector	5.4 - 44



List of abbreviations

$\eta_{100\%}$	[%]	Efficiency
$\cos \phi$		Power factor
du/dt	[kV/ μ s]	Insulation resistance
$F_{ax,-}$	[N]	Min. axial force
$F_{ax,+}$	[N]	Max. axial force
$f_{in,max}$	[Hz]	Max. input frequency
f_{max}	[kHz]	Limit frequency
f_{max}	[kHz]	Max. switching frequency
f_N	[Hz]	Rated frequency
F_{rad}	[N]	Max. radial force
H_{max}	[m]	Site altitude
I_0	[A]	Standstill current
I_{max}	[A]	Max. short-time DC-bus current
I_{max}	[A]	Max. current
I_{max}	[A]	Max. current consumption
I_{max}	[A]	Max. current
I_{max}	[A]	Max. DC-bus current
I_N	[A]	Rated current
J	[kgcm ²]	Moment of inertia
J_{MB}	[kgcm ²]	Moment of inertia
$KE_{LL\ 150\ ^\circ C}$	[V / (1000 r/min)]	Voltage constant
$Kt_{0\ 150\ ^\circ C}$	[Nm/A]	Torque constant
L	[mH]	Mutual inductance
$L_{1\sigma}$	[mH]	Stator leakage inductance
$L_{2\sigma}$	[mH]	Rotor leakage inductance
L_N	[mH]	Rated inductance
m	[kg]	Mass
M_0	[Nm]	Stall torque
$M_{0,max}$	[Nm]	Max. standstill torque
M_{av}	[Nm]	Average dynamic torque
M_{max}	[Nm]	Max. torque
M_N	[Nm]	Rated torque
n_{eto}	[r/min]	Transition speed
n_k	[r/min]	Speed
n_{max}	[r/min]	Max. speed

n_N	[r/min]	Rated speed
P_N	[kW]	Rated power
Q_E	[J]	Maximum switching energy
R	[Ω]	Insulation resistance
R	[Ω]	Min. insulation resistance
R_1	[Ω]	Stator impedance
R_2	[Ω]	Charging resistor
R_2	[Ω]	Rotor impedance
$R_{UV\ 150\ ^\circ C}$	[Ω]	Stator impedance
$R_{UV\ 20\ ^\circ C}$	[Ω]	Stator impedance
$S_{h\u00fc}$	[1/h]	Transition operating frequency
T	[$^\circ C$]	Operating temperature
T	[$^\circ C$]	Rated temperature
T	[$^\circ C$]	Max. ambient temperature of bearing
T	[$^\circ C$]	Max. surface temperature
T	[$^\circ C$]	Max. ambient temperature for transport
T	[$^\circ C$]	Min. ambient storage temperature
T	[$^\circ C$]	Min. ambient temperature for transport
T	[$^\circ C$]	Ambient temperature
t_1	[ms]	Engagement time
t_2	[ms]	Disengagement time
$T_{opr,max}$	[$^\circ C$]	Max. ambient operating temperature
$T_{opr,min}$	[$^\circ C$]	Min. ambient operating temperature
$U_{in,max}$	[V]	Max. input voltage
$U_{in,min}$	[V]	Min. input voltage
U_{max}	[V]	Max. mains voltage
U_{max}	[V]	Min. input voltage
U_{min}	[V]	Min. mains voltage
$U_{N, AC}$	[V]	Rated voltage
$U_{N, DC}$	[V]	Rated voltage
Z_{ro}	[Ω]	Rotor impedance
Z_{rs}	[Ω]	Impedance
Z_{so}	[Ω]	Stator impedance

MQA asynchronous servo motors

General information



List of abbreviations

CE	Communauté Européenne
CSA	Canadian Standards Association
DIN	Deutsches Institut für Normung e.V.
EMC	Electromagnetic compatibility
EN	European standard
EAC	Customs union Russia / Belarus / Kazakhstan certificate
IEC	International Electrotechnical Commission
IM	International Mounting Code
IP	International Protection Code
NEMA	National Electrical Manufacturers Association
UkrSEPRO	Certificate for Ukraine
UL	Underwriters Laboratory Listed Product
UR	Underwriters Laboratory Recognized Product
VDE	Verband deutscher Elektrotechniker (Association of German Electrical Engineers)

MQA asynchronous servo motors

General information



Product key

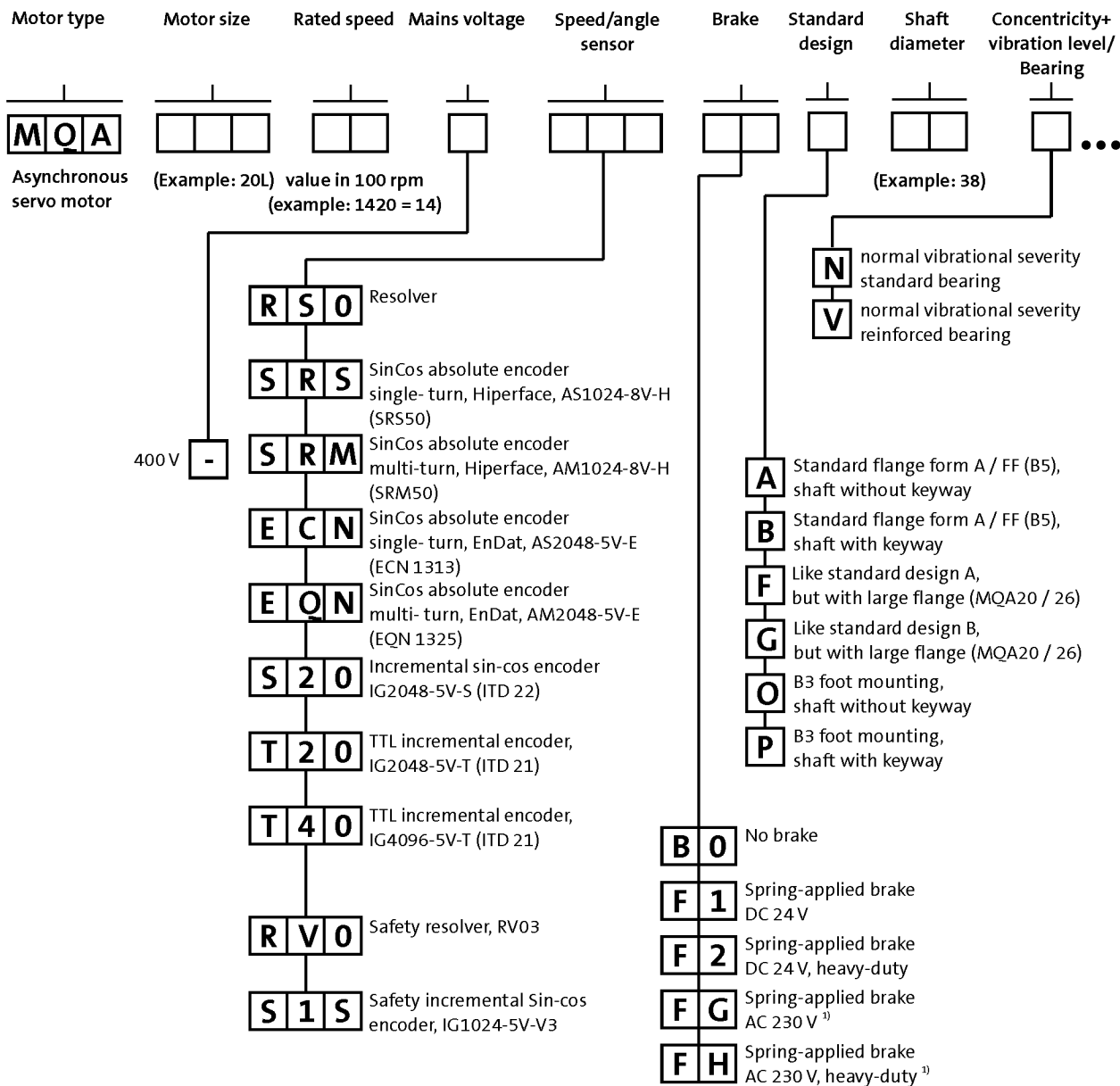

5.4

¹⁾ Not possible for UL design.

MQA asynchronous servo motors

General information

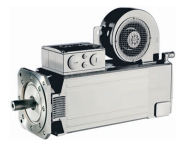

Product key

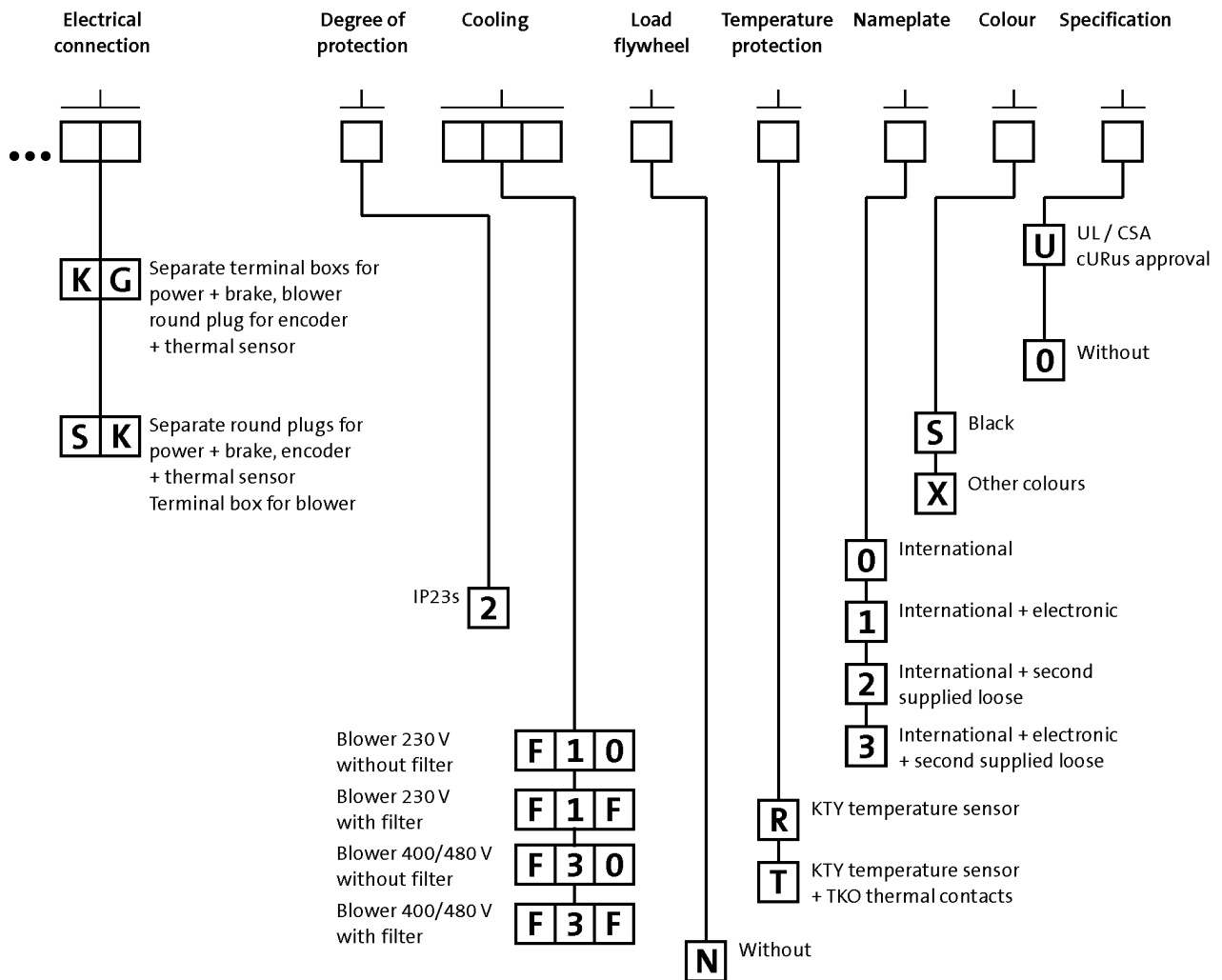

MQA asynchronous servo motors

General information



Product information

Designed for the harsh conditions of continuous operation in tight spaces at high torques, the enclosed-ventilated motors in the MDFQA series offer a long service life and optimum operational performance in all drive situations.

The motors, which have a power range of between 10 kW and 95 kW, are compact units with IP23 degree of protection. They have been designed specifically for operation with Lenze's frequency and servo inverters.

A wide range of feedback systems, brakes and blowers ensures that the perfect system configuration is available for virtually all operating conditions.

Advantages

- High power density
- Excellent operating characteristics
- IP23 protection
- Easy to install and service friendly
 - MQA 20 with SpeedTec connectors
 - MQA 22 and 26 with three-part terminal box
- Temperature class F
- KTY temperature monitoring
- Radial external fan
- B3 or B35 design
- Wide speed control range
- Field weakening operation usable

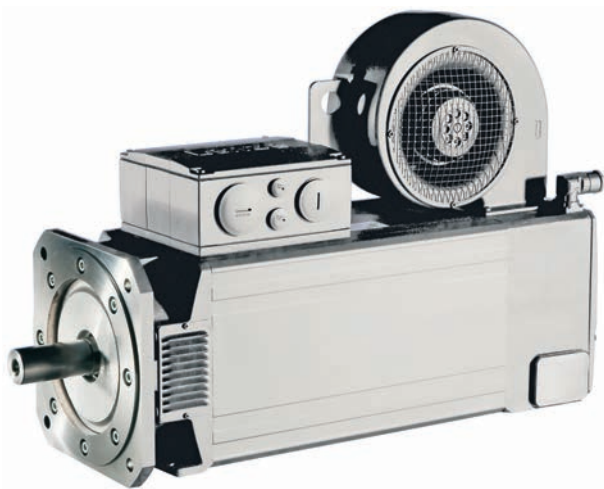

MQA22 asynchronous servo motor

MQA asynchronous servo motors

General information

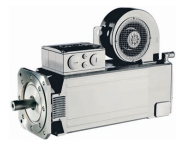

Functions and features

	MQA20	MQA22	MQA26
Design			
	B3 B35-FF215 B35-FF265	B3 B35-FF265	B3 B35-FF265 B35-FF350
Shaft end (with and without keyway)	38 x 80		55 x 110
A end shield	Oil-tight Not oil-tight		
Brake			
Spring-applied brake	DC 24 V AC 230 V ^{1, 2)}		
Speed and angle encoder			
	Resolver SinCos single-turn/multi-turn Incremental encoder		
Cooling			
Radial blower, 1 phase	230 V; 50 Hz 230 V; 60 Hz		
Radial blower, 3 phase	400 V; 50 Hz 400 V; 60 Hz 460 V; 50 Hz 460 V; 60 Hz 480 V; 60 Hz		
Temperature sensor			
Thermal detector	KTY		
Thermal contact	TKO ³⁾		
Motor connection: Terminal box + plug connector			
Terminal box	Power + brake Blower		
Plug connector	Power + brake Encoder + thermal sensor	Encoder + thermal sensor	
Shaft bearings			
Bearing type	Deep-groove ball bearing with high-temperature resistant grease, sealing disc or cover plate		
Position of the locating bearing	Non-drive end		
Installation of the locating bearing	insulation		
Colour			
	Primed (grey) RAL9005M		

¹⁾ Not possible for UR version.

²⁾ Not possible for MQA motor type with circular connector for motor connection.

³⁾ Not possible for MQA motor type with circular connector for motor connection and brake.

MQA asynchronous servo motors

General information



Dimensioning

Speed-dependent safety functions

Single encoder concepts with resolvers

Servo motors can perform speed-dependent safety functions for safe speed and / or safe relative position monitoring in a drive system with the Servo Drives 9400. The SM301 safety module, which can be integrated in the Servo Drives 9400, is used to implement these functions. When planning systems/installations of this kind, the following must always be observed:

When using just one single feedback system in the environment of these safety applications, the applicable safety engineering standard IEC 61800-5-2 [Adjustable speed electrical power drive systems - Part: 5-2: Safety requirements - Functional] stipulates special requirements for the connection between feedback system and motor shaft. This is due to the fact that two-channel safety systems at this point in the mechanical system are actually designed as single-channel systems. If this mechanical connection is designed with considerable overdimensioning, the standard permits exclusion of the fault "encoder-shaft breakage" or "encoder-shaft slip". As such, acceleration limit values must not be exceeded for the individual drive solutions. You can find the limit values in the corresponding feedback data of the individual motor ranges.

Speed-dependent safety functions in connection with the SM301 safety module

For the following speed-dependent safety functions, the motor-feedback system combinations listed in the following table are available:

- Safe stop 1 (SS1)
- Safe operational stop (SOS)
- Safely Limited Speed (SLS)
- Safe Maximum Speed (SMS)
- Safe direction (SDI)
- Operation mode selector (OMS) with confirmation (ES)
- Safe speed monitor (SSM)
- Safely limited increment (SLI).

Encoder type	Encoder type	Product key	Feedback Design	Safe speed monitoring
SinCos incremental	Single-turn	IG1024-5V-V3	2-encoder concept	PL e/SIL 3 up to PL e / SIL 3
Resolver		RV03		

MQA asynchronous servo motors

General information



Dimensioning

Cooling effect of mounting flange

Mounting on a thermally conducting / insulating plate or machine chassis only has a minor impact in terms of heating up the motor when using servo motors from the MQA range. As such, this effect is negligible and can be disregarded.

Vibrational severity

		MQA20	MQA22	MQA26
Vibrational severity				
IEC/EN 60034-14			A	
Maximum r.m.s. value of the vibration velocity ¹⁾	[mm/s]		1.60	

¹⁾ Free suspension

- ▶ at n = 600 to 3,600 rpm



Dimensioning

Concentricity and axial run-out of the mounting flanges and smooth running of the shaft ends

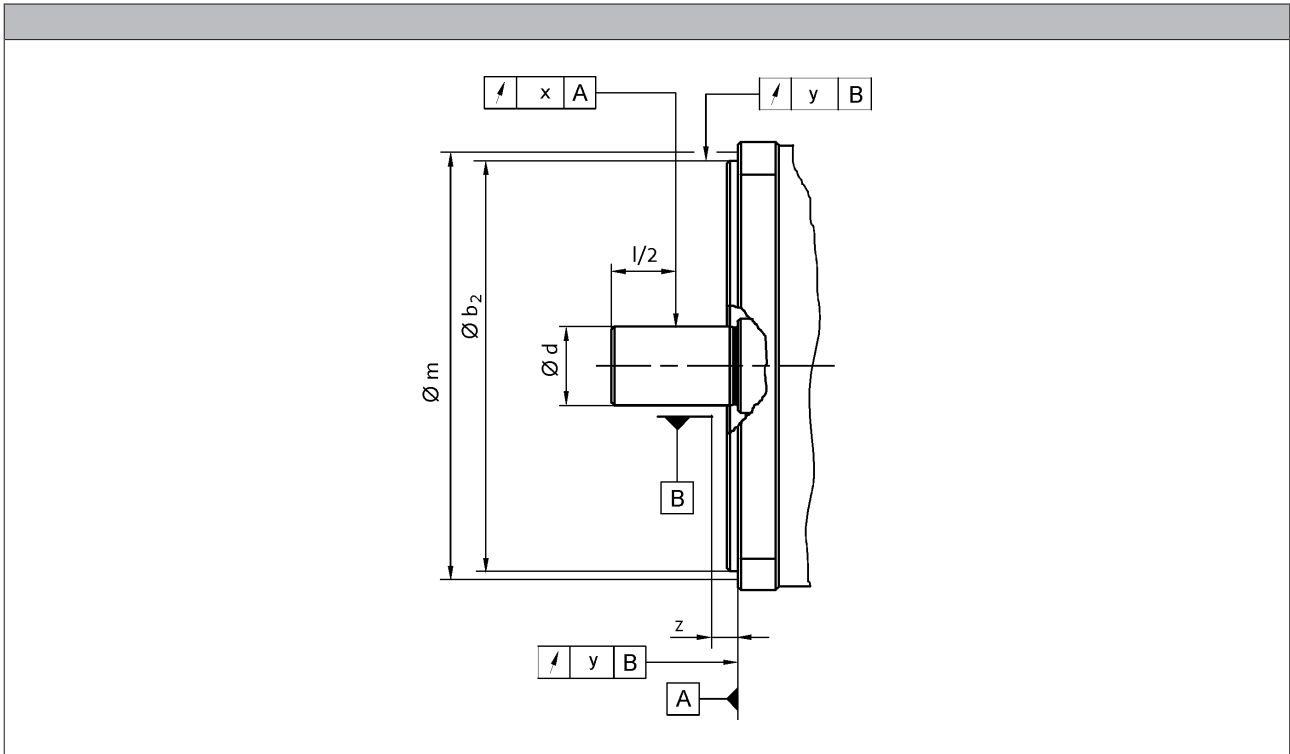

5.4

				MQA20	MQA22	MQA26
Flange size				FF215	FF265	FF350
Dimensions						
	b_2	j6	[mm]	180	230	
	b_2	h6	[mm]			300
	d	k6	[mm]	38		
	d	m6	[mm]			55
Distance						
Measuring diameter	m		[mm]	239	289	384
Dial gauge holder for flange check	z	+/- 1	[mm]	10.0		
Concentricity						
IEC 60072				Normal class		
Value	y		[mm]	0.10		
Axial run-out						
IEC 60072				Normal class		
Value	y		[mm]	0.10		
Smooth running						
IEC 60072				Normal class		
Value	x		[mm]	0.050		0.060

- Limit values for checking the smooth running of the shaft ends as well as the concentricity and axial run-out of the mounting flange to IEC 60072

MQA asynchronous servo motors

General information



Dimensioning

Notes on the selection tables

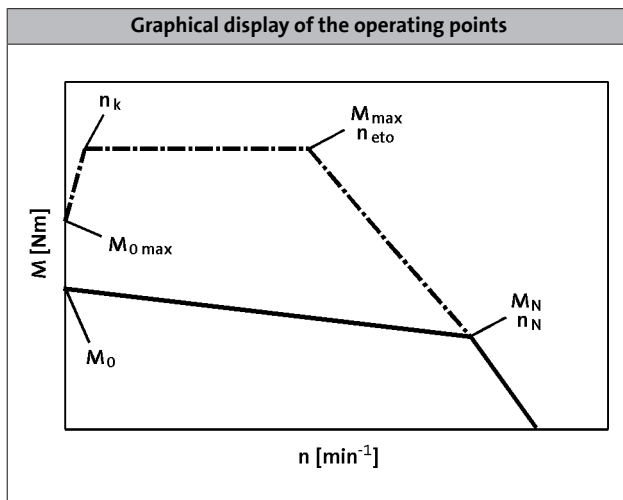

Please note:

- With an active load (e.g. vertical drive axes, hoists, test benches, unwinders), $M_{0\max}$ must be taken into account
- With a passive load (e.g. horizontal drive axes), M_{\max} can generally be used
- At speeds $< n_k$, the inverter-specific torque $M_{0\max}$ that can be achieved is lower than M_{\max}
- On the servo inverters, the switching frequency-dependent overload capacity has been taken into account in the factory settings. For further information, please refer to the Servo-Inverters catalogue.

	n_k [r/min]
MCA	150
MQA	

Further selection tables with different switching frequencies are available with the following codes:

- DS_ZT_MCS_0001
- DS_ZT_MCA_0001
- DS_ZT_MDSKS_0001
- DS_ZT_MDFKS_0001

Simply enter this code (e.g. DS_ZT_MCS_0001) as a search string at www.lenze.de/dsc and you will be given the information immediately in the form of a PDF format.



Dimensioning

Notes on the torque characteristics

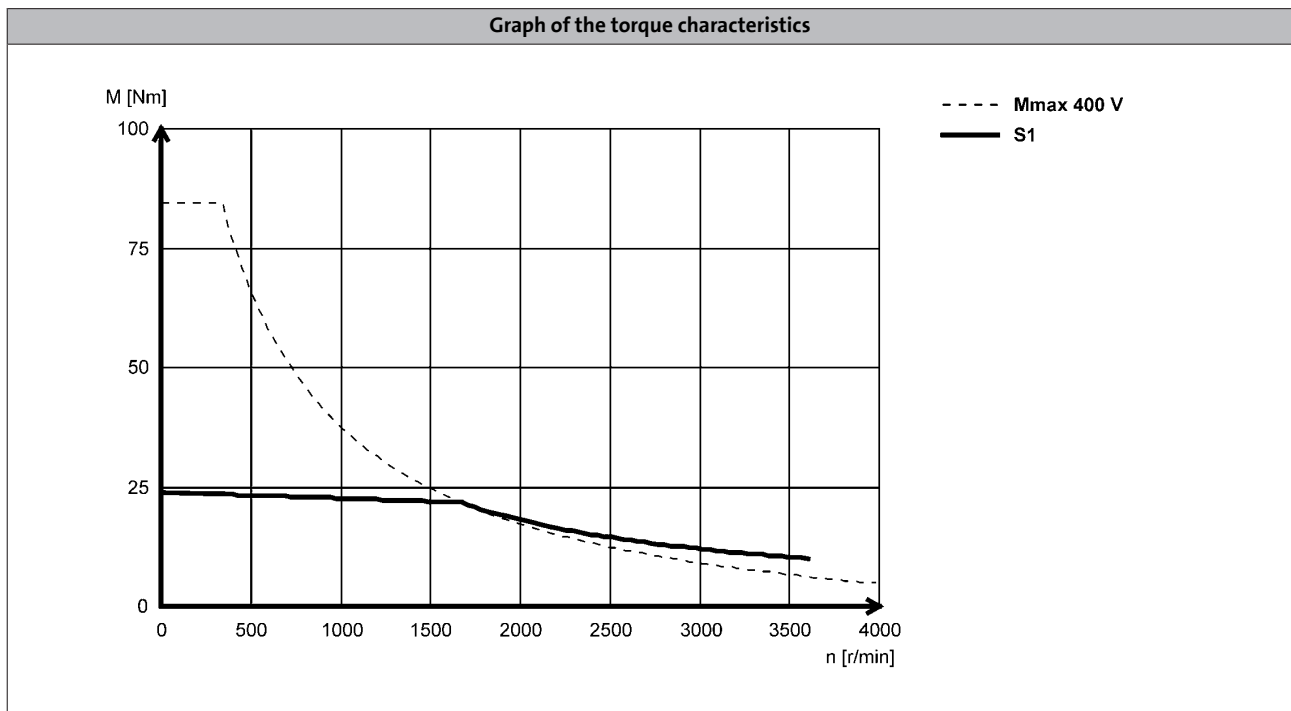

With asynchronous servo motors, two characteristics are shown in each case. The characteristics for continuous operation (S1) show the speed-dependent constant torque of the motor when operating with a servo inverter that itself is operated at a constant switching frequency. The limit torque characteristics correspond to those that come about during operation of the motor with the largest possible 9400 Servo Drive in each case (see selection tables). The servo inverter is set to a variable switching frequency here.

Characteristics in the Internet

Torque characteristics for selectable motor/inverter combinations can be determined in the EASY Product Finder in the Internet. The S1 continuous characteristic and the max. limit characteristic are generated. The result can be saved or printed in a PDF protocol. In the EASY Explorer, available torque characteristics are provided automatically.

Further information on the terms switching frequency and default setting can be found in the respective operating instructions of the servo inverter.



Dimensioning

Influence of ambient temperature and site altitude

The information relating to the servo motors in the tables and graphs is valid for a maximum ambient temperature (T_{opr}) of 40 °C and a site altitude (H) up to 1000 m above sea level. The torque correction factor (k_{M1}) shall be applied to the S1 torque characteristic ($M_0...M_N$) in the event of differing installation conditions.

- The maximum permissible ambient temperature (T_{opr}) for servo motors with blowers is 40 °C

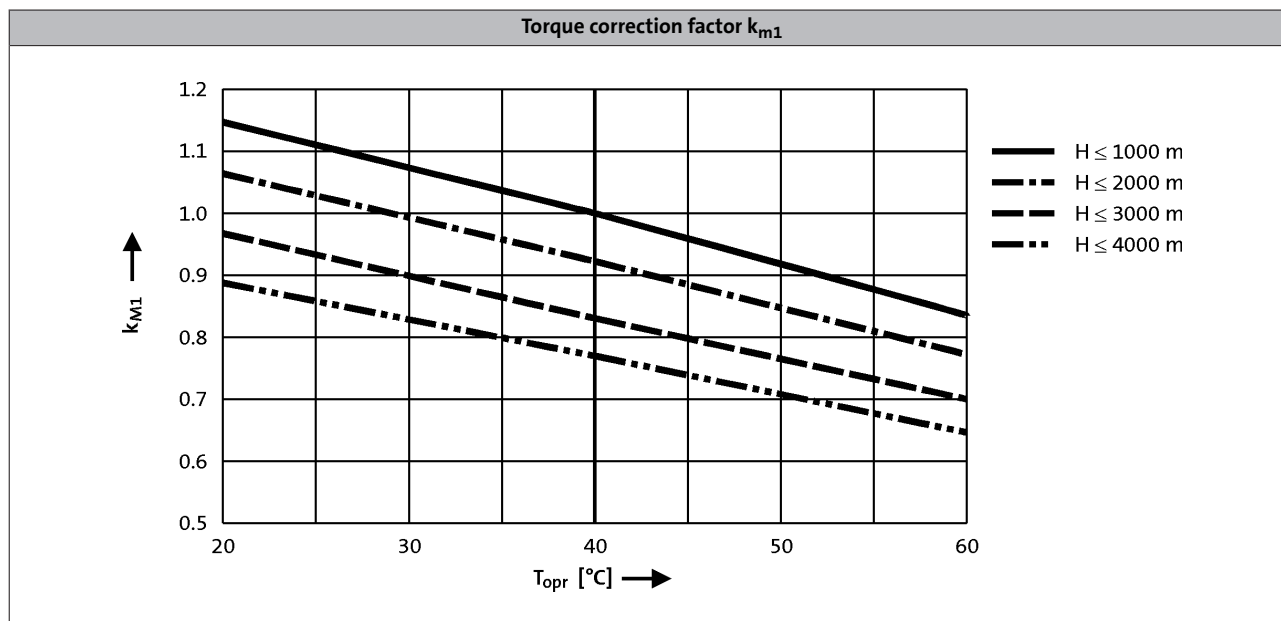

MQA asynchronous servo motors

General information



MQA asynchronous servo motors

Technical data

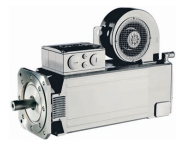

Standards and operating conditions

			MQA
Cooling type			Blower
Degree of protection			IP23s
EN 60529			
Temperature class			F
IEC/EN 60034-1; utilisation			
IEC/EN 60034-1; insulation system (enamel-insulated wire)			H
Conformity			
CE			Low-Voltage Directive 2006/95/EC
EAC			TP TC 004/2011 (TR CU 004/2011)
Approval			
CSA			UkrSEPRO CSA 22.2 No. 100
cURus ¹⁾			UL 1004-1 UL 1004-6 Power Conversion Equipment (File-No. E210321)
Max. voltage load			
IEC/TS 60034-25			Pulse voltage limiting curve A
Smooth running			
IEC 60072			Normal class
Axial run-out			
IEC 60072			Normal class
Concentricity			
IEC 60072			Normal class
Mechanical ambient conditions (vibration)			
IEC/EN 60721-3-3			3M6
Min. ambient operating temperature			
Without brake	$T_{opr,min}$	[°C]	-15
With brake	$T_{opr,min}$	[°C]	-10
Max. ambient operating temperature			
	$T_{opr,max}$	[°C]	40
Max. surface temperature			
	T	[°C]	110
Mechanical tolerance			
Flange centring diameter			$b_2 \leq 230 \text{ mm} = j6$ $b_2 > 230 \text{ mm} = h6$
Shaft diameter			$d \leq 50 \text{ mm} = k6$ $d > 50 \text{ mm} = m6$
Site altitude			
Amsl	H_{max}	[m]	4000

¹⁾ MQA20L29 with circular connector for motor connection only UR



Permissible radial and axial forces

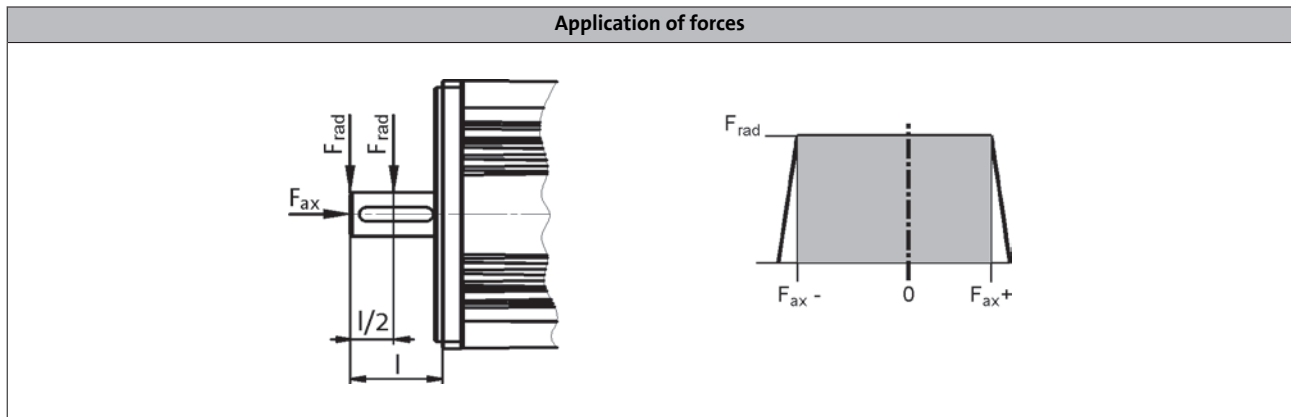

Application of force at l/2

	Bearing service life L_{10}														
	5000 h			10000 h			20000 h			30000 h			50000 h		
	F_{rad}	$F_{ax,-}$	$F_{ax,+}$	F_{rad}	$F_{ax,-}$	$F_{ax,+}$	F_{rad}	$F_{ax,-}$	$F_{ax,+}$	F_{rad}	$F_{ax,-}$	$F_{ax,+}$	F_{rad}	$F_{ax,-}$	$F_{ax,+}$
	[N]	[N]	[N]	[N]	[N]	[N]	[N]	[N]	[N]	[N]	[N]	[N]	[N]	[N]	[N]
MQA20	3400	-1330	690	2500	-1020	380	1950	-780	140	1700	-690	40			
MQA22	3600	-2370	1700	2800	-1740	1090	2200	-1280	640	1900	-1080	440	1600	-880	240
MQA26	6950	-2500	1580	5400	-1800	880	4300	-1300	380	3700	-1090	160			

Application of force at l

	Bearing service life L_{10}														
	5000 h			10000 h			20000 h			30000 h			50000 h		
	F_{rad}	$F_{ax,-}$	$F_{ax,+}$	F_{rad}	$F_{ax,-}$	$F_{ax,+}$	F_{rad}	$F_{ax,-}$	$F_{ax,+}$	F_{rad}	$F_{ax,-}$	$F_{ax,+}$	F_{rad}	$F_{ax,-}$	$F_{ax,+}$
	[N]	[N]	[N]	[N]	[N]	[N]	[N]	[N]	[N]	[N]	[N]	[N]	[N]	[N]	[N]
MQA20	3150	-1170	530	2300	-920	280	1800	-710	70	1400	-650	0			
MQA22	3500	-2240	1600	2600	-1640	1100	2050	-1200	560	1800	-1020	380	1450	-850	200
MQA26	6400	-2080	1150	5000	-1600	680	4000	-1160	230	3400	-1090	50			

- The values for the bearing service life L_{10} refer to an average speed of 3000 r/min. Depending on the ambient temperatures, the service life of the bearings is also reduced by the grease life-time.



Permissible radial and axial forces

- Reinforced bearings

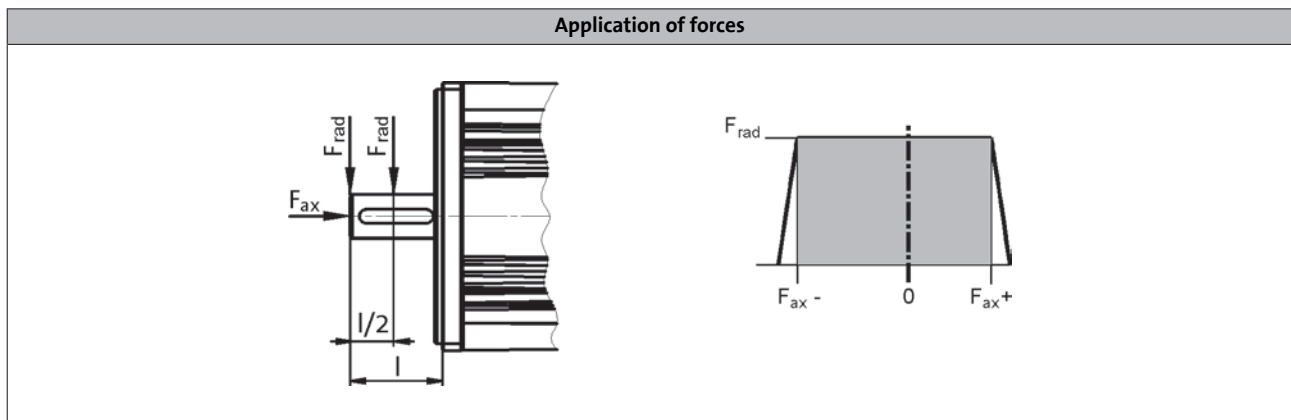

Application of force at $l/2$

	Bearing service life L_{10}														
	5000 h			10000 h			20000 h			30000 h			50000 h		
	F_{rad}	$F_{ax,-}$	$F_{ax,+}$	F_{rad}	$F_{ax,-}$	$F_{ax,+}$	F_{rad}	$F_{ax,-}$	$F_{ax,+}$	F_{rad}	$F_{ax,-}$	$F_{ax,+}$	F_{rad}	$F_{ax,-}$	$F_{ax,+}$
	[N]	[N]	[N]	[N]	[N]	[N]	[N]	[N]	[N]	[N]	[N]	[N]	[N]	[N]	[N]
MQA20	7100	-970	330	5100	-800	160	3900	-640	0						
MQA22	8500	-1850	1200	7000	-1400	760	5600	-1030	390	4350	-930	290	3200	-800	160
MQA26	10500	-2180	1250	8370	-1530	600	6670	-1130	200	5840	-960	30			

Application of force at l

	Bearing service life L_{10}														
	5000 h			10000 h			20000 h			30000 h			50000 h		
	F_{rad}	$F_{ax,-}$	$F_{ax,+}$	F_{rad}	$F_{ax,-}$	$F_{ax,+}$	F_{rad}	$F_{ax,-}$	$F_{ax,+}$	F_{rad}	$F_{ax,-}$	$F_{ax,+}$	F_{rad}	$F_{ax,-}$	$F_{ax,+}$
	[N]	[N]	[N]	[N]	[N]	[N]	[N]	[N]	[N]	[N]	[N]	[N]	[N]	[N]	[N]
MQA20	6350	-720	80	4100	-680	40	2800	-640	0						
MQA22	7000	-1750	1100	5500	-1300	660	4700	-920	280	3900	-820	180	3000	-700	60
MQA26	9600	-2200	1280	7700	-1280	360	6000	-960	30						

- The values for the bearing service life L_{10} refer to an average speed of 3000 r/min. Depending on the ambient temperatures, the service life of the bearings is also reduced by the grease life-time.

MQA asynchronous servo motors

Technical data



Rated data, forced ventilated

► The data applies to a mains connection voltage of 3 x 400 V.

	n_N [r/min]	M_0 [Nm]	M_N [Nm]	M_{max} [Nm]	P_N [kW]	I_0 [A]	I_N [A]	$U_{N, AC}$ [V]	f_N [Hz]	$J^{1)}$ [kgcm ²]	$\eta_{100\%}$ [%]
MQA20L14...2F□□	1420	76.0	71.3	250	10.6	27.0	26.5	360	50	171	80.0
MQA20L29...2F□□	2930	76.0	66.2	250	20.3	54.0	46.9	360	100	171	90.0
MQA22P08...2F□□	760	156	145	500	11.5	29.5	27.6	360	28	487	77.0
MQA22P14...2F□□	1425	156	135	500	20.1	51.0	45.6	360	50	487	86.0
MQA22P17...2F□□	1670	156	130	500	22.7	59.0	50.3	360	58	487	88.0
MQA22P29...2F□□	2935	156	125	500	38.4	102	86.0	360	100	487	90.0
MQA26T05...2F□□	550	325	296	1100	17.0	48.5	44.5	360	20	1335	81.0
MQA26T10...2F□□	1030	325	288	1100	31.1	85.5	76.2	360	36	1335	87.0
MQA26T12...2F□□	1200	325	282	1100	35.4	109	88.8	360	42	1335	82.0
MQA26T22...2F□□	2235	325	257	1100	60.2	171	138	340	76	1335	92.0

	R_1 [Ω]	$R_{UV\ 20\ ^\circ C}$ [Ω]	$R_{UV\ 150\ ^\circ C}$ [Ω]	R_2 [Ω]	$L_{1\sigma}$ [mH]	L [mH]	$L_{2\sigma}$ [mH]	$n_{max}^{2)}$ [r/min]	$m^{1)}$ [kg]
MQA20L14...2F□□	0.37	0.73	1.10	0.36	1.98	57.0	2.10	6500	63.0
MQA20L29...2F□□	0.090	0.18	0.28	0.090	0.49	13.7	0.52		
MQA22P08...2F□□	0.54	1.07	1.62	0.48	3.53	92.8	4.76		
MQA22P14...2F□□		0.36	0.54		3.57	93.3	4.81		
MQA22P17...2F□□	0.13	0.27	0.40	0.12	0.90	23.9	1.21		
MQA22P29...2F□□		0.080	0.12		0.89	23.2	1.20		
MQA26T05...2F□□	0.29	0.59	0.89	0.25	2.87	70.0	5.05	5500	193
MQA26T10...2F□□		0.20	0.30		2.91	69.2	5.09		
MQA26T12...2F□□	0.080	0.15	0.23	0.060	0.78	18.1	1.30		
MQA26T22...2F□□		0.050	0.075			18.4			

¹⁾ Without brake.

²⁾ Mechanically permissible maximum speed.

The permanent speed is limited to 70% of the value

The data in the R_1 , $L_{1\sigma}$, L , R_2' and $L_{2\sigma}'$ columns is based on a single-phase equivalent circuit diagram at 20°C.

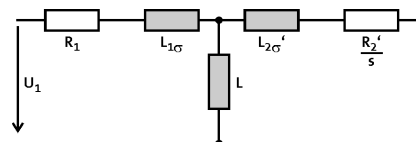

MQA asynchronous servo motors

Technical data



Selection tables, Servo Drives 9400 HighLine

Forced ventilated IP23s motors

- The data applies to a mains connection voltage of 3 x 400 V and an inverter switching frequency of 8 kHz.

					E94A□□	E0174	E0244	E0324	E0474	E0594	E0864	E1044	E1454	E1724
					I_N	16.5	23.5	32.0	41.0	41.0	73.0	78.0	102.0	120.0
					$I_{0,max}$	49.5	58.8	76.8	94.0	118.0	172.0	208.0	261.0	310.0
MQA	M_N	n_N	I_N	P_N	I_{max}	49.5	58.8	76.8	94.0	118.0	172.0	208.0	261.0	310.0
20L14-...2F□□	71.3	1420	26.5	10.60	M_0	32.5	66.0							
					M_N	32.5	66.0							
					$M_{0,max}$	154.2	190.0							
					M_{max}	154.2	190.0							
					η_{eto}	-	-							
20L29-...2F□□	66.2	2930	46.9	20.30	M_0			28.0	51.6	51.6				
					M_N			28.0	51.6	51.6				
					$M_{0,max}$			116.0	148.2	192.8				
					M_{max}			116.0	148.2	192.8				
					η_{eto}			-	-	-				
22P08-...2F□□	145.0	760	27.6	11.50	M_0		116.0	156.0						
					M_N		116.0	145.0						
					$M_{0,max}$		313.0	402.0						
					M_{max}		313.0	402.0						
					η_{eto}		-	-						
22P14-...2F□□	135.0	1425	45.6	20.10	M_0					118.0				
					M_N					118.0				
					$M_{0,max}$					372.0				
					M_{max}					372.0				
					η_{eto}					-				
22P17-...2F□□	130.0	1670	50.3	22.70	M_0					99.0	156.0			
					M_N					99.0	130.0			
					$M_{0,max}$					325.0	463.0			
					M_{max}					325.0	463.0			
					η_{eto}					-	-			
22P29-...2F□□	125.0	2935	86.0	38.40	M_0							109.0	156.0	156.0
					M_N							109.0	125.0	125.0
					$M_{0,max}$							335.0	416.0	486.0
					M_{max}							335.0	416.0	486.0
					η_{eto}							-	-	-

- $I...$ [A], $M...$ [Nm], $n...$ [r/min], $P...$ [kW]
- If the motors are operated at a lower switching frequency, please contact your Lenze sales office!
- When operating at 4 kHz, the motor generates just 95 % of its rated torque with increased noise emissions.

5.4

MQA asynchronous servo motors

Technical data



Selection tables, Servo Drives 9400 HighLine

Forced ventilated IP23s motors

- The data applies to a mains connection voltage of 3 x 400 V and an inverter switching frequency of 8 kHz.

					E94A□□	E0474	E0594	E0864	E1044	E1454	E1724	E2024	E2454	E2924	E3664
					I _N	41.0	41.0	73.0	78.0	102.0	120.0	131.0	160.0	191.0	240.0
					I _{0,max}	94.0	118.0	172.0	208.0	261.0	310.0	364.0	441.0	526.0	659.0
MQA	M _N	n _N	I _N	P _N	I _{max}	94.0	118.0	172.0	208.0	261.0	310.0	364.0	441.0	526.0	659.0
26T05-...2F□□	296.0	550	44.5	17.00	M ₀	268.0	268.0	325.0							
					M _N	268.0	268.0	296.0							
					M _{0,max}	665.0	826.0	1100.0							
					M _{max}	665.0	826.0	1100.0							
					η _{eto}	-	-	-							
26T10-...2F□□	288.0	1030	76.2	31.10	M ₀			270.0	298.0	325.0					
					M _N			270.0	288.0	288.0					
					M _{0,max}			713.0	855.0	1044.0					
					M _{max}			713.0	855.0	1044.0					
					η _{eto}			-	-	-					
26T12-...2F□□	282.0	1200	88.8	35.40	M ₀				219.0	291.0	325.0	325.0			
					M _N				219.0	282.0	282.0	282.0			
					M _{0,max}				609.0	739.0	840.0	950.0			
					M _{max}				609.0	739.0	840.0	950.0			
					η _{eto}				-	-	-	-			
26T22-...2F□□	257.0	2235	138.1	60.10	M ₀							242.0	290.0	325.0	325.0
					M _N							242.0	257.0	257.0	257.0
					M _{0,max}							711.0	843.0	1001.0	1100.0
					M _{max}							711.0	843.0	1001.0	1100.0
					η _{eto}							-	-	-	-

5.4

- I... [A], M... [Nm], n... [r/min], P... [kW]
- If the motors are operated at a lower switching frequency, please contact your Lenze sales office!
- When operating at 4 kHz, the motor generates just 95 % of its rated torque with increased noise emissions.

MQA asynchronous servo motors

Technical data

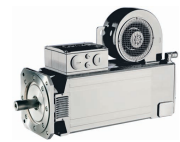

Selection tables, Inverter Drives 8400 TopLine

Forced ventilated IP23s motors

- The data applies to a mains connection voltage of 3 x 400 V and an inverter switching frequency of 8 kHz.

					E84AVTC	□1134	□1534	□1834	□2234	□3034	□3734	□4534	
					I_N	23.5	32.0	39.0	47.0	61.0	76.0	89.0	
					$I_{0,max}$	32.9	43.2	60.0	70.5	91.5	114.0	133.5	
MQA	M_N	n_N	I_N	P_N	I_{max}	47.0	64.0	78.0	94.0	122.0	152.0	178.0	
20L14-...2F□□	71.3	1420	26.5	10.60	M_0	-	76.0	76.0	76.0	76.0			
					M_N	-	71.3	71.3	71.3	71.3			
					$M_{0,max}$	146.0	202.0	249.2	250.0	250.0			
					M_{max}	146.0	202.2	249.2	250.0	250.0			
					η_{eto}	-	-	-	-	-			
20L29-...2F□□	66.2	2930	46.9	20.30	M_0			-	76.0	76.0	76.0	76.0	
					M_N			-	66.2	66.2	66.2	66.2	66.2
					$M_{0,max}$			121.8	140.9	183.7	224.5	250.0	
					M_{max}			121.8	140.9	183.9	225.5	250.0	
					η_{eto}			-	-	-	-	-	
22P08-...2F□□	145.0	760	27.6	11.50	M_0	-	156.0	156.0	156.0	156.0			
					M_N	-	144.5	144.5	144.5	144.5			
					$M_{0,max}$	222.8	310.5	377.0	372.9	374.6			
					M_{max}	223.0	310.5	377.0	372.9	374.6			
					η_{eto}	-	-	-	-	-			
22P14-...2F□□	135.0	1425	45.6	20.10	M_0		-	-	156.0	156.0	156.0	156.0	
					M_N			-	134.7	134.7	134.7	134.7	
					$M_{0,max}$			185.1	230.6	267.1	343.7	418.3	500.0
					M_{max}			185.1	230.6	267.1	344.4	420.0	500.0
					η_{eto}			-	-	-	-	-	-
22P17-...2F□□	130.0	1670	50.3	22.70	M_0			-	-	156.0	156.0	156.0	
					M_N			-	-	129.8	129.8	129.8	
					$M_{0,max}$			198.6	230.2	300.0	365.3	447.0	
					M_{max}			198.6	230.4	300.0	367.5	449.9	
					η_{eto}			-	-	-	-	-	
22P29-...2F□□	125.0	2935	86.0	38.40	M_0					-	-	156.0	
					M_N					-	-	124.9	
					$M_{0,max}$					176.1	218.9	263.2	
					M_{max}					176.4	219.6	264.1	
					η_{eto}					-	-	-	
26T05-...2F□□	296.0	550	44.5	17.00	M_0		-	-	325.0	325.0	325.0	325.0	
					M_N		-	-	295.2	295.2	295.2	295.2	
					$M_{0,max}$		390.4	489.6	567.1	744.4	902.3	1080.2	
					M_{max}		390.4	490.2	568.0	744.8	904.7	1080.2	
					η_{eto}		-	-	-	-	-	-	
26T10-...2F□□	288.0	1030	76.2	31.10	M_0							325.0	
					M_N							288.3	
					$M_{0,max}$					429.7	532.5	638.2	
					M_{max}					431.4	534.1	641.5	
					η_{eto}					-	-	-	

- $I...$ [A], $M...$ [Nm], $n...$ [r/min], $P...$ [kW]
- If the motors are operated at a lower switching frequency, please contact your Lenze sales office!

MQA asynchronous servo motors

Technical data



Selection tables, Inverter Drives 8400 TopLine

Forced ventilated IP23s motors

- The data applies to a mains connection voltage of 3 x 400 V and an inverter switching frequency of 8 kHz.

					E84AVTC	□1134	□1534	□1834	□2234	□3034	□3734	□4534	
					I_N	23.5	32.0	39.0	47.0	61.0	76.0	89.0	
					$I_{0,max}$	32.9	43.2	60.0	70.5	91.5	114.0	133.5	
MQA	M_N	n_N	I_N	P_N	I_{max}	47.0	64.0	78.0	94.0	122.0	152.0	178.0	
26T12- ...2F□□	282.0	1200	88.8	35.40	M_0						-	325.0	
					M_N							-	281.7
					$M_{0,max}$							458.2	550.4
					M_{max}							460.6	552.9
					η_{eto}								

- $I...$ [A], $M...$ [Nm], $n...$ [r/min], $P...$ [kW]
- If the motors are operated at a lower switching frequency, please contact your Lenze sales office!

MQA asynchronous servo motors

Technical data

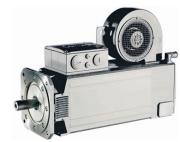

Selection tables, Servo Inverter 9300

Forced ventilated IP23s motors

- The data applies to a mains connection voltage of 3 x 400 V and an inverter switching frequency of 8 kHz.

					EVS	9326-E□	9327-E□	9328-E□	9329-E□	9330-E□	9331-E□	9332-E□
					I_N	23.5	32.0	47.0	59.0	89.0	110.0	145.0
					$I_{0,max}$	23.5	32.0	47.0	52.0	80.0	110.0	126.0
MQA	M_N	n_N	I_N	P_N	I_{max}	35.3	48.0	70.5	88.5	133.5	165.0	217.5
20L14-...2F□□	71.3	1420	26.5	10.60	M_0	61.0	76.0	76.0				
					M_N	61.0	71.3	71.3				
					$M_{0,max}$	61.0	112.0	187.0				
					M_{max}	109.3	156.7	232.1				
					η_{eto}	-	-	-				
20L29-...2F□□	66.2	2930	46.9	20.30	M_0		28.0	66.3	76.0	76.0		
					M_N		28.0	66.2	66.2	66.2		
					$M_{0,max}$		28.0	66.3	95.0	169.0		
					M_{max}		68.5	112.5	146.4	226.7		
					η_{eto}		-	-	-	-		
22P08-...2F□□	145.0	760	27.6	11.50	M_0		156.0	156.0	156.0			
					M_N		145.0	145.0	145.0			
					$M_{0,max}$		177.0	280.0	293.0			
					M_{max}		247.0	338.8	345.8			
					η_{eto}		-	-	-			
22P14-...2F□□	135.0	1425	45.6	20.10	M_0			146.0	156.0	156.0		
					M_N			135.0	135.0	135.0		
					$M_{0,max}$			146.0	186.0	188.0		
					M_{max}			230.1	292.9	341.8		
					η_{eto}			-	-	-		
22P17-...2F□□	130.0	1670	50.3	22.70	M_0			124.0	156.0	156.0	156.0	
					M_N			124.0	130.0	130.0	130.0	
					$M_{0,max}$			124.0	140.0	240.0	335.0	
					M_{max}			180.5	227.7	342.1	378.3	
					η_{eto}			-	-	-	-	
22P29-...2F□□	125.0	2935	86.0	38.40	M_0					135.5	156.0	156.0
					M_N					125.0	125.0	125.0
					$M_{0,max}$					137.0	195.0	250.0
					M_{max}					215.6	273.1	355.1
					η_{eto}					-	-	-
26T05-...2F□□	296.0	550	44.5	17.00	M_0			303.0	325.0	325.0		
					M_N			296.0	296.0	296.0		
					$M_{0,max}$			303.0	333.0	615.0		
					M_{max}			482.0	612.0	751.0		
					η_{eto}			-	-	-		
26T10-...2F□□	288.0	1030	76.2	31.10	M_0					319.0	325.0	
					M_N					288.0	288.0	
					$M_{0,max}$					300.0	440.0	
					M_{max}					552.0	671.0	
					η_{eto}					-	-	

5.4

- $I...$ [A], $M...$ [Nm], $n...$ [r/min], $P...$ [kW]
- If the motors are operated at a lower switching frequency, please contact your Lenze sales office!

MQA asynchronous servo motors

Technical data



Selection tables, Servo Inverter 9300

Forced ventilated IP23s motors

- The data applies to a mains connection voltage of 3 x 400 V and an inverter switching frequency of 8 kHz.

					EVS	9326-E□	9327-E□	9328-E□	9329-E□	9330-E□	9331-E□	9332-E□
					I _N	23.5	32.0	47.0	59.0	89.0	110.0	145.0
					I _{0,max}	23.5	32.0	47.0	52.0	80.0	110.0	126.0
MQA	M _N	n _N	I _N	P _N	I _{max}	35.3	48.0	70.5	88.5	133.5	165.0	217.5
26T12- ...2F□□	282.0	1200	88.8	35.40	M ₀					284.0	325.0	325.0
					M _N					282.0	282.0	282.0
					M _{0,max}					258.0	327.0	397.0
					M _{max}					424.0	512.0	663.0
					η _{eto}					-	-	-
26T22- ...2F□□	257.0	2235	138.1	60.10	M ₀						177.0	222.0
					M _N						177.0	257.0
					M _{0,max}						203.0	220.0
					M _{max}						315.0	432.0
					η _{eto}						-	-

- I... [A], M... [Nm], n... [r/min], P... [kW]
- If the motors are operated at a lower switching frequency, please contact your Lenze sales office!

MQA asynchronous servo motors

Technical data

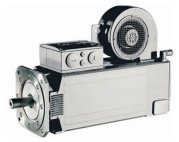

Torque characteristics

► The data applies to a mains connection voltage of 3 x 400 V.

MQA20L14...2F□□ (forced ventilated)

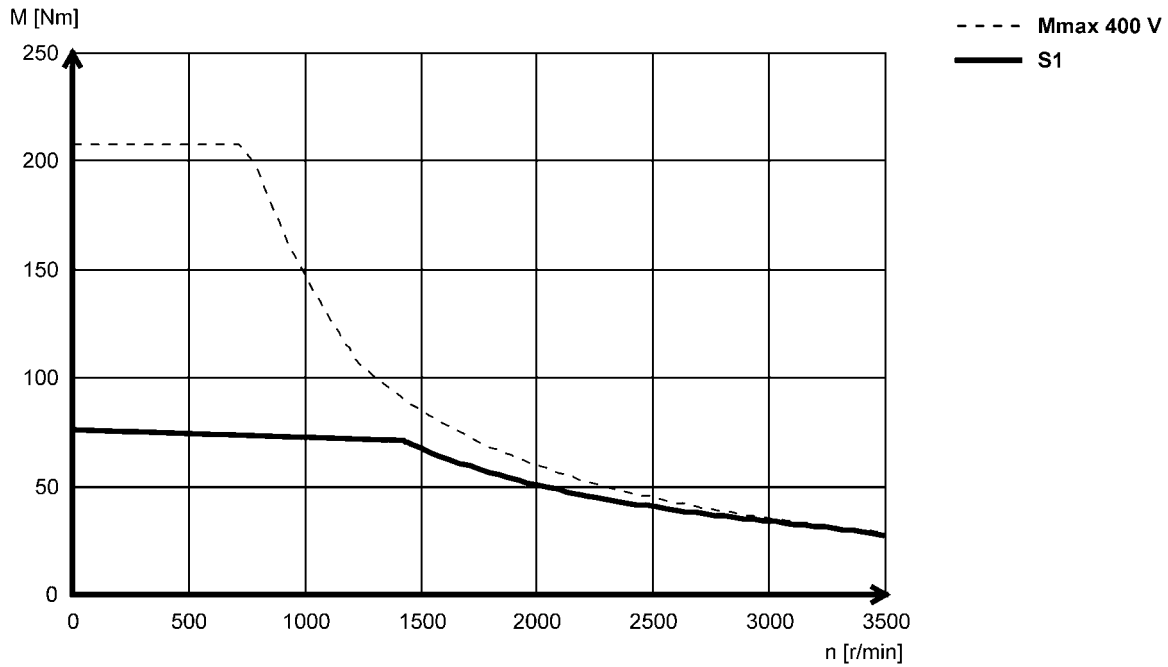

MQA20L29...2F□□ (forced ventilated)

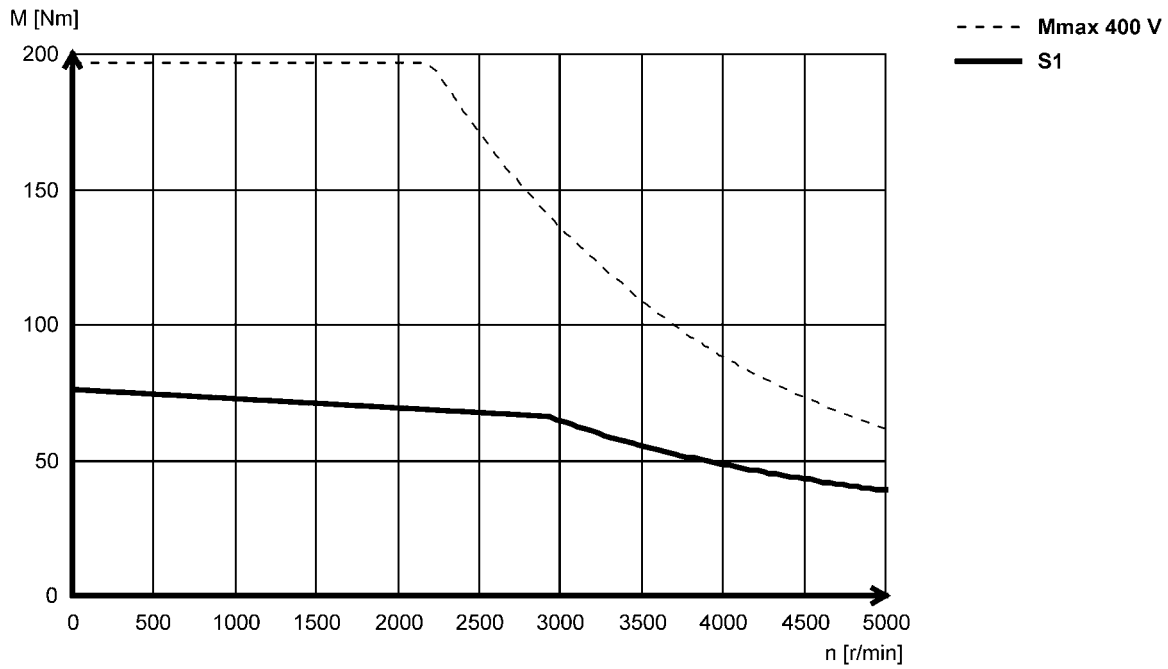

5.4

MQA asynchronous servo motors

Technical data



Torque characteristics

► The data applies to a mains connection voltage of 3 x 400 V.

MQA22P08...2F□□ (forced ventilated)

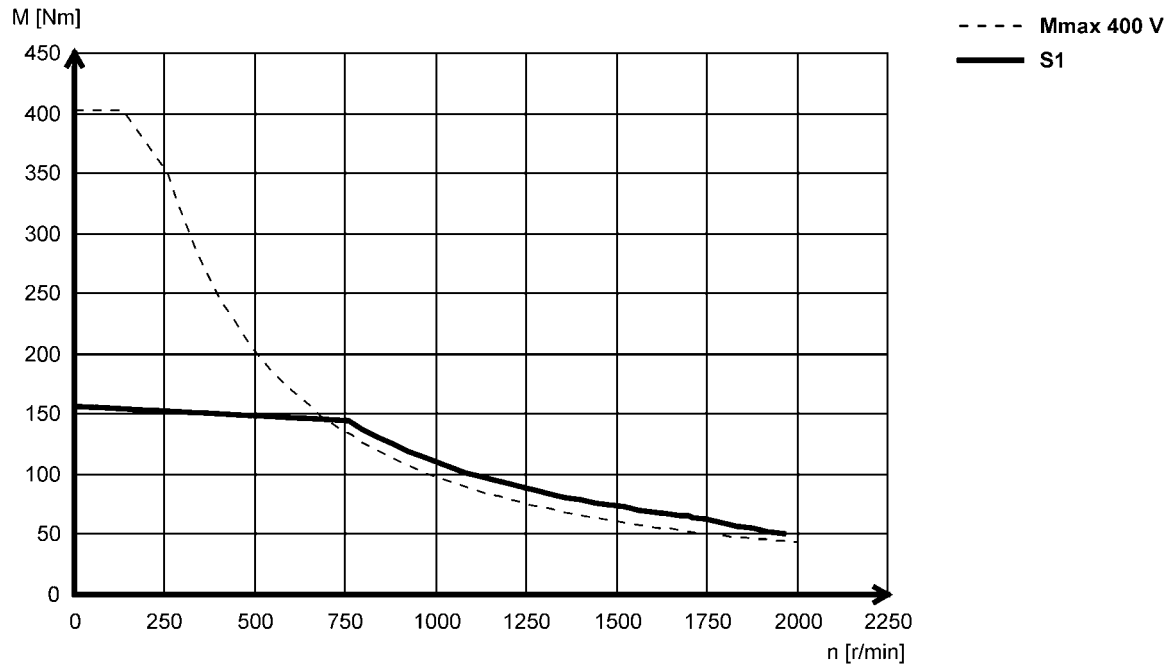

MQA22P14...2F□□ (forced ventilated)

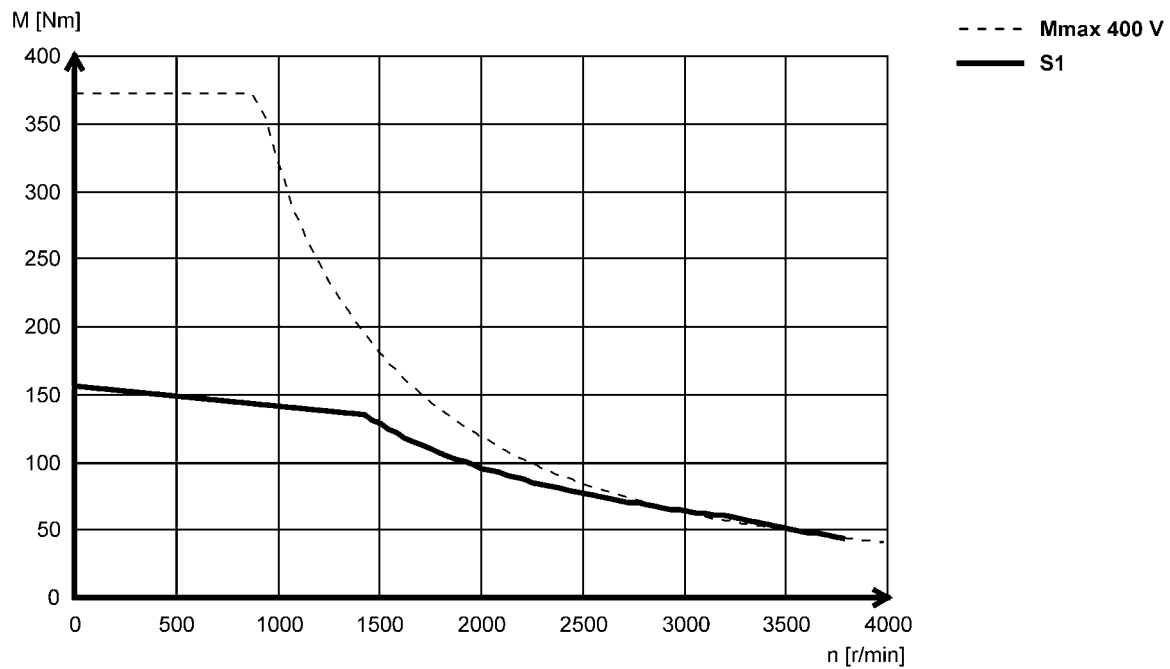

5.4

MQA asynchronous servo motors

Technical data



Torque characteristics

► The data applies to a mains connection voltage of 3 x 400 V.

MQA22P17...2F□□ (forced ventilated)

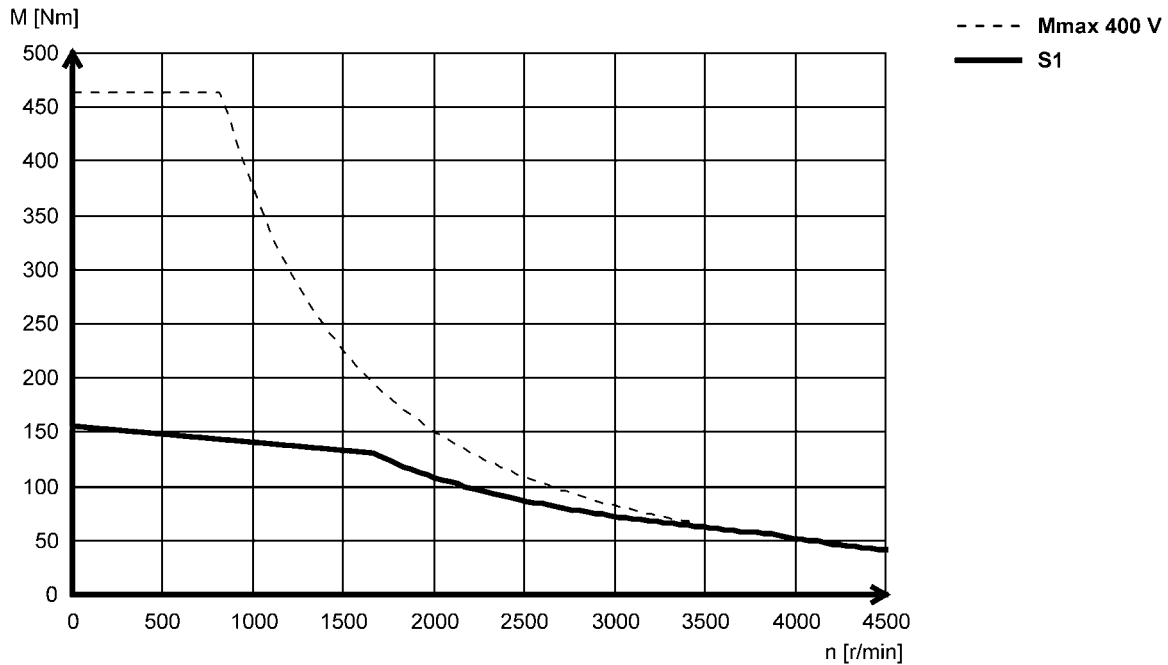

MQA22P29...2F□□ (forced ventilated)

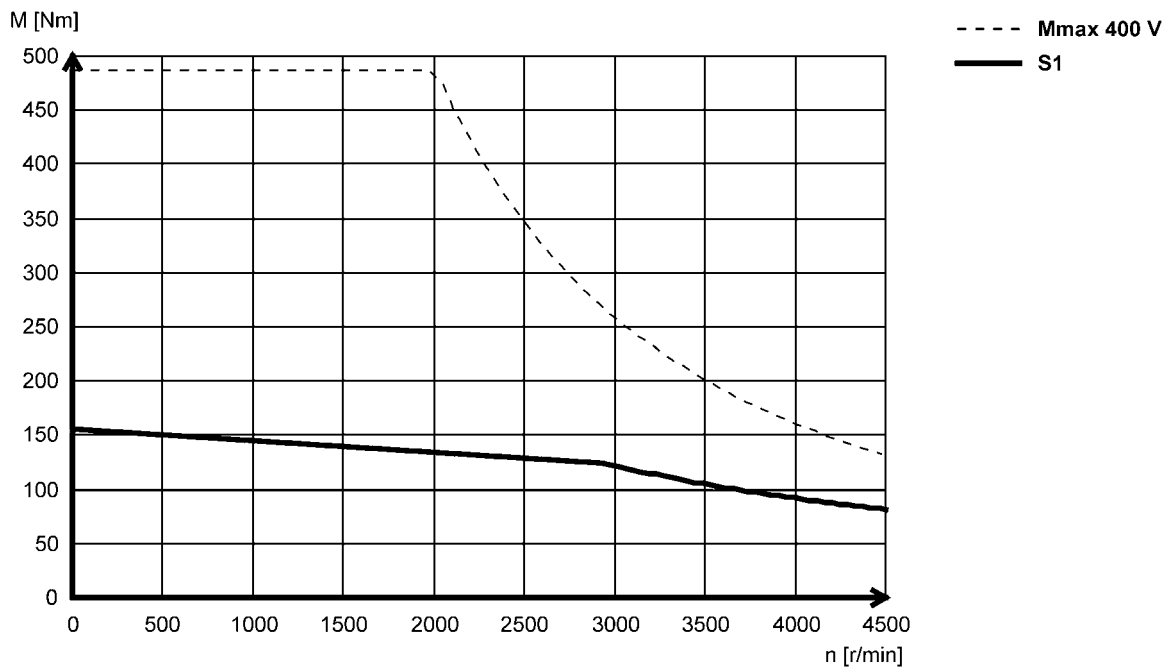

MQA asynchronous servo motors

Technical data



Torque characteristics

► The data applies to a mains connection voltage of 3 x 400 V.

MQA26T05...2F□□ (forced ventilated)

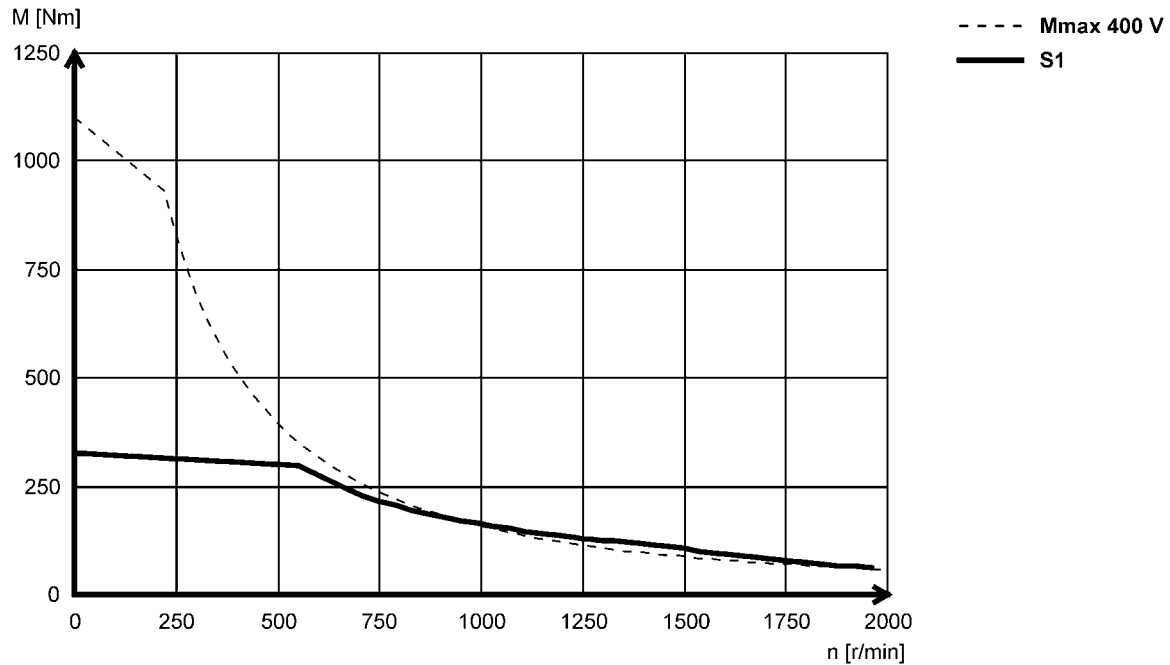

MQA26T10...2F□□ (forced ventilated)

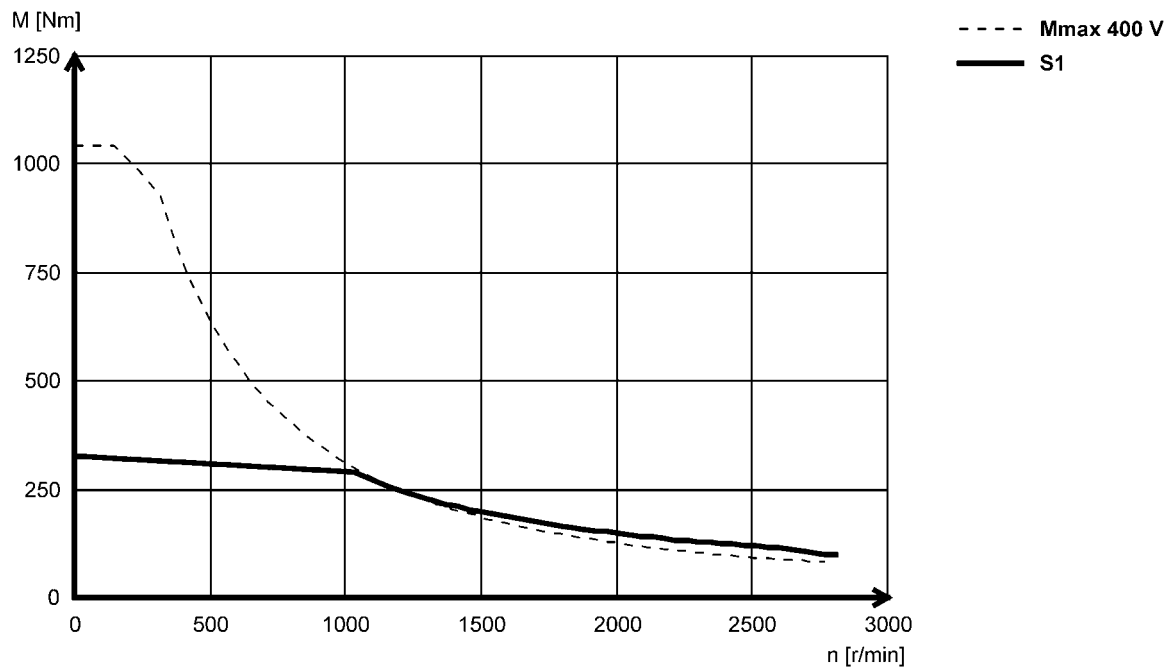

5.4

MQA asynchronous servo motors

Technical data



Torque characteristics

► The data applies to a mains connection voltage of 3 x 400 V.

MQA26T12...2F□□ (forced ventilated)

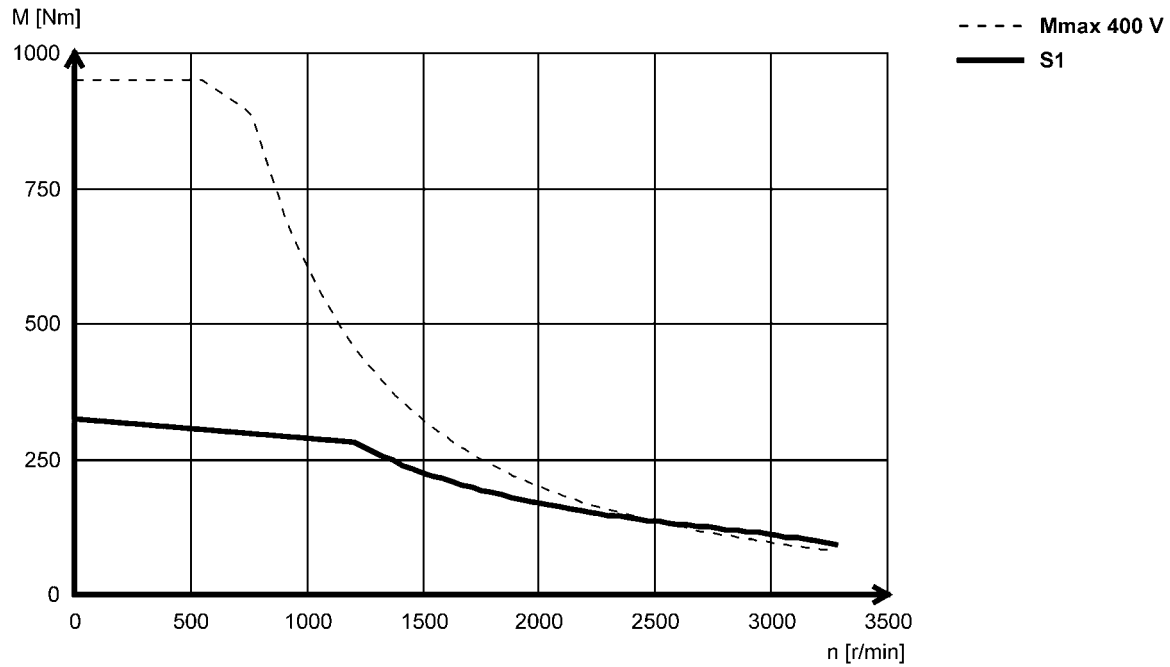

MQA26T22...2F□□ (forced ventilated)

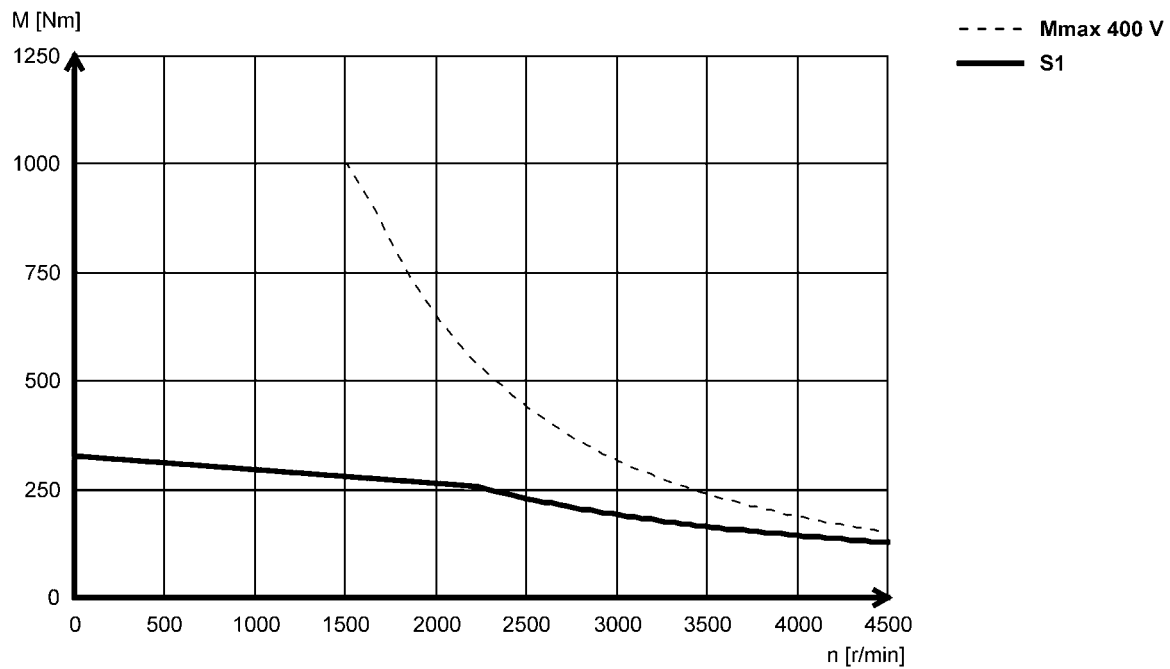

5.4

MQA asynchronous servo motors

Technical data



Dimensions, forced ventilated

Design B3

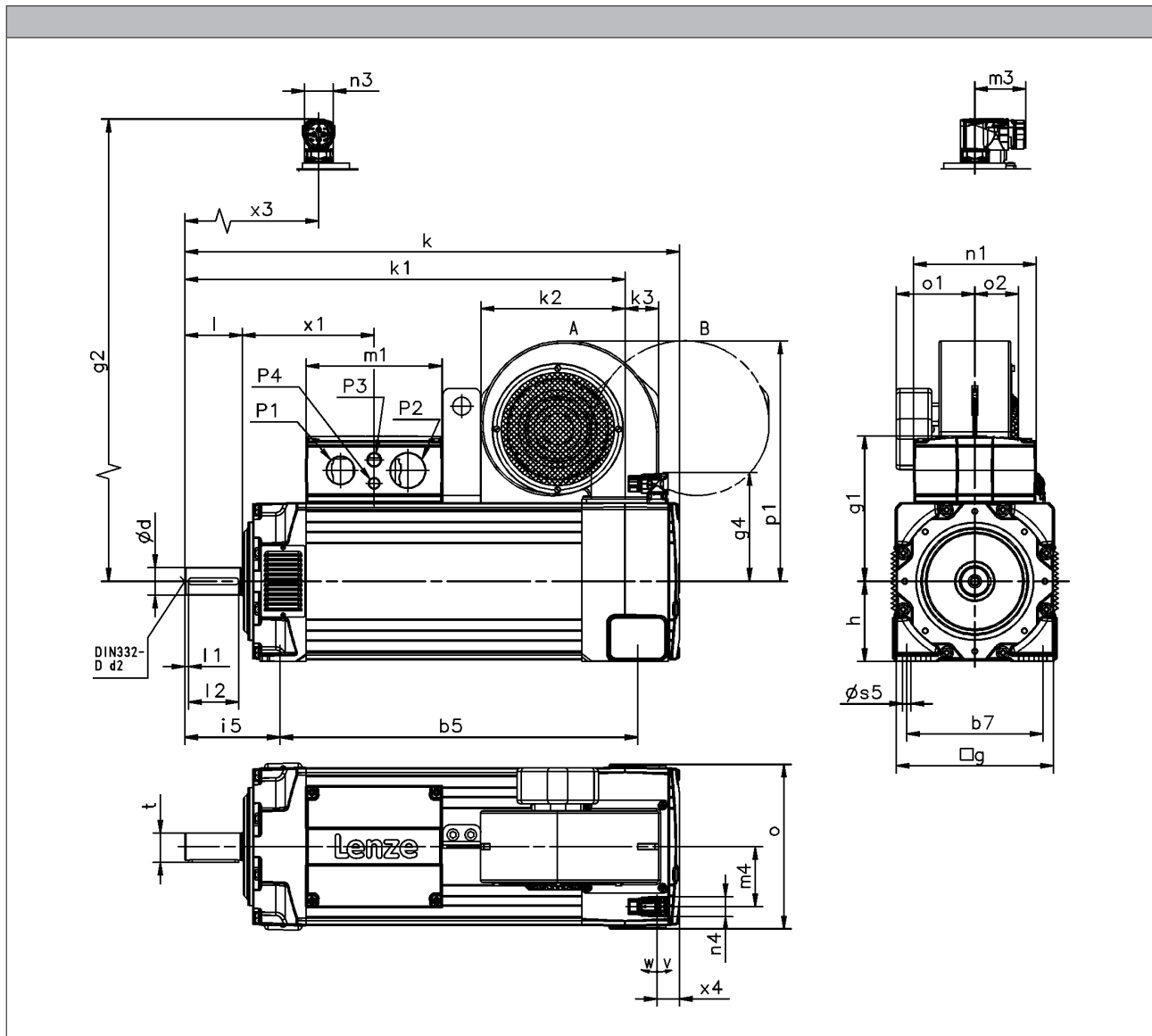

5.4

			MQA20	MQA22	MQA26
R□□ / E□□ / T□□ / S□□ / B0	k	[mm]	577	691	841
	x ₄	[mm]	33.0	31.0	24.0
	m ₄	[mm]	74.0	84.0	100
R□□ F1	k	[mm]	661	773	979
	x ₄	[mm]	41.0	40.0	
	m ₄	[mm]	70.0	76.0	96.0
E□□ / T□□ / S□□ / F1	k	[mm]	704	816	1017
	x ₄	[mm]	46.0	45.0	40.0
	m ₄	[mm]	70.0	76.0	96.0
R□□ / E□□ / T□□ / S□□ / F2	k	[mm]	729	848	1017
	x ₄	[mm]	46.0	45.0	40.0
	m ₄	[mm]	70.0	76.0	96.0

- ▶ Speed/angle sensor: R50 / S□□ / E□□ / T□□
- ▶ Brake: B0 / F1 / F2

MQA asynchronous servo motors

Technical data

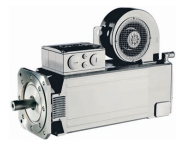

Dimensions, forced ventilated

Design B3

	g	g ₁	g ₂	g ₄	m ₁	m ₃	n ₁	n ₃	n ₄
	[mm]	[mm]	[mm]	[mm]	[mm]	[mm]	[mm]	[mm]	[mm]
MQA20	200	171	168	141	154	72	128	40	28
MQA22	220	203		153	190		171		
MQA26	260	256		173	234		212		

	o	P ₁	P ₂	P ₃	P ₄	v	w	x ₁	x ₃
	[mm]	[mm]	[mm]	[mm]	[mm]	[°]	[°]	[mm]	[mm]
MQA20	206	M32x1.5	M25x1.5	M20x1.5	M16x1.5	195	80	155	192
MQA22	230	M50x1.5	M40x1.5					184	
MQA26	266	M63x1.5	M50x1.5					218	

	d	d	d ₂	l	l ₁	l ₂	u	t
	k6	m6		-0.7 ... 0.3				
	[mm]	[mm]	[mm]		[mm]	[mm]	[mm]	[mm]
MQA20	38		M12	80	5.0	70	10.0	41.0
MQA22								
MQA26		55	M20	110		100	16.0	59.0

	h	b ₅	b ₇	s ₅	i ₅
	[mm]	[mm]	[mm]	[mm]	[mm]
MQA20	100	386	160	11.5	134
MQA22	112	500	190		133
MQA26	132	605	215	14.0	165

	F10 / F30						F1F / F3F					
	k ₁	k ₂	k ₃	o ₁	o ₂	p ₁	k ₁	k ₂	k ₃	o ₁	o ₂	p ₁
	[mm]	[mm]	[mm]	[mm]	[mm]	[mm]	[mm]	[mm]	[mm]	[mm]	[mm]	[mm]
MQA20	498	152	32.0	118	47.0	276	498	152	32.0	118	124	276
MQA22	615	201	47.0	110	63.0	336	615	201	47.0	104	144	336
MQA26	764	221	60.0	125	86.0	391	764	221	60.0	120	140	391

5.4

MQA asynchronous servo motors

Technical data



Dimensions, forced ventilated

Design B35

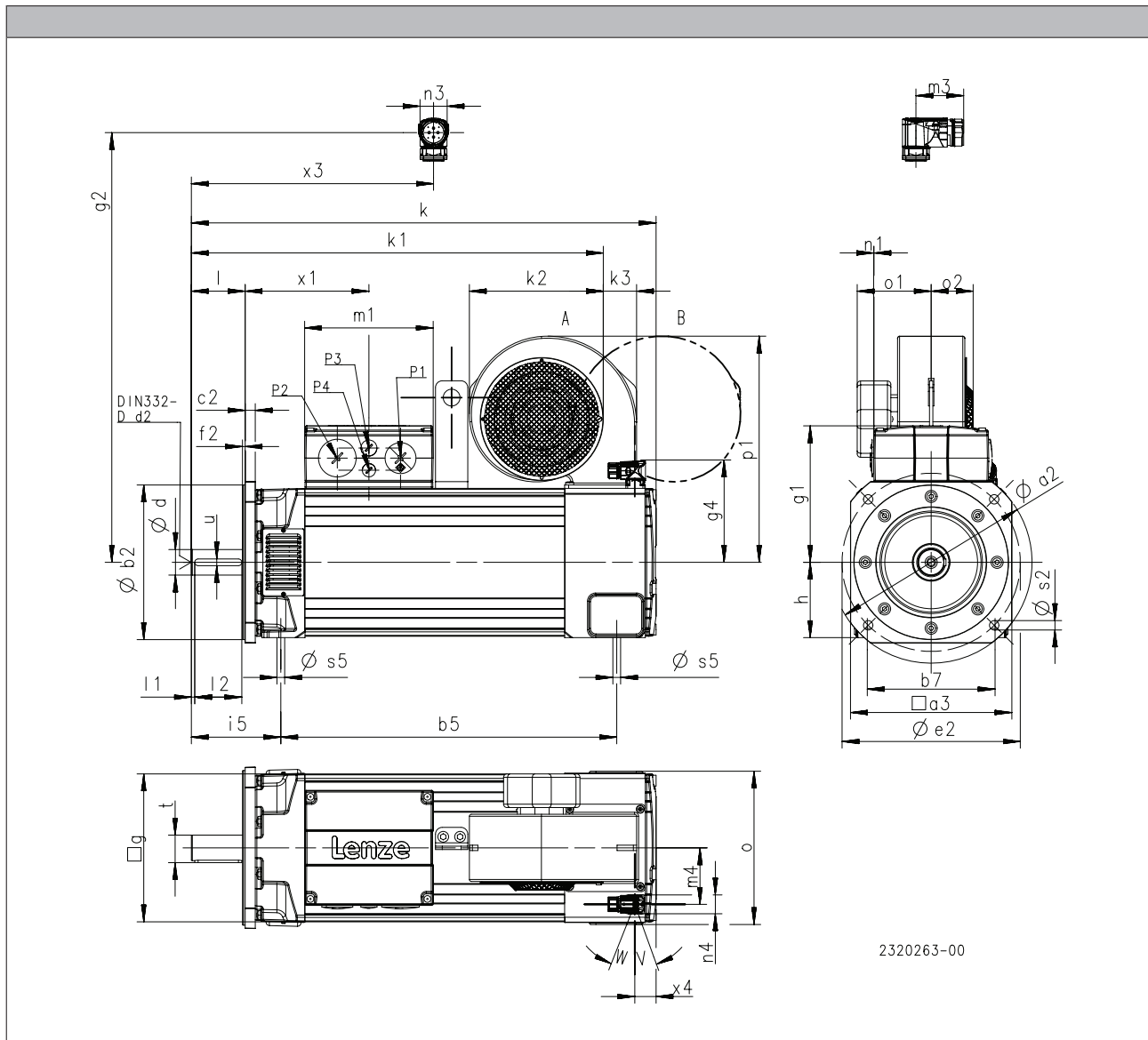

5.4

			MQA20	MQA22	MQA26
R□□ / E□□ / T□□ / S□□ / B0	k	[mm]	577	691	841
	x ₄	[mm]	33.0	31.0	24.0
	m ₄	[mm]	74.0	84.0	100
R□□ F1	k	[mm]	661	773	979
	x ₄	[mm]	41.0	40.0	40.0
	m ₄	[mm]	70.0	76.0	96.0
E□□ / T□□ / S□□ / F1	k	[mm]	704	816	1017
	x ₄	[mm]	46.0	45.0	40.0
	m ₄	[mm]	70.0	76.0	96.0
R□□ / E□□ / T□□ / S□□ / F2	k	[mm]	729	848	1017
	x ₄	[mm]	46.0	45.0	40.0
	m ₄	[mm]	70.0	76.0	96.0

- ▶ Speed/angle sensor: RS0 / S□□ / E□□ / T□□
- ▶ Brake: B0 / F1 / F2

MQA asynchronous servo motors

Technical data



Dimensions, forced ventilated

Design B35

	g	g ₁	g ₂	g ₄	m ₁	m ₃	n ₁	n ₃	n ₄
	[mm]	[mm]	[mm]	[mm]	[mm]	[mm]	[mm]	[mm]	[mm]
MQA20	200	171	168	141	154	72	128	40	28
MQA22	220	203		153	190		171		
MQA26	260	256		173	234		212		

	o	P ₁	P ₂	P ₃	P ₄	v	w	x ₁	x ₃
	[mm]	[mm]	[mm]	[mm]	[mm]	[°]	[°]	[mm]	[mm]
MQA20	206	M32x1.5	M25x1.5	M20x1.5	M16x1.5	195	80	155	192
MQA22	230	M50x1.5	M40x1.5					184	
MQA26	266	M63x1.5	M50x1.5					218	

	d	d	d ₂	l	l ₁	l ₂	u	t
	k6	m6		-0.7 ... 0.3				
	[mm]	[mm]	[mm]		[mm]	[mm]	[mm]	[mm]
MQA20	38		M12	80	5.0	70	10.0	41.0
MQA22								
MQA26		55	M20	110		100	16.0	59.0

	h	b ₅	b ₇	s ₅	i ₅
	[mm]	[mm]	[mm]	[mm]	[mm]
MQA20	100	386	160	11.5	134
MQA22	112	500	190		133
MQA26	132	605	215	14.0	165

	a ₂	a ₃	b ₂	b ₂	c ₂	e ₂	f ₂	s ₂
			j6	h6				
	[mm]	[mm]	[mm]	[mm]	[mm]	[mm]	[mm]	[mm]
MQA20	250	196	180		15	215	4.0	14
MQA22	300	240	230			265		
MQA26	400	320		300		350	5.0	18

	F10 / F30						F1F / F3F					
	k ₁	k ₂	k ₃	o ₁	o ₂	p ₁	k ₁	k ₂	k ₃	o ₁	o ₂	p ₁
	[mm]	[mm]	[mm]	[mm]	[mm]	[mm]	[mm]	[mm]	[mm]	[mm]	[mm]	[mm]
MQA20	498	152	32.0	118	47.0	276	498	152	32.0	118	124	276
MQA22	615	201	47.0	110	63.0	336	615	201	47.0	104	144	336
MQA26	764	221	60.0	125	86.0	391	764	221	60.0	120	140	391

MQA asynchronous servo motors

Technical data



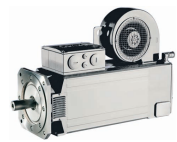

Spring-applied holding brake

The servo motors can be equipped with spring-operated holding brakes.

The brakes are activated when the supply voltage is disconnected (closed-circuit principle). When using the brakes purely as holding brakes, virtually no wear occurs on the friction surfaces.

Caution:

The brakes used are not safety brakes in the sense that a reduction in torque may arise as a result of disruptive factors that cannot be influenced, e.g. oil ingress.

The ohmic voltage drop along the cable must be taken into consideration in long motor supply cables and must be compensated for by a higher voltage at the line input.

The following applies for Lenze system cables:

$$U[V] = U_B[V] + 0.08 \frac{[V]}{[A] \cdot [m]} \cdot l_{lg}[m] \cdot I_B[A]$$

If no suitable voltage (incorrect value, incorrect polarity) is applied to the brake, the brake will be applied and can be overheated and destroyed by the motor continuing to rotate.

The shortest switching times of the brakes are achieved by DC switching of the voltage. A spark suppressor is required to suppress interference and to increase the service life of the relay contacts here.



Spring-applied holding brake



Spring-applied holding brake

Rated data with standard braking torque

- The figures stated apply to servo motors. They only apply to geared servo motors when the servo motor is connected via a mounting flange.

	U _{N,DC} ^{3,6)}	U _{N,AC} ^{4,6)}	M _N	M _N	M _{av}	I _N ²⁾	J	t ₁ ¹⁾	t ₂ ¹⁾	Q _E ⁵⁾	m	J _{MB}	J _L /J _{MB}
			20 °C	120 °C	120 °C								
	[V]	[V]	[Nm]	[Nm]	[Nm]	[A]	[kgcm ²]	[ms]	[ms]	[J]	[kg]	[kgcm ²]	
MQA20	24	230	90.0	80.0	50.0	3.13	6.88	70.0	220	18000	13.0	177	19.6
	0.37												
MQA22	24	230	150	130	80.0	3.75	18.1	50.0	260	23000	20.5	505	8.20
	0.44					130							
MQA26	24	230	300	260	200	3.13	70.4	175	320	51000	30.7	1405	12.7
	0.37					360							

Rated data with increased braking torque

- The figures stated apply to servo motors. They only apply to geared servo motors when the servo motor is connected via a mounting flange.

	U _{N,DC} ^{3,6)}	U _{N,AC} ^{4,6)}	M _N	M _N	M _{av}	I _N ²⁾	J	t ₁ ¹⁾	t ₂ ¹⁾	Q _E ⁵⁾	m	J _{MB}	J _L /J _{MB}
			20 °C	120 °C	120 °C								
	[V]	[V]	[Nm]	[Nm]	[Nm]	[A]	[kgcm ²]	[ms]	[ms]	[J]	[kg]	[kgcm ²]	
MQA20	24	230	150	130	100	2.58	14.1	70.0	240	31000	15.4	185	33.0
	0.30												
MQA22	24	230	300	260	160	3.75	36.3	175	320	39000	26.0	523	14.1
	0.44					130		310					

- 1) Engagement and disengagement times are valid for rated voltage ($\pm 0\%$) and protective circuit for brakes with varistor for DC switching. The times may increase without a protective circuit.
- 2) The currents are the maximum values when the brake is cold (value used for dimensioning the current supply). The values for a motor at operating temperature are considerably lower.
- 3) With 24V DC brake: smoothed DC voltage, ripple $\leq 1\%$.
- 4) UR not possible in the case of a brake with 230 V supply voltage.
- 5) Maximum switching energy per emergency stop at $n = 3000$ rpm for at least 300 emergency stops, maximally 4 emergency stops per hour.
- 6) Voltage tolerance: permanent magnet brakes -10% to +5%
spring-applied brakes $\pm 10\%$

MQA asynchronous servo motors

Accessories



Resolver

Stator-fed resolver with two stator windings offset by 90° and one rotor winding with transformer winding.

- The version MQA20, MQA22 and MQA26 with brake and resolver RV03 is not permissible!

Speed/angle sensor				RS0	RV0
	1)			RS0	RV0
Product key				RS0	RV03
Resolution					
Angle			[°]	0.80	
Accuracy					
			[°]	-10 ... 10	
Absolute positioning					
				1 revolution	
Max. speed					
	n_{max}		[r/min]	8000	
Max. input voltage					
DC	$U_{in,max}$		[V]	10.0	
Max. input frequency					
	$f_{in,max}$		[kHz]	4.00	
Ratio					
Stator / rotor		$\pm 5\%$		0.30	
Rotor impedance					
	Z_{r0}		[Ω]	51 + j90	
Stator impedance					
	Z_{s0}		[Ω]	102 + j150	
Impedance					
	Z_{rs}		[Ω]	44 + j76	
Min. insulation resistance					
At DC 500 V	R		[MΩ]	10.0	
Number of pole pairs					
				1	
Max. angle error					
			[°]	-10 ... 10	
Inverter assignment					
				i700 E84AVTC E94A ECS EVS93	E84AVTC E94A ECS EVS93

1) 6 - Product key > speed/angle sensor

Speed-dependent safety functions

Suitable for safety function				No	Yes
Max. permissible angular acceleration					
MQA20 ... MQA26 ²⁾	α		[rad/s ²]	22000	
Functional safety					
IEC 61508				SIL3	
EN 13849-1				Up to Performance Level e	

2) 1 - Single encoder concepts with resolvers



Incremental encoder and SinCos absolute value encoder

Encoder type			TTL incremental		SinCos incremental	
Speed/angle sensor			T20	T40	S20	S15
Product key			IG2048-5V-T	IG4096-5V-T	IG2048-5V-S	IG1024-5V-V3
Encoder type			Single-turn			
Pulses			2048	4096	2048	1024
Output signals			TTL		1 V _{SS}	
Interfaces			A, B, N track and inverted			
Absolute revolutions			0			
Resolution						
Angle ²⁾		[°]	2.60	1.30	0.40	
Accuracy		[°]	-2 ... 2		-0.8 ... 0.8	
Min. input voltage						
DC	U _{in,min}	[V]	4.75		4.50	4.75
Max. input voltage						
DC	U _{in,max}	[V]	5.25		5.50	5.25
Max. speed						
	n _{max}	[r/min]	8789		5273	8000
Max. current consumption						
	I _{max}	[A]	0.15		0.10	0.070
Limit frequency						
	f _{max}	[kHz]	300		180	200
Inverter assignment			E84AVTC E94A ECS EVS93		E94A	

¹⁾ 6 - Product key > speed/angle sensor

²⁾ Inverter-dependent.

Speed-dependent safety functions

Suitable for safety function			No	No	No	Yes
Max. permissible angular acceleration						
MQA20 ... MQA26	α	[rad/s ²]	73 000			
Functional safety						
IEC 61508			SIL3			
EN 13849-1			Up to Performance Level e			

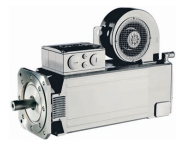

Incremental encoder and SinCos absolute value encoder

Encoder type			SinCos absolute value			
Speed/angle sensor			SRS	SRM	ECN	EQN
Product key			AS1024-8V-H	AM1024-8V-H	AS2048-5V-E	AM2048-5V-E
Encoder type			Single-turn	Multi-turn	Single-turn	Multi-turn
Pulses			1024		2048	
Output signals			1 Vss			
Interfaces			Hiperface		EnDat	
Absolute revolutions			1	4096	1	4096
Resolution			0.40			
Angle			[°]			
Accuracy			-0.8 ... 0.8		-0.6 ... 0.6	
Min. input voltage						
DC	$U_{in,min}$	[V]	7.00		4.75	
Max. input voltage						
DC	$U_{in,max}$	[V]	12.0		5.25	
Max. speed						
	n_{max}	[r/min]	6000		12000	
Max. current consumption						
	I_{max}	[A]	0.080		0.15	0.25
Limit frequency						
	f_{max}	[kHz]	200			
Inverter assignment			E84AVTC E94A ECS EVS93		E94A	

1) 6 - Product key > speed/angle sensor

MQA asynchronous servo motors

Accessories



Blower

Rated data for 50 Hz

		Degree of protection	Number of phases	U_{min}	U_{max}	$U_{N,AC}$	P_N	I_N
				[V]	[V]	[V]	[kW]	[A]
MQA20	F10 F1F	IP23s	1	210	250	230	0.090	0.39
	F30 F3F		3	360	440	400	0.067	0.13
MQA22	F10 F1F		1	210	250	230	0.26	1.10
	F30 F3F		3	360	440	400	0.23	0.37
MQA26	F30 F3F						0.43	0.68

Rated data for 60 Hz

		Degree of protection	Number of phases	U_{min}	U_{max}	$U_{N,AC}$	P_N	I_N
				[V]	[V]	[V]	[kW]	[A]
MQA20	F10 F1F	IP23s	1	210	250	230	0.12	0.49
	F30 F3F		3	440	520	480	0.10	0.16
MQA22	F10 F1F		1	210	250	230	0.30	1.28
	F30 F3F		3	440	520	480	0.37	0.48
MQA26	F30 F3F						0.60	0.79



Temperature monitoring

The thermal sensors (1x KTY 83-110) used continuously monitor the motor temperature. The temperature signal is transmitted over the system cable of the feedback system to the servo controller. This means that the temperature of the motor is determined with great accuracy in the permitted operating range and at the same time the overtemperature response configured in the controller is executed in the event of overtemperature in one of the winding phases.

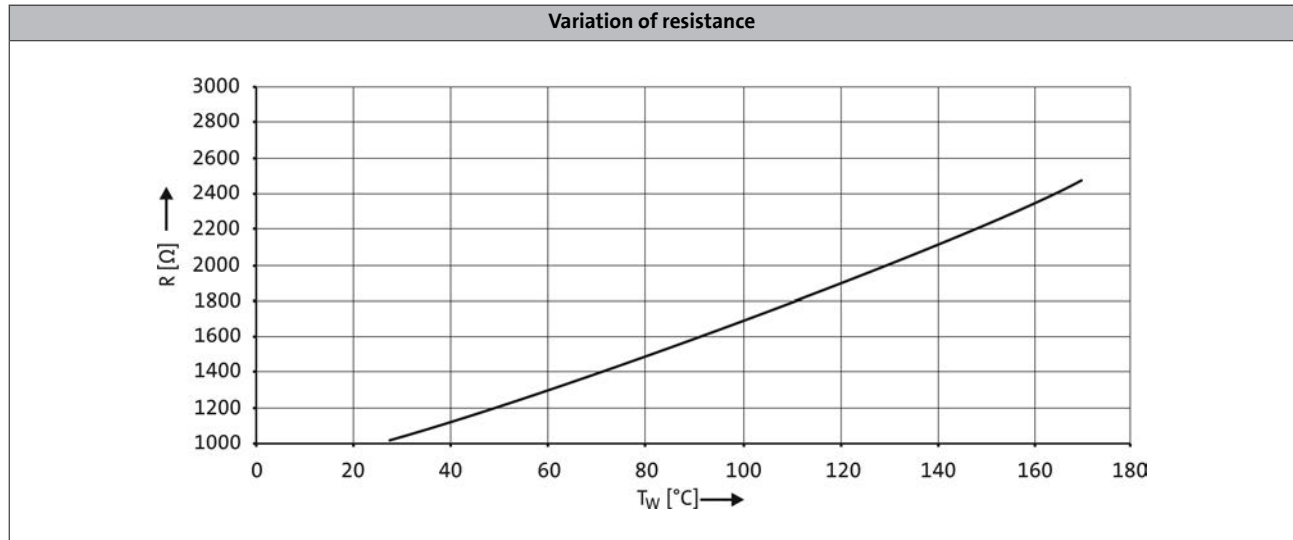

- If the thermal sensor is supplied with a measurement current of 1 mA, the above relationship between the temperature and the resistance applies.

MQA asynchronous servo motors

Accessories



ICN connector

A connector is used for motor and brake connection.
The connection to the feedback system employs a separate connector.

The connectors can be rotated through 270° and are fitted with a bayonet catch for SpeedTec connectors. As the connector fixing is also compatible with conventional union nuts. Existing mating connectors can therefore still be used without difficulty.

Connection for power and brake

► MQA20

Pin assignment		
Contact	Designation	Meaning
1		Not assigned
2		
+	BD1	Holding brake +
-	BD2	Holding brake -
PE	PE	PE conductor
U	U	Phase U power
V	V	Phase V power
W	W	Phase W power

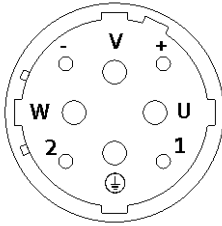
A circular diagram of the motor's terminal block. It shows seven pins arranged in a circle. The top pin is labeled 'V' with a '-' sign on the left and a '+' sign on the right. Moving clockwise from the top: the next pin is labeled 'U'; the next is labeled '1'; the next is labeled 'W'; the next is labeled '2'; the next is labeled 'PE' with a ground symbol; and the final pin at the top is labeled 'V'.

MQA asynchronous servo motors

Accessories



ICN connector

Feedback connection

► Resolver

Pin assignment		
Contact	Designation	Meaning
1	+Ref	Transformer windings
2	-Ref	
3	+VCC ETS	Supply: Electronic nameplate
4	+COS	Cosine stator windings
5	-COS	
6	+SIN	Sine stator windings
7	-SIN	
8		Not assigned
9		
10		
11	+KTY	KTY temperature sensor
12	-KTY	

► Hiperface incremental encoder and SinCos absolute value encoder

Pin assignment		
Contact	Designation	Meaning
1	B	Track B/+SIN
2	A ⁻	Track A inverse/-COS
3	A	Track A/+COS
4	+U _B	Supply +
5	GND	Mass
6	Z ⁻	Zero track inverse/-RS485
7	Z	Zero track/+RS485
8		Not assigned
9	B ⁻	Track B inverse/-SIN
10		Not assigned
11	+KTY	KTY temperature sensor
12	-KTY	

MQA asynchronous servo motors

Technical data



ICN connector

Feedback connection

- SinCos absolute value encoder with EnDat interface

Pin assignment		
Contact	Designation	Meaning
1	U _p sensor	Supply: UP sensor
2		Not assigned
3		
4	0 V sensor	Supply: 0 V sensor
5	+KTY	KTY temperature sensor
6	-KTY	
7	+U _B	Supply +
8	Cycle	EnDat interface cycle
9	Cycle ⁻	EnDat interface inverse cycle
10	GND	Mass
11	Shield	Encoder housing screen
12	B	Track B
13	B ⁻	Track B inverse/-SIN
14	Data	EnDat interface data
15	A	Track A
16	A ⁻	Track A inverse
17	Data ⁻	EnDat interface inverse data

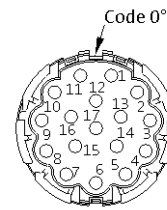

MQA asynchronous servo motors

Technical data



MQA asynchronous servo motors

Technical data



Motors

MCA asynchronous servo motors

2 to 1,100 Nm

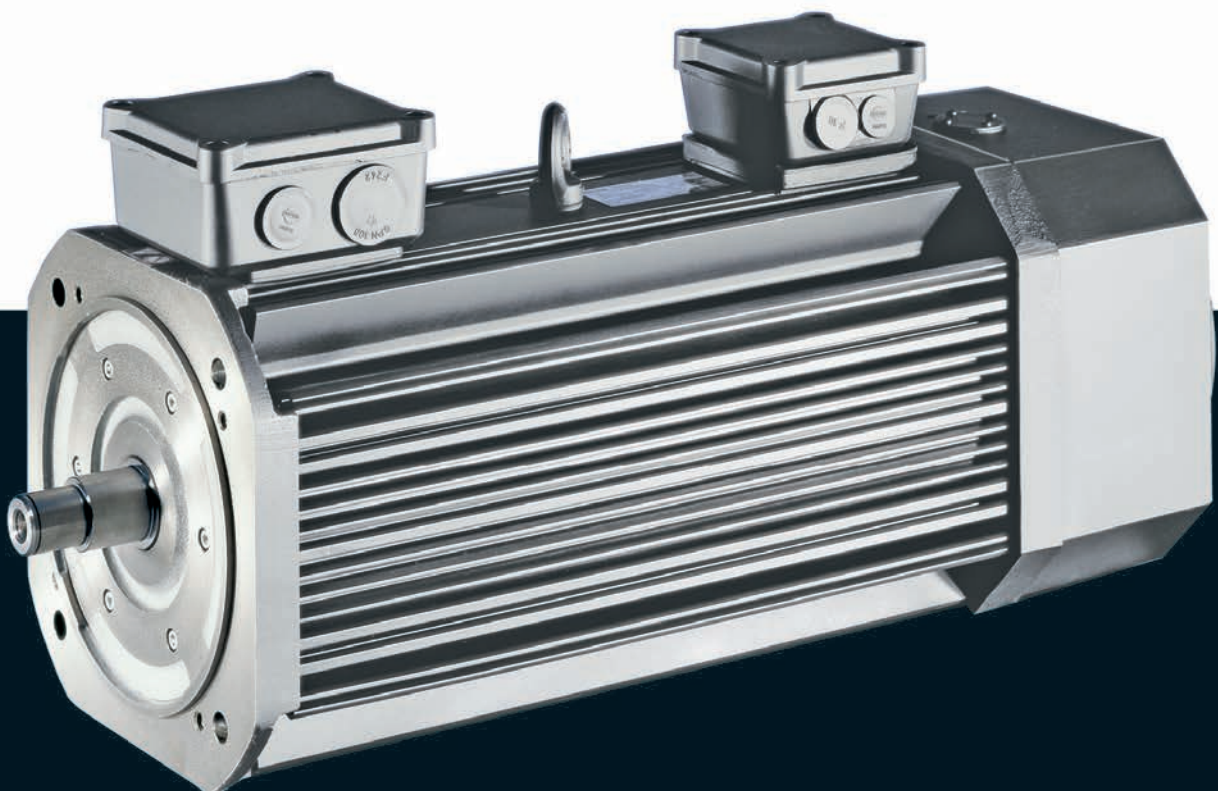

MCA asynchronous servo motors

Contents



General information	List of abbreviations	5.5 - 4	
	Product key	5.5 - 6	
	Product information	5.5 - 8	
	Functions and features	5.5 - 9	
	Dimensioning	5.5 - 11	
Technical data	Standards and operating conditions	5.5 - 19	
	Permissible radial and axial forces	5.5 - 20	
	Rated data, non-ventilated	5.5 - 22	
	Rated data, IP54 forced ventilated	5.5 - 23	
	Rated data, IP23s forced ventilated	5.5 - 24	
	Selection tables, Servo Drives 9400 HighLine	5.5 - 25	
	Selection tables, Inverter Drives 8400 TopLine	5.5 - 32	
	Selection tables, Servo Drives ECS	5.5 - 38	
	Selection tables, Servo Inverter 9300	5.5 - 41	
	Torque characteristics	5.5 - 47	
	Dimensions, self-ventilated	5.5 - 66	
	Dimensions, forced ventilated	5.5 - 68	
	Accessories	Permanent magnet holding brake	5.5 - 75
		Spring-applied holding brake	5.5 - 78
Resolver		5.5 - 80	
Incremental encoder and SinCos absolute value encoder		5.5 - 81	
Blower		5.5 - 83	
Temperature monitoring		5.5 - 84	
Terminal box		5.5 - 85	
ICN connector	5.5 - 87		



List of abbreviations

$\eta_{100\%}$	[%]	Efficiency
$\cos \phi$		Power factor
du/dt	[kV/ μ s]	Insulation resistance
$F_{ax,-}$	[N]	Min. axial force
$F_{ax,+}$	[N]	Max. axial force
$f_{in,max}$	[Hz]	Max. input frequency
f_{max}	[kHz]	Limit frequency
f_{max}	[kHz]	Max. switching frequency
f_N	[Hz]	Rated frequency
F_{rad}	[N]	Max. radial force
H_{max}	[m]	Site altitude
I_0	[A]	Standstill current
I_{max}	[A]	Max. short-time DC-bus current
I_{max}	[A]	Max. current
I_{max}	[A]	Max. current consumption
I_{max}	[A]	Max. current
I_{max}	[A]	Max. DC-bus current
I_N	[A]	Rated current
J	[kgcm ²]	Moment of inertia
J_{MB}	[kgcm ²]	Moment of inertia
$KE_{LL\ 150\ ^\circ C}$	[V / (1000 r/min)]	Voltage constant
$Kt_{0\ 150\ ^\circ C}$	[Nm/A]	Torque constant
L	[mH]	Mutual inductance
$L_{1\sigma}$	[mH]	Stator leakage inductance
$L_{2\sigma}$	[mH]	Rotor leakage inductance
L_N	[mH]	Rated inductance
m	[kg]	Mass
M_0	[Nm]	Stall torque
$M_{0,max}$	[Nm]	Max. standstill torque
M_{av}	[Nm]	Average dynamic torque
M_{max}	[Nm]	Max. torque
M_N	[Nm]	Rated torque
n_{eto}	[r/min]	Transition speed
n_k	[r/min]	Speed
n_{max}	[r/min]	Max. speed

n_N	[r/min]	Rated speed
P_N	[kW]	Rated power
Q_E	[J]	Maximum switching energy
R	[Ω]	Insulation resistance
R	[Ω]	Min. insulation resistance
R_1	[Ω]	Stator impedance
R_2	[Ω]	Charging resistor
R_2	[Ω]	Rotor impedance
$R_{UV\ 150\ ^\circ C}$	[Ω]	Stator impedance
$R_{UV\ 20\ ^\circ C}$	[Ω]	Stator impedance
$S_{h\u00fc}$	[1/h]	Transition operating frequency
T	[$^\circ C$]	Operating temperature
T	[$^\circ C$]	Rated temperature
T	[$^\circ C$]	Max. ambient temperature of bearing
T	[$^\circ C$]	Max. surface temperature
T	[$^\circ C$]	Max. ambient temperature for transport
T	[$^\circ C$]	Min. ambient storage temperature
T	[$^\circ C$]	Min. ambient temperature for transport
T	[$^\circ C$]	Ambient temperature
t_1	[ms]	Engagement time
t_2	[ms]	Disengagement time
$T_{opr,max}$	[$^\circ C$]	Max. ambient operating temperature
$T_{opr,min}$	[$^\circ C$]	Min. ambient operating temperature
$U_{in,max}$	[V]	Max. input voltage
$U_{in,min}$	[V]	Min. input voltage
U_{max}	[V]	Max. mains voltage
U_{max}	[V]	Min. input voltage
U_{min}	[V]	Min. mains voltage
$U_{N, AC}$	[V]	Rated voltage
$U_{N, DC}$	[V]	Rated voltage
Z_{ro}	[Ω]	Rotor impedance
Z_{rs}	[Ω]	Impedance
Z_{so}	[Ω]	Stator impedance

MCA asynchronous servo motors

General information



List of abbreviations

CE	Communauté Européenne
CSA	Canadian Standards Association
DIN	Deutsches Institut für Normung e.V.
EMC	Electromagnetic compatibility
EN	European standard
EAC	Customs union Russia / Belarus / Kazakhstan certificate
IEC	International Electrotechnical Commission
IM	International Mounting Code
IP	International Protection Code
NEMA	National Electrical Manufacturers Association
UkrSEPRO	Certificate for Ukraine
UL	Underwriters Laboratory Listed Product
UR	Underwriters Laboratory Recognized Product
VDE	Verband deutscher Elektrotechniker (Association of German Electrical Engineers)

MCA asynchronous servo motors

General information



Product key

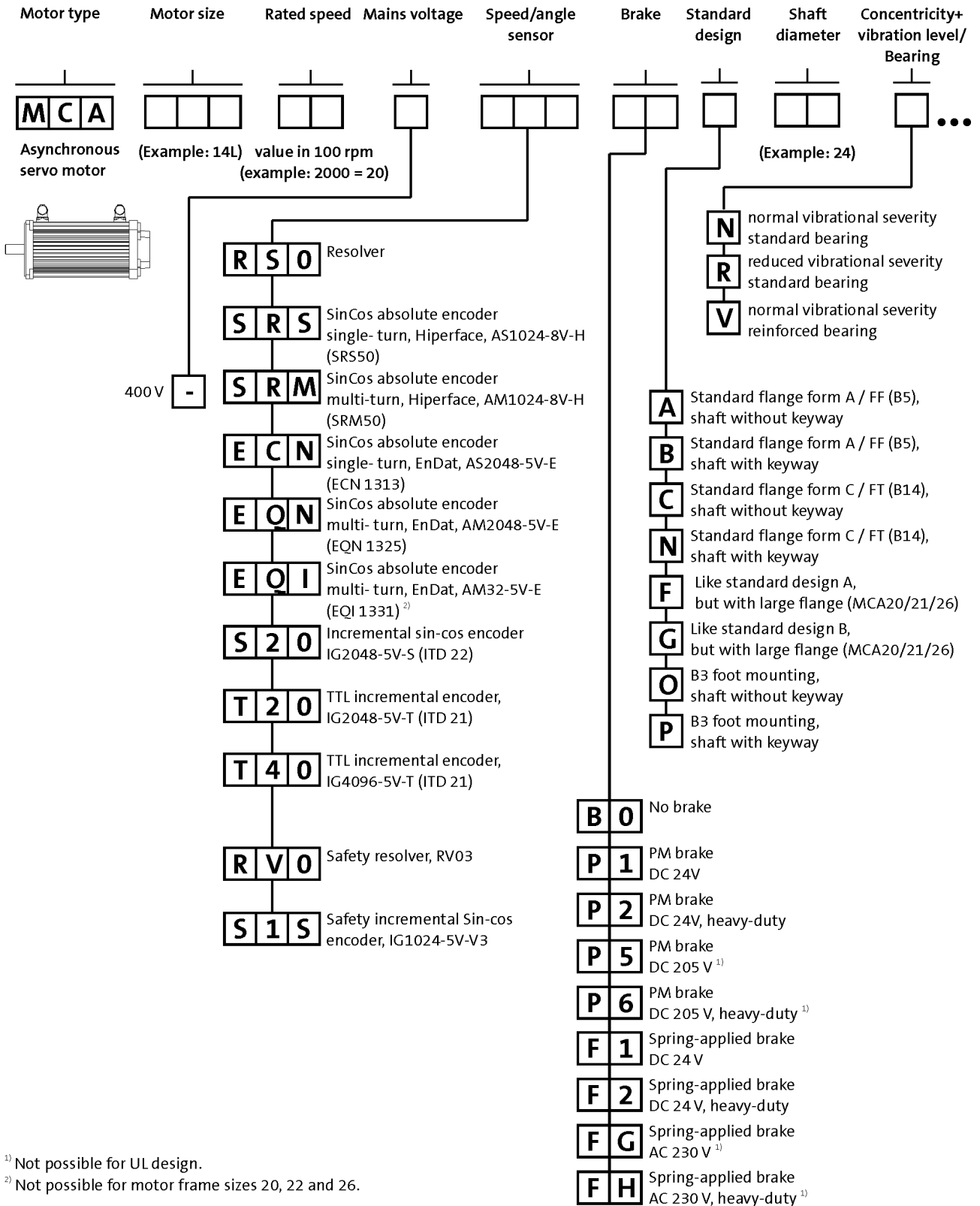

5.5

¹⁾ Not possible for UL design.

²⁾ Not possible for motor frame sizes 20, 22 and 26.

MCA asynchronous servo motors

General information



Product key

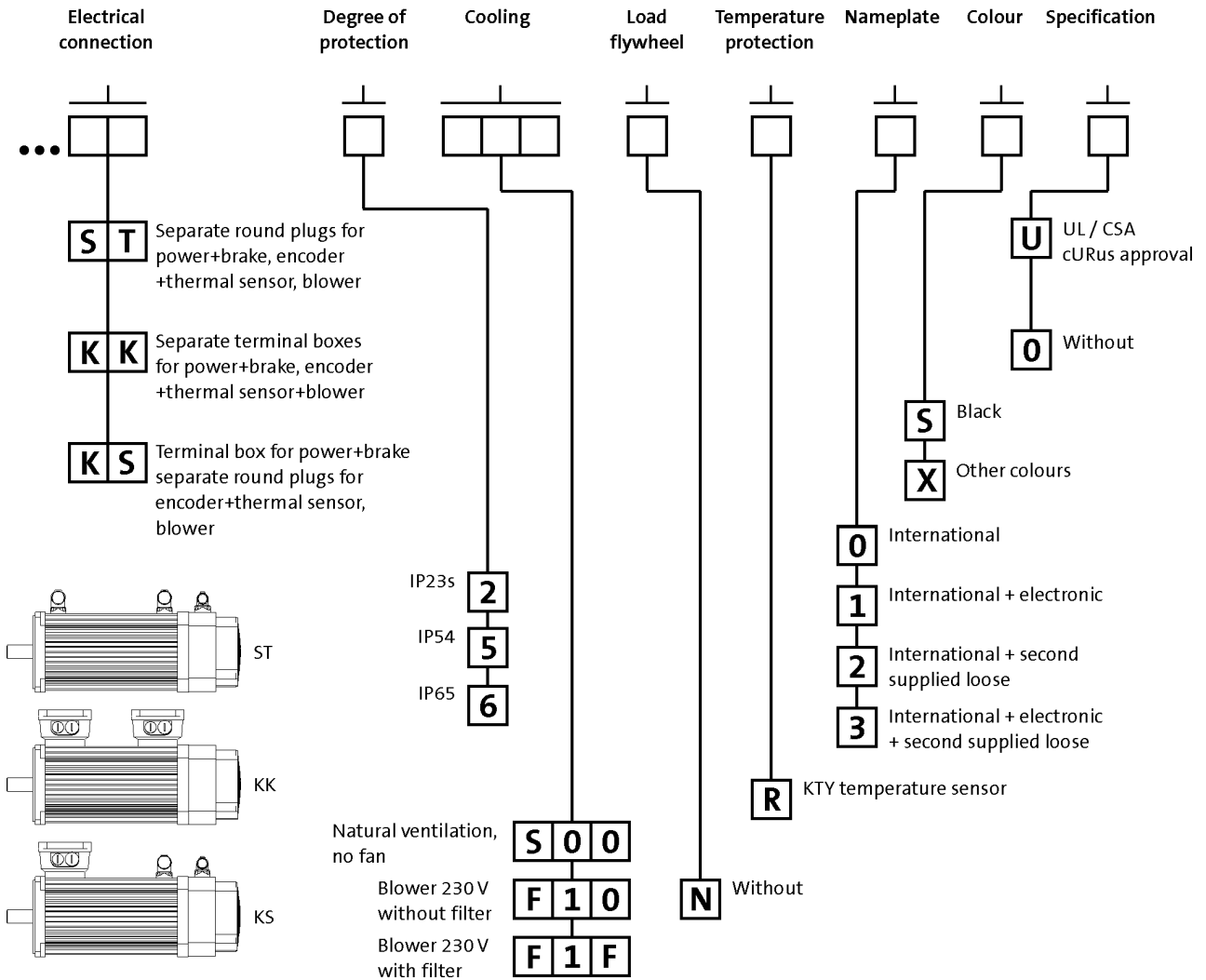

MCA asynchronous servo motors

General information



Product information

An application-oriented structure, low moments of inertia, compact dimensions and a high degree of intrinsic operational reliability characterise these robust and dynamic motors.

The compact design and the low moment of inertia allow these motors to be used in dynamic applications. If your application calls for a broad speed setting range and a robust construction, then the choice is easy: MCA asynchronous servo motors from Lenze.

Whether as a self-ventilated version or with a blower – with a power range from 0.8 to 53.8 kW, the MCA asynchronous servo motors offer rated torque values of up to 280 Nm and peak torque values of up to 1100 Nm. In comparison to standard three-phase AC motors, these servo motors have the edge in terms of lower moments of inertia, lower weight and higher maximum speeds.

Advantages

- High dynamic performance thanks to low moments of inertia
- Compact size with high power density
- Robust regenerative resolver system – alternatively SinCos and incremental encoder for the highest precision
- Easy to install and service friendly thanks to use of SpeedTec connectors
- Terminal box optional up to MCA21 MCA22 and 26 with three-part terminal box
- Protection: IP23, IP54, IP65 optional for naturally ventilated servo motors
- cURus-approved, GOST-certified, CE, RoHS-compliant
- High maximum speeds
- Wide speed setting range
- Field weakening operation usable
- Electronic nameplate

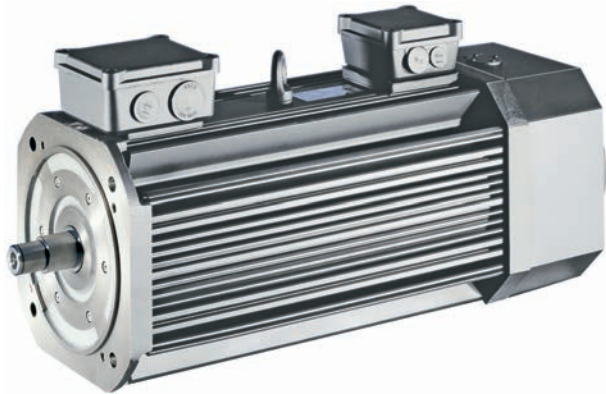

MCA21 asynchronous servo motor

MCA asynchronous servo motors

General information



Functions and features

	MCA10	MCA13	MCA14	MCA17	MCA19
Design					
	B14-FT85 B5-FF100	B14-FT130 B5-FF130	B14-FT130 B5-FF165		B14-FT130 B5-FF215
Shaft end (with and without keyway)					
	14 x 30	19 x 40	24 x 50		28 x 60
A end shield	Oil-tight Not oil-tight				
Brake					
Spring-applied brake					
Permanent magnetic brake	DC 24 V AC 230 V ¹⁾ DC 205 V ¹⁾				
Speed and angle encoder					
	Resolver SinCos single-turn/multi-turn Incremental encoder				
Cooling					
Without blower	Naturally ventilated				
Axial blower, 1 phase	230 V; 50 Hz				
Temperature sensor					
Thermal detector	KTY				
Motor connection: plug connector					
	Power + brake Encoder + thermal sensor Blower				
Motor connection: terminal box					
	Power + brake Encoder + thermal sensor	Power + brake Encoder + thermal sensor + blower			
Motor connection: Terminal box + plug connector					
Terminal box	Power + brake Encoder + thermal sensor				
Plug connector	Blower				
Shaft bearings					
Bearing type	Deep-groove ball bearing with high-temperature resistant grease, sealing disc or cover plate				
Position of the locating bearing	Drive end Standard motors (B3, B5, B14): side B Motors for gearbox direct mounting: side A				
Installation of the locating bearing					
Colour	RAL9005M				

¹⁾ Not possible for UR version.

MCA asynchronous servo motors

General information



Functions and features

	MCA20	MCA21	MCA22	MCA26
Design				
	B3 B35-FF215 B35-FF265	B14-FT130 B5-FF215 B5-FF265	B3 B35-FF265	B3 B35-FF265 B35-FF350
Shaft end (with and without keyway)	38 x 80			55 x 110
A end shield	Oil-tight Not oil-tight			
Brake				
Spring-applied brake	DC 24 V AC 230 V ¹⁾			DC 24 V AC 230 V ¹⁾
Permanent magnetic brake		DC 24 V AC 230 V ¹⁾ DC 205 V ¹⁾		
Speed and angle encoder	Resolver SinCos single-turn/multi-turn Incremental encoder			
Cooling				
Without blower		Naturally ventilated		
Axial blower, 1 phase	230 V; 50 Hz 230 V; 60 Hz	230 V; 50 Hz		230 V; 50 Hz 230 V; 60 Hz
Temperature sensor				
Thermal detector	KTY			
Motor connection: plug connector				
	Power + brake Encoder + thermal sensor Blower			
Motor connection: terminal box				
		Power + brake Encoder + thermal sensor + blower		
Motor connection: Terminal box + plug connector				
Terminal box	Power + brake	Power + brake Encoder + thermal sensor		Power + brake
Plug connector	Encoder + thermal sensor Blower	Blower		Encoder + thermal sensor Blower
Shaft bearings				
Bearing type	Deep-groove ball bearing with high-temperature resistant grease, sealing disc or cover plate			
Position of the locating bearing	Non-drive end	Drive end Standard motors (B3, B5, B14): side B Motors for gearbox dir- ect mounting: side A		Non-drive end
Installation of the locating bearing	insulation			insulation
Colour	RAL9005M			

¹⁾ Not possible for UR version.

MCA asynchronous servo motors



General information

Dimensioning

Speed-dependent safety functions

Single encoder concepts with resolvers

Servo motors can perform speed-dependent safety functions for safe speed and / or safe relative position monitoring in a drive system with the Servo Drives 9400. The SM301 safety module, which can be integrated in the Servo Drives 9400, is used to implement these functions. When planning systems/installations of this kind, the following must always be observed:

When using just one single feedback system in the environment of these safety applications, the applicable safety engineering standard IEC 61800-5-2 [Adjustable speed electrical power drive systems - Part: 5-2: Safety requirements - Functional] stipulates special requirements for the connection between feedback system and motor shaft. This is due to the fact that two-channel safety systems at this point in the mechanical system are actually designed as single-channel systems. If this mechanical connection is designed with considerable overdimensioning, the standard permits exclusion of the fault "encoder-shaft breakage" or "encoder-shaft slip". As such, acceleration limit values must not be exceeded for the individual drive solutions. You can find the limit values in the corresponding feedback data of the individual motor ranges.

Speed-dependent safety functions in connection with the SM301 safety module

For the following speed-dependent safety functions, the motor-feedback system combinations listed in the following table are available:

- Safe stop 1 (SS1)
- Safe operational stop (SOS)
- Safely Limited Speed (SLS)
- Safe Maximum Speed (SMS)
- Safe direction (SDI)
- Operation mode selector (OMS) with confirmation (ES)
- Safe speed monitor (SSM)
- Safely limited increment (SLI).

Encoder type	Encoder type	Product key	Feedback Design	Safe speed monitoring
SinCos incremental	Single-turn	IG1024-5V-V3	2-encoder concept	PL e/SIL 3 up to PL e / SIL 3
Resolver		RV03		

MCA asynchronous servo motors



General information

Dimensioning

Cooling effect of mounting flange

Mounting on a thermally conducting / insulating plate or machine chassis has an influence on heating up the motor, particularly when using naturally ventilated motors.

The motor rating data specified in the catalogue applies when mounting on a steel plate with free convection with the following dimensions:

- MCA10 / 13: 270 x 270 mm
- MCA14 / 17: 330 x 330 mm
- MCA19 to 26: 450 x 450 mm

Vibrational severity

		MCA10	MCA13	MCA14	MCA17	MCA19	MCA20	MCA21	MCA22	MCA26
Vibrational severity										
IEC/EN 60034-14		A			B		A	B		A
Maximum r.m.s. value of the vibration velocity ¹⁾	[mm/s]	1.60			0.70		1.60	0.70		1.60

¹⁾ Free suspension

- ▶ at n = 600 to 3,600 rpm



Dimensioning

Concentricity and axial run-out of the mounting flanges and smooth running of the shaft ends

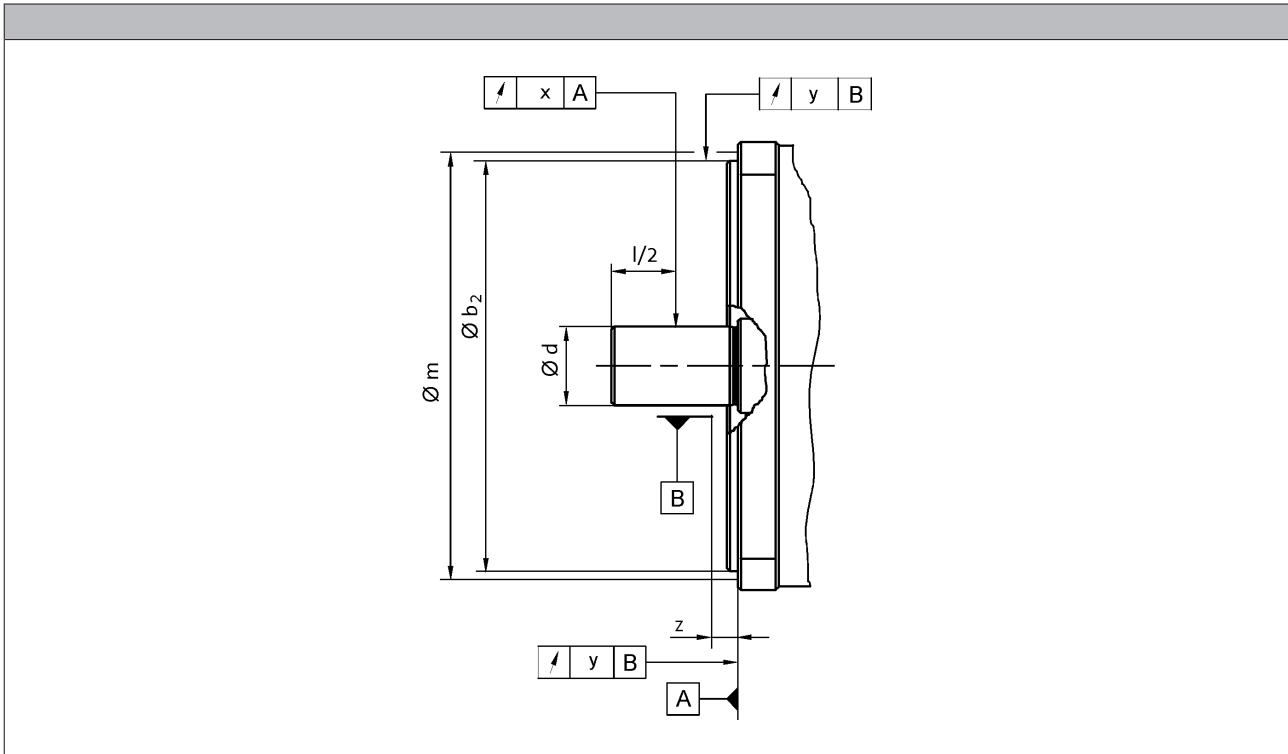

				MCA10		MCA13		MCA14		MCA17		MCA19	
Flange size				FF100	FT85	FF130	FT130	FF165	FT130	FF165	FT130	FF215	FT130
Dimensions	b_2	j6	[mm]	80	70	110		130	110	130	110	180	110
	b_2	h6	[mm]										
	d	k6	[mm]	14		19		24				28	
	d	m6	[mm]										
Distance													
Measuring diameter	m		[mm]	113	98.0	149		188	149	188	149	239	149
Dial gauge holder for flange check	z	+/- 1	[mm]	10.0									
Concentricity													
IEC 60072				Normal class				Precision class					
Value	y		[mm]	0.080		0.10		0.050					
Axial run-out													
IEC 60072				Normal class				Precision class					
Value	y		[mm]	0.080		0.10		0.050					
Smooth running													
IEC 60072				Normal class				Precision class					
Value	x		[mm]	0.035		0.040		0.021					

- Limit values for checking the smooth running of the shaft ends as well as the concentricity and axial run-out of the mounting flange to IEC 60072

MCA asynchronous servo motors

General information



Dimensioning

Concentricity and axial run-out of the mounting flanges and smooth running of the shaft ends

				MCA20		MCA21			MCA22	MCA26		
Flange size				FF215	FF265	FF215	FF265	FT130	FF265		FF350	
Dimensions												
	b ₂	j6	[mm]	180	230	180	230	110	230			
	b ₂	h6	[mm]								300	
	d	k6	[mm]	38								
	d	m6	[mm]								55	
Distance												
Measuring diameter	m		[mm]	239	289	239	289	149	289		384	
Dial gauge holder for flange check	z	+/- 1	[mm]	10.0								
Concentricity												
IEC 60072				Normal class		Precision class			Normal class			
Value	y		[mm]	0.10		0.050			0.10			
Axial run-out												
IEC 60072				Normal class		Precision class			Normal class			
Value	y		[mm]	0.10		0.050			0.10			
Smooth running												
IEC 60072				Normal class		Precision class			Normal class			
Value	x		[mm]	0.050		0.060			0.050	0.060		

- Limit values for checking the smooth running of the shaft ends as well as the concentricity and axial run-out of the mounting flange to IEC 60072



Dimensioning

Notes on the selection tables

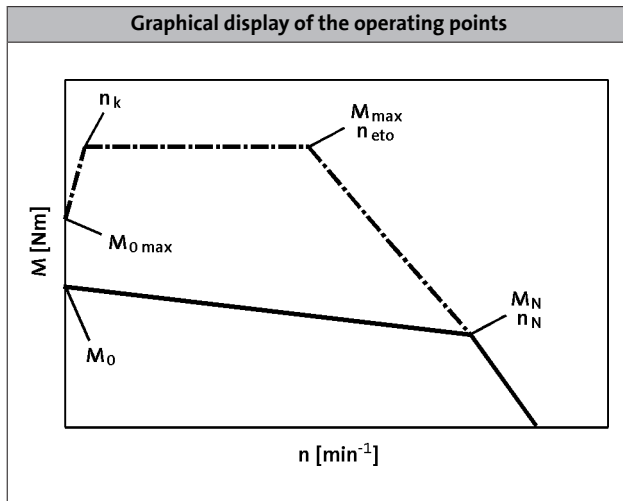

	n_k [r/min]
MCA	150
MQA	

Please note:

- With an active load (e.g. vertical drive axes, hoists, test benches, unwinders), $M_{0\max}$ must be taken into account
- With a passive load (e.g. horizontal drive axes), M_{\max} can generally be used
- At speeds $< n_k$, the inverter-specific torque $M_{0\max}$ that can be achieved is lower than M_{\max}
- On the servo inverters, the switching frequency-dependent overload capacity has been taken into account in the factory settings. For further information, please refer to the Servo-Inverters catalogue.

Further selection tables with different switching frequencies are available with the following codes:

- DS_ZT_MCS_0001
- DS_ZT_MCA_0001
- DS_ZT_MDSKS_0001
- DS_ZT_MDFKS_0001

Simply enter this code (e.g. DS_ZT_MCS_0001) as a search string at www.lenze.de/dsc and you will be given the information immediately in the form of a PDF format.



Dimensioning

Notes on the torque characteristics

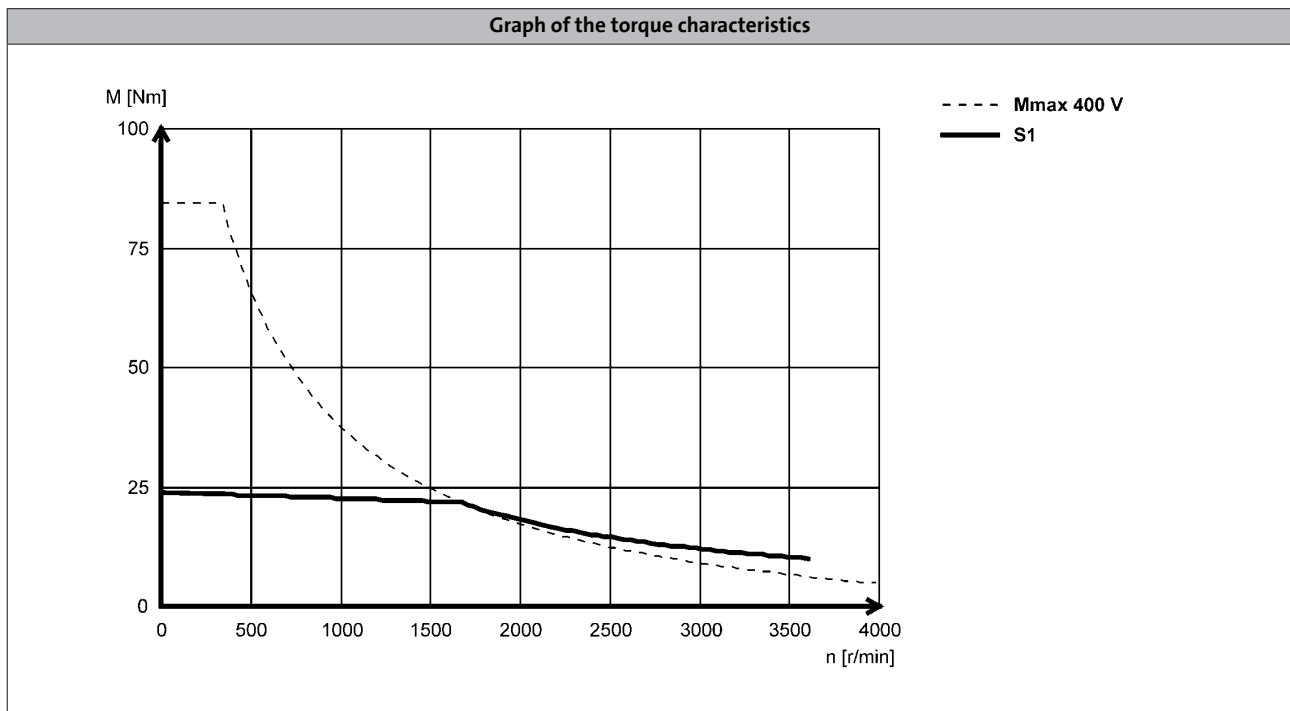

With asynchronous servo motors, two characteristics are shown in each case. The characteristics for continuous operation (S1) show the speed-dependent constant torque of the motor when operating with a servo inverter that itself is operated at a constant switching frequency. The limit torque characteristics correspond to those that come about during operation of the motor with the largest possible 9400 Servo Drive in each case (see selection tables). The servo inverter is set to a variable switching frequency here.

Characteristics in the Internet

Torque characteristics for selectable motor/inverter combinations can be determined in the EASY Product Finder in the Internet. The S1 continuous characteristic and the max. limit characteristic are generated. The result can be saved or printed in a PDF protocol. In the EASY Explorer, available torque characteristics are provided automatically.

Further information on the terms switching frequency and default setting can be found in the respective operating instructions of the servo inverter.



Dimensioning

Influence of ambient temperature and site altitude

The information relating to the servo motors in the tables and graphs is valid for a maximum ambient temperature (T_{opr}) of 40 °C and a site altitude (H) up to 1000 m above sea level. The torque correction factor (k_{M1}) shall be applied to the S1 torque characteristic ($M_0...M_N$) in the event of differing installation conditions.

- The maximum permissible ambient temperature (T_{opr}) for servo motors with blowers is 40 °C

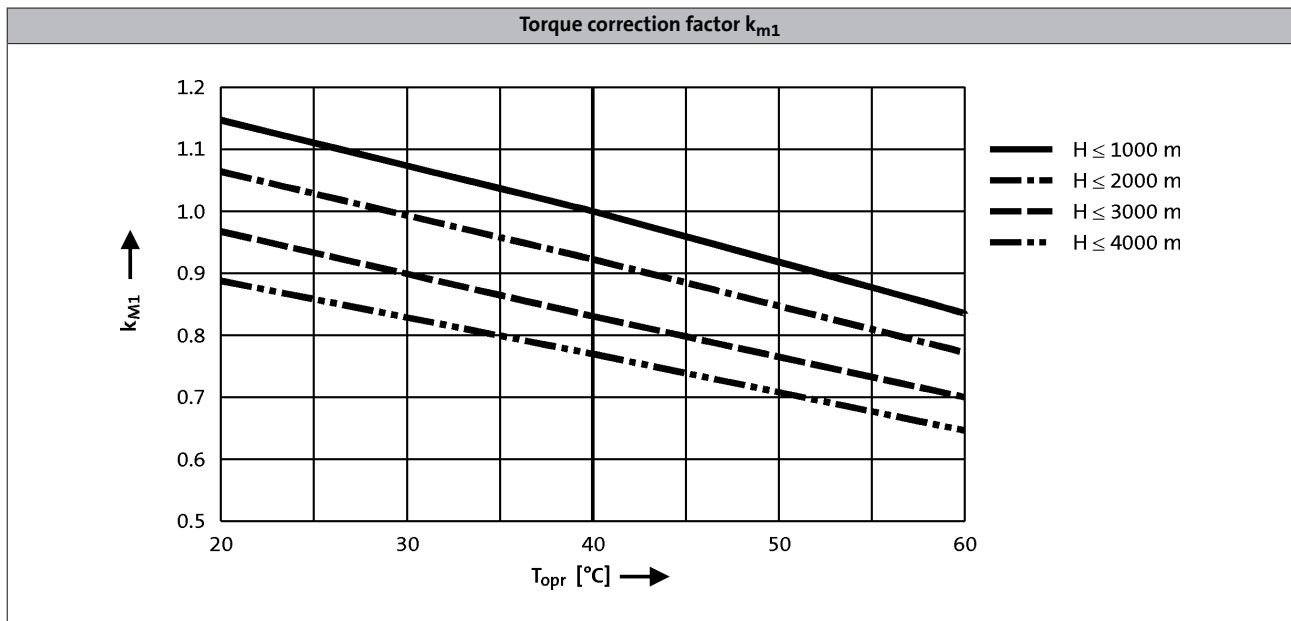

MCA asynchronous servo motors

General information



MCA asynchronous servo motors

Technical data



Standards and operating conditions

			MCA	
Cooling type			Naturally ventilated	Blower
Degree of protection				
EN 60529			IP54 IP65	IP54 IP23s ²⁾
Temperature class				
IEC/EN 60034-1; utilisation			F	
IEC/EN 60034-1; insulation system (enamel-insulated wire)			H	
Conformity				
CE			Low-Voltage Directive 2006/95/EC	
EAC			TP TC 004/2011 (TR CU 004/2011)	
Approval				
			UkrSEPRO	
CSA			CSA 22.2 No. 100	
cURus ³⁾			UL 1004-1 UL 1004-6 Power Conversion Equipment (File-No. E210321)	
Max. voltage load				
IEC/TS 60034-25			Pulse voltage limiting curve A	
Smooth running				
IEC 60072			Precision class ¹⁾ Normal class	
Axial run-out				
IEC 60072			Precision class ¹⁾ Normal class	
Concentricity				
IEC 60072			Precision class ¹⁾ Normal class	
Mechanical ambient conditions (vibration)				
IEC/EN 60721-3-3			3M6 3M6	
Min. ambient operating temperature				
Without brake	T _{opr,min}	[°C]	-20	-15
With brake	T _{opr,min}	[°C]	-10	
Max. ambient operating temperature				
	T _{opr,max}	[°C]	40	
Max. surface temperature				
	T	[°C]	140	110
Mechanical tolerance				
Flange centring diameter			b ₂ ≤ 230 mm = j6 b ₂ > 230 mm = h6	
Shaft diameter			d ≤ 50 mm = k6 d > 50 mm = m6	
Site altitude				
Amsl	H _{max}	[m]	4000	

¹⁾ MCA14, 17, 19 and 21.

²⁾ MCA20, 22 and 26.

³⁾ MCA20X29, MCA21X35 with circular connector for motor connection only
UR

5.5



Permissible radial and axial forces

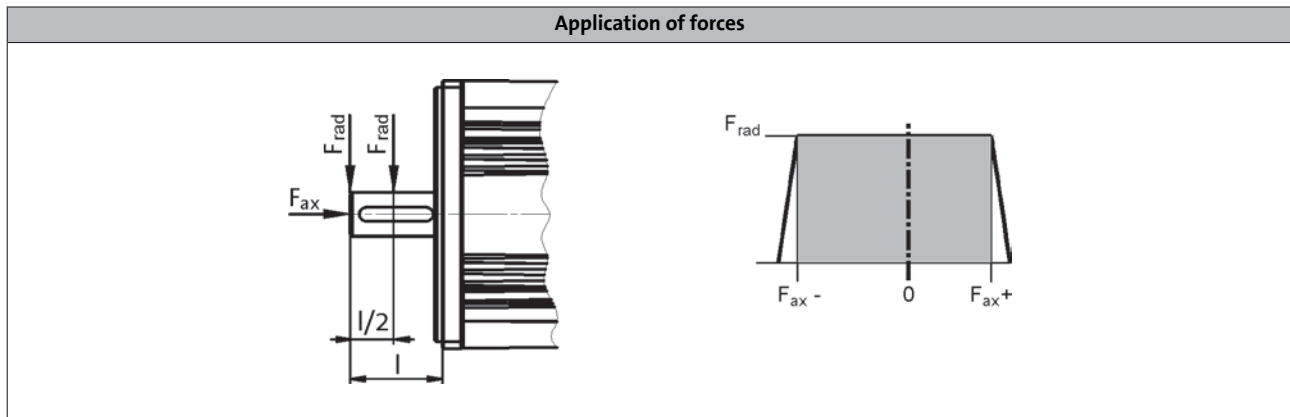

Application of force at l/2

	Bearing service life L_{10}														
	5000 h			10000 h			20000 h			30000 h			50000 h		
	F_{rad}	$F_{ax,-}$	$F_{ax,+}$	F_{rad}	$F_{ax,-}$	$F_{ax,+}$	F_{rad}	$F_{ax,-}$	$F_{ax,+}$	F_{rad}	$F_{ax,-}$	$F_{ax,+}$	F_{rad}	$F_{ax,-}$	$F_{ax,+}$
	[N]	[N]	[N]	[N]	[N]	[N]	[N]	[N]	[N]	[N]	[N]	[N]	[N]	[N]	[N]
MCA10	630	-130	320	500	-60	250	400	-30	210	330	-10	190	230	0	200
MCA13	850	-110	570	700	-10	450	470	0	450		0	450			
MCA14	1000	-140	500	780	-60	420	550	-30	380	400	-10	360	250	0	350
MCA17	1380	-180	790	1040	-70	680	660	-40	650	440	-20	630	280		610
MCA19	1880	-50	1530	1080	-30	1510	500	-100	1490	160	0	1470			
MCA20	3400	-1330	690	2500	-1020	380	1950	-780	140	1700	-690	40			
MCA21	3200	-260	1740	2360	-70	1550	1470	-20	1504	1030	0	1480			
MCA22	3600	-2370	1700	2800	-1740	1090	2200	-1280	640	1900	-1080	440	1600	-880	240
MCA26	6950	-2500	1580	5400	-1800	880	4300	-1300	380	3700	-1090	160			

5.5

Application of force at l

	Bearing service life L_{10}														
	5000 h			10000 h			20000 h			30000 h			50000 h		
	F_{rad}	$F_{ax,-}$	$F_{ax,+}$	F_{rad}	$F_{ax,-}$	$F_{ax,+}$	F_{rad}	$F_{ax,-}$	$F_{ax,+}$	F_{rad}	$F_{ax,-}$	$F_{ax,+}$	F_{rad}	$F_{ax,-}$	$F_{ax,+}$
	[N]	[N]	[N]	[N]	[N]	[N]	[N]	[N]	[N]	[N]	[N]	[N]	[N]	[N]	[N]
MCA10	590	-130	320	470	-60	250	370	-30	210	310	-10	190	220	0	200
MCA13	780	-110	570	640	-10	450	430	0	450	300	0	450			
MCA14	930	-140	500	710	-60	420	490	-30	380	370	-10	360	230	0	350
MCA17	1270	-180	790	960	-70	680	610	-40	650	400	-20	630	260		610
MCA19	1740	-50	1530	1000	-30	1510	420	-100	1490	140	0	1470			
MCA20	3150	-1170	530	2300	-920	280	1800	-710	70	1400	-650	0			
MCA21	2940	-260	1740	2160	-70	1550	1350	-20	1504	950	0	1480			
MCA22	3500	-2240	1600	2600	-1640	1100	2050	-1200	560	1800	-1020	380	1450	-850	200
MCA26	6400	-2080	1150	5000	-1600	680	4000	-1160	230	3400	-1090	50			

- The values for the bearing service life L_{10} relate to an average speed of 4000 r/min. For MCA20/22/26 the speed is 3000 r/min. Depending on the ambient temperatures, the service life of the bearings is also reduced by the grease lifetime.



Permissible radial and axial forces

- Reinforced bearings

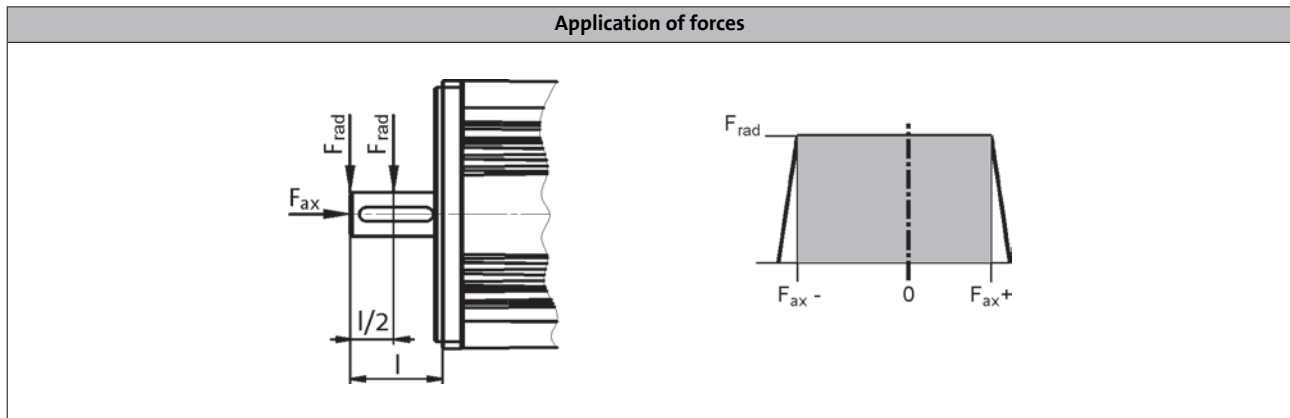

Application of force at l/2

	Bearing service life L_{10}														
	5000 h			10000 h			20000 h			30000 h			50000 h		
	F_{rad}	$F_{ax,-}$	$F_{ax,+}$	F_{rad}	$F_{ax,-}$	$F_{ax,+}$	F_{rad}	$F_{ax,-}$	$F_{ax,+}$	F_{rad}	$F_{ax,-}$	$F_{ax,+}$	F_{rad}	$F_{ax,-}$	$F_{ax,+}$
	[N]	[N]	[N]	[N]	[N]	[N]	[N]	[N]	[N]	[N]	[N]	[N]	[N]	[N]	[N]
MCA20	7100	-970	330	5100	-800	160	3900	-640	0						
MCA22	8500	-1850	1200	7000	-1400	760	5600	-1030	390	4350	-930	290	3200	-800	160
MCA26	10500	-2180	1250	8370	-1530	600	6670	-1130	200	5840	-960	30			

Application of force at l

	Bearing service life L_{10}														
	5000 h			10000 h			20000 h			30000 h			50000 h		
	F_{rad}	$F_{ax,-}$	$F_{ax,+}$	F_{rad}	$F_{ax,-}$	$F_{ax,+}$	F_{rad}	$F_{ax,-}$	$F_{ax,+}$	F_{rad}	$F_{ax,-}$	$F_{ax,+}$	F_{rad}	$F_{ax,-}$	$F_{ax,+}$
	[N]	[N]	[N]	[N]	[N]	[N]	[N]	[N]	[N]	[N]	[N]	[N]	[N]	[N]	[N]
MCA20	6350	-720	80	4100	-680	40	2800	-640	0						
MCA22	7000	-1750	1100	5500	-1300	660	4700	-920	280	3900	-820	180	3000	-700	60
MCA26	9600	-2200	1280	7700	-1280	360	6000	-960	30						

- The values for the bearing service life L_{10} refer to an average speed of 3000 r/min. Depending on the ambient temperatures, the service life of the bearings is also reduced by the grease life-time.

MCA asynchronous servo motors

Technical data



Rated data, non-ventilated

► The data applies to a mains connection voltage of 3 x 400 V.

	n_N [r/min]	M_0 [Nm]	M_N [Nm]	M_{max} [Nm]	P_N [kW]	I_0 [A]	I_N [A]	$U_{N, AC}$ [V]	f_N [Hz]	$J^{1)}$ [kgcm ²]	$\eta_{100\%}$ [%]
MCA10I40	3950	2.30	2.00	10.0	0.80	2.60	2.40	390	140	2.40	0.70
MCA13I41	4050	4.60	4.00	32.0	1.70	4.60	4.40	390	140	8.30	75.0
MCA14L20	2000	8.00	6.70	60.0	1.40	3.90	3.30	390	70	19.2	84.0
MCA14L41	4100	8.00	5.40	60.0	2.30	7.70	5.80	390	140	19.2	78.0
MCA17N23	2300	12.8	10.8	100	2.60	6.00	5.50	390	80	36.0	86.0
MCA17N41	4110	12.8	9.50	100	4.10	12.0	10.2	350	140	36.0	83.0
MCA19S23	2340	22.5	16.3	180	4.00	9.90	8.20	390	80	72.0	90.0
MCA19S42	4150	22.5	12.0	180	5.20	19.7	14.0	330	140	72.0	83.0
MCA21X25	2490	39.0	24.6	300	6.40	15.9	13.5	390	85	180	85.0
MCA21X42	4160	39.0	17.0	300	7.40	31.8	19.8	320	140	180	84.0

	R_1 [Ω]	$R_{UV\ 20\ ^\circ C}$ [Ω]	$R_{UV\ 150\ ^\circ C}$ [Ω]	R_2 [Ω]	$L_{1\sigma}$ [mH]	L [mH]	$L_{2\sigma}$ [mH]	$n_{max}^{2)}$ [r/min]	$m^{1)}$ [kg]
MCA10I40	4.70	9.40	12.7	5.20	9.80	169	10.0	8000	6.40
MCA13I41	1.70	3.40	4.60	1.41	5.40	92.6	4.90		10.4
MCA14L20	3.00	6.00	8.10	3.13	10.0	269	10.0		15.1
MCA14L41	0.75	1.50	2.00	0.78	2.50	65.8	2.50		22.9
MCA17N23	1.52	3.04	4.10	1.37	6.20	176	6.80		
MCA17N41	0.38	0.76	1.00	0.34	1.50	43.4	1.70		44.7
MCA19S23	0.69	1.38	1.90	0.62	3.20	111	3.90		
MCA19S42	0.18	0.35	0.50	0.15	0.80	28.0	1.00		60.0
MCA21X25	0.36	0.72	1.00	0.36	2.30	78.1	2.80		
MCA21X42	0.090	0.18	0.20	0.090	0.60	19.5	0.70		

5.5

¹⁾ Without brake.

²⁾ Mechanically permissible maximum speed.

The data in the R_1 , $L_{1\sigma}$, L , R_2' and $L_{2\sigma}'$ columns is based on a single-phase equivalent circuit diagram at 20°C.

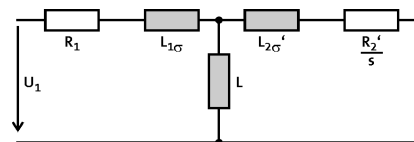

MCA asynchronous servo motors

Technical data



Rated data, IP54 forced ventilated

► The data applies to a mains connection voltage of 3 x 400 V.

	n_N [r/min]	M_0 [Nm]	M_N [Nm]	M_{max} [Nm]	P_N [kW]	I_0 [A]	I_N [A]	$U_{N, AC}$ [V]	f_N [Hz]	$J^{1)}$ [kgcm ²]	$\eta_{100\%}$ [%]
MCA13I34	3410	7.00	6.30	32.0	2.20	6.30	6.00	390	120	8.30	72.0
MCA14L16	1635	13.5	12.0	60.0	2.10	5.30	4.80	390	60	19.2	80.0
MCA14L35	3455	13.5	10.8	60.0	3.90	10.5	9.10	390	120	19.2	79.0
MCA17N17	1680	23.9	21.5	100	3.80	9.10	8.50	390	60	36.0	83.0
MCA17N35	3480	23.9	19.0	100	6.90	18.1	15.8	390	120	36.0	81.0
MCA19S17	1700	40.0	36.3	180	6.40	15.4	13.9	390	60	72.0	82.0
MCA19S35	3510	40.0	36.0	180	13.2	30.8	28.7	390	120	72.0	85.0
MCA21X17	1710	75.0	61.4	300	11.0	25.8	22.5	390	60	180	85.0
MCA21X35	3520	75.0	55.0	300	20.3	49.5	42.5	390	120	180	88.0
MCA22P08...5F□□	760	120	110	500	8.75	23.4	22.1	345	28	487	80.0
MCA22P14...5F□□	1425	120	107	500	16.0	40.5	37.7	350	50	487	87.0
MCA22P17...5F□□	1670	120	106	500	18.5	46.7	42.7	360	58	487	88.0
MCA22P29...5F□□	2935	120	100	500	30.7	80.9	72.1	360	100	487	87.0
MCA26T05...5F□□	550	220	216	1100	12.4	35.4	34.9	350	19	1335	83.0
MCA26T10...5F□□	1030	220	210	1100	22.7	62.9	61.5	350	36	1335	88.0
MCA26T12...5F□□	1200	220	207	1100	26.0	78.4	75.1	350	41	1335	87.0
MCA26T22...5F□□	2235	220	195	1100	45.6	125	113	340	76	1335	92.0

	R_1 [Ω]	$R_{UV\ 20^\circ C}$ [Ω]	$R_{UV\ 150^\circ C}$ [Ω]	R_2 [Ω]	$L_{1\sigma}$ [mH]	L [mH]	$L_{2\sigma}$ [mH]	$n_{max}^{2)}$ [r/min]	$m^{1)}$ [kg]	
MCA13I34	1.70	3.40	4.60	1.41	4.90	76.7	4.40	8000	12.0	
MCA14L16	3.00	6.00	8.10	3.13	9.50	224	9.30		16.9	
MCA14L35	0.75	1.50	2.00	0.78	2.40	56.7	2.30		25.5	
MCA17N17	1.52	3.04	4.10	1.37	5.60	144	6.00		48.2	
MCA17N35	0.38	0.76	1.00	0.34	1.40	36.9	1.50		63.5	
MCA19S17	0.69	1.38	1.90	0.62	2.60	80.9	3.10		6500	105
MCA19S35	0.18	0.35	0.50	0.15	0.70	20.3	0.80			
MCA21X17	0.36	0.72	1.00	0.36	2.10	68.9	2.60			
MCA21X35	0.090	0.18	0.20	0.090	0.50	16.8	0.60		5500	194
MCA22P08...5F□□	0.54	1.07	1.62	0.48	3.56	94.9	4.80			
MCA22P14...5F□□		0.36	0.54		3.60	94.2	4.85			
MCA22P17...5F□□	0.13	0.27	0.40	0.12	0.90	23.4	1.21			
MCA22P29...5F□□		0.080	0.12		22.9					
MCA26T05...5F□□	0.29	0.59	0.89	0.25	2.86	66.8	5.04			
MCA26T10...5F□□		0.20	0.30		2.93	69.2	5.12			
MCA26T12...5F□□	0.080	0.15	0.23	0.062	0.74	18.1	1.29			
MCA26T22...5F□□		0.050	0.075		0.78	19.8				

1) Without brake.

2) Mechanically permissible maximum speed.

The permanent speed in case of MCA20, 22 and 26 is limited to 70% of the value.

The data in the R_1 , $L_{1\sigma}$, L , R_2' and $L_{2\sigma}'$ columns is based on a single-phase equivalent circuit diagram at 20°C.

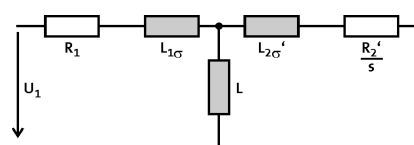

MCA asynchronous servo motors

Technical data



Rated data, IP23s forced ventilated

► The data applies to a mains connection voltage of 3 x 400 V.

	n_N [r/min]	M_0 [Nm]	M_N [Nm]	M_{max} [Nm]	P_N [kW]	I_0 [A]	I_N [A]	$U_{N, AC}$ [V]	f_N [Hz]	$J^{1)}$ [kgcm ²]	$\eta_{100\%}$ [%]
MCA20X14...2F□□	1420	68.0	61.0	250	9.07	26.0	23.0	350	50	171	82.0
MCA20X29...2F□□	2930	68.0	53.5	250	16.4	52.0	42.4	350	100	171	87.0
MCA22P08...2F□□	760	135	120	500	9.55	26.0	23.5	355	28	487	80.0
MCA22P14...2F□□	1425	135	115	500	17.2	45.1	40.0	360	50	487	86.0
MCA22P17...2F□□	1670	135	112	500	19.6	52.1	44.5	360	58	487	88.0
MCA22P29...2F□□	2935	135	110	500	33.8	90.2	77.8	360	100	487	89.0
MCA26T05...2F□□	550	290	280	1100	16.1	44.0	42.4	350	20	1335	81.0
MCA26T10...2F□□	1030	290	260	1100	28.0	78.0	69.6	350	36	1335	87.0
MCA26T12...2F□□	1200	290	255	1100	32.0	101	83.3	350	41	1335	87.0
MCA26T22...2F□□	2235	290	230	1100	53.8	160	127	340	76	1335	92.0

	R_1 [Ω]	$R_{UV\ 20\ ^\circ C}$ [Ω]	$R_{UV\ 150\ ^\circ C}$ [Ω]	R_2 [Ω]	$L_{1\sigma}$ [mH]	L [mH]	$L_{2\sigma}$ [mH]	$n_{max}^{2)}$ [r/min]	$m^{1)}$ [kg]
MCA20X14...2F□□	0.37	0.73	1.10	0.36	2.01	60.2	2.14	6500	64.0
MCA20X29...2F□□	0.090	0.18	0.28	0.090	0.50	14.3	0.54		
MCA22P08...2F□□	0.54	1.07	1.62	0.48	3.50	91.9	4.74		
MCA22P14...2F□□		0.36	0.54		3.55	90.9	4.79		
MCA22P17...2F□□	0.13	0.27	0.40	0.12	0.90	23.5	1.22		
MCA22P29...2F□□		0.080	0.12		22.9	1.21			
MCA26T05...2F□□	0.29	0.59	0.89	0.25	3.11	72.1	5.08	5500	194
MCA26T10...2F□□		0.20	0.30		3.17	71.4	5.14		
MCA26T12...2F□□	0.080	0.15	0.23	0.062	0.78	18.6	1.30		
MCA26T22...2F□□		0.050	0.077		20.2				

5.5

¹⁾ Without brake.

²⁾ Mechanically permissible maximum speed.

The permanent speed in case of MCA20, 22 and 26 is limited to 70% of the value.

The data in the R_1 , $L_{1\sigma}$, L , R_2' and $L_{2\sigma}'$ columns is based on a single-phase equivalent circuit diagram at 20°C.

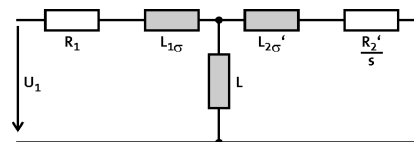

MCA asynchronous servo motors

Technical data



Selection tables, Servo Drives 9400 HighLine

Non-ventilated motors

- The data applies to a mains connection voltage of 3 x 400 V and an inverter switching frequency of 4 kHz.

					E94A□□	E0024	E0034	E0044	E0074	E0094	E0134	E0174	E0244	E0324
					I_N	1.9	3.1	5.0	8.8	11.7	16.3	20.6	29.4	38.4
					$I_{0,max}$	6.0	10.0	16.0	21.0	28.0	39.0	49.5	58.8	76.8
MCA	M_N	n_N	I_N	P_N	I_{max}	6.0	10.0	16.0	21.0	28.0	39.0	49.5	58.8	76.8
10I40	2.0	3950	2.4	0.80	M_0	1.1	2.3							
					M_N	1.0	2.0							
					$M_{0,max}$	6.9	10.0							
					M_{max}	6.9	10.0							
					η_{eto}	-	-							
13I41	4.0	4050	4.4	1.70	M_0			4.6	4.6					
					M_N			4.0	4.0					
					$M_{0,max}$			18.9	20.8					
					M_{max}			18.9	20.8					
					η_{eto}			-	-					
14L20	6.7	2000	3.3	1.40	M_0		5.1	8.0						
					M_N		4.4	6.7						
					$M_{0,max}$		25.0	42.8						
					M_{max}		25.0	42.8						
					η_{eto}		-	-						
14L41	5.4	4100	5.8	2.30	M_0			3.5	8.0	8.0				
					M_N			3.5	5.4	5.4				
					$M_{0,max}$			21.5	27.0	31.3				
					M_{max}			21.5	27.0	31.3				
					η_{eto}			-	-	-				
17N23	10.8	2300	5.5	2.60	M_0			9.5	12.8					
					M_N			9.0	10.8					
					$M_{0,max}$			38.0	50.0					
					M_{max}			38.0	50.0					
					η_{eto}			-	-					
17N41	9.5	4110	10.2	4.10	M_0			7.1	11.5	12.8	12.8			
					M_N			6.7	9.5	9.5	9.5			
					$M_{0,max}$			24.0	33.3	45.8	49.9			
					M_{max}			24.0	33.3	45.8	49.9			
					η_{eto}			-	-	-	-			
19S23	16.3	2340	8.2	4.00	M_0			18.4	22.5	22.5				
					M_N			15.6	16.3	16.3				
					$M_{0,max}$			55.0	73.7	86.0				
					M_{max}			55.0	73.7	86.0				
					η_{eto}			-	-	-				
19S42	12.0	4150	14.0	5.20	M_0					15.0	22.5	22.5		
					M_N					12.0	12.0	12.0		
					$M_{0,max}$					48.8	62.0	70.0		
					M_{max}					48.8	62.0	70.0		
					η_{eto}					-	-	-		
21X25	24.6	2490	13.5	6.40	M_0					21.4	39.0	39.0	39.0	
					M_N					19.6	24.6	24.6	24.6	
					$M_{0,max}$					71.7	96.0	126.0	136.0	
					M_{max}					71.7	96.0	126.0	136.0	
					η_{eto}					-	-	-	-	

- $I...$ [A], $M...$ [Nm], $n...$ [r/min], $P...$ [kW]

MCA asynchronous servo motors

Technical data



Selection tables, Servo Drives 9400 HighLine

Non-ventilated motors

- The data applies to a mains connection voltage of 3 x 400 V and an inverter switching frequency of 4 kHz.

					E94A□□	E0024	E0034	E0044	E0074	E0094	E0134	E0174	E0244	E0324
					I_N	1.9	3.1	5.0	8.8	11.7	16.3	20.6	29.4	38.4
					$I_{0,max}$	6.0	10.0	16.0	21.0	28.0	39.0	49.5	58.8	76.8
MCA	M_N	n_N	I_N	P_N	I_{max}	6.0	10.0	16.0	21.0	28.0	39.0	49.5	58.8	76.8
21X42	17.0	4160	19.8	7.40	M_0								31.3	39.0
					M_N								17.0	17.0
					$M_{0,max}$								71.7	91.0
					M_{max}								71.7	91.0
					η_{eto}									-

- I_N [A], M_N [Nm], n_N [r/min], P_N [kW]

MCA asynchronous servo motors

Technical data



Selection tables, Servo Drives 9400 HighLine

Forced ventilated IP54 motors

- The data applies to a mains connection voltage of 3 x 400 V and an inverter switching frequency of 4 kHz.

					E94A□□	E0044	E0074	E0094	E0134	E0174	E0244	E0324	E0474	E0594	E0864
					I _N	5.0	8.8	11.7	16.3	20.6	29.4	38.4	47.0	59.0	86.0
					I _{0,max}	16.0	21.0	28.0	39.0	49.5	58.8	76.8	94.0	118.0	172.0
MCA	M _N	n _N	I _N	P _N	I _{max}	16.0	21.0	28.0	39.0	49.5	58.8	76.8	94.0	118.0	172.0
13I34	6.3	3410	6.0	2.20	M ₀	4.6	7.0	7.0							
					M _N	4.4	6.3	6.3							
					M _{0,max}	20.8	26.0	29.2							
					M _{max}	20.8	26.0	29.2							
					η _{eto}	-	-	-							
14L16	12.0	1635	4.8	2.10	M ₀	12.0	13.5								
					M _N	12.0	12.0								
					M _{0,max}	45.4	52.6								
					M _{max}	45.4	52.6								
					η _{eto}	-	-								
14L35	10.8	3455	9.1	3.90	M ₀		10.1	13.5	13.5						
					M _N		9.7	10.8	10.8						
					M _{0,max}		32.4	46.0	60.0						
					M _{max}		32.4	46.0	60.0						
					η _{eto}		-	-	-						
17N17	21.5	1680	8.5	3.80	M ₀		21.6	23.9	23.9						
					M _N		21.5	21.5	21.5						
					M _{0,max}		59.4	81.4	84.5						
					M _{max}		59.4	81.4	84.5						
					η _{eto}		-	-	-						
17N35	19.0	3480	15.8	6.90	M ₀				19.4	23.9	23.9				
					M _N				19.0	19.0	19.0				
					M _{0,max}				59.2	75.0	90.0				
					M _{max}				59.2	75.0	90.0				
					η _{eto}				-	-	-				
19S17	36.3	1700	13.9	6.40	M ₀				40.0	40.0	40.0				
					M _N				36.3	36.3	36.3				
					M _{0,max}				105.0	133.0	148.0				
					M _{max}				105.0	133.0	148.0				
					η _{eto}				-	-	-				
19S35	36.0	3510	28.7	13.20	M ₀						36.9	40.0	40.0	40.0	
					M _N						36.0	36.0	36.0	36.0	
					M _{0,max}						82.0	112.0	132.0	160.0	
					M _{max}						82.0	112.0	132.0	160.0	
					η _{eto}						-	-	-	-	
21X17	61.4	1710	22.5	11.00	M ₀					54.4	75.0	75.0	75.0		
					M _N					50.4	61.4	61.4	61.4		
					M _{0,max}					134.0	158.0	215.0	246.0		
					M _{max}					134.0	158.0	215.0	246.0		
					η _{eto}					-	-	-	-		
21X35	55.0	3520	42.5	20.30	M ₀								63.9	75.0	75.0
					M _N								55.0	55.0	55.0
					M _{0,max}								134.0	167.0	232.0
					M _{max}								134.0	167.0	232.0
					η _{eto}								-	-	-

- I... [A], M... [Nm], n... [r/min], P... [kW]

MCA asynchronous servo motors

Technical data



Selection tables, Servo Drives 9400 HighLine

Forced ventilated IP54 motors

- The data applies to a mains connection voltage of 3 x 400 V and an inverter switching frequency of 8 kHz.

					E94A□□	E0174	E0244	E0324	E0474	E0594	E0864	E1044	E1454	E1724	E2024	E2454	
					I _N	16.5	23.5	32.0	41.0	41.0	73.0	78.0	102.0	120.0	131.0	160.0	
					I _{0,max}	49.5	58.8	76.8	94.0	118.0	172.0	208.0	261.0	310.0	364.0	441.0	
MCA	M _N	n _N	I _N	P _N	I _{max}	49.5	58.8	76.8	94.0	118.0	172.0	208.0	261.0	310.0	364.0	441.0	
22P08-...5F□□	110.0	760	22.1	8.80	M ₀	64.0	110.0	120.0									
					M _N	64.0	110.0	110.0									
					M _{0,max}	261.0	313.0	402.0									
					M _{max}	261.0	313.0	402.0									
					η _{eto}	-	-	-									
22P14-...5F□□	107.0	1425	37.7	16.00	M ₀			82.0	120.0	120.0							
					M _N			82.0	107.0	107.0							
					M _{0,max}			242.0	300.0	372.0							
					M _{max}			242.0	300.0	372.0							
					η _{eto}			-	-	-							
22P17-...5F□□	105.0	1670	42.7	18.50	M ₀					99.0	120.0						
					M _N					99.0	106.0						
					M _{0,max}					325.0	463.0						
					M _{max}					325.0	463.0						
					η _{eto}					-	-						
22P29-...5F□□	100.0	2935	72.1	30.70	M ₀							110.0	120.0	120.0			
					M _N							100.0	100.0	100.0			
					M _{0,max}							335.0	416.0	465.0			
					M _{max}							335.0	416.0	465.0			
					η _{eto}							-	-	-			
26T05-...5F□□	216.0	550	34.9	12.40	M ₀			191.0	220.0	220.0	220.0						
					M _N			191.0	216.0	216.0	216.0						
					M _{0,max}			531.0	665.0	826.0	1010.0						
					M _{max}			531.0	665.0	826.0	1010.0						
					η _{eto}			-	-	-	-						
26T10-...5F□□	210.0	1030	61.5	22.70	M ₀					77.0	220.0	220.0	220.0				
					M _N					77.0	210.0	210.0	210.0				
					M _{0,max}					472.0	713.0	855.0	1044.0				
					M _{max}					472.0	713.0	855.0	1044.0				
					η _{eto}					-	-	-	-				
26T12-...5F□□	207.0	1200	75.1	26.00	M ₀						204.0	219.0	220.0	220.0			
					M _N						204.0	207.0	207.0	207.0			
					M _{0,max}						502.0	609.0	739.0	819.0			
					M _{max}						502.0	609.0	739.0	819.0			
					η _{eto}						-	-	-	-			
26T22-...5F□□	195.0	2235	112.9	45.60	M ₀								154.0	211.0	220.0	220.0	
					M _N									154.0	195.0	195.0	195.0
					M _{0,max}									523.0	611.0	711.0	843.0
					M _{max}									523.0	611.0	711.0	843.0
					η _{eto}									-	-	-	-

- I... [A], M... [Nm], n... [r/min], P... [kW]
- If the motors are operated at a lower switching frequency, please contact your Lenze sales office!
- When operating at 4 kHz, the motor generates just 95 % of its rated torque with increased noise emissions.

5.5

MCA asynchronous servo motors

Technical data



Selection tables, Servo Drives 9400 HighLine

Forced ventilated IP23s motors

- The data applies to a mains connection voltage of 3 x 400 V and an inverter switching frequency of 8 kHz.

					E94A□□	E0174	E0244	E0324	E0474	E0594	E0864	E1044	E1454	E1724	E2024	E2454	E2924
					I _N	16.5	23.5	32.0	41.0	41.0	73.0	78.0	102.0	120.0	131.0	160.0	191.0
					I _{0,max}	49.5	58.8	76.8	94.0	118.0	172.0	208.0	261.0	310.0	364.0	441.0	526.0
MCA	M _N	n _N	I _N	P _N	I _{max}	49.5	58.8	76.8	94.0	118.0	172.0	208.0	261.0	310.0	364.0	441.0	526.0
20X14-...2F□□	61.0	1420	23.0	9.10	M ₀	32.5	66.0										
					M _N	32.5	61.0										
					M _{0,max}	154.2	190.0										
					M _{max}	154.2	190.0										
					η _{eto}	-	-										
20X29-...2F□□	53.5	2930	42.4	16.40	M ₀			28.0	51.6	51.6							
					M _N			28.0	51.6	51.6							
					M _{0,max}			116.0	148.2	192.8							
					M _{max}			116.0	148.2	192.8							
					η _{eto}			-	-	-							
22P08-...2F□□	120.0	760	23.5	9.60	M ₀		120.0	135.0									
					M _N		120.0	120.0									
					M _{0,max}		313.0	402.0									
					M _{max}		313.0	402.0									
					η _{eto}		-	-									
22P14-...2F□□	115.0	1425	40.0	17.20	M ₀				118.0	118.0							
					M _N				115.0	115.0							
					M _{0,max}				300.0	372.0							
					M _{max}				300.0	372.0							
					η _{eto}				-	-							
22P17-...2F□□	112.0	1670	44.5	19.60	M ₀					99.0	135.0						
					M _N					99.0	112.0						
					M _{0,max}					325.0	463.0						
					M _{max}					325.0	463.0						
					η _{eto}					-	-						
22P29-...2F□□	110.0	2935	77.8	33.80	M ₀							110.0	135.0	135.0			
					M _N							110.0	110.0	110.0			
					M _{0,max}							335.0	416.0	486.0			
					M _{max}							335.0	416.0	486.0			
					η _{eto}							-	-	-			
26T05-...2F□□	280.0	550	42.4	16.10	M ₀				268.0	268.0	290.0						
					M _N				268.0	268.0	280.0						
					M _{0,max}				665.0	826.0	1100.0						
					M _{max}				665.0	826.0	1100.0						
					η _{eto}				-	-	-						
26T10-...2F□□	260.0	1030	69.6	28.00	M ₀						270.0	290.0	290.0				
					M _N						260.0	260.0	260.0				
					M _{0,max}						713.0	855.0	1044.0				
					M _{max}						713.0	855.0	1044.0				
					η _{eto}						-	-	-				

- I... [A], M... [Nm], n... [r/min], P... [kW]
- If the motors are operated at a lower switching frequency, please contact your Lenze sales office!
- When operating at 4 kHz, the motor generates just 95 % of its rated torque with increased noise emissions.

MCA asynchronous servo motors

Technical data



Selection tables, Servo Drives 9400 HighLine

Forced ventilated IP23s motors

- ▶ The data applies to a mains connection voltage of 3 x 400 V and an inverter switching frequency of 8 kHz.

					E94A□□	E0174	E0244	E0324	E0474	E0594	E0864	E1044	E1454	E1724	E2024	E2454	E2924	
					I_N	16.5	23.5	32.0	41.0	41.0	73.0	78.0	102.0	120.0	131.0	160.0	191.0	
					$I_{0,max}$	49.5	58.8	76.8	94.0	118.0	172.0	208.0	261.0	310.0	364.0	441.0	526.0	
MCA	M_N	n_N	I_N	P_N	I_{max}	49.5	58.8	76.8	94.0	118.0	172.0	208.0	261.0	310.0	364.0	441.0	526.0	
26T12- ...2F□□	255.0	1200	83.3	32.00	M_0						204.0	219.0	290.0	290.0				
					M_N						204.0	219.0	255.0	255.0	255.0			
					$M_{0,max}$						502.0	609.0	739.0	840.0	896.0			
					M_{max}						502.0	609.0	739.0	840.0	896.0			
					η_{eto}											-	-	-
26T22- ...2F□□	230.0	2235	126.7	53.80	M_0									211.0	242.0	290.0	290.0	
					M_N									211.0	230.0	230.0	230.0	
					$M_{0,max}$									611.0	711.0	843.0	1001.0	
					M_{max}									611.0	711.0	843.0	1001.0	
					η_{eto}													-

- ▶ I... [A], M... [Nm], n... [r/min], P... [kW]
- ▶ If the motors are operated at a lower switching frequency, please contact your Lenze sales office!
- ▶ When operating at 4 kHz, the motor generates just 95 % of its rated torque with increased noise emissions.

MCA asynchronous servo motors

Technical data



MCA asynchronous servo motors

Technical data



Selection tables, Inverter Drives 8400 TopLine

Non-ventilated motors

- The data applies to a mains connection voltage of 3 x 400 V and an inverter switching frequency of 8 kHz.

					E84AVTC	□5514	□7514	□1124	□1524	□2224	□3024	□4024	□5524	□7524	□1134	□1534	□1834				
					I_N	1.8	2.4	3.2	3.9	5.9	7.3	9.5	13.0	16.5	23.5	32.0	39.0				
					$I_{0,max}$	2.7	3.6	4.8	5.9	8.4	11.0	14.3	19.5	26.4	32.9	43.2	60.0				
MCA	M_N	n_N	I_N	P_N	I_{max}	3.6	4.8	6.4	7.8	11.2	14.6	19.0	26.0	33.0	47.0	64.0	78.0				
10I40	2.0	3950	2.4	0.80	M_0	-	2.3	2.3	2.3	2.3											
					M_N	-	1.9	1.9	1.9	1.9											
					$M_{0,max}$	4.2	5.8	8.0	9.8	10.0											
					M_{max}	4.2	5.8	8.0	9.8	10.0											
					η_{eto}	-	-	-	-	-											
13I41	4.0	4050	4.4	1.70	M_0			-	-	4.6	4.6	4.6									
					M_N			-	-	4.0	4.0	4.0									
					$M_{0,max}$			7.6	9.6	14.3	18.9	22.9									
					M_{max}			7.6	9.6	14.3	18.9	22.9									
					η_{eto}			-	-	-	-	-									
14L20	6.7	2000	3.3	1.40	M_0		-	-	8.0	8.0	8.0										
					M_N		-	-	6.7	6.7	6.7										
					$M_{0,max}$		11.6	16.2	20.1	29.4	34.7										
					M_{max}		11.6	16.2	20.1	29.4	34.7										
					η_{eto}		-	-	-	-	-										
14L41	5.4	4100	5.8	2.30	M_0					-	8.0	8.0	8.0								
					M_N					-	5.4	5.4	5.4								
					$M_{0,max}$					14.1	19.0	25.1	31.0								
					M_{max}					14.1	19.0	25.1	31.0								
					η_{eto}					-	-	-	-								
17N23	10.8	2300	5.5	2.60	M_0				-	12.8	12.8	12.8	12.8								
					M_N				-	10.8	10.8	10.8	10.8								
					$M_{0,max}$				17.1	25.3	33.3	43.8	51.1								
					M_{max}				17.1	25.3	33.3	43.8	51.1								
					η_{eto}				-	-	-	-	-								
17N41	9.5	4110	10.2	4.10	M_0						-	-	12.8	12.8	12.8						
					M_N						-	-	9.5	9.5	9.5						
					$M_{0,max}$						16.5	22.3	31.1	39.9	49.5						
					M_{max}						16.5	22.3	31.1	39.9	49.5						
					η_{eto}						-	-	-	-	-						
19S23	16.3	2340	8.2	4.00	M_0						-	22.5	22.5	22.5							
					M_N						-	16.3	16.3	16.3							
					$M_{0,max}$						32.8	43.6	60.9	77.5							
					M_{max}						32.8	43.7	61.0	77.5							
					η_{eto}						-	-	-	-							
19S42	12.0	4150	14.0	5.20	M_0								-	22.5	22.5	22.5					
					M_N								-	12.0	12.0	12.0					
					$M_{0,max}$									28.5	37.0	53.7	64.7				
					M_{max}									28.5	37.0	53.8	64.7				
					η_{eto}									-	-	-	-				
21X25	24.6	2490	13.5	6.40	M_0								-	-	39.0	39.0	39.0				
					M_N								-	-	24.5	24.5	24.5				
					$M_{0,max}$									33.6	46.7	59.3	85.9	97.3			
					M_{max}									33.6	46.7	59.3	85.9	97.6			
					η_{eto}									-	-	-	-				

- $I...$ [A], $M...$ [Nm], $n...$ [r/min], $P...$ [kW]

5.5

MCA asynchronous servo motors

Technical data



Selection tables, Inverter Drives 8400 TopLine

Non-ventilated motors

- The data applies to a mains connection voltage of 3 x 400 V and an inverter switching frequency of 8 kHz.

					E84AVTC	□5514	□7514	□1124	□1524	□2224	□3024	□4024	□5524	□7524	□1134	□1534	□1834	
					I_N	1.8	2.4	3.2	3.9	5.9	7.3	9.5	13.0	16.5	23.5	32.0	39.0	
					$I_{0,max}$	2.7	3.6	4.8	5.9	8.4	11.0	14.3	19.5	26.4	32.9	43.2	60.0	
MCA	M_N	n_N	I_N	P_N	I_{max}	3.6	4.8	6.4	7.8	11.2	14.6	19.0	26.0	33.0	47.0	64.0	78.0	
21X42	17.0	4160	19.8	7.40	M_0									-	39.0	39.0	39.0	
					M_N									-	17.0	17.0	17.0	
					$M_{0,max}$										35.3	52.2	72.1	88.5
					M_{max}										35.3	52.2	72.1	88.5
					η_{eto}													-

- I_N [A], M_N [Nm], n_N [r/min], P_N [kW]

MCA asynchronous servo motors

Technical data



Selection tables, Inverter Drives 8400 TopLine

Forced ventilated IP54 motors

- The data applies to a mains connection voltage of 3 x 400 V and an inverter switching frequency of 8 kHz.

					E84AVTC	□1524	□2224	□3024	□4024	□5524	□7524
					I_N	3.9	5.9	7.3	9.5	13.0	16.5
					$I_{0,max}$	5.9	8.4	11.0	14.3	19.5	26.4
MCA	M_N	n_N	I_N	P_N	I_{max}	7.8	11.2	14.6	19.0	26.0	33.0
13I34	6.3	3410	6.0	2.20	M_0	-	-	7.0	7.0	7.0	-
					M_N	-	-	6.2	6.2	6.2	-
					$M_{0,max}$	-	16.0	21.4	28.2	32.0	-
					M_{max}	-	16.0	21.4	28.2	32.0	-
					η_{eto}	-	-	-	-	-	-
14L16	12.0	1635	4.8	2.10	M_0	-	13.5	13.5	13.5	-	-
					M_N	-	12.3	12.3	12.3	-	-
					$M_{0,max}$	23.4	34.7	45.5	50.8	-	-
					M_{max}	23.4	34.7	45.5	50.8	-	-
					η_{eto}	-	-	-	-	-	-
14L35	10.8	3455	9.1	3.90	M_0	-	-	-	13.5	13.5	13.5
					M_N	-	-	-	10.8	10.8	10.8
					$M_{0,max}$	-	-	21.1	28.4	39.8	51.1
					M_{max}	-	-	21.1	28.4	39.8	51.1
					η_{eto}	-	-	-	-	-	-
17N17	21.5	1680	8.5	3.80	M_0	-	-	-	23.9	23.9	23.9
					M_N	-	-	-	21.6	21.6	21.6
					$M_{0,max}$	-	-	42.1	55.9	77.5	93.3
					M_{max}	-	-	42.2	56.0	77.5	93.3
					η_{eto}	-	-	-	-	-	-
17N35	19.0	3480	15.8	6.90	M_0	-	-	-	-	-	23.9
					M_N	-	-	-	-	-	18.9
					$M_{0,max}$	-	-	-	-	38.0	49.5
					M_{max}	-	-	-	-	38.0	49.5
					η_{eto}	-	-	-	-	-	-
19S17	36.3	1700	13.9	6.40	M_0	-	-	-	-	-	40.0
					M_N	-	-	-	-	-	36.0
					$M_{0,max}$	-	-	-	-	71.6	94.7
					M_{max}	-	-	-	-	71.6	94.7
					η_{eto}	-	-	-	-	-	-
19S35	36.0	3510	28.7	13.20	M_0	-	-	-	-	-	-
					M_N	-	-	-	-	-	-
					$M_{0,max}$	-	-	-	-	-	-
					M_{max}	-	-	-	-	-	-
					η_{eto}	-	-	-	-	-	-
21X17	61.4	1710	22.5	11.00	M_0	-	-	-	-	-	-
					M_N	-	-	-	-	-	-
					$M_{0,max}$	-	-	-	-	-	99.0
					M_{max}	-	-	-	-	-	99.0
					η_{eto}	-	-	-	-	-	-
21X35	55.0	3520	42.5	20.30	M_0	-	-	-	-	-	-
					M_N	-	-	-	-	-	-
					$M_{0,max}$	-	-	-	-	-	-
					M_{max}	-	-	-	-	-	-
					η_{eto}	-	-	-	-	-	-

- $I...$ [A], $M...$ [Nm], $n...$ [r/min], $P...$ [kW]

5.5

MCA asynchronous servo motors

Technical data



Selection tables, Inverter Drives 8400 TopLine

Forced ventilated IP54 motors

- The data applies to a mains connection voltage of 3 x 400 V and an inverter switching frequency of 8 kHz.

□1134	□1534	□1834	□2234	□3034	□3734	□4534	E84AVTC						
23.5	32.0	39.0	47.0	61.0	76.0	89.0	I_N	2.20	6.0	3410	6.3	13134	
32.9	43.2	60.0	70.5	91.5	114.0	133.5	$I_{0,max}$						
47.0	64.0	78.0	94.0	122.0	152.0	178.0	I_{max}						
							M_0						
							M_N						
							$M_{0,max}$	2.10	4.8	1635	12.0	14L16	
							M_{max}						
							n_{eto}						
							M_0						
							M_N						
13.5							$M_{0,max}$	3.90	9.1	3455	10.8	14L35	
10.8							M_{max}						
56.5							n_{eto}						
56.6							M_0						
-							M_N						
							$M_{0,max}$	3.80	8.5	1680	21.5	17N17	
							M_{max}						
							n_{eto}						
							M_0						
							M_N						
23.9	23.9						$M_{0,max}$	6.90	15.8	3480	19.0	17N35	
18.9	18.9						M_{max}						
72.5	97.8						n_{eto}						
72.5	97.8						M_0						
-	-						M_N						
40.0	40.0						$M_{0,max}$	6.40	13.9	1700	36.3	19S17	
36.0	36.0						M_{max}						
138.9	165.2						n_{eto}						
139.0	165.3						M_0						
-	-						M_N						
-	40.0	40.0	40.0	40.0			$M_{0,max}$	13.20	28.7	3510	36.0	19S35	
-	35.9	35.9	35.9	35.9			M_{max}						
55.1	78.8	97.8	112.8	146.2			n_{eto}						
55.1	78.8	97.8	112.9	146.2			M_0						
-	-	-	-	-			M_N						
75.0	75.0	75.0	75.0				$M_{0,max}$	11.00	22.5	1710	61.4	21X17	
61.4	61.4	61.4	61.4				M_{max}						
143.7	198.5	242.2	277.2				n_{eto}						
144.0	198.7	242.3	277.2				M_0						
-	-	-	-				M_N						
			75.0	75.0	75.0	75.0	$M_{0,max}$	20.30	42.5	3520	55.0	21X35	
			55.1	55.1	55.1	55.1	M_{max}						
	97.5	120.6	138.5	177.5	216.7	267.8	n_{eto}						
	97.5	120.6	138.6	178.0	217.5	269.8	M_0						
	-	-	-	-	-	-	M_N						

- $I...$ [A], $M...$ [Nm], $n...$ [r/min], $P...$ [kW]

MCA asynchronous servo motors

Technical data



Selection tables, Inverter Drives 8400 TopLine

Forced ventilated IP54 motors

- The data applies to a mains connection voltage of 3 x 400 V and an inverter switching frequency of 8 kHz.

					E84AVTC	□7524	□1134	□1534	□1834	□2234	□3034	□3734	□4534	
					I _N	16.5	23.5	32.0	39.0	47.0	61.0	76.0	89.0	
					I _{0,max}	26.4	32.9	43.2	60.0	70.5	91.5	114.0	133.5	
MCA	M _N	n _N	I _N	P _N	I _{max}	33.0	47.0	64.0	78.0	94.0	122.0	152.0	178.0	
22P08- ...5F□□	110.0	760	22.1	8.80	M ₀	-	120.0	120.0	120.0	120.0				
					M _N	-	110.6	110.6	110.6	110.6				
					M _{0,max}	157.8	233.4	323.3	396.6	394.3				
					M _{max}	157.8	233.5	323.3	396.6	394.3				
					η _{eto}	-	-	-	-	-				
22P14- ...5F□□	107.0	1425	37.7	16.00	M ₀			-	120.0	120.0	120.0	120.0	120.0	
					M _N				-	107.2	107.2	107.2	107.2	107.2
					M _{0,max}				186.5	232.5	268.8	345.7	422.7	458.8
					M _{max}				186.7	232.7	269.0	346.3	423.7	460.9
					η _{eto}				-	-	-	-	-	-
22P17- ...5F□□	105.0	1670	42.7	18.50	M ₀				-	120.0	120.0	120.0	120.0	
					M _N				-	105.8	105.8	105.8	105.8	
					M _{0,max}				162.7	204.2	236.9	307.8	374.9	461.2
					M _{max}				162.7	204.2	237.1	308.3	377.0	462.4
					η _{eto}				-	-	-	-	-	-
22P29- ...5F□□	100.0	2935	72.1	30.70	M ₀						-	120.0	120.0	
					M _N							-	99.9	99.9
					M _{0,max}							180.5	224.5	270.5
					M _{max}							180.8	226.0	271.4
					η _{eto}							-	-	-

- I... [A], M... [Nm], n... [r/min], P... [kW]
- If the motors are operated at a lower switching frequency, please contact your Lenze sales office!

MCA asynchronous servo motors

Technical data



Selection tables, Inverter Drives 8400 TopLine

Forced ventilated IP23s motors

- The data applies to a mains connection voltage of 3 x 400 V and an inverter switching frequency of 8 kHz.

					E84AVTC	□7524	□1134	□1534	□1834	□2234	□3034	□3734	□4534
					I_N	16.5	23.5	32.0	39.0	47.0	61.0	76.0	89.0
					$I_{0,max}$	26.4	32.9	43.2	60.0	70.5	91.5	114.0	133.5
MCA	M_N	n_N	I_N	P_N	I_{max}	33.0	47.0	64.0	78.0	94.0	122.0	152.0	178.0
20X14-...2F□□	61.0	1420	23.0	9.10	M_0	-	67.0	68.0	68.0	68.0			
					M_N	-	61.2	61.2	61.2	61.2			
					$M_{0,max}$	94.8	139.9	192.6	235.5	250.0			
					M_{max}	94.9	139.9	192.8	235.7	250.0			
					η_{eto}	-	-	-	-	-			
20X29-...2F□□	53.5	2930	42.4	16.40	M_0			-	-	57.0	68.0	68.0	68.0
					M_N			-	-	53.4	53.4	53.4	53.4
					$M_{0,max}$			96.8	121.2	140.3	182.5	222.1	250.0
					M_{max}			96.8	121.2	140.4	182.6	223.0	250.0
					η_{eto}			-	-	-	-	-	-
22P08-...2F□□	120.0	760	23.5	9.60	M_0	-	135.0	135.0	135.0	135.0			
					M_N	-	120.6	120.6	120.6	120.6			
					$M_{0,max}$	157.8	234.2	325.4	401.4	400.9			
					M_{max}	157.8	234.8	325.8	401.4	400.9			
					η_{eto}	-	-	-	-	-			
22P14-...2F□□	115.0	1425	40.0	17.20	M_0			-	-	135.0	135.0	135.0	135.0
					M_N			-	-	115.3	115.3	115.3	115.3
					$M_{0,max}$			188.4	235.1	270.8	350.2	425.8	493.6
					M_{max}			188.7	235.1	271.0	350.3	428.1	496.1
					η_{eto}			-	-	-	-	-	-
22P17-...2F□□	112.0	1670	44.5	19.60	M_0			-	-	135.0	135.0	135.0	135.0
					M_N			-	-	112.1	112.1	112.1	112.1
					$M_{0,max}$			163.1	204.6	237.9	309.7	376.9	463.1
					M_{max}			163.1	204.6	238.2	310.6	379.0	465.2
					η_{eto}			-	-	-	-	-	-
22P29-...2F□□	110.0	2935	77.8	33.80	M_0					-	-	-	135.0
					M_N					-	-	-	110.0
					$M_{0,max}$					180.0	224.4	268.2	
					M_{max}					180.7	225.0	269.4	
					η_{eto}					-	-	-	

- $I...$ [A], $M...$ [Nm], $n...$ [r/min], $P...$ [kW]
- If the motors are operated at a lower switching frequency, please contact your Lenze sales office!

MCA asynchronous servo motors

Technical data



Selection tables, Servo Drives ECS

Non-ventilated motors

- The data applies to a mains connection voltage of 3 x 400 V and an inverter switching frequency of 4 kHz.

					ECS□□	008C□B	016C□B	032C□B	048C□B	064C□B
					I_N	4.0	8.0	12.7	17.0	20.0
					$I_{0,max}$	4.6	9.1	18.1	27.2	36.3
MCA	M_N	n_N	I_N	P_N	I_{max}	8.0	16.0	32.0	48.0	64.0
10I40	2.0	3950	2.4	0.80	M_0	2.3				
					M_N	2.0				
					$M_{0,max}$	5.6				
					M_{max}	8.1				
					η_{eto}	-				
13I41	4.0	4050	4.4	1.70	M_0	3.0	4.6			
					M_N	3.0	4.0			
					$M_{0,max}$	4.3	11.0			
					M_{max}	9.4	18.2			
					η_{eto}	-	-			
14L20	6.7	2000	3.3	1.40	M_0	8.0	8.0			
					M_N	6.7	6.7			
					$M_{0,max}$	10.7	25.3			
					M_{max}	21.6	42.8			
					η_{eto}	-	-			
14L41	5.4	4100	5.8	2.30	M_0		8.0	8.0		
					M_N		5.4	5.4		
					$M_{0,max}$		11.0	24.0		
					M_{max}		20.7	29.1		
					η_{eto}		-	-		
17N23	10.8	2300	5.5	2.60	M_0		12.8	12.8		
					M_N		10.8	10.8		
					$M_{0,max}$		20.5	43.5		
					M_{max}		40.2	63.7		
					η_{eto}		-	-		
17N41	9.5	4110	10.2	4.10	M_0		6.1	12.8	12.8	
					M_N		6.1	9.5	9.5	
					$M_{0,max}$		7.8	21.5	33.5	
					M_{max}		17.4	29.6	57.7	
					η_{eto}		-	-	-	
19S23	16.3	2340	8.2	4.00	M_0		15.1	22.5		
					M_N		15.1	16.3		
					$M_{0,max}$		18.7	43.5		
					M_{max}		38.5	67.9		
					η_{eto}		-	-		
19S42	12.0	4150	14.0	5.20	M_0			9.8	16.7	
					M_N			9.8	12.0	
					$M_{0,max}$			18.4	31.9	
					M_{max}			29.9	58.2	
					η_{eto}			-	-	
21X25	24.6	2490	13.5	6.40	M_0			21.0	39.0	
					M_N			21.0	24.6	
					$M_{0,max}$			41.0	64.5	
					M_{max}			64.4	120.5	
					η_{eto}			-	-	

- $I...$ [A], $M...$ [Nm], $n...$ [r/min], $P...$ [kW]

MCA asynchronous servo motors

Technical data



Selection tables, Servo Drives ECS

Non-ventilated motors

- The data applies to a mains connection voltage of 3 x 400 V and an inverter switching frequency of 4 kHz.

					ECS□□	008C□B	016C□B	032C□B	048C□B	064C□B
					I_N	4.0	8.0	12.7	17.0	20.0
					$I_{0,max}$	4.6	9.1	18.1	27.2	36.3
MCA	M_N	n_N	I_N	P_N	I_{max}	8.0	16.0	32.0	48.0	64.0
21X42	17.0	4160	19.8	7.40	M_0				13.0	17.0
					M_N				13.0	17.0
					$M_{0,max}$				30.0	45.0
					M_{max}				59.4	83.0
					η_{eto}				-	-

- I_N [A], M_N [Nm], n_N [r/min], P_N [kW]

MCA asynchronous servo motors

Technical data



Selection tables, Servo Drives ECS

Forced ventilated IP54 motors

- The data applies to a mains connection voltage of 3 x 400 V and an inverter switching frequency of 4 kHz.

					ECS□□	008C□B	016C□B	032C□B	048C□B	064C□B
					I_N	4.0	8.0	12.7	17.0	20.0
					$I_{0,max}$	4.6	9.1	18.1	27.2	36.3
MCA	M_N	n_N	I_N	P_N	I_{max}	8.0	16.0	32.0	48.0	64.0
13I34	6.3	3410	6.0	2.20	M_0		7.0			
					M_N		6.3			
					$M_{0,max}$		10.7			
					M_{max}		20.8			
					η_{eto}		-			
14L16	12.0	1635	4.8	2.10	M_0	8.9	13.5			
					M_N	8.9	12.0			
					$M_{0,max}$	11.5	25.4			
					M_{max}	21.6	46.7			
					η_{eto}	-	-			
14L35	10.8	3455	9.1	3.90	M_0		8.3	13.5	13.5	
					M_N		8.3	10.8	10.8	
					$M_{0,max}$		11.0	27.0	41.0	
					M_{max}		22.2	42.0	60.0	
					η_{eto}		-	-	-	
17N17	21.5	1680	8.5	3.80	M_0		19.5	23.9		
					M_N		19.5	21.5		
					$M_{0,max}$		23.0	53.0		
					M_{max}		44.8	80.0		
					η_{eto}		-	-		
17N35	19.0	3480	15.8	6.90	M_0			12.7	23.0	
					M_N			12.7	19.0	
					$M_{0,max}$			23.0	37.5	
					M_{max}			37.7	64.4	
					η_{eto}			-	-	
19S17	36.3	1700	13.9	6.40	M_0			28.3	40.0	40.0
					M_N			28.3	36.3	36.3
					$M_{0,max}$			46.5	72.0	98.0
					M_{max}			75.4	130.8	158.9
					η_{eto}			-	-	-
21X17	61.4	1710	22.5	11.00	M_0					52.5
					M_N					52.5
					$M_{0,max}$					107.0
					M_{max}					190.0
					η_{eto}					-

- I... [A], M... [Nm], n... [r/min], P... [kW]

MCA asynchronous servo motors

Technical data



Selection tables, Servo Inverter 9300

Non-ventilated motors

- The data applies to a mains connection voltage of 3 x 400 V and an inverter switching frequency of 8 kHz.

					EVS	9322-E□	9323-E□	9324-E□	9325-E□	9326-E□	9327-E□	9328-E□	9329-E□
					I_N	2.5	3.9	7.0	13.0	23.5	32.0	47.0	59.0
					$I_{0,max}$	3.8	5.9	10.5	19.5	23.5	32.0	47.0	52.0
MCA	M_N	n_N	I_N	P_N	I_{max}	3.8	5.9	10.5	19.5	35.3	48.0	70.5	88.5
10I40	2.0	3950	2.4	0.80	M_0	2.2	2.3						
					M_N	2.0	2.0						
					$M_{0,max}$	4.4	7.3						
					M_{max}	4.4	7.3						
					η_{eto}	-	-						
13I41	4.0	4050	4.4	1.70	M_0			4.6	4.6				
					M_N			4.0	4.0				
					$M_{0,max}$			12.6	19.5				
					M_{max}			12.6	19.5				
					η_{eto}			-	-				
14L20	6.7	2000	3.3	1.40	M_0		8.0	8.0					
					M_N		6.7	6.7					
					$M_{0,max}$		15.1	29.3					
					M_{max}		15.1	29.3					
					η_{eto}		-	-					
14L41	5.4	4100	5.8	2.30	M_0			7.0	8.0				
					M_N			5.4	5.4				
					$M_{0,max}$			13.2	26.0				
					M_{max}			13.2	26.0				
					η_{eto}			-	-				
17N23	10.8	2300	5.5	2.60	M_0			12.8	12.8				
					M_N			10.8	10.8				
					$M_{0,max}$			24.4	46.2				
					M_{max}			24.4	46.2				
					η_{eto}			-	-				
17N41	9.5	4110	10.2	4.10	M_0			12.8	12.8	12.8			
					M_N			9.5	9.5	9.5			
					$M_{0,max}$			23.4	37.0	54.0			
					M_{max}			23.4	43.7	59.4			
					η_{eto}			-	-	-			
19S23	16.3	2340	8.2	4.00	M_0			22.5	22.5				
					M_N			16.3	16.3				
					$M_{0,max}$			47.2	78.0				
					M_{max}			47.2	88.2				
					η_{eto}			-	-				
19S42	12.0	4150	14.0	5.20	M_0			10.0	22.5	22.5			
					M_N			10.0	12.0	12.0			
					$M_{0,max}$			20.7	33.5	51.0			
					M_{max}			20.7	43.3	60.7			
					η_{eto}			-	-	-			
21X25	24.6	2490	13.5	6.40	M_0			23.7	39.0	39.0			
					M_N			23.7	24.6	24.6			
					$M_{0,max}$			46.2	66.0	84.0			
					M_{max}			46.2	78.0	92.4			
					η_{eto}			-	-	-			

- $I...$ [A], $M...$ [Nm], $n...$ [r/min], $P...$ [kW]

MCA asynchronous servo motors

Technical data



Selection tables, Servo Inverter 9300

Non-ventilated motors

- The data applies to a mains connection voltage of 3 x 400 V and an inverter switching frequency of 8 kHz.

					EVS	9322-E□	9323-E□	9324-E□	9325-E□	9326-E□	9327-E□	9328-E□	9329-E□
					I_N	2.5	3.9	7.0	13.0	23.5	32.0	47.0	59.0
					$I_{0,max}$	3.8	5.9	10.5	19.5	23.5	32.0	47.0	52.0
MCA	M_N	n_N	I_N	P_N	I_{max}	3.8	5.9	10.5	19.5	35.3	48.0	70.5	88.5
21X42	17.0	4160	19.8	7.40	M_0					24.0	39.0	39.0	39.0
					M_N					17.0	17.0	17.0	17.0
					$M_{0,max}$					24.0	47.0	84.0	94.0
					M_{max}					43.9	63.3	96.8	123.0
					n_{eto}					-	-	-	-

- I_N [A], M_N [Nm], n_N [r/min], P_N [kW]

MCA asynchronous servo motors

Technical data



Selection tables, Servo Inverter 9300

Forced ventilated IP54 motors

- The data applies to a mains connection voltage of 3 x 400 V and an inverter switching frequency of 8 kHz.

					EVS	9324-E□	9325-E□	9326-E□	9327-E□	9328-E□	9329-E□	9330-E□	9331-E□
					I _N	7.0	13.0	23.5	32.0	47.0	59.0	89.0	110.0
					I _{0,max}	10.5	19.5	23.5	32.0	47.0	52.0	80.0	110.0
MCA	M _N	n _N	I _N	P _N	I _{max}	10.5	19.5	35.3	48.0	70.5	88.5	133.5	165.0
13I34	6.3	3410	6.0	2.20	M ₀	7.0	7.0						
					M _N	6.3	6.3						
					M _{0,max}	13.0	25.0						
					M _{max}	13.0	25.0						
					η _{eto}	-	-						
14L16	12.0	1635	4.8	2.10	M ₀	13.5							
					M _N	12.0							
					M _{0,max}	29.6							
					M _{max}	29.6							
					η _{eto}	-							
14L35	10.8	3455	9.1	3.90	M ₀		13.5	13.5					
					M _N		10.8	10.8					
					M _{0,max}		29.3	47.0					
					M _{max}		29.3	53.8					
					η _{eto}		-	-					
17N17	21.5	1680	8.5	3.80	M ₀		23.9						
					M _N		21.5						
					M _{0,max}		57.2						
					M _{max}		57.2						
					η _{eto}		-						
17N35	19.0	3480	15.8	6.90	M ₀			23.9	23.9	23.9			
					M _N			19.0	19.0	19.0			
					M _{0,max}			27.5	57.0	89.0			
					M _{max}			50.7	69.2	100.2			
					η _{eto}			-	-	-			
19S17	36.3	1700	13.9	6.40	M ₀		34.0	40.0	40.0				
					M _N		34.0	36.3	36.3				
					M _{0,max}		50.1	76.0	112.0				
					M _{max}		50.1	95.9	130.8				
					η _{eto}		-	-	-				
19S35	36.0	3510	28.7	13.20	M ₀			21.0	39.0	40.0	40.0	40.0	
					M _N			21.0	36.0	36.0	36.0	36.0	
					M _{0,max}			21.0	39.0	73.0	80.0	161.5	
					M _{max}			45.7	67.6	104.3	132.9	180.0	
					η _{eto}			-	-	-	-	-	
21X17	61.4	1710	22.5	11.00	M ₀			65.5	75.0	75.0	75.0		
					M _N			61.4	61.4	61.4	61.4		
					M _{0,max}			65.5	102.0	178.0	200.0		
					M _{max}			104.1	143.3	210.7	257.3		
					η _{eto}			-	-	-	-		
21X35	55.0	3520	42.5	20.30	M ₀					68.0	75.0	75.0	75.0
					M _N					55.0	55.0	55.0	55.0
					M _{0,max}					68.0	88.0	156.0	219.0
					M _{max}					107.7	135.9	205.0	250.1
					η _{eto}					-	-	-	-

- I... [A], M... [Nm], n... [r/min], P... [kW]

MCA asynchronous servo motors

Technical data



Selection tables, Servo Inverter 9300

Forced ventilated IP54 motors

- The data applies to a mains connection voltage of 3 x 400 V and an inverter switching frequency of 8 kHz.

					EVS	9326-E□	9327-E□	9328-E□	9329-E□	9330-E□	9331-E□	9332-E□
					I_N	23.5	32.0	47.0	59.0	89.0	110.0	145.0
					$I_{0,max}$	23.5	32.0	47.0	52.0	80.0	110.0	126.0
MCA	M_N	n_N	I_N	P_N	I_{max}	35.3	48.0	70.5	88.5	133.5	165.0	217.5
22P08-...5F□□	110.0	760	22.1	8.80	M_0	115.0	120.0	120.0	120.0			
					M_N	108.0	110.0	110.0	110.0			
					$M_{0,max}$	115.0	166.0	242.0	267.0			
					M_{max}	185.0	247.0	338.8	345.8			
					η_{eto}	-	-	-	-			
22P14-...5F□□	107.0	1425	37.7	16.00	M_0			120.0	120.0	120.0		
					M_N			107.0	107.0	107.0		
					$M_{0,max}$			146.0	160.0	264.0		
					M_{max}			230.1	292.9	341.8		
					η_{eto}			-	-	-		
22P17-...5F□□	105.0	1670	42.7	18.50	M_0			120.0	120.0	120.0	120.0	
					M_N			106.0	106.0	106.0	106.0	
					$M_{0,max}$			124.0	140.0	240.0	335.0	
					M_{max}			180.5	227.7	342.1	378.3	
					η_{eto}			-	-	-	-	
22P29-...5F□□	100.0	2935	72.1	30.70	M_0					118.0	120.0	120.0
					M_N					100.0	100.0	100.0
					$M_{0,max}$					122.0	171.0	200.0
					M_{max}					215.6	273.1	355.1
					η_{eto}					-	-	-
26T05-...5F□□	216.0	550	34.9	12.40	M_0		191.0	220.0	220.0	220.0		
					M_N		191.0	216.0	216.0	216.0		
					$M_{0,max}$		191.0	303.0	333.0	615.0		
					M_{max}		313.0	482.0	612.0	751.0		
					η_{eto}		-	-	-	-		
26T10-...5F□□	210.0	1030	61.5	22.70	M_0				159.0	220.0	220.0	
					M_N				197.0	210.0	210.0	
					$M_{0,max}$				159.0	300.0	440.0	
					M_{max}				343.0	552.0	671.0	
					η_{eto}				-	-	-	
26T12-...5F□□	207.0	1200	75.1	26.00	M_0					207.0	220.0	220.0
					M_N					255.0	207.0	207.0
					$M_{0,max}$					258.0	327.0	397.0
					M_{max}					424.0	512.0	663.0
					η_{eto}					-	-	-
26T22-...5F□□	195.0	2235	112.9	45.60	M_0						177.0	220.0
					M_N						177.0	195.0
					$M_{0,max}$						203.0	220.0
					M_{max}						315.0	432.0
					η_{eto}						-	-

- $I...$ [A], $M...$ [Nm], $n...$ [r/min], $P...$ [kW]
- If the motors are operated at a lower switching frequency, please contact your Lenze sales office!

5.5

MCA asynchronous servo motors

Technical data



Selection tables, Servo Inverter 9300

Forced ventilated IP23s motors

- The data applies to a mains connection voltage of 3 x 400 V and an inverter switching frequency of 8 kHz.

					EVS	9326-E□	9327-E□	9328-E□	9329-E□	9330-E□	9331-E□	9332-E□
					I_N	23.5	32.0	47.0	59.0	89.0	110.0	145.0
					$I_{0,max}$	23.5	32.0	47.0	52.0	80.0	110.0	126.0
MCA	M_N	n_N	I_N	P_N	I_{max}	35.3	48.0	70.5	88.5	133.5	165.0	217.5
20X14-...2F□□	61.0	1420	23.0	9.10	M_0	61.0	68.0	68.0				
					M_N	61.0	61.0	61.0				
					$M_{0,max}$	61.0	93.0	153.0				
					M_{max}	109.3	156.7	232.1				
					η_{eto}	-	-	-				
20X29-...2F□□	53.5	2930	42.4	16.40	M_0		28.0	66.3	68.0	68.0		
					M_N		28.0	53.5	53.5	53.5		
					$M_{0,max}$		28.0	66.3	72.0	129.0		
					M_{max}		68.5	112.5	146.4	226.7		
					η_{eto}		-	-	-	-		
22P08-...2F□□	120.0	760	23.5	9.60	M_0	115.0	135.0	135.0	135.0			
					M_N	115.0	120.0	120.0	120.0			
					$M_{0,max}$	115.0	166.0	242.0	267.0			
					M_{max}	185.0	247.0	338.8	345.8			
					η_{eto}	-	-	-	-			
22P14-...2F□□	115.0	1425	40.0	17.20	M_0			135.0	135.0	135.0		
					M_N			115.0	115.0	115.0		
					$M_{0,max}$			146.0	160.0	264.0		
					M_{max}			230.1	292.9	341.8		
					η_{eto}			-	-	-		
22P17-...2F□□	112.0	1670	44.5	19.60	M_0			124.0	134.0	135.0	135.0	
					M_N			112.0	112.0	112.0	112.0	
					$M_{0,max}$			124.0	140.0	240.0	335.0	
					M_{max}			180.5	227.7	342.1	378.3	
					η_{eto}			-	-	-	-	
22P29-...2F□□	110.0	2935	77.8	33.80	M_0					118.0	135.0	135.0
					M_N					110.0	110.0	110.0
					$M_{0,max}$					122.0	171.0	200.0
					M_{max}					215.6	273.1	355.1
					η_{eto}					-	-	-
26T05-...2F□□	280.0	550	42.4	16.10	M_0		191.0	290.0	290.0	290.0		
					M_N		191.0	280.0	280.0	280.0		
					$M_{0,max}$		191.0	303.0	333.0	615.0		
					M_{max}		313.0	482.0	612.0	751.0		
					η_{eto}		-	-	-	-		
26T10-...2F□□	260.0	1030	69.6	28.00	M_0				159.0	290.0	290.0	
					M_N				197.0	260.0	260.0	
					$M_{0,max}$				159.0	300.0	440.0	
					M_{max}				343.0	552.0	671.0	
					η_{eto}				-	-	-	

- $I...$ [A], $M...$ [Nm], $n...$ [r/min], $P...$ [kW]
- If the motors are operated at a lower switching frequency, please contact your Lenze sales office!

MCA asynchronous servo motors

Technical data



Selection tables, Servo Inverter 9300

Forced ventilated IP23s motors

- The data applies to a mains connection voltage of 3 x 400 V and an inverter switching frequency of 8 kHz.

					EVS	9326-E□	9327-E□	9328-E□	9329-E□	9330-E□	9331-E□	9332-E□
					I_N	23.5	32.0	47.0	59.0	89.0	110.0	145.0
					$I_{0,max}$	23.5	32.0	47.0	52.0	80.0	110.0	126.0
MCA	M_N	n_N	I_N	P_N	I_{max}	35.3	48.0	70.5	88.5	133.5	165.0	217.5
26T12- ...2F□□	255.0	1200	83.3	32.00	M_0					232.0	290.0	290.0
					M_N					255.0	255.0	255.0
					$M_{0,max}$					258.0	327.0	397.0
					M_{max}					424.0	512.0	663.0
					η_{eto}					-	-	-
26T22- ...2F□□	230.0	2235	126.7	53.80	M_0						177.0	222.0
					M_N						177.0	230.0
					$M_{0,max}$						203.0	220.0
					M_{max}						315.0	432.0
					η_{eto}						-	-

- $I...$ [A], $M...$ [Nm], $n...$ [r/min], $P...$ [kW]
- If the motors are operated at a lower switching frequency, please contact your Lenze sales office!

MCA asynchronous servo motors

Technical data



Torque characteristics

► The data applies to a mains connection voltage of 3 x 400 V.

MCA10I40 (non-ventilated)

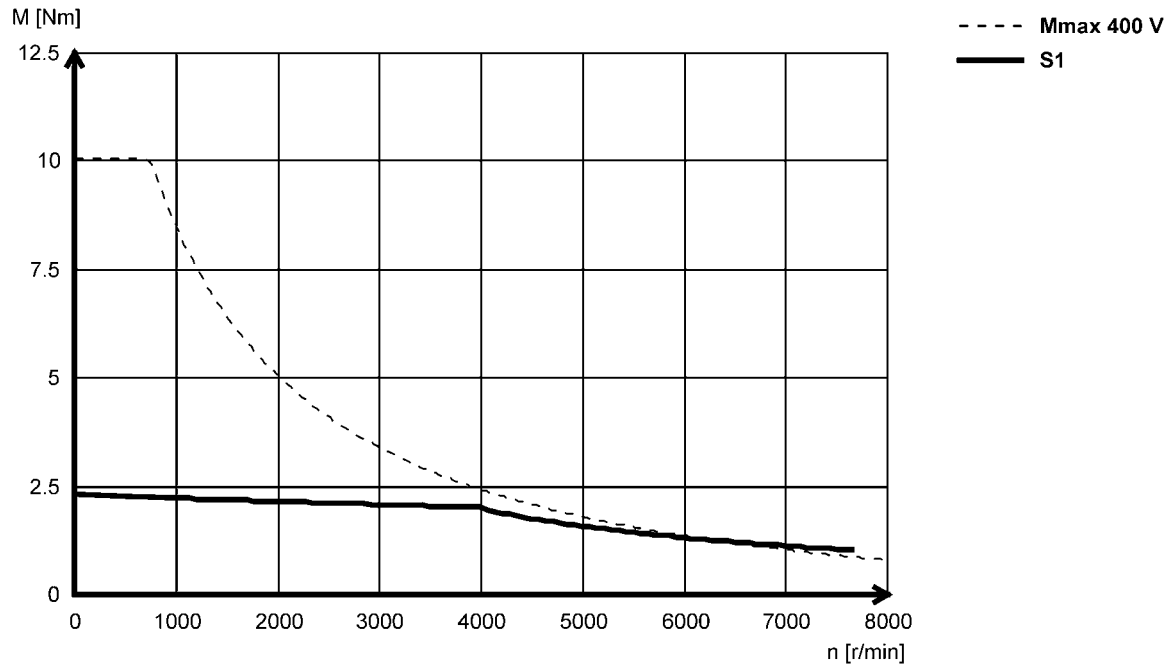

MCA asynchronous servo motors

Technical data



Torque characteristics

► The data applies to a mains connection voltage of 3 x 400 V.

MCA13134 (forced ventilated)

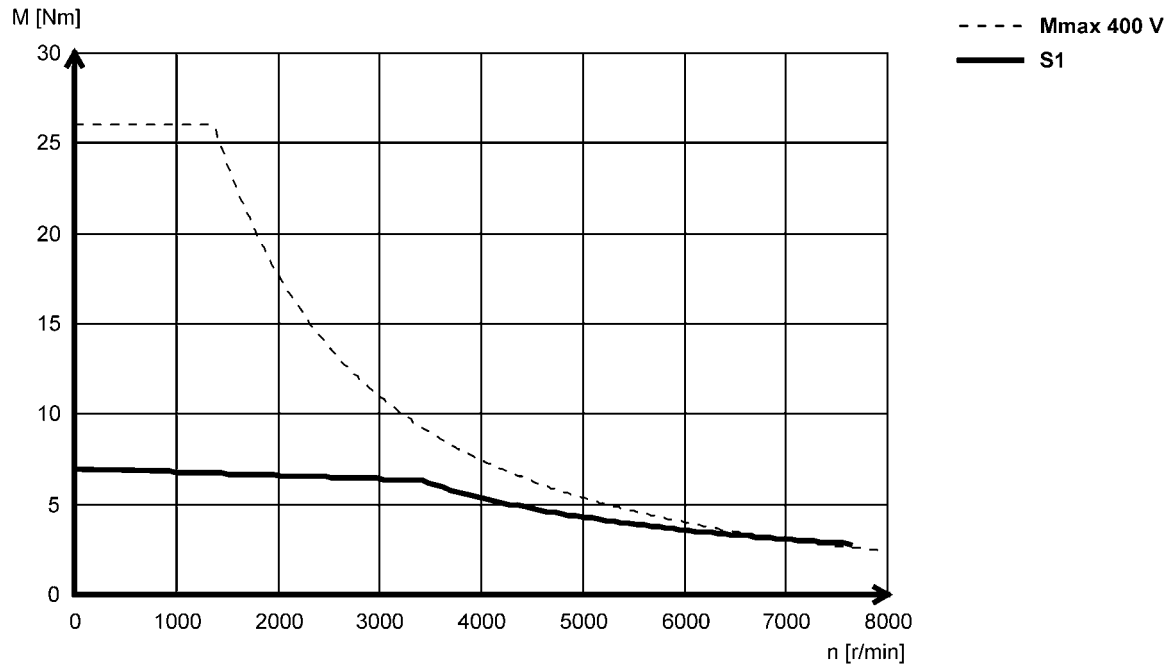

MCA13141 (non-ventilated)

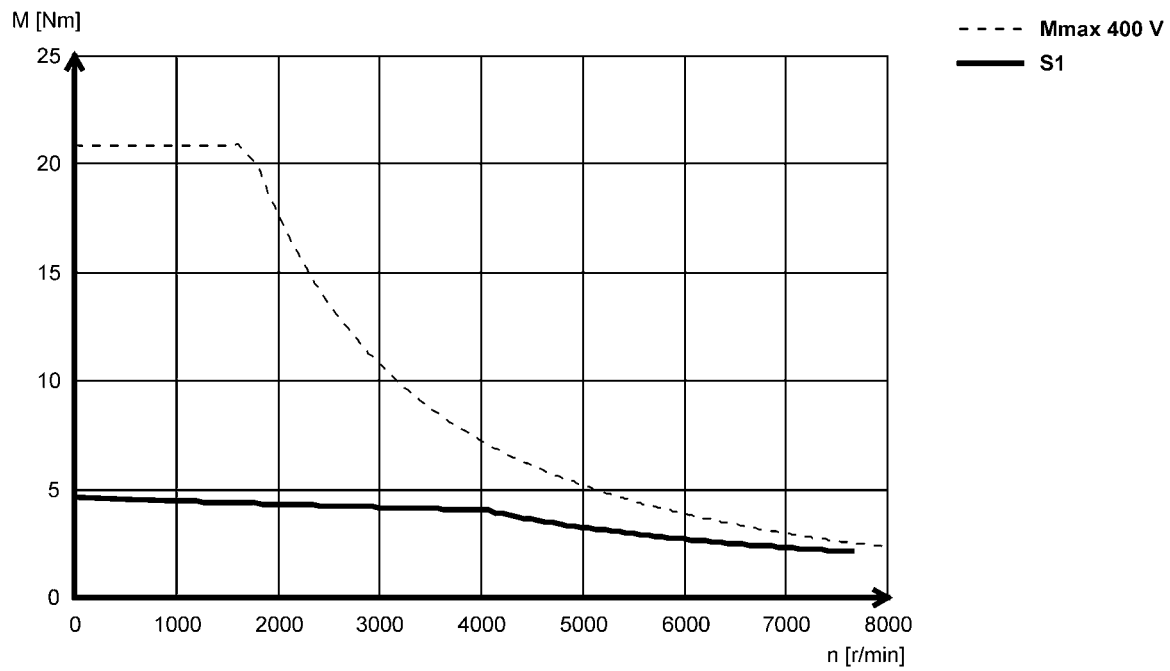

MCA asynchronous servo motors

Technical data



Torque characteristics

► The data applies to a mains connection voltage of 3 x 400 V.

MCA14L16 (forced ventilated)

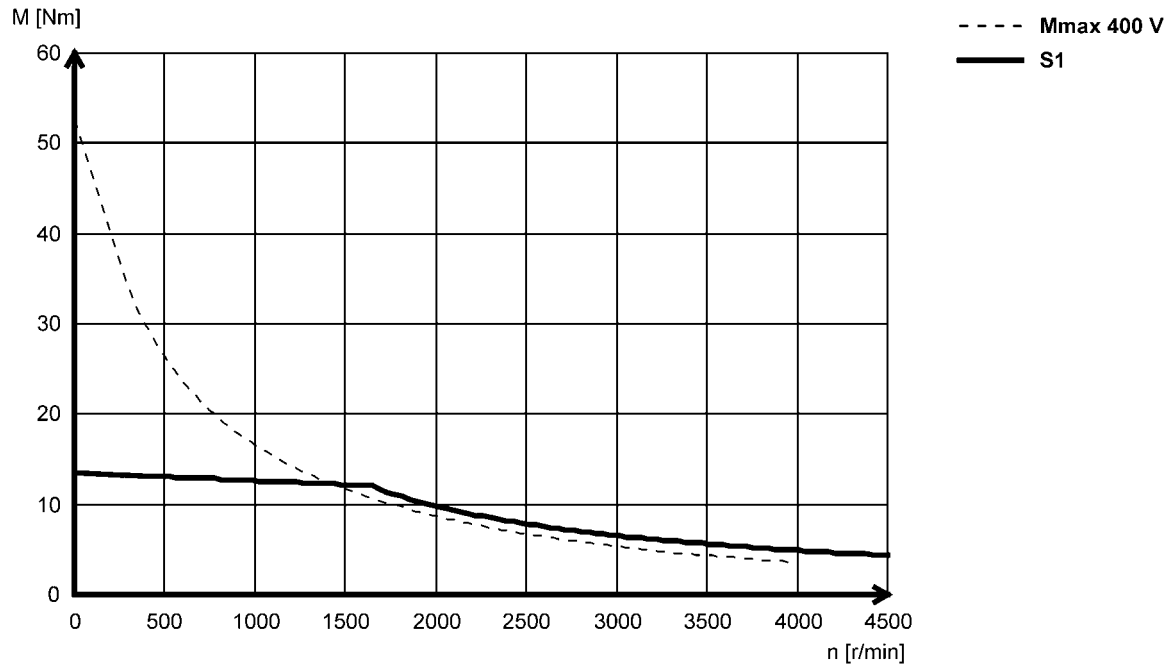

MCA14L20 (non-ventilated)

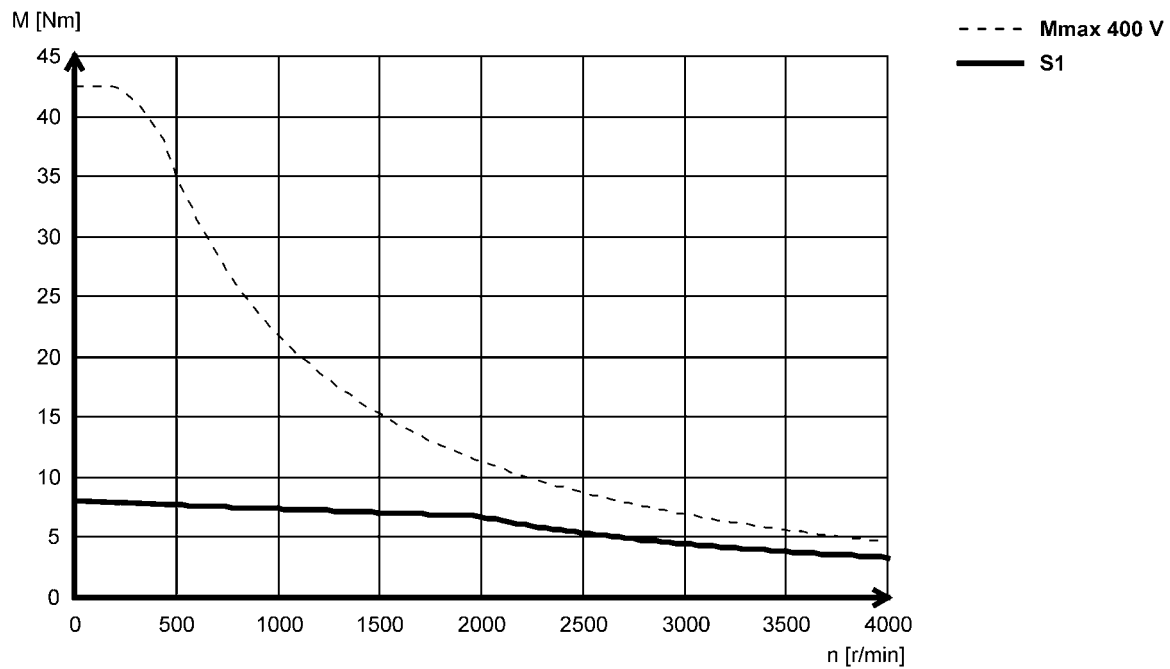

5.5

MCA asynchronous servo motors

Technical data



Torque characteristics

► The data applies to a mains connection voltage of 3 x 400 V.

MCA14L35 (forced ventilated)

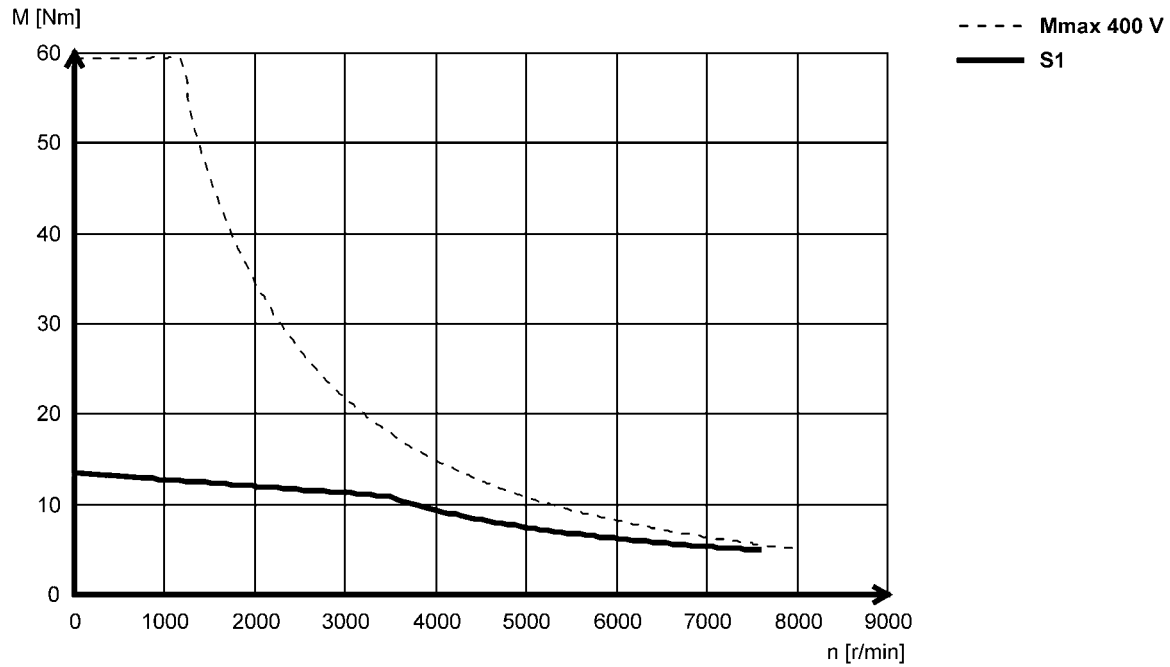

MCA14L41 (non-ventilated)

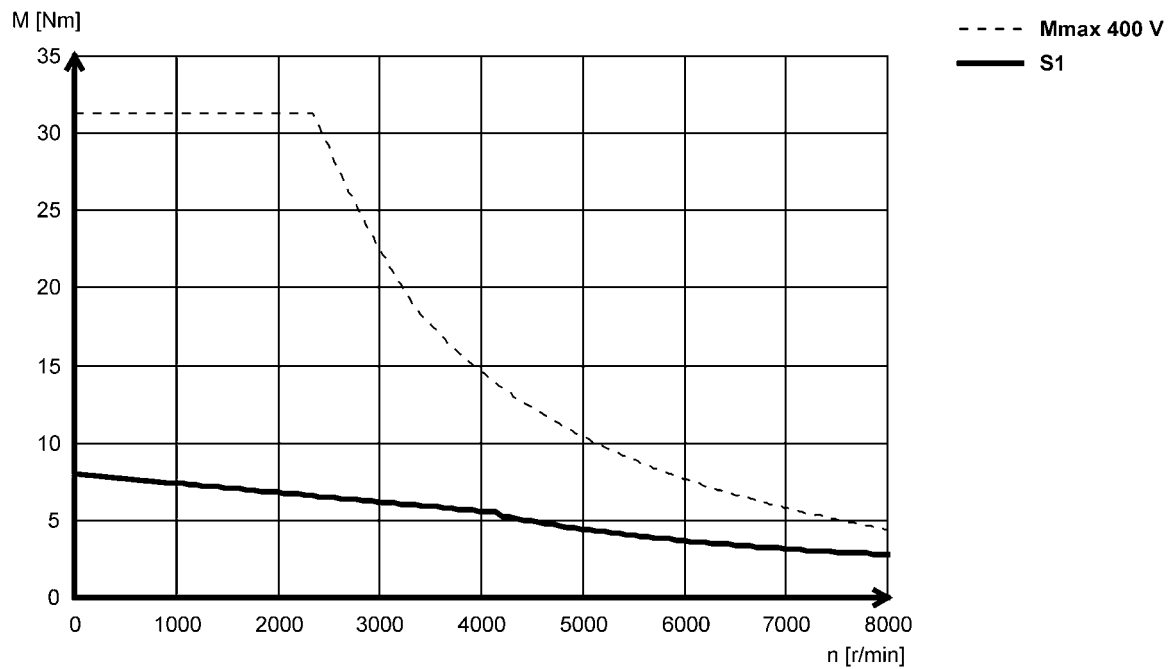

5.5

MCA asynchronous servo motors

Technical data



Torque characteristics

► The data applies to a mains connection voltage of 3 x 400 V.

MCA17N17 (forced ventilated)

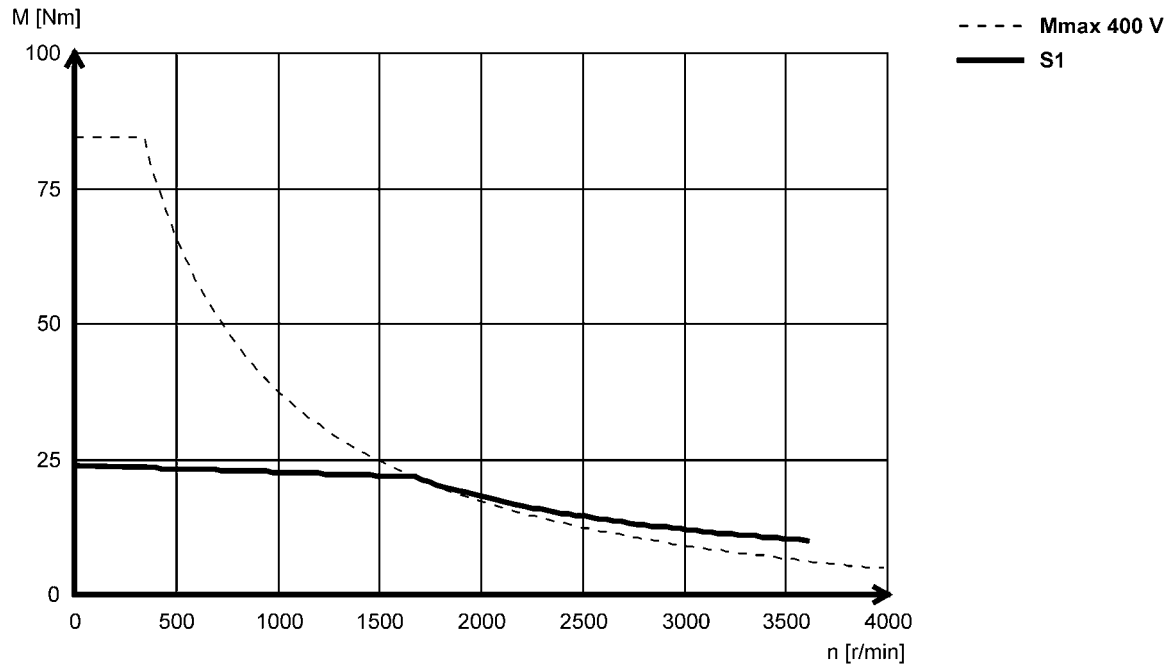

MCA17N23 (non-ventilated)

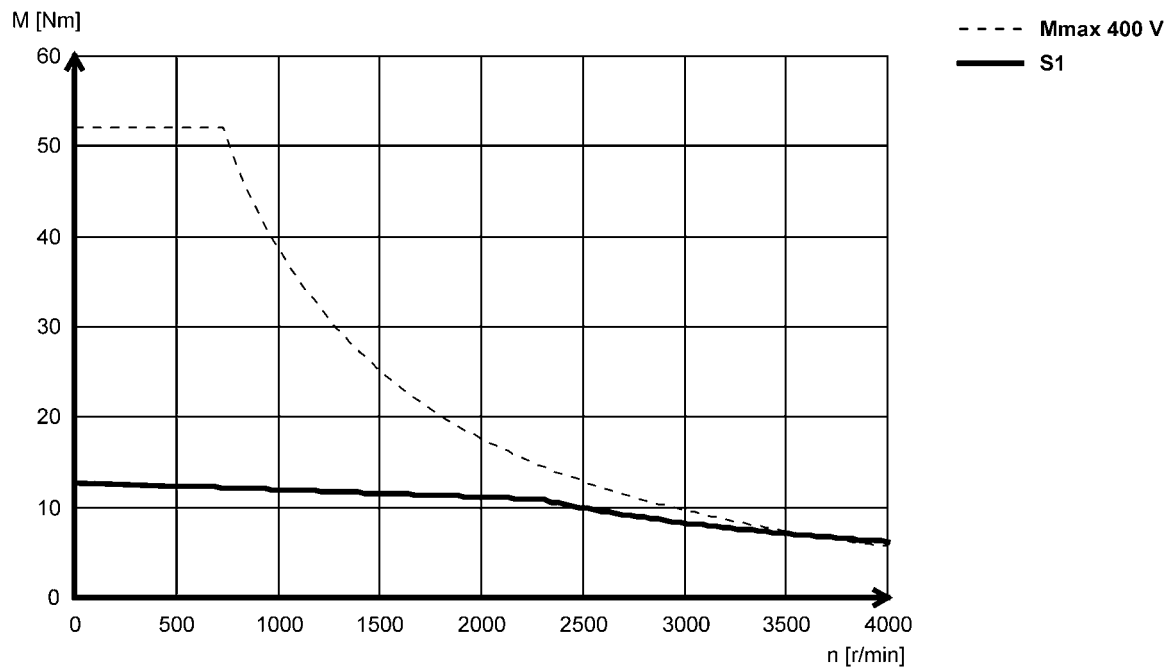

5.5

MCA asynchronous servo motors

Technical data



Torque characteristics

► The data applies to a mains connection voltage of 3 x 400 V.

MCA17N35 (forced ventilated)

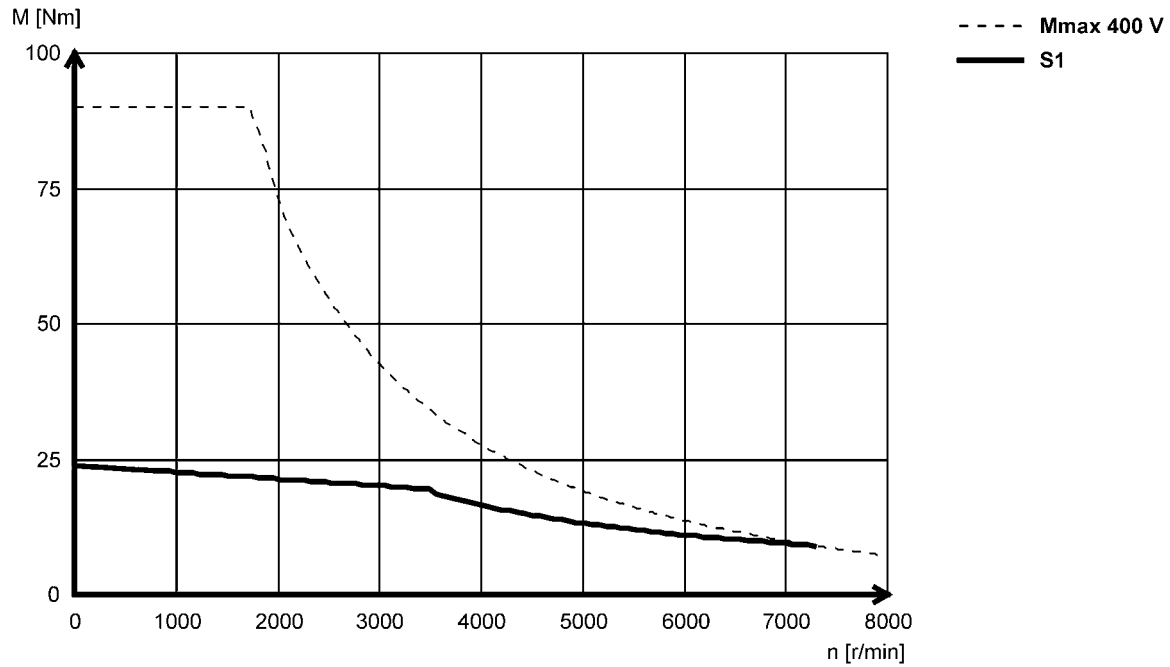

MCA17N41 (non-ventilated)

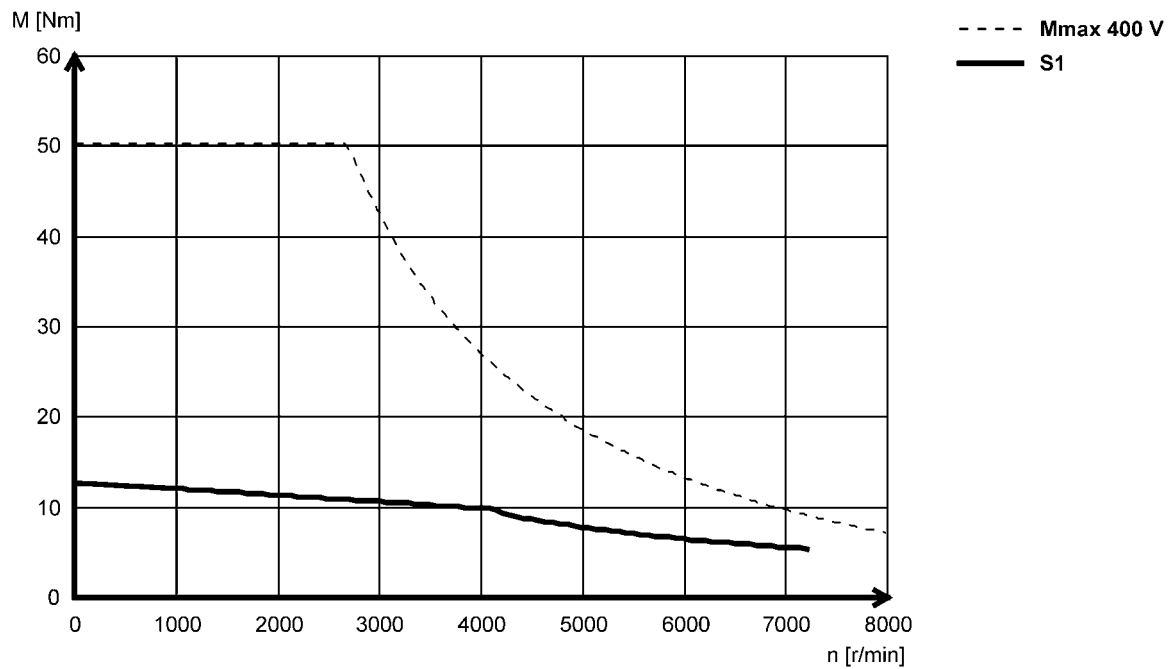

5.5

MCA asynchronous servo motors

Technical data



Torque characteristics

► The data applies to a mains connection voltage of 3 x 400 V.

MCA19S17 (forced ventilated)

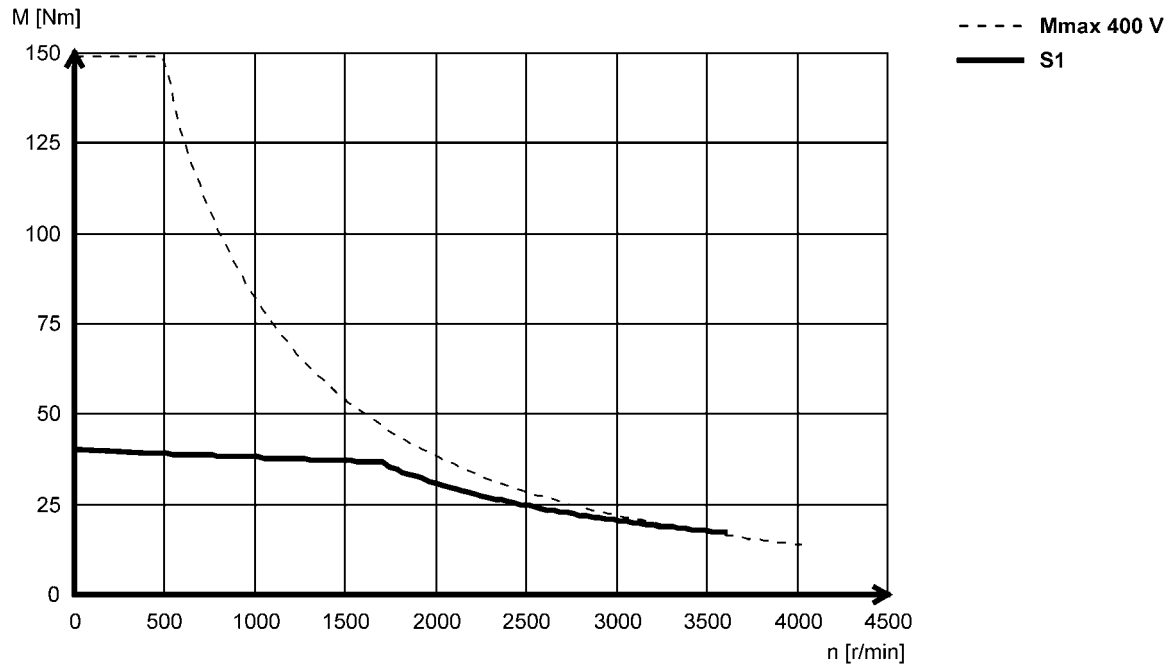

MCA19S23 (non-ventilated)

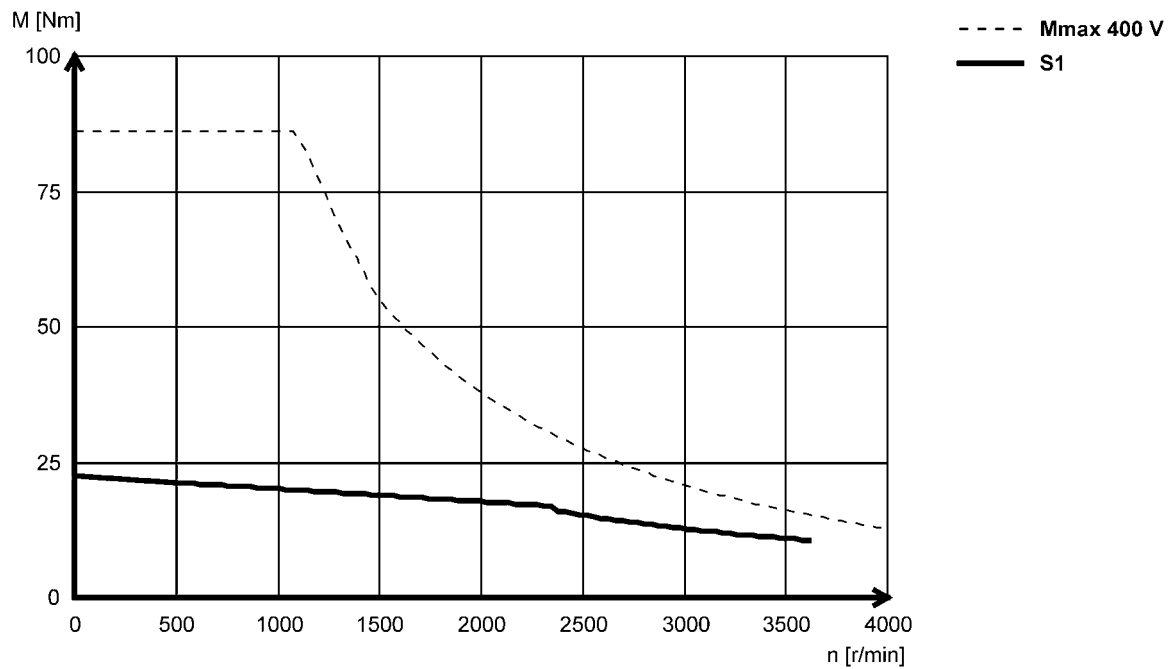

5.5

MCA asynchronous servo motors

Technical data



Torque characteristics

► The data applies to a mains connection voltage of 3 x 400 V.

MCA19S35 (forced ventilated)

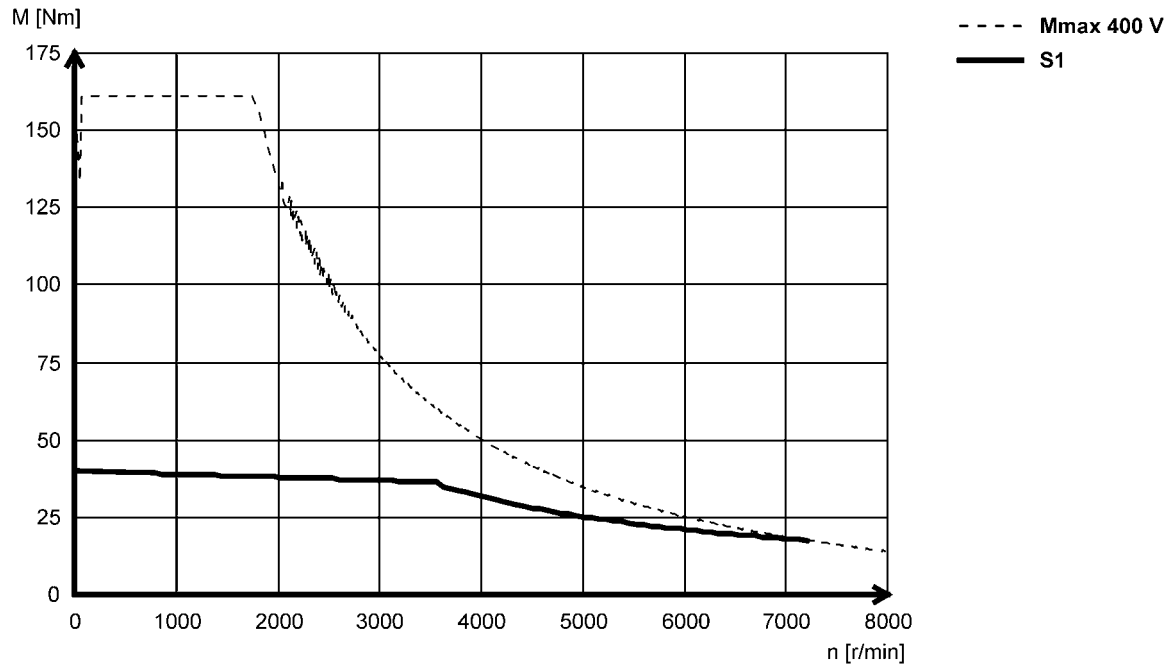

MCA19S42 (non-ventilated)

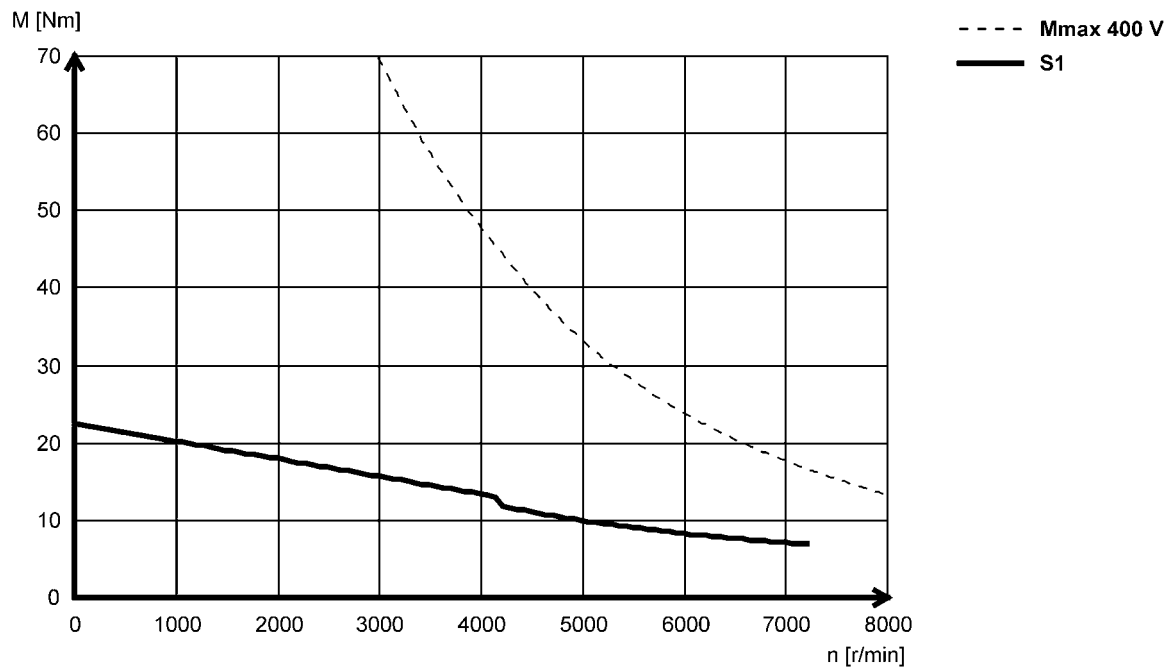

5.5

MCA asynchronous servo motors

Technical data



Torque characteristics

► The data applies to a mains connection voltage of 3 x 400 V.

MCA20X14...2F□□ (forced ventilated)

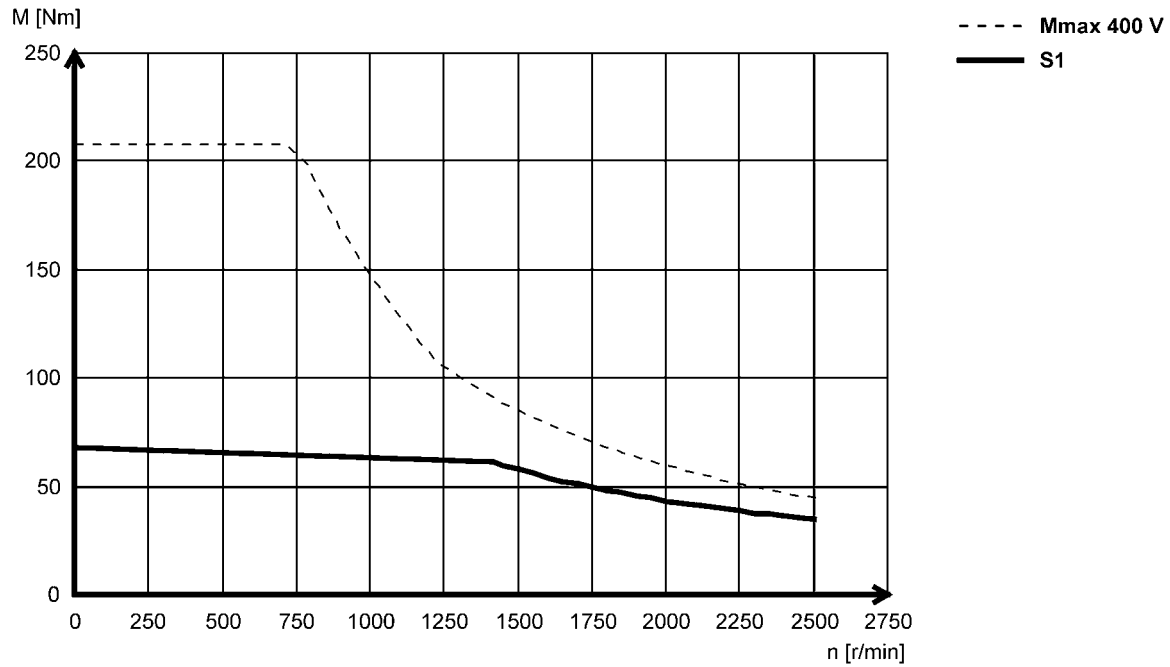

MCA20X29...2F□□ (forced ventilated)

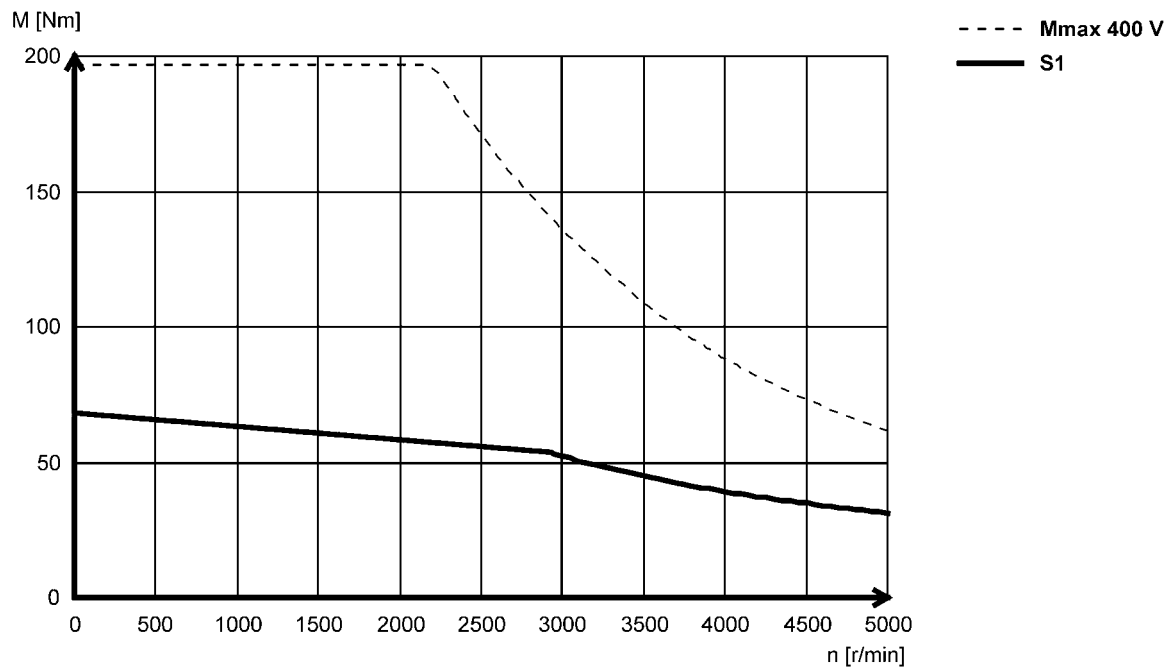

5.5

MCA asynchronous servo motors

Technical data



Torque characteristics

► The data applies to a mains connection voltage of 3 x 400 V.

MCA21X17 (forced ventilated)

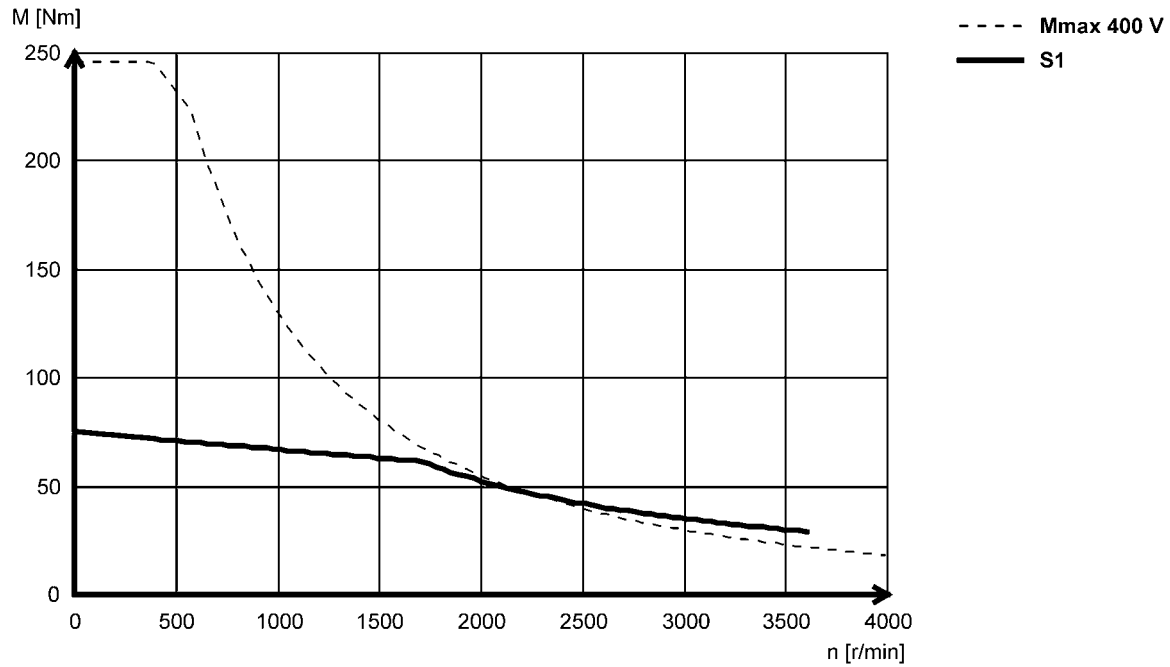

MCA21X25 (non-ventilated)

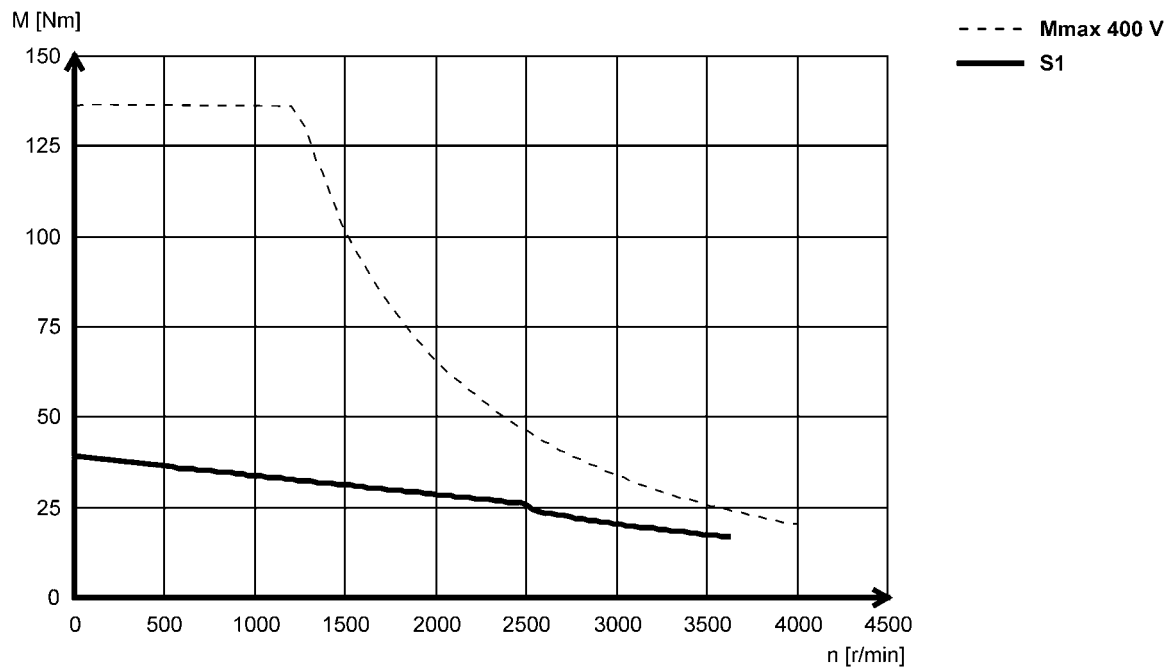

5.5

MCA asynchronous servo motors

Technical data



Torque characteristics

► The data applies to a mains connection voltage of 3 x 400 V.

MCA21X35 (forced ventilated)

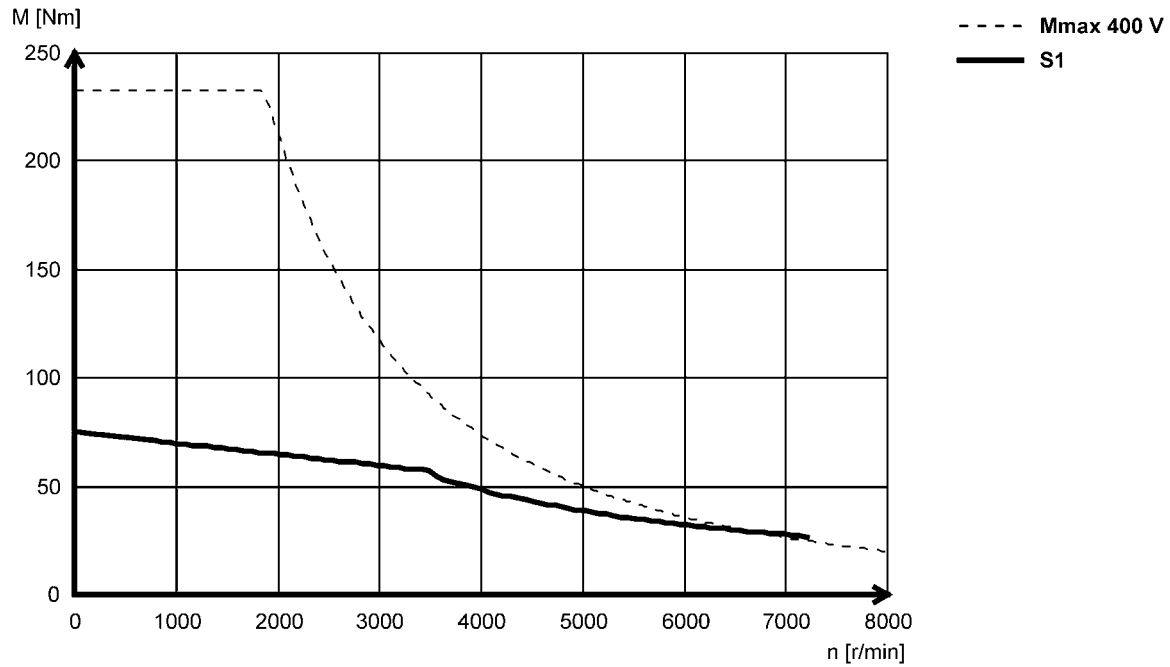

MCA21X42 (non-ventilated)

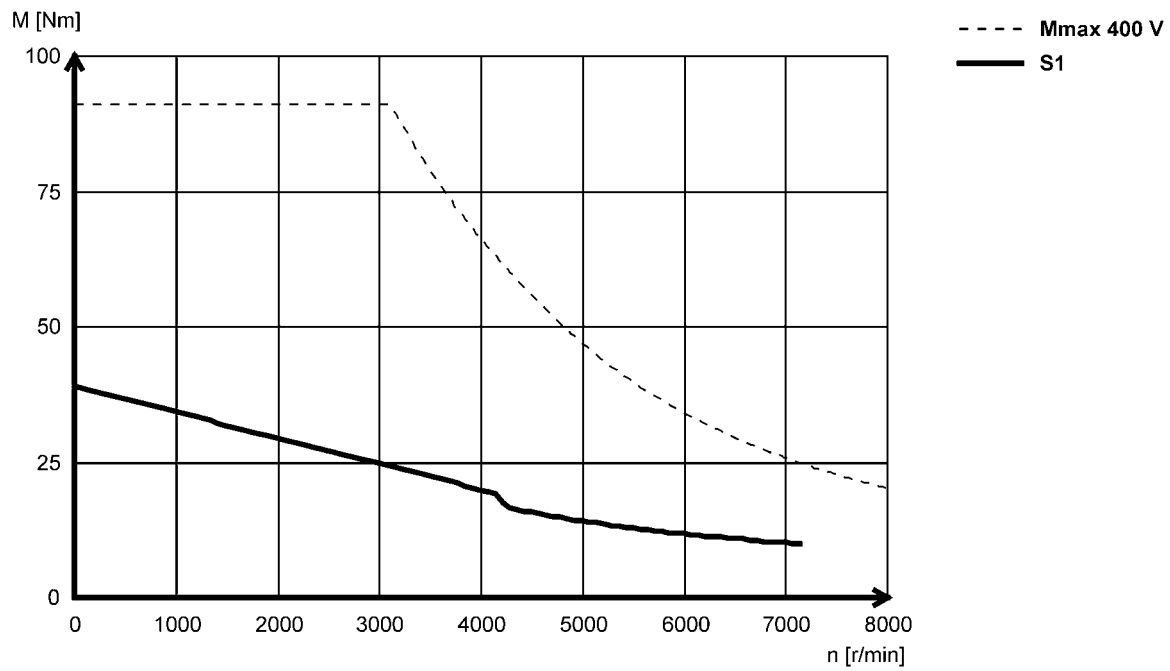

5.5

MCA asynchronous servo motors

Technical data



Torque characteristics

► The data applies to a mains connection voltage of 3 x 400 V.

MCA22P08...5F□□ (forced ventilated)

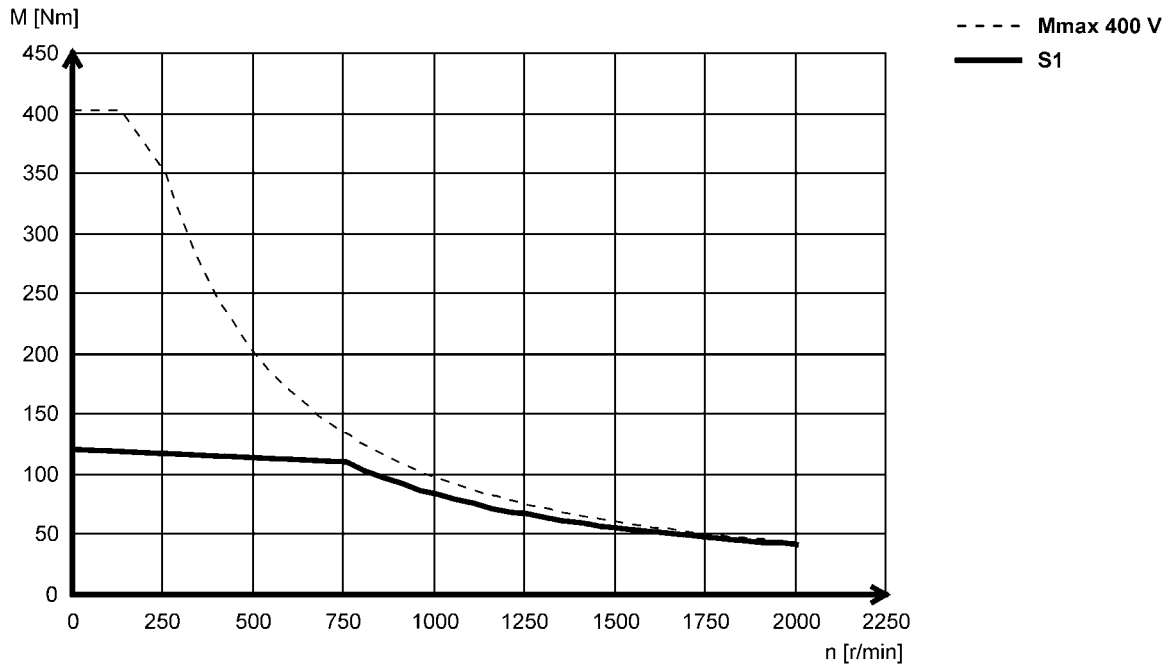

MCA22P08...2F□□ (forced ventilated)

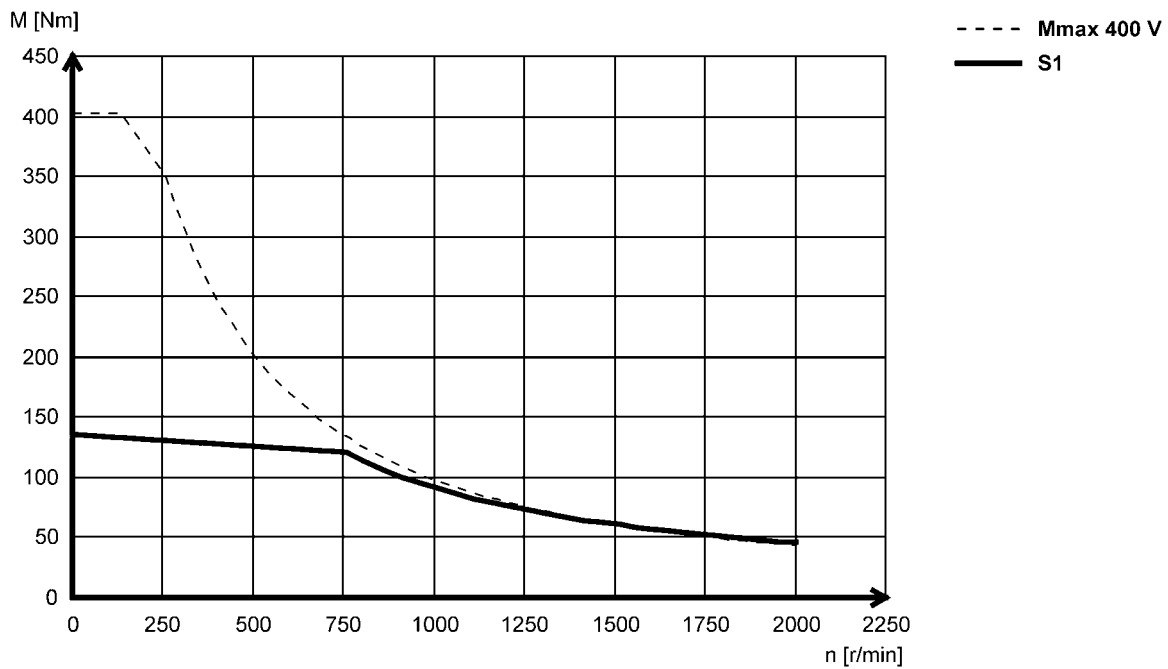

5.5

MCA asynchronous servo motors

Technical data



Torque characteristics

► The data applies to a mains connection voltage of 3 x 400 V.

MCA22P14...5F□□ (forced ventilated)

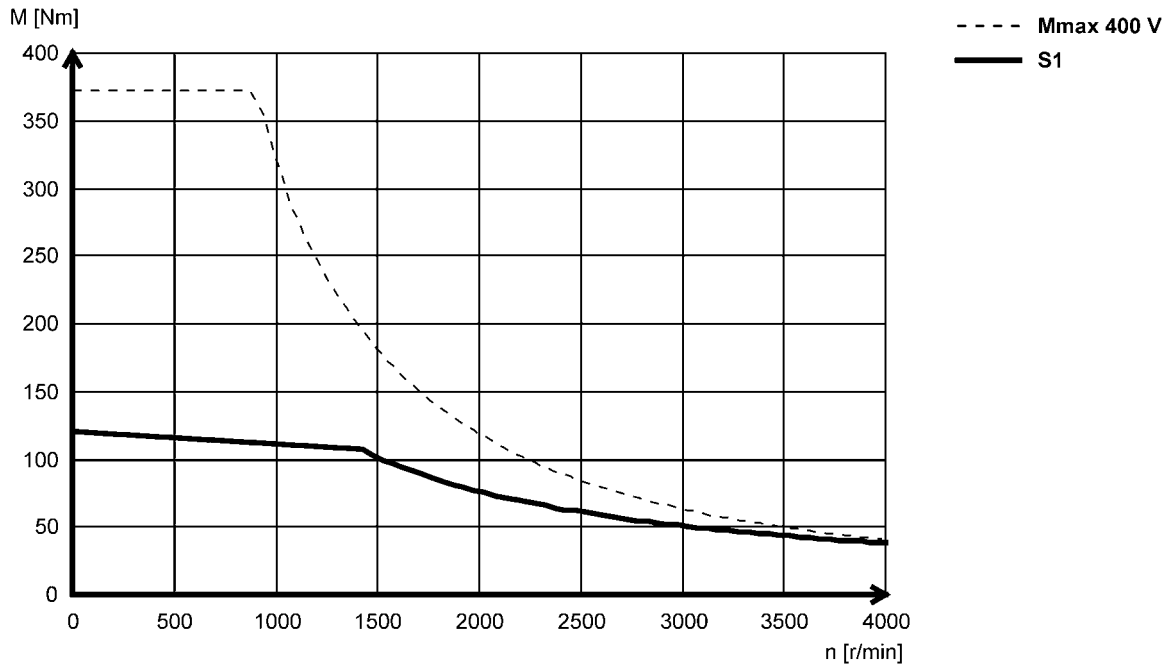

MCA22P14...2F□□ (forced ventilated)

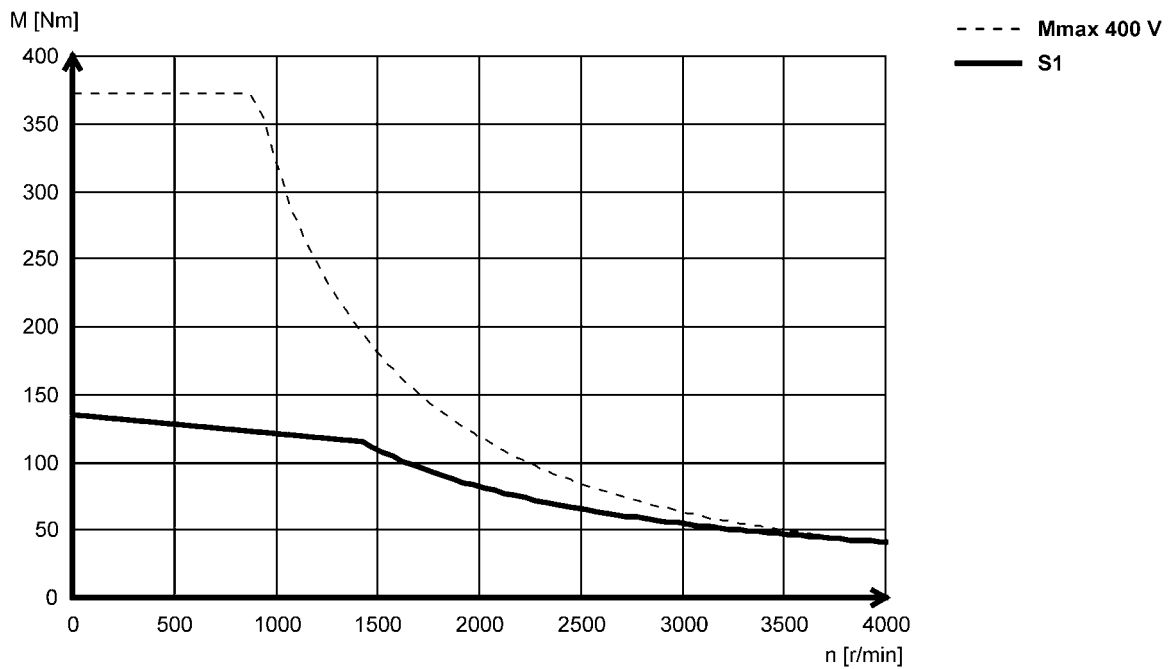

5.5

MCA asynchronous servo motors

Technical data



Torque characteristics

► The data applies to a mains connection voltage of 3 x 400 V.

MCA22P17...5F□□ (forced ventilated)

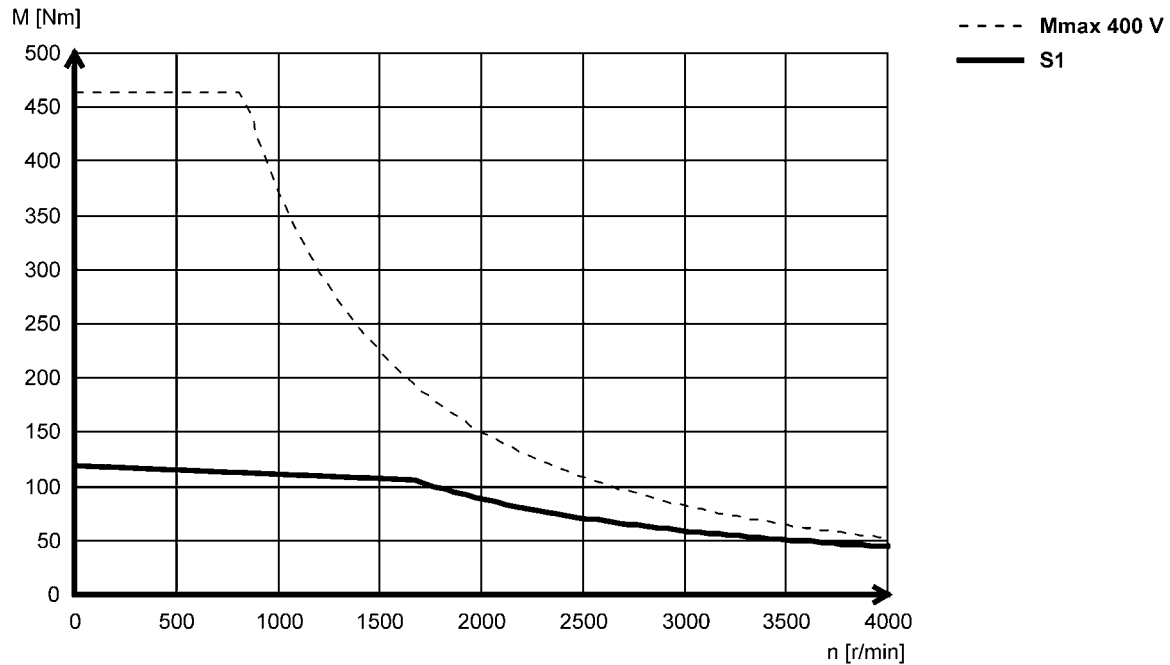

MCA22P17...2F□□ (forced ventilated)

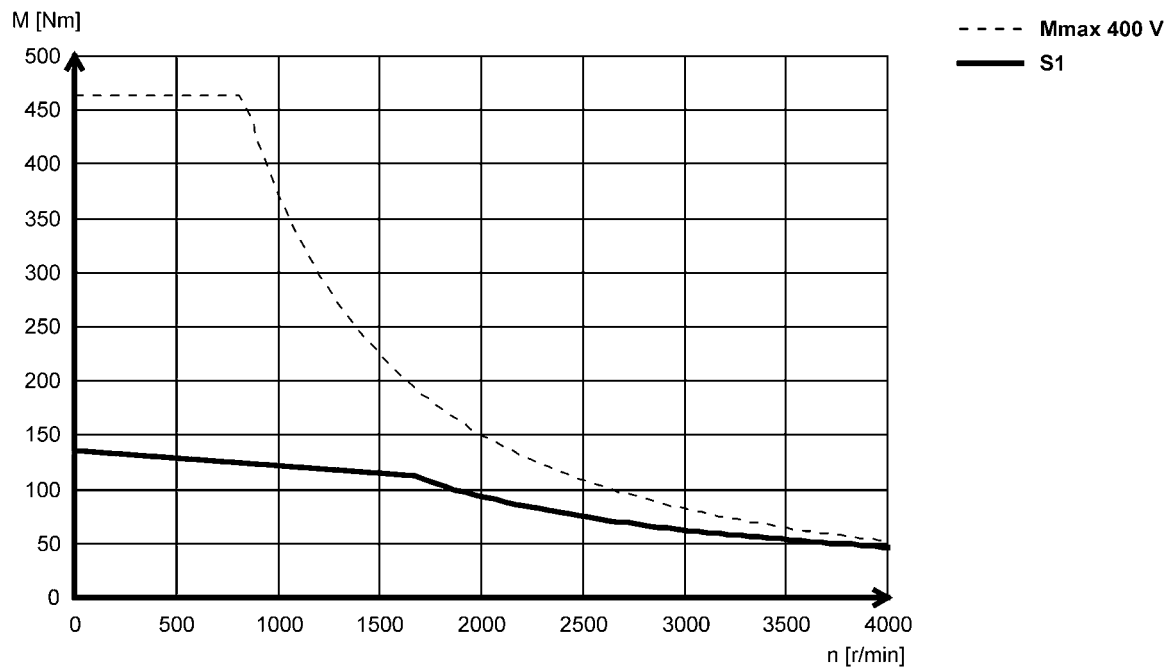

5.5

MCA asynchronous servo motors

Technical data



Torque characteristics

► The data applies to a mains connection voltage of 3 x 400 V.

MCA22P29...5F□□ (forced ventilated)

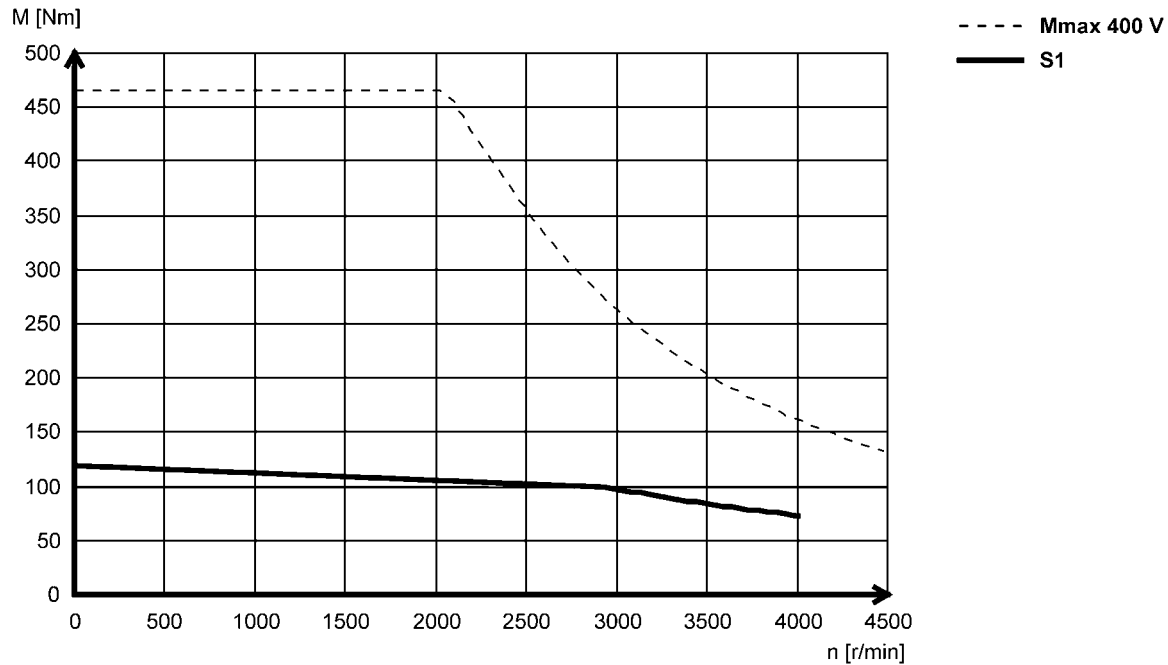

MCA22P29...2F□□ (forced ventilated)

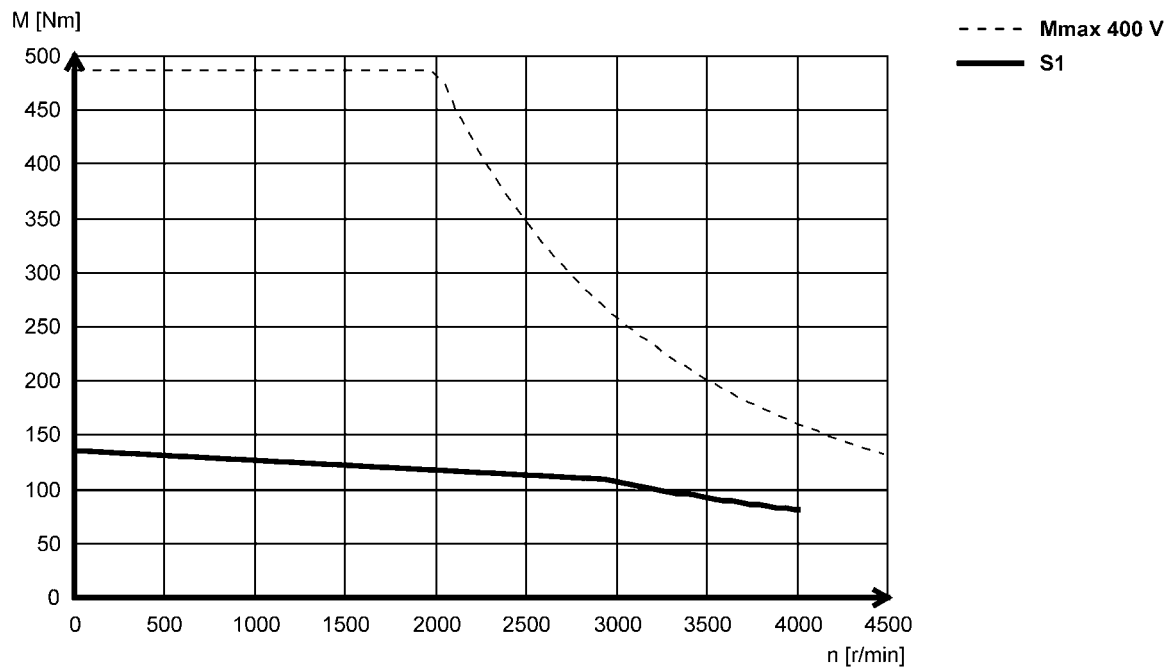

5.5

MCA asynchronous servo motors

Technical data



Torque characteristics

► The data applies to a mains connection voltage of 3 x 400 V.

MCA26T05...5F□□ (forced ventilated)

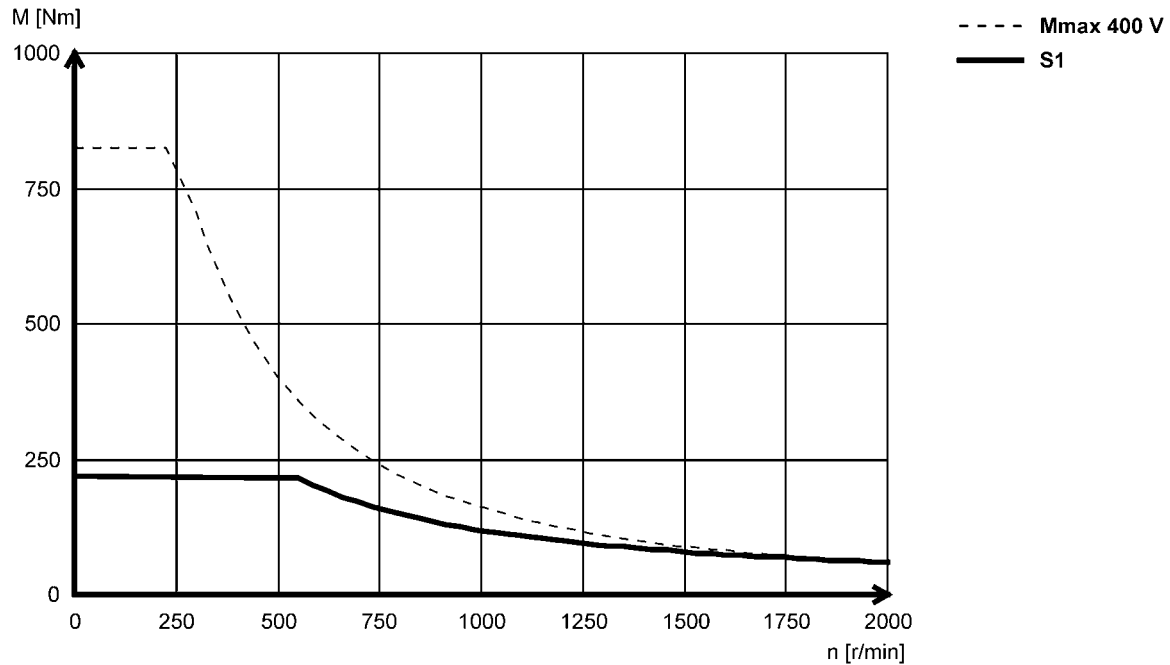

MCA26T05...2F□□ (forced ventilated)

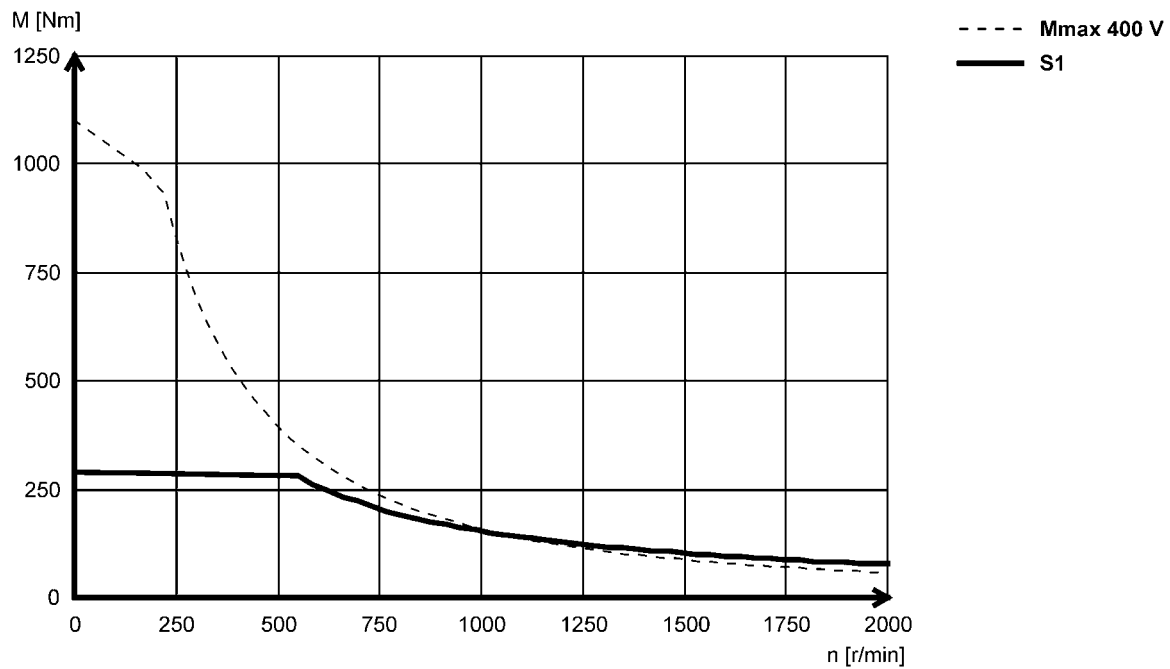

5.5

MCA asynchronous servo motors

Technical data



Torque characteristics

► The data applies to a mains connection voltage of 3 x 400 V.

MCA26T10...5F□□ (forced ventilated)

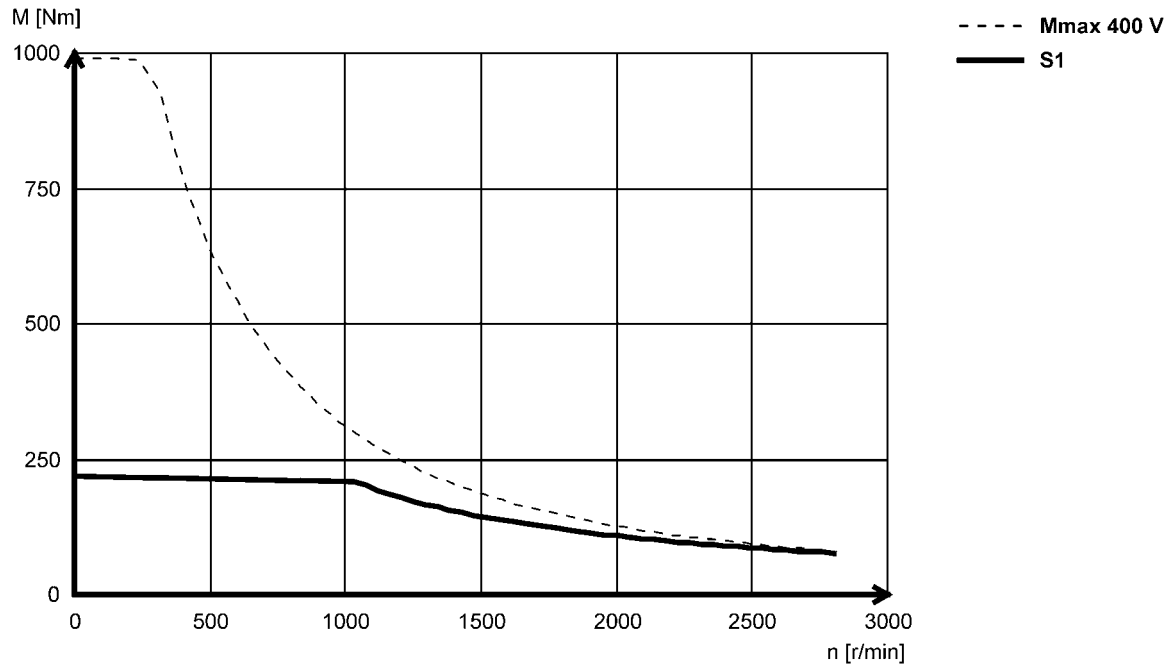

MCA26T10...2F□□ (forced ventilated)

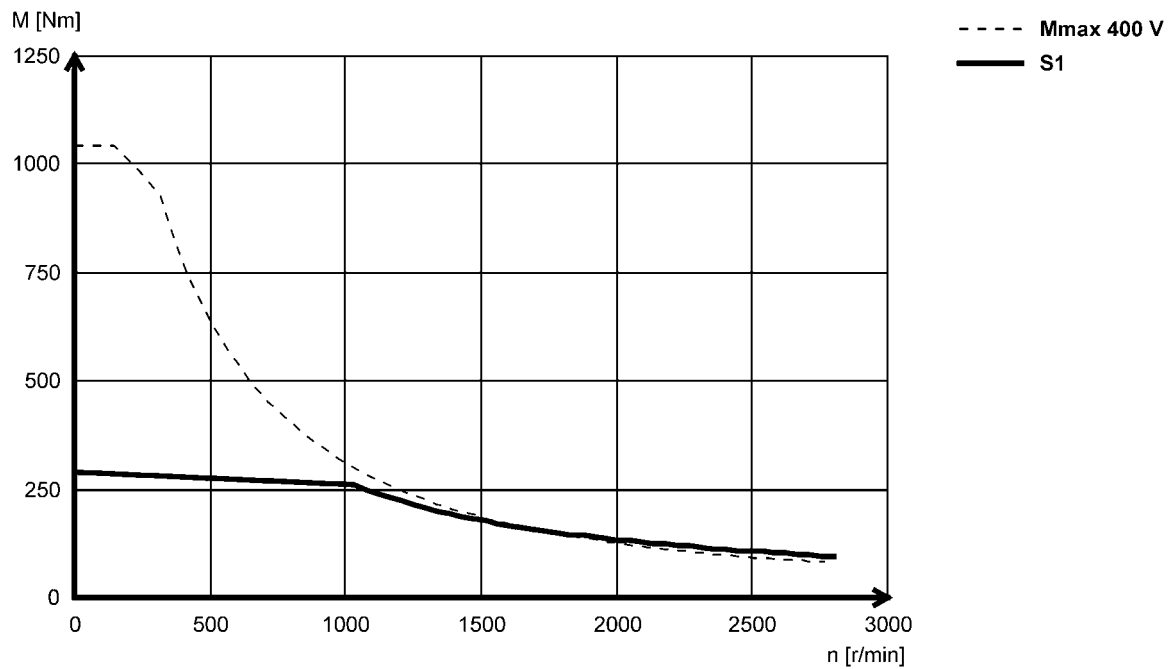

5.5

MCA asynchronous servo motors

Technical data



Torque characteristics

► The data applies to a mains connection voltage of 3 x 400 V.

MCA26T12...5F□□ (forced ventilated)

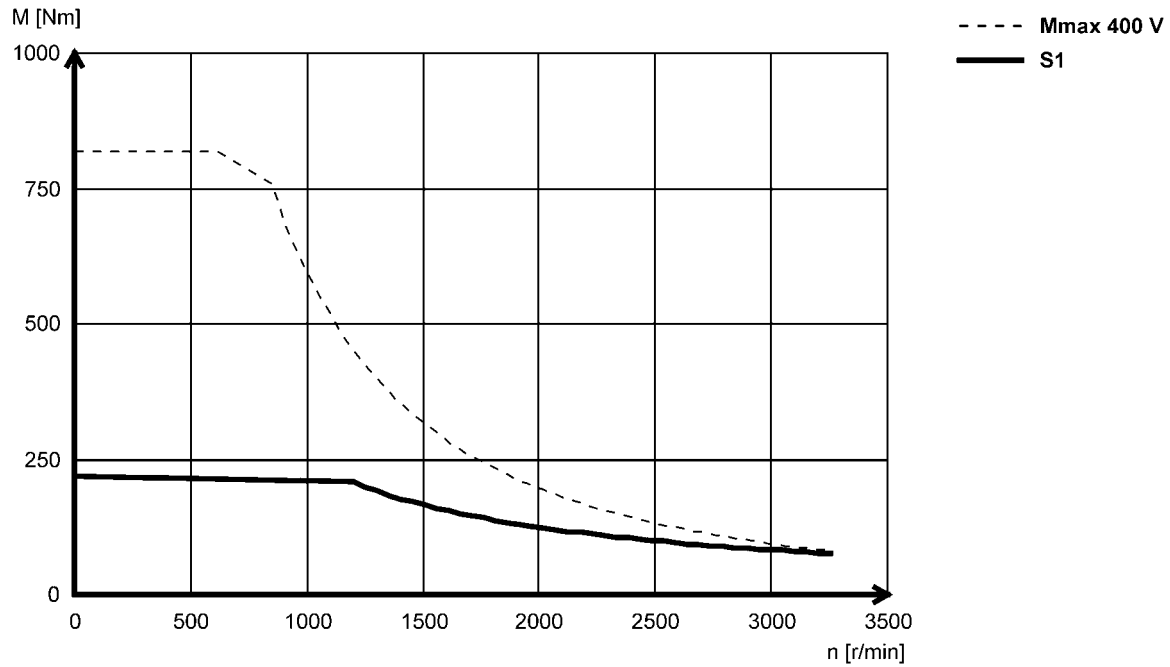

MCA26T12...2F□□ (forced ventilated)

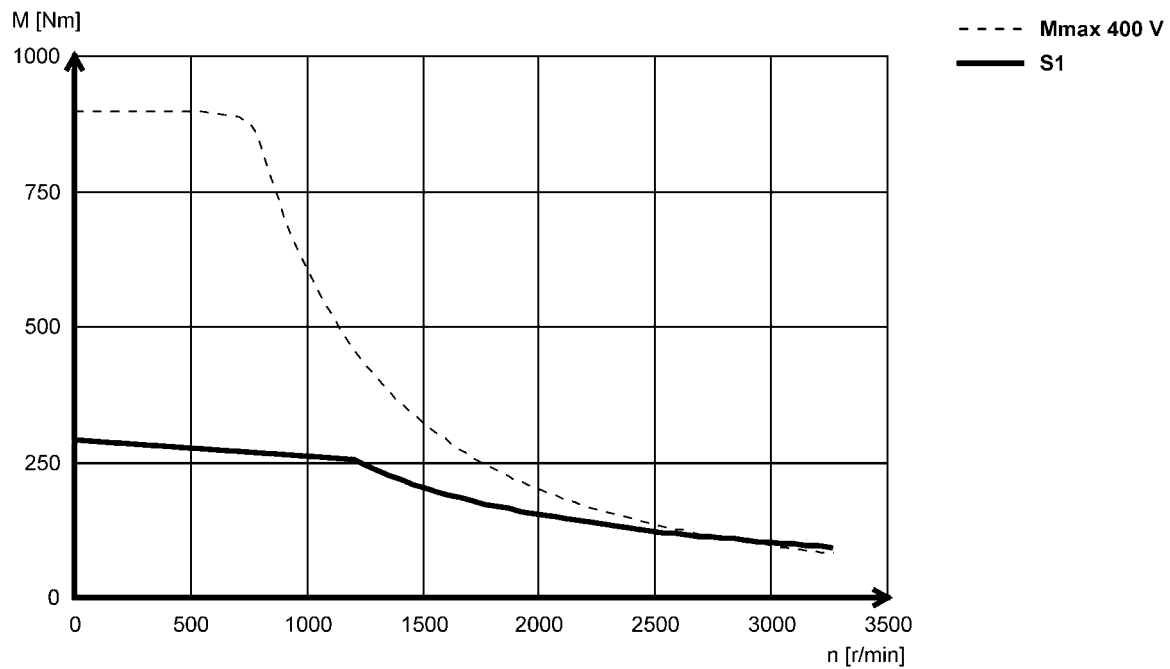

5.5

MCA asynchronous servo motors

Technical data



Torque characteristics

► The data applies to a mains connection voltage of 3 x 400 V.

MCA26T22...5F□□ (forced ventilated)

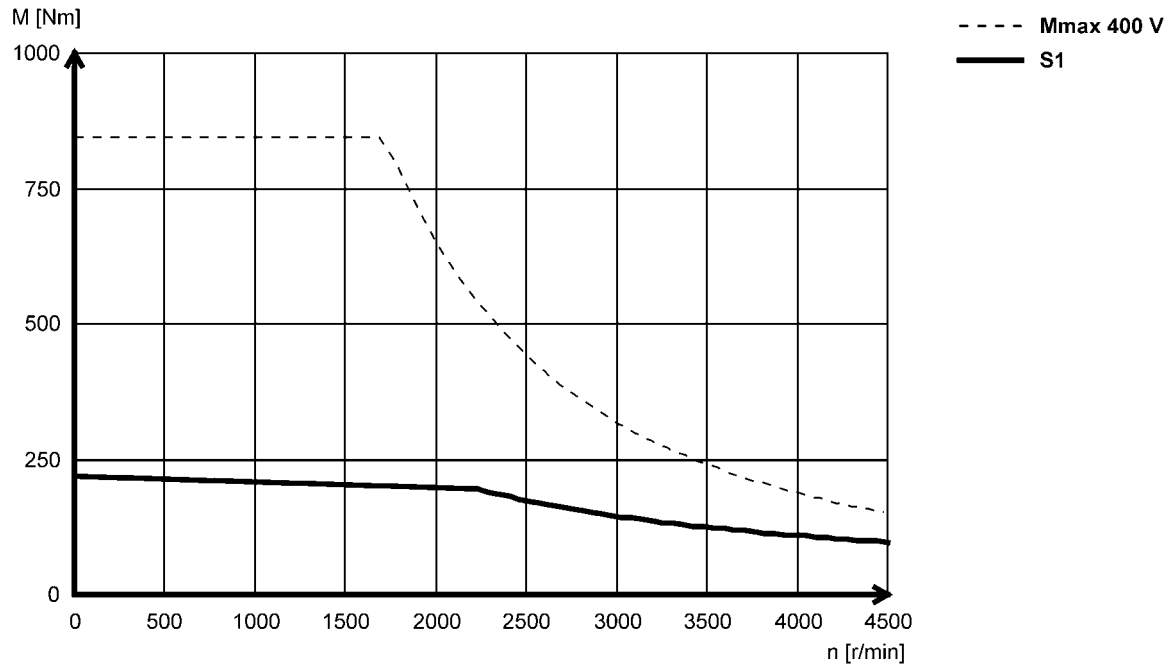

MCA26T22...2F□□ (forced ventilated)

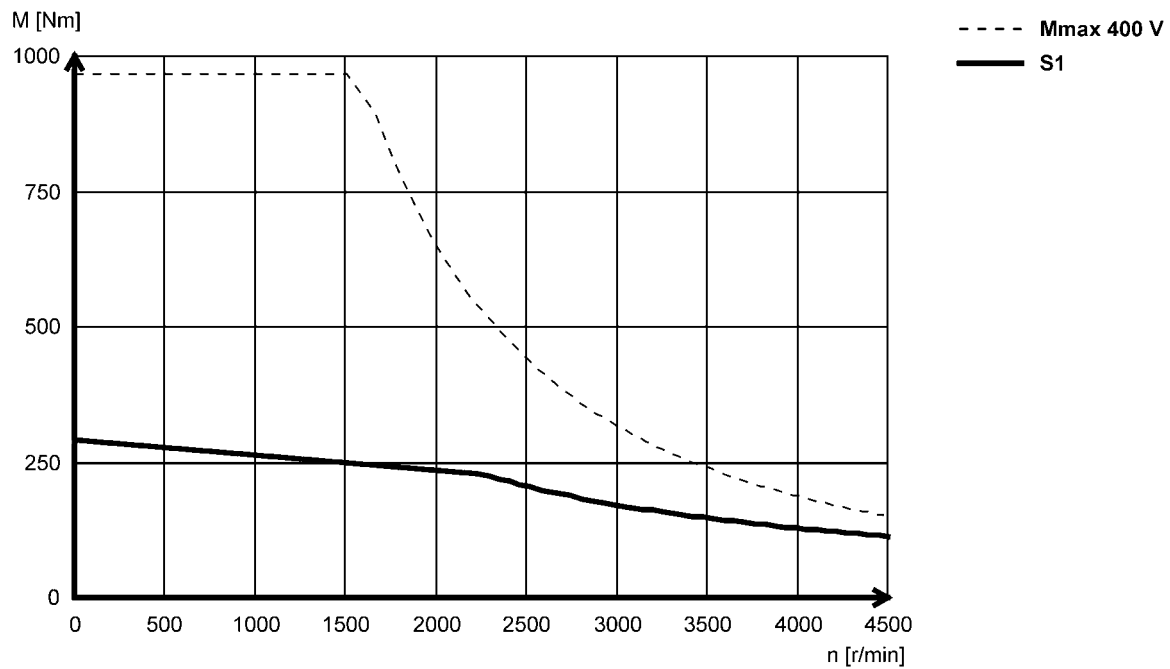

5.5

MCA asynchronous servo motors

Technical data



Dimensions, self-ventilated

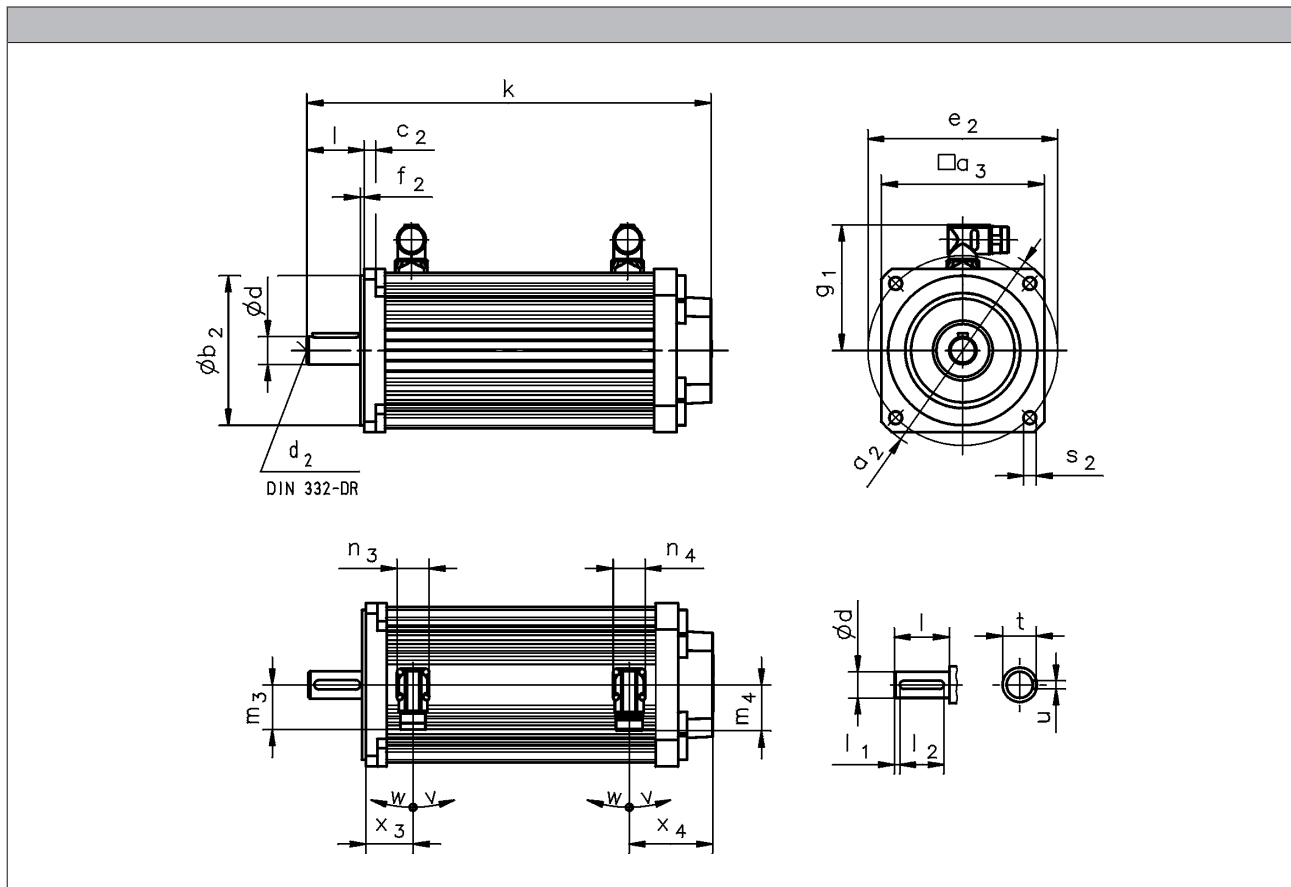

5.5

			MCA10I40	MCA13I41	MCA14L20	MCA17N23	MCA19S23	MCA21X25
					MCA14L41	MCA17N41	MCA19S42	MCA21X42
R□0 B0	k	[mm]	292	311	352	390	461	550
	x ₃	[mm]	37	45	41	43	56	62
	x ₄	[mm]	61	65	73		78	
R□0 P□	k	[mm]	317	346	385	425	499	592
	x ₃	[mm]	59	72	68	75	91	102
	x ₄	[mm]	61	65	73		78	
S□□ / E□□ / T20 / B0	k	[mm]	346	365	407	444	511	599
	x ₃	[mm]	37	45	41	43	56	62
	x ₄	[mm]	115	119	128	127	123	127
S□□ / E□□ / T20 / P□	k	[mm]	371	400	440	479	549	641
	x ₃	[mm]	59	72	68	75	91	102
	x ₄	[mm]	115	119	128	127	123	127

- ▶ Speed/angle sensor: RS0 / S□□ / E□□ / T20
- ▶ Brake: B0 / P□

MCA asynchronous servo motors

Technical data



Dimensions, self-ventilated

	g_1 [mm]	n_3 [mm]	n_4 [mm]	m_3 [mm]	m_4 [mm]	v [°]	w [°]
MCA10I40	90	28	28	40	40	195	80
MCA13I41	102						
MCA14L20	109						
MCA14L41							
MCA17N23	118	40					
MCA17N41							
MCA19S23	151	40	71				
MCA19S42							
MCA21X25	162						
MCA21X42							

	d k6 [mm]	d_2 [mm]	l [mm]	l_1 [mm]	l_2 [mm]	u [mm]	t [mm]
MCA10	14	M5	30	2.5	25	5.0	16.0
MCA13	19	M6	40	2.0	36	6.0	21.5
MCA14	24	M8	50	5.0	40	8.0	27.0
MCA17					50		31.0
MCA19	28	M10	60		70	10.0	41.0
MCA21	38	M12	80				

	a_2 [mm]	a_3 [mm]	b_2 j6 [mm]	c_2 [mm]	e_2 [mm]	f_2 [mm]	s_2 [mm]	
MCA10	120	102	80	8	100	3.0	7	
			70		85	2.5	M6	
MCA13	160	130	110	9	130	3.5	9.0	
								M8
MCA14	188	142	130	10	165			11.0
			110		130		M8	
MCA17	200	165	130	12	165		11.0	
			110		130	M8		
MCA19	250	192	180	11	215	4.0	13.0	
			110		130	3.5	M8	
MCA21	300	214	180	12	215	4.0	13.0	
		250	230		265			
	250	214	110	11	130	3.5	M8	

5.5

MCA asynchronous servo motors

Technical data



Dimensions, forced ventilated

Motors MCA13 to 19/21

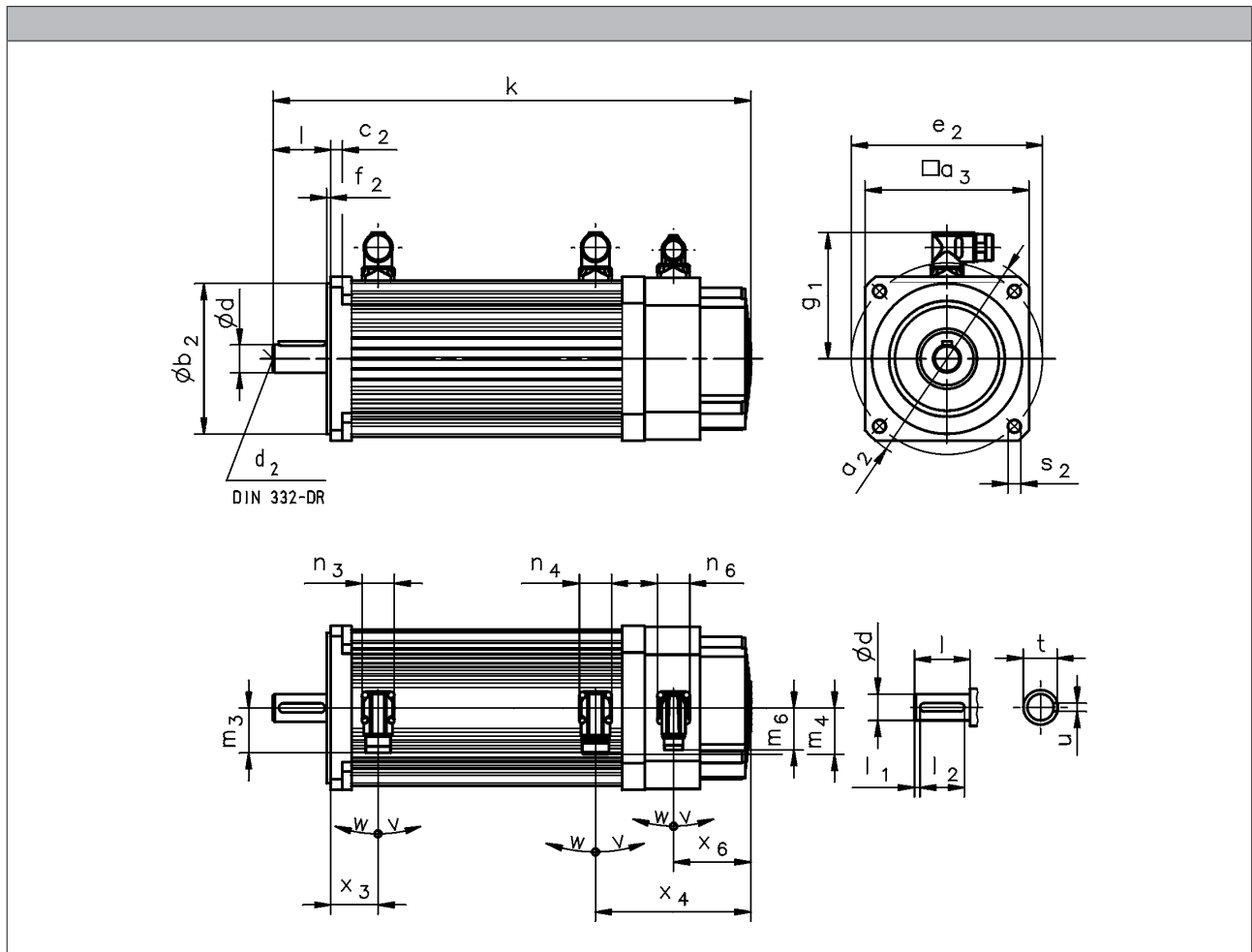

5.5

			MCA13I34	MCA14L16	MCA17N17	MCA19S17	MCA21X17
				MCA14L35	MCA17N35	MCA19S35	MCA21X35
R□0 B0	k	[mm]	379	414	476	558	646
	x ₃	[mm]	45	41	43	56	62
	x ₄	[mm]	133	135	159	170	174
R□0 P□	k	[mm]	414	447	511	596	688
	x ₃	[mm]	72	68	75	91	102
	x ₄	[mm]	133	135	159	170	174
S□□ / E□□ / T20 / B0	k	[mm]	433	469	530	608	695
	x ₃	[mm]	45	41	43	56	62
	x ₄	[mm]	187	190	213	220	223
S□□ / E□□ / T20 / P□	k	[mm]	468	502	565	646	737
	x ₃	[mm]	72	68	75	91	102
	x ₄	[mm]	187	190	213	220	223
	x ₆	[mm]	73	67	94	103	96

- ▶ Speed/angle sensor: RS0 / S□□ / E□□ / T20
- ▶ Brake: B0 / P□

MCA asynchronous servo motors

Technical data



Dimensions, forced ventilated

Motors MCA13 to 19/21

	g ₁	n ₃	n ₄	n ₆	m ₃	m ₄	m ₆	v	w
	[mm]	[mm]	[mm]	[mm]	[mm]	[mm]	[mm]	[°]	[°]
MCA13I34	102	28	28	28	40	40	37	195	80
MCA14L16	109								
MCA14L35	118								
MCA17N17	118								
MCA17N35	151	40			71				
MCA19S17	151								
MCA19S35	162								
MCA21X17	162								
MCA21X35	162								

	d	d ₂	l	l ₁	l ₂	u	t
	k6						
	[mm]	[mm]	[mm]	[mm]	[mm]	[mm]	[mm]
MCA13	19	M6	40	2.0	36	6.0	21.5
MCA14	24	M8	50	5.0	40	8.0	27.0
MCA17					50		31.0
MCA19	28	M10	60		70	10.0	41.0
MCA21	38	M12	80				

	a ₂	a ₃	b ₂	c ₂	e ₂	f ₂	s ₂
			j6				
	[mm]	[mm]	[mm]	[mm]	[mm]	[mm]	[mm]
MCA13	160	130	110	9	130	3.5	9.0
			M8				
MCA14	188	142	130	10	165		11.0
			110		130		M8
MCA17	200	165	130	12	165	11.0	
			110		130	M8	
MCA19	250	192	180	11	215	4.0	13.0
			110		130	3.5	M8
MCA21		214	180		215	4.0	13.0
	300	250	230	12	265		
	250	214	110	11	130	3.5	M8

5.5

MCA asynchronous servo motors

Technical data



Dimensions, forced ventilated

MCA20/22/26 motors in B3 design

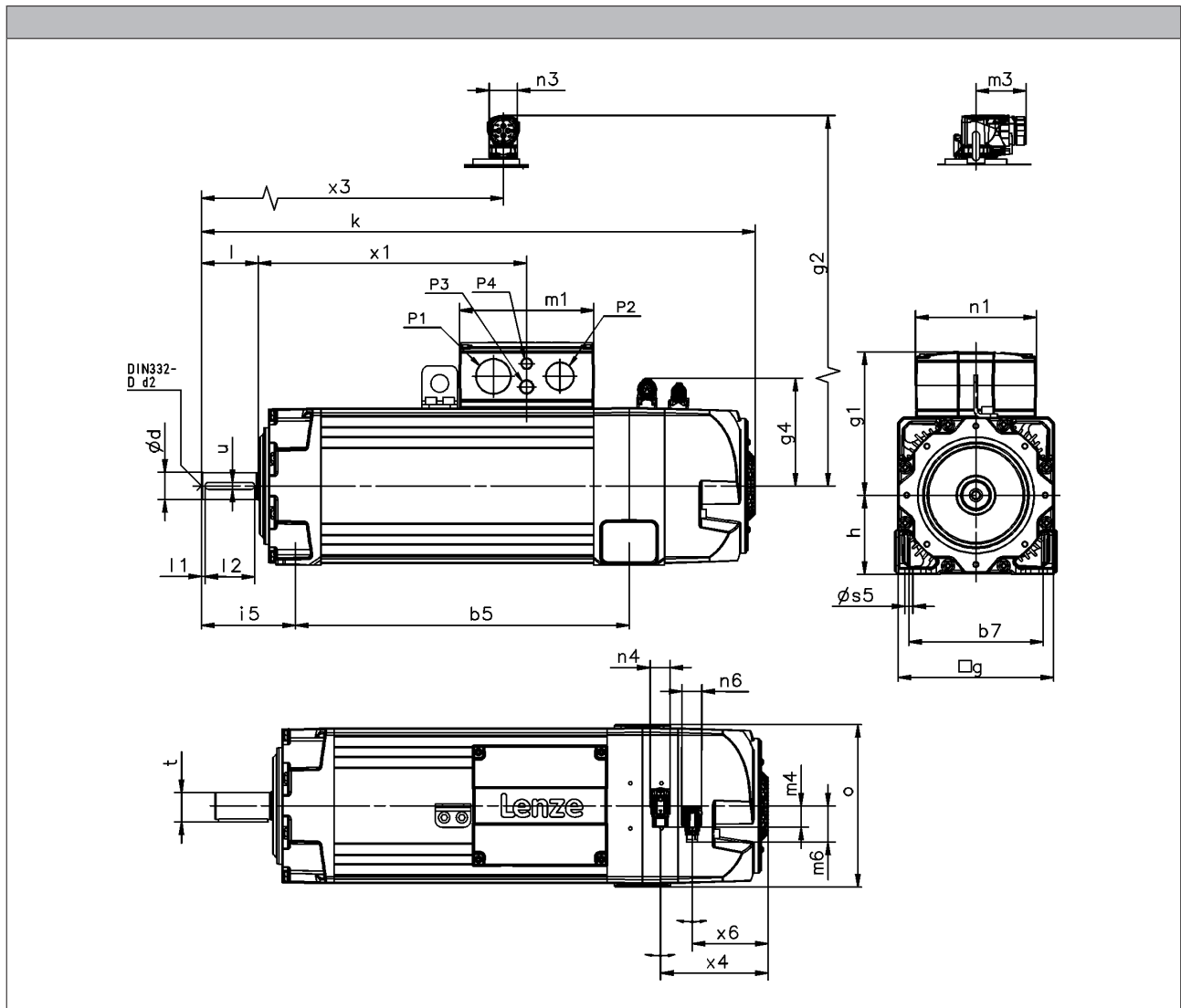

5.5

			MCA20	MCA22	MCA26
R□□ / E□□ / T□□ / S□□ / B0...F10	k	[mm]	666	783	970
R□□ / E□□ / T□□ / S□□ / B0...F1F	k	[mm]	754	865	1022
R□□ / E□□ / T□□ / S□□ / B0	x ₄	[mm]	146	153	194
	m ₄	[mm]	25.0	31.0	25.0
R□□ F1...F10	k	[mm]	753	878	1125
R□□ F1...F1F	k	[mm]	842	959	1177
R□□ F1	x ₄	[mm]	151	157	201
	m ₄	[mm]		31.0	
E□□ / T□□ / S□□ / F1...F10	k	[mm]	797	916	1163
E□□ / T□□ / S□□ / F1...F1F	k	[mm]	885	998	1215
E□□ / T□□ / S□□ / F1	x ₄	[mm]	146	162	200
	m ₄	[mm]		31.0	
R□□ / E□□ / T□□ / S□□ / F2...F10	k	[mm]	822	948	1163
R□□ / E□□ / T□□ / S□□ / F2...F1F	k	[mm]	910	1030	1215
R□□ / E□□ / T□□ / S□□ / F2	x ₄	[mm]	146	162	200
	m ₄	[mm]		31.0	

MCA asynchronous servo motors

Technical data



Dimensions, forced ventilated

MCA20/22/26 motors in B3 design

	g	g ₁	g ₂	g ₄	m ₁	m ₃	m ₆	n ₁	n ₃	n ₄	n ₆
	[mm]	[mm]	[mm]	[mm]	[mm]	[mm]	[mm]	[mm]	[mm]	[mm]	[mm]
MCA20	200	171	168	141	154	72	51	128	40	28	28
MCA22	220	203		153	190			171			
MCA26	260	256		173	234			212			

	o	P ₁	P ₂	P ₃	P ₄	x ₁	x ₃	x ₆
	[mm]	[mm]	[mm]	[mm]	[mm]	[mm]	[mm]	[mm]
MCA20	206	M32x1.5	M25x1.5	M20x1.5	M16x1.5	299	422	101
MCA22	230	M50x1.5	M40x1.5			380		108
MCA26	269	M63x1.5	M50x1.5			465		152

	d	d	d ₂	l	l ₁	l ₂	u	t
	k6	m6		-0.7 ... 0.3				
	[mm]	[mm]	[mm]		[mm]	[mm]	[mm]	[mm]
MCA20	38		M12	80	5.0	70	10.0	41.0
MCA22								
MCA26		55	M20	110		100	16.0	59.0

	h	b ₅	b ₇	s ₅	i ₅
	[mm]	[mm]	[mm]	[mm]	[mm]
MCA20	100	366	160	11.5	134
MCA22	112	472	190		133
MCA26	132	581	215	14.0	165

- ▶ Speed/angle sensor: RS0 / S□□ / E□□ / T□□
- ▶ Brake: B0 / F1 / F2
- ▶ Blower: F10 / F1F

MCA asynchronous servo motors

Technical data



Dimensions, forced ventilated

MCA20/22/26 motors in B35 design

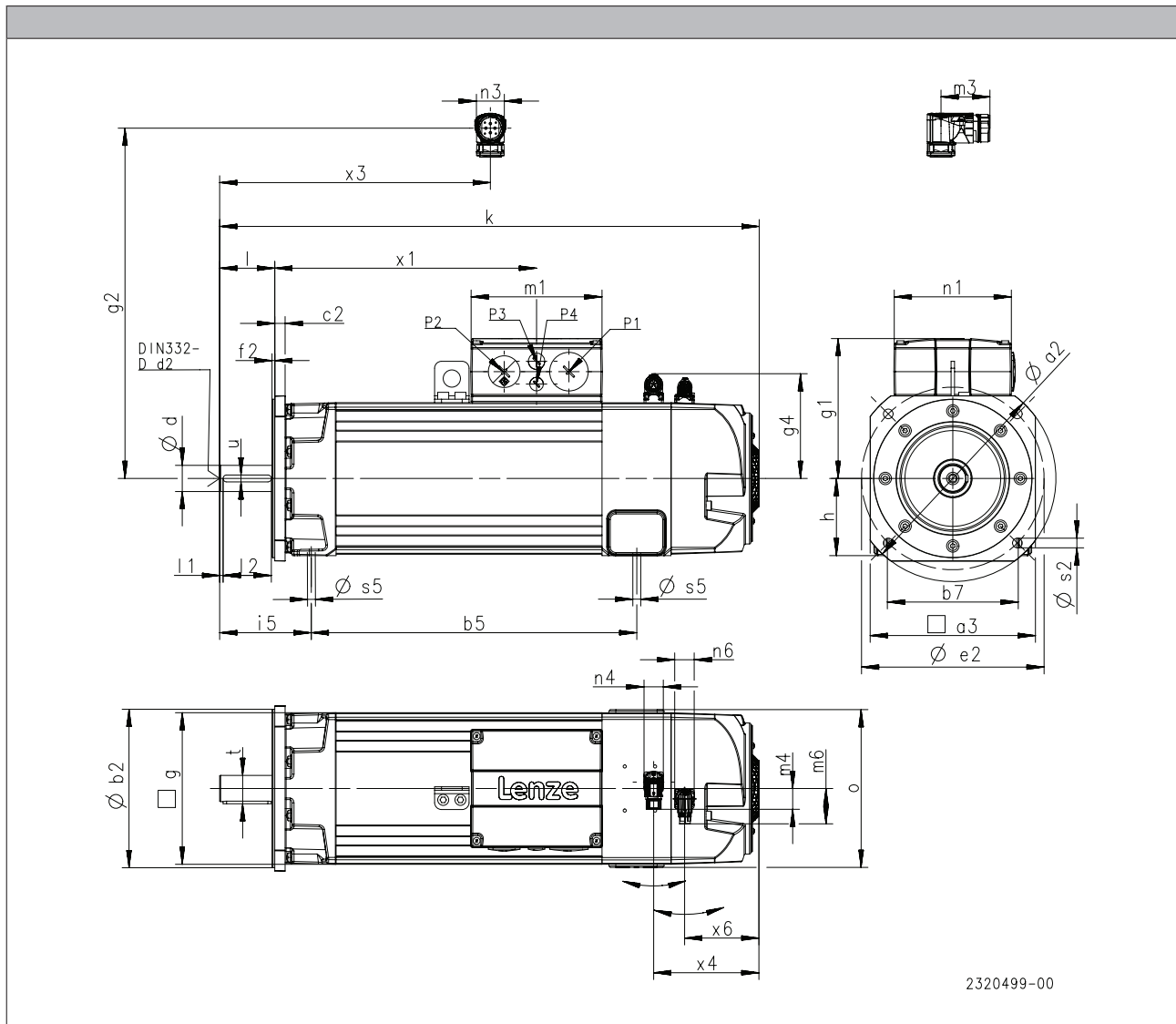

2320499-00

5.5

			MCA20	MCA22	MCA26
R□□ / E□□ / T□□ / S□□ / B0...F10	k	[mm]	666	783	970
R□□ / E□□ / T□□ / S□□ / B0...F1F	k	[mm]	754	865	1022
R□□ / E□□ / T□□ / S□□ / B0	x ₄	[mm]	146	153	194
	m ₄	[mm]	25.0	31.0	25.0
R□□ F1...F10	k	[mm]	753	878	1125
R□□ F1...F1F	k	[mm]	842	959	1177
R□□ F1	x ₄	[mm]	151	157	201
	m ₄	[mm]		31.0	
E□□ / T□□ / S□□ / F1...F10	k	[mm]	797	916	1163
E□□ / T□□ / S□□ / F1...F1F	k	[mm]	885	998	1215
E□□ / T□□ / S□□ / F1	x ₄	[mm]	146	162	200
	m ₄	[mm]		31.0	
R□□ / E□□ / T□□ / S□□ / F2...F10	k	[mm]	822	948	1163
R□□ / E□□ / T□□ / S□□ / F2...F1F	k	[mm]	910	1030	1215
R□□ / E□□ / T□□ / S□□ / F2	x ₄	[mm]	146	162	200
	m ₄	[mm]		31.0	

MCA asynchronous servo motors

Technical data



Dimensions, forced ventilated

MCA20/22/26 motors in B35 design

	g	g ₁	g ₂	g ₄	m ₁	m ₃	m ₆	n ₁	n ₃	n ₄	n ₆
	[mm]	[mm]	[mm]	[mm]	[mm]	[mm]	[mm]	[mm]	[mm]	[mm]	[mm]
MCA20	200	171	168	141	154	72	51	128	40	28	28
MCA22	220	203		153	190			171			
MCA26	260	256		173	234			212			

	o	P ₁	P ₂	P ₃	P ₄	x ₁	x ₃	x ₆
	[mm]	[mm]	[mm]	[mm]	[mm]	[mm]	[mm]	[mm]
MCA20	206	M32x1.5	M25x1.5	M20x1.5	M16x1.5	299	422	101
MCA22	230	M50x1.5	M40x1.5			380		108
MCA26	269	M63x1.5	M50x1.5			465		152

	d	d	d ₂	l	l ₁	l ₂	u	t
	k6	m6		-0.7 ... 0.3				
	[mm]	[mm]	[mm]		[mm]	[mm]	[mm]	[mm]
MCA20	38		M12	80	5.0	70	10.0	41.0
MCA22								
MCA26		55	M20	110		100	16.0	59.0

	h	b ₅	b ₇	s ₅	i ₅
	[mm]	[mm]	[mm]	[mm]	[mm]
MCA20	100	366	160	11.5	134
MCA22	112	472	190		133
MCA26	132	581	215	14.0	165

	a ₂	a ₃	b ₂	b ₂	c ₂	e ₂	f ₂	s ₂
			j6	h6				
	[mm]	[mm]	[mm]	[mm]	[mm]	[mm]	[mm]	[mm]
MCA20	250	196	180		15	215	4.0	14
MCA22	300	240	230			265		
MCA26	400	320				300	350	5.0

- ▶ Speed/angle sensor: RS0 / S□□ / E□□ / T□□
- ▶ Brake: B0 / F1 / F2
- ▶ Blower: F10 / F1F

MCA asynchronous servo motors

Technical data





Permanent magnet holding brake

The asynchronous servo motors MCA10 to 19 and 21 can be fitted with integral permanent magnet holding brakes. In the case of permanent magnet brakes, the rated torque applies solely as holding torque at standstill. This is due to the nature of their design. During braking from full motor speed, e.g. in the event of emergency stops, the braking torque is significantly reduced. As such, they may not be used as safety elements (particularly with lifting axes) without additional measures being implemented. The brakes are activated when the supply voltage is disconnected (closed-circuit principle). When using the brakes purely as holding brakes, virtually no wear occurs on the friction surfaces.

For traversing axes, adherence to the permissible load/brake motor (J_L / J_{MB}) moment of inertia ensures that the permissible maximum switching rate of the brake will not be exceeded and at least 2,000 emergency stop functions can be performed from a speed of 3,000 rpm.

For lifting axes, the load torque resulting from the weight acts additionally. In this case the specifications for J_L / J_{MB} do not apply.

Caution:

The brakes used are not safety brakes in the sense that a reduction in torque may arise as a result of disruptive factors that cannot be influenced, e.g. oil ingress.

The ohmic voltage drop along the cable must be taken into consideration in long motor supply cables and must be compensated for by a higher voltage at the line input.

The following applies for Lenze system cables:

$$U[V] = U_B[V] + 0.08 \frac{[V]}{[A] \cdot [m]} \cdot l_{lg}[m] \cdot I_B[A]$$

If no suitable voltage (incorrect value, incorrect polarity) is applied to the brake, the brake will be applied and can be overheated and destroyed by the motor continuing to rotate.

The shortest switching times of the brakes are achieved by DC switching of the voltage. A spark suppressor is required to suppress interference and to increase the service life of the relay contacts here.



Permanent magnet holding brake



Permanent magnet holding brake

Rated data with standard braking torque

- The figures stated apply to servo motors. They only apply to geared servo motors when the servo motor is connected via a mounting flange.

	$U_{N,DC}^{3,4,7)}$	$U_{N,AC}^{5,7)}$	M_N	M_N	M_{av}	$I_N^{2)}$	J	$t_1^{1)}$	$t_2^{1)}$	$Q_E^{6)}$	m	J_{MB}	J_L/J_{MB}
	[V]	[V]	20 °C	120 °C	120 °C	[A]	[kgcm ²]	[ms]	[ms]	[J]	[kg]	[kgcm ²]	
MCA10	24		3.30	2.50	1.20	0.50	0.38	10.0	20.0	350	0.90	2.78	24.5
	205					0.060							
MCA13	24		12.0	11.0	5.50	0.67	1.06	20.0	29.0	400	0.80	9.36	7.70
	205					0.080							
MCA14	24		15.0	12.0	6.00	0.75	3.60	13.0	30.0	700	1.50	22.8	5.20
	205					0.090							
MCA17	24		24.0	22.0	11.0	0.75	9.50	25.0	50.0	1200	2.70	81.5	3.70
	205					0.090							
MCA19	24		46.0	40.0	18.0	1.00	31.8	53.0	97.0	2800	5.00	212	1.70
	205					0.12							
MCA21	24		88.0	80.0	35.0	1.46	31.8	53.0	97.0	2800	5.00	212	1.70
	205					0.18							

- ¹⁾ Engagement and disengagement times are valid for rated voltage ($\pm 0\%$) and protective circuit for brakes with varistor for DC switching. The times may increase without a protective circuit.
- ²⁾ The currents are the maximum values when the brake is cold (value used for dimensioning the current supply). The values for a motor at operating temperature are considerably lower.
- ³⁾ With 24 V DC brake: smoothed DC voltage, ripple $\leq 1\%$.
With 205 V DC brake: connection to 230 V AC through rectifier.
- ⁴⁾ UR not possible in the case of a brake with a 205 V supply voltage.
- ⁵⁾ UR not possible in the case of a brake with 230 V supply voltage.
- ⁶⁾ Maximum switching energy per emergency stop at $n = 3000$ r/min for at least 2000 emergency stops.
- ⁷⁾ Voltage tolerance: permanent magnet brakes -10% to $+5\%$
spring-applied brakes $\pm 10\%$



Permanent magnet holding brake

Rated data with increased braking torque

- These ratings apply only for geared servo motors with integrated servo motor (without mounting flange).

	U _{N,DC} ^{3,4,7)}	M _N	M _N	M _{av}	I _N ²⁾	J	t ₁ ¹⁾	t ₂ ¹⁾	Q _E ⁶⁾	m	J _{MB}	J _L /J _{MB}
	[V]	20 °C [Nm]	120 °C [Nm]	120 °C [Nm]	[A]	[kgcm ²]	[ms]	[ms]	[J]	[kg]	[kgcm ²]	
MCA10	24	6.00	5.00	2.50	0.67	1.06	20.0	29.0	400	0.80	3.46	22.4
	205				0.80							
MCA13	24	15.0	12.0	6.00	0.75	3.60	13.0	30.0	700	1.50	11.9	8.40
	205				0.090							
MCA14	24	23.0	20.0	10.0	0.92	9.50	18.0	55.0	1350	2.40	22.8	6.60
	205				0.12							
MCA17	24				0.92						45.5	5.00
	205				0.12							
MCA19	24	48.0	40.0	20.0	1.46	31.8	30.0	100	2800	4.80	104	4.50
	205				0.18							
MCA21	24	88.0	80.0	35.0	1.46		53.0	97.0				
	205				0.18							

- 1) Engagement and disengagement times are valid for rated voltage ($\pm 0\%$) and protective circuit for brakes with varistor for DC switching. The times may increase without a protective circuit.
- 2) The currents are the maximum values when the brake is cold (value used for dimensioning the current supply). The values for a motor at operating temperature are considerably lower.
- 3) With 24 V DC brake: smoothed DC voltage, ripple $\leq 1\%$.
With 205 V DC brake: connection to 230 V AC through rectifier.
- 4) UR not possible in the case of a brake with a 205 V supply voltage.
- 5) UR not possible in the case of a brake with 230 V supply voltage.
- 6) Maximum switching energy per emergency stop at $n = 3000$ r/min for at least 2000 emergency stops.
- 7) Voltage tolerance: permanent magnet brakes -10% to +5%
spring-applied brakes $\pm 10\%$



Spring-applied holding brake

Spring-operated holding brakes are available for the asynchronous servo motors MCA20, 22 and 26.

The brakes are activated when the supply voltage is disconnected (closed-circuit principle). When using the brakes purely as holding brakes, virtually no wear occurs on the friction surfaces.

Caution:

The brakes used are not safety brakes in the sense that a reduction in torque may arise as a result of disruptive factors that cannot be influenced, e.g. oil ingress.

The ohmic voltage drop along the cable must be taken into consideration in long motor supply cables and must be compensated for by a higher voltage at the line input.

The following applies for Lenze system cables:

$$U[V] = U_B[V] + 0.08 \frac{[V]}{[A] \cdot [m]} \cdot l_{lg}[m] \cdot I_B[A]$$

If no suitable voltage (incorrect value, incorrect polarity) is applied to the brake, the brake will be applied and can be overheated and destroyed by the motor continuing to rotate.

The shortest switching times of the brakes are achieved by DC switching of the voltage. A spark suppressor is required to suppress interference and to increase the service life of the relay contacts here.



Spring-applied holding brake



Spring-applied holding brake

Rated data with standard braking torque

- The figures stated apply to servo motors. They only apply to geared servo motors when the servo motor is connected via a mounting flange.

	$U_{N,DC}^{3,4,7)}$	$U_{N,AC}^{5,7)}$	M_N	M_N	M_{av}	$I_N^{2)}$	J	$t_1^{1)}$	$t_2^{1)}$	$Q_E^{6)}$	m	J_{MB}	J_L/J_{MB}
	[V]	[V]	[Nm]	[Nm]	[Nm]	[A]	[kgcm ²]	[ms]	[ms]	[J]	[kg]	[kgcm ²]	
MCA20	24	230	90.0	80.0	50.0	3.13	6.88	70.0	220	18000	13.0	177	19.6
	0.37												
MCA22	24	230	150	130	80.0	3.75	18.1	50.0	260	23000	20.5	505	8.20
	0.44					130							
MCA26	24	230	300	260	160	3.75	36.3	175	320	39000	26.0	1405	12.7
	0.37				70.4	360			51000				

Rated data with increased braking torque

- The figures stated apply to servo motors. They only apply to geared servo motors when the servo motor is connected via a mounting flange.

	$U_{N,DC}^{3,4,7)}$	$U_{N,AC}^{5,7)}$	M_N	M_N	M_{av}	$I_N^{2)}$	J	$t_1^{1)}$	$t_2^{1)}$	$Q_E^{6)}$	m	J_{MB}	J_L/J_{MB}
	[V]	[V]	[Nm]	[Nm]	[Nm]	[A]	[kgcm ²]	[ms]	[ms]	[J]	[kg]	[kgcm ²]	
MCA20	24	230	150	130	100	2.58	14.1	70.0	240	31000	15.4	189	33.0
	0.30												
MCA22	24	230	300	260	160	3.75	36.3	175	320	39000	26.0	523	14.1
	0.44					130		310					

- 1) Engagement and disengagement times are valid for rated voltage ($\pm 0\%$) and protective circuit for brakes with varistor for DC switching. The times may increase without a protective circuit.
- 2) The currents are the maximum values when the brake is cold (value used for dimensioning the current supply). The values for a motor at operating temperature are considerably lower.
- 3) With 24 V DC brake: smoothed DC voltage, ripple $\leq 1\%$.
With 205 V DC brake: connection to 230 V AC through rectifier.
- 4) UR not possible in the case of a brake with a 205 V supply voltage.
- 5) UR not possible in the case of a brake with 230 V supply voltage.
- 6) Maximum switching energy per emergency stop at $n = 3000$ rpm for at least 300 emergency stops, maximally 4 emergency stops per hour.
- 7) Voltage tolerance: permanent magnet brakes -10% to +5%
spring-applied brakes $\pm 10\%$

MCA asynchronous servo motors



Accessories

Resolver

Stator-fed resolver with two stator windings offset by 90° and one rotor winding with transformer winding.

- The version MCA20, MCA22 and MCA26 with brake and resolver RV03 is not permissible!

Speed/angle sensor				RS0	RV0
Product key				RS0	RV03
Resolution				RS0	RV03
Angle		[°]		0.80	
Accuracy		[°]		-10 ... 10	
Absolute positioning				1 revolution	
Max. speed	n_{max}	[r/min]		8000	
Max. input voltage					
DC	$U_{in,max}$	[V]		10.0	
Max. input frequency					
	$f_{in,max}$	[kHz]		4.00	
Ratio					
Stator / rotor		± 5 %		0.30	
Rotor impedance	Z_{r0}	[Ω]		51 + j90	
Stator impedance	Z_{s0}	[Ω]		102 + j150	
Impedance	Z_{rs}	[Ω]		44 + j76	
Min. insulation resistance					
At DC 500 V	R	[MΩ]		10.0	
Number of pole pairs				1	
Max. angle error		[°]		-10 ... 10	
Inverter assignment				i700 E84AVTC E94A ECS EVS93	E84AVTC E94A ECS EVS93

¹⁾ 6 - Product key > speed/angle sensor

Speed-dependent safety functions

Suitable for safety function				No	Yes
Max. permissible angular acceleration					
MCA10 ... MCA19 ²⁾	α	[rad/s ²]			22000
MCA20 ... MCA26 ²⁾	α	[rad/s ²]			22000
Functional safety					
IEC 61508					SIL3
EN 13849-1					Up to Performance Level e

²⁾ 1 - Single encoder concepts with resolvers



Incremental encoder and SinCos absolute value encoder

Encoder type			TTL incremental		SinCos incremental	
Speed/angle sensor			T20	T40	S20	S15
Product key			IG2048-5V-T	IG4096-5V-T	IG2048-5V-S	IG1024-5V-V3
Encoder type			Single-turn			
Pulses			2048	4096	2048	1024
Output signals			TTL		1 V _{SS}	
Interfaces			A, B, N track and inverted			
Absolute revolutions			0			
Resolution						
Angle ²⁾		[°]	2.60	1.30	0.40	
Accuracy		[°]	-2 ... 2		-0.8 ... 0.8	
Min. input voltage						
DC	U _{in,min}	[V]	4.75		4.50	4.75
Max. input voltage						
DC	U _{in,max}	[V]	5.25		5.50	5.25
Max. speed						
	n _{max}	[r/min]	8789		5273	8000
Max. current consumption						
	I _{max}	[A]	0.15		0.10	0.070
Limit frequency						
	f _{max}	[kHz]	300		180	200
Inverter assignment			E84AVTC E94A ECS EVS93			E94A

¹⁾ 6 - Product key > speed/angle sensor

²⁾ Inverter-dependent.

Speed-dependent safety functions

Suitable for safety function			No	No	No	Yes
Max. permissible angular acceleration						
MQA20 ... MQA26	α	[rad/s ²]				73 000
Functional safety						
IEC 61508						SIL3
EN 13849-1						Up to Performance Level e



Incremental encoder and SinCos absolute value encoder

Encoder type			SinCos absolute value				
Speed/angle sensor			EQI	SRS	SRM	ECN	EQN
Product key			AM32-5V-E	AS1024-8V-H	AM1024-8V-H	AS2048-5V-E	AM2048-5V-E
Encoder type			Multi-turn	Single-turn	Multi-turn	Single-turn	Multi-turn
Pulses			32	1024		2048	
Output signals			1 Vss				
Interfaces			EnDat	Hiperface	EnDat		
Absolute revolutions			4096	1	4096	1	4096
Resolution							
Angle			[°]				
Accuracy							
			[°]				
Min. input voltage							
DC			$U_{in,min}$ [V]				
			4.75				
Max. input voltage							
DC			$U_{in,max}$ [V]				
			5.25				
Max. speed							
			n_{max} [r/min]				
			12000				
Max. current consumption							
			I_{max} [A]				
			0.17				
Limit frequency							
			f_{max} [kHz]				
			6.00				
Inverter assignment							
			E94A				
			E84AVTC E94A ECS EVS93				
			E94A				

1) 6 - Product key > speed/angle sensor

MCA asynchronous servo motors

Accessories



Blower

Rated data for 50 Hz

		Degree of protection	Number of phases	U_{min} [V]	U_{max} [V]	$U_{N, AC}$ [V]	P_N [kW]	I_N [A]
MCA13	F10	IP54	1	210	240	230	0.019	0.12
MCA14							0.040	0.25
MCA17							0.17	0.73
MCA19							0.060	0.26
MCA20	F10 F1F	IP23s			250		0.24	1.05
MCA21	F10	IP54			240		0.40	1.75
MCA22	F10	IP23s			250			
MCA26	F1F	IP54						

Rated data for 60 Hz

		Degree of protection	Number of phases	U_{min} [V]	U_{max} [V]	$U_{N, AC}$ [V]	P_N [kW]	I_N [A]
MCA13	F10	IP54	1	210	240	230	0.019	0.12
MCA14							0.040	0.25
MCA17							0.20	0.90
MCA19							0.060	0.26
MCA20	F10 F1F	IP23s			250		0.28	1.23
MCA21	F10	IP54			240		0.41	1.82
MCA22	F10	IP23s			250			
MCA26	F1F	IP54						

5.5



Temperature monitoring

The thermal sensors (1x KTY 83-110) used continuously monitor the motor temperature. The temperature signal is transmitted over the system cable of the feedback system to the servo controller. This means that the temperature of the motor is determined with great accuracy in the permitted operating range and at the same time the overtemperature response configured in the controller is executed in the event of overtemperature in one of the winding phases.

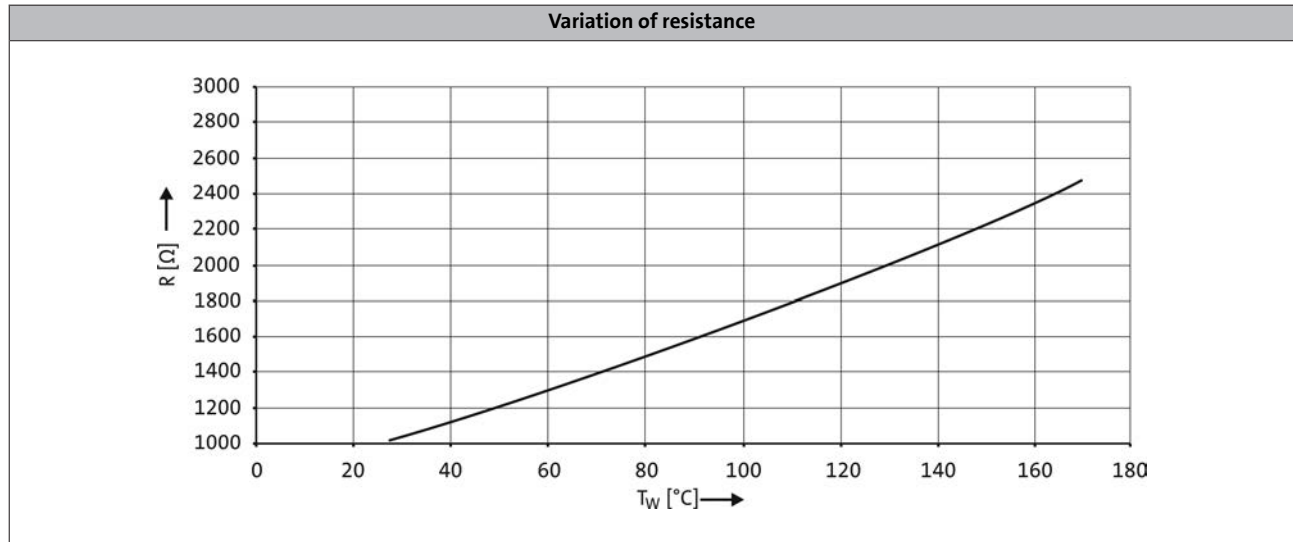

- If the thermal sensor is supplied with a measurement current of 1 mA, the above relationship between the temperature and the resistance applies.

MCA asynchronous servo motors

Accessories



Terminal box

Motors MCA10 to 19/21

If a servo motor is to be connected to an existing cable or plug connectors are not to be used for other reasons, the connection can also be made via a terminal box.

The motor can either be fitted with a terminal box for the power connection and motor holding brake or a second terminal box provided to connect the motor feedback and blower (if applicable).

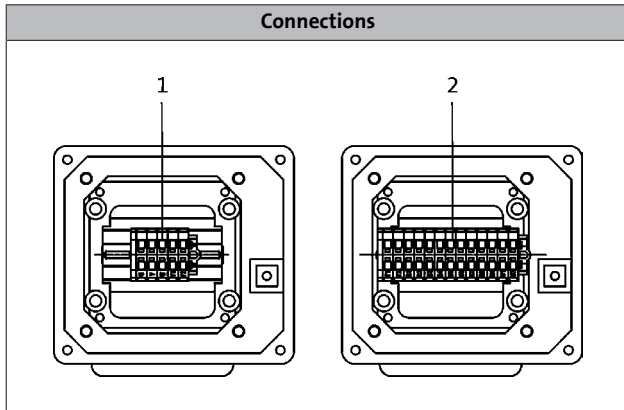

1: Power connection + brake connection + PE connection.

2: Angle/speed sensor connection + thermal sensor connection

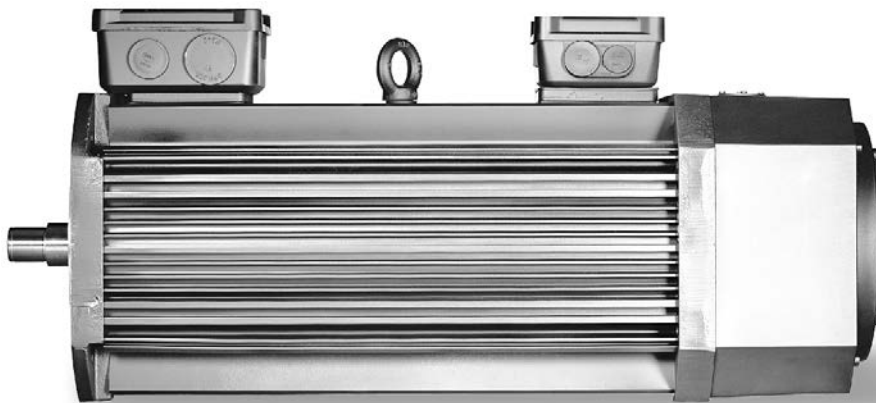

MCA asynchronous servo motors with blower and terminal box

MCA asynchronous servo motors

Accessories



Terminal box

Motors MCA10 to 19/21

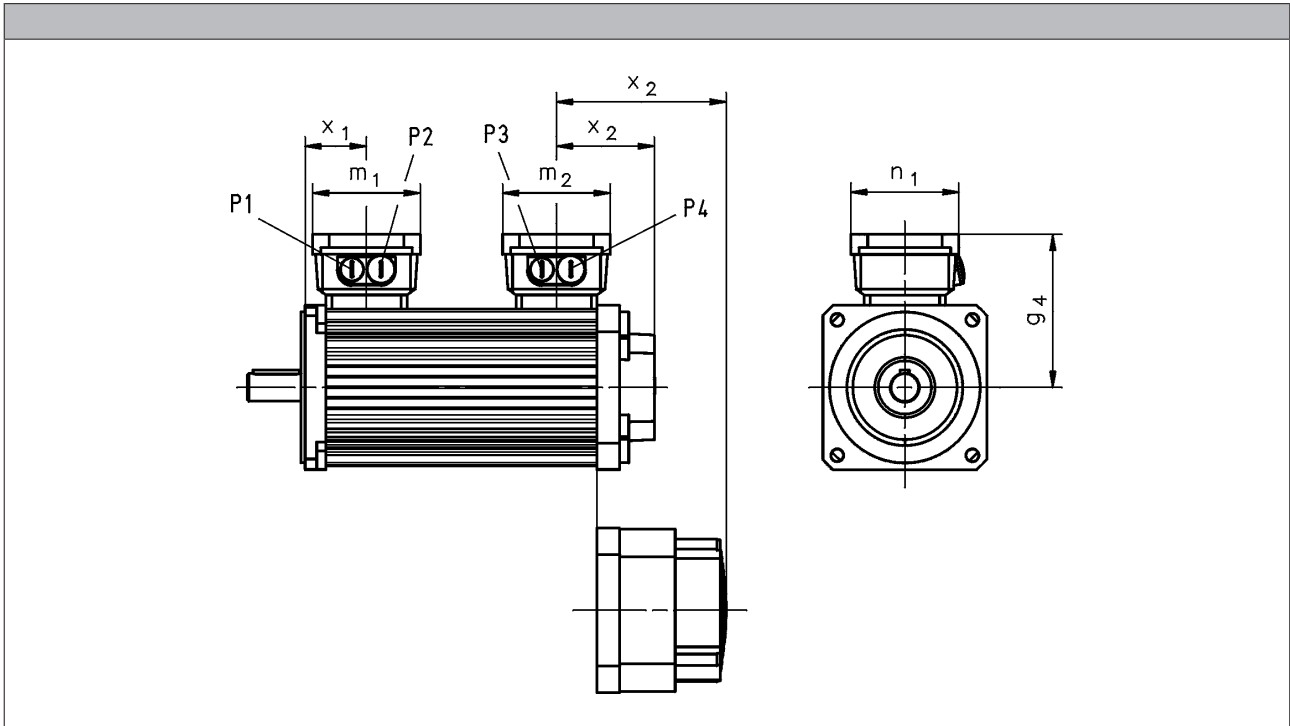

			MCA10I40	MCA13I41	MCA14L20	MCA17N23	MCA19S23	MCA21X25
					MCA14L41	MCA17N41	MCA19S42	MCA21X42
R□0 B0	x ₂	[mm]	78	77	85		93	97
R□0 P□	x ₂	[mm]	78	77	85		93	97
S□□ / E□□ / T20 / B0	x ₂	[mm]	132	131	140	139	143	147
S□□ / E□□ / T20 / P□	x ₂	[mm]	132	131	140	139	143	147

			MCA13I34	MCA14L16	MCA17N17	MCA19S17	MCA21X17
				MCA14L35	MCA17N35	MCA19S35	MCA21X35
R□0 B0	x ₂	[mm]	145	147	171	190	193
R□0 P□	x ₂	[mm]	145	147	171	190	193
S□□ / E□□ / T20 / B0	x ₂	[mm]	199	202	225	240	243
S□□ / E□□ / T20 / P□	x ₂	[mm]	199	202	225	240	243

- ▶ Speed/angle sensor: R50 / S□□ / E□□ / T20
- ▶ Brake: B0 / P□

	g ₄	m ₁	m ₂	n ₁	x ₁	P ₁	P ₂	P ₃	P ₄
	[mm]	[mm]	[mm]	[mm]	[mm]	[mm]	[mm]	[mm]	[mm]
MCA10	113	93	93	93	54	M20x1.5	M20x1.5	M20x1.5	M20x1.5
MCA13	125				57				
MCA14	133				53				
MCA17	141				55				
MCA19	158	115	115	115	64	M25x1.5	M32x1.5	M25x1.5	M20x1.5
MCA21	169				70				

MCA asynchronous servo motors



Accessories

ICN connector

Servo motors MCA10 to 21 provide ICN connectors as standard for electrical connection. Servo motors MCA22 and MCA26 provide a terminal box for electrical connection.

A connector is used for the connection of motor and brake. The connections to the feedback system/temperature monitoring and the blower each employ a separate connector.

The connectors can be rotated through 270° and are fitted with a bayonet catch for SpeedTec connectors. As the connector fixing is also compatible with conventional union nuts. Existing mating connectors can therefore still be used without difficulty.

Connection for power and brake

► MCA10 to 17

Pin assignment		
Contact	Designation	Meaning
1	BD1	Holding brake +
2	BD2	Holding brake -
PE	PE	PE conductor
4	U	Phase U power
5	V	Phase V power
6	W	Phase W power

► MCA19 to 21

Pin assignment		
Contact	Designation	Meaning
1		Not assigned
2		
+	BD1	Holding brake +
-	BD2	Holding brake -
PE	PE	PE conductor
U	U	Phase U power
V	V	Phase V power
W	W	Phase W power

MCA asynchronous servo motors



Accessories

ICN connector

Feedback connection

► Resolver

Pin assignment		
Contact	Designation	Meaning
1	+Ref	Transformer windings
2	-Ref	
3	+VCC ETS	Supply: Electronic nameplate
4	+COS	Cosine stator windings
5	-COS	
6	+SIN	Sine stator windings
7	-SIN	
8		Not assigned
9		
10		
11	+KTY	KTY temperature sensor
12	-KTY	

► Hiperface incremental encoder and SinCos absolute value encoder

Pin assignment		
Contact	Designation	Meaning
1	B	Track B/+SIN
2	A ⁻	Track A inverse/-COS
3	A	Track A/+COS
4	+U _B	Supply +
5	GND	Mass
6	Z ⁻	Zero track inverse/-RS485
7	Z	Zero track/+RS485
8		Not assigned
9	B ⁻	Track B inverse/-SIN
10		Not assigned
11	+KTY	KTY temperature sensor
12	-KTY	

5.5



ICN connector

Feedback connection

- SinCos absolute value encoder with EnDat interface

Pin assignment		
Contact	Designation	Meaning
1	U _p sensor	Supply: UP sensor
2		Not assigned
3		
4	0 V sensor	Supply: 0 V sensor
5	+KTY	KTY temperature sensor
6	-KTY	
7	+U _B	Supply +
8	Cycle	EnDat interface cycle
9	Cycle ⁻	EnDat interface inverse cycle
10	GND	Mass
11	Shield	Encoder housing screen
12	B	Track B
13	B ⁻	Track B inverse/-SIN
14	Data	EnDat interface data
15	A	Track A
16	A ⁻	Track A inverse
17	Data ⁻	EnDat interface inverse data

Blower connection

Pin assignment		
Contact	Designation	Meaning
PE	PE	PE conductor
1	U1	Fan
2	U2	
3		Not assigned
4		
5		
6		

MCA asynchronous servo motors

Technical data



MCA asynchronous servo motors

Technical data



MCA asynchronous servo motors

Technical data



13513046

Lenze SE
Hans-Lenze-Straße 1
D-31855 Aenzen
Phone: +49 (0)5154 82-0
Telefax: +49 (0)5154 82 28 00

www.Lenze.com

Lenze