

CARLO GAVAZZI
Automation Components



Our Products

Sensors

Inductive sensors	8
Capacitive sensors	34
Photoelectric sensors	48
Photoelectric sensors accessories	71
Conductive sensors	74
Magnetic sensors	78
Ultrasonic sensors	85
Motion and presence sensors	94
Environmental sensors	96
Intrinsic safety	100
Safety light curtains	101
Safety magnetic sensors	103
Connectors and brackets	104

Switches

Solid state relays	108
Solid state relays accessories	143
Soft starters	148
Motor protection relays	152
Variable frequency drives	154
Limit switches	157
Electromechanical relays	166
Sockets for electromechanical relays	171

Controls

Energy management	174
Current transformers	184
Energy monitoring solution	192
PV monitoring solution	195
Monitoring relays	200
Timers	212
Counters	217
Surge arresters	220
Digital panel meters	222
Converters and Gateway	226
Safety modules	227
Configurable safety modules	231
Switching power supplies	233

Fieldbuses

Dupline® Home and Building automation	246
Dupline® Parking guidance system	262
Dupline® DuplineSafe	265
Dupline® Industrial	267
Dupline® Irrigation	280
Dupline® Elevator	281



A complete product range

ABOUT CARLO GAVAZZI

Carlo Gavazzi Automation is a multinational electronics group active in the design, manufacture and marketing of electronic equipment targeted at the global markets of industrial and building automation.

Our history is full of firsts and our products are installed in a huge number of applications all over the world. With more than 80 years of successful operation, our experience is unparalleled.

We have our headquarters in Europe and numerous offices around the world.

Our R&D competence centres and production sites are located in Denmark, Italy, Lithuania, Malta and the People's Republic of China.

We operate worldwide through 22 of our own sales companies and also selected representatives in more than 65 countries, from the United States in the West to the Pacific Rim in the East.

Our core competence in automation spans four product lines: Sensors, Switches, Controls and Fieldbuses.

Our wide array of products includes sensors, monitoring relays, timers, energy management systems, solid state relays, safety devices and fieldbus systems.

We focus our expertise on offering state-of-the-art product solutions in selected market segments.

Our customers include original equipment manufacturers of packaging machines, plastic-injection moulding machines, food and beverage production machines, conveying and materials handling equipment, door and entrance control systems, lifts and escalators, as well as heating, ventilation and air-conditioning devices.



A guarantee of reliability

Carlo Gavazzi products earned the independent approval of the relevant bodies which govern our industry and the many markets we serve.

They are developed and manufactured in full compliance with the most important international standard regulations.

Carlo Gavazzi manufacturing facilities operates in line with the requirements of ISO9001:2008 Quality Management Systems and ISO14001:2004 Environmental Management System standard.











Sensors



Inductive sensors	8
Capacitive sensors	34
Photoelectric sensors	48
Photoelectric sensors accessories	71
Conductive sensors	74
Magnetic sensors	78
Ultrasonic sensors	85
Motion and presence sensors	94
Environmental sensors	96
Intrinsic safety	100
Safety light curtains	101
Safety magnetic sensors	103
Connectors and brackets	104

Inductive proximity sensors, 3-wire, DC

Types	M12 Standard - Short body		M12 Standard - Long body	
Connections	2 m cable	M12 connector	2 m cable	M12 connector
Flush mountable				
Dimensions (mm)	M12 x 47	M12 x 50	M12 x 67	M12 x 70
Thread (mm)	M12 x 1 x 30	M12 x 1 x 30	M12 x 1 x 50	M12 x 1 x 50
Operating frequency	2 kHz	2 kHz	2 kHz	2 kHz
Sensing distance (Sn)	2 mm	2 mm	2 mm	2 mm
References				
NPN-NO	ICB12S30F02NO	ICB12S30F02NOM1	ICB12L50F02NO	ICB12L50F02NOM1
PNP-NO	ICB12S30F02PO	ICB12S30F02POM1	ICB12L50F02PO	ICB12L50F02POM1
NPN-NC	ICB12S30F02NC	ICB12S30F02NCM1	ICB12L50F02NC	ICB12L50F02NCM1
PNP-NC	ICB12S30F02PC	ICB12S30F02PCM1	ICB12L50F02PC	ICB12L50F02PCM1

Non-flush mountable				
Dimensions (mm)	M12 x 51	M12 x 54	M12 x 71	M12 x 74
Thread (mm)	M12 x 1 x 30	M12 x 1 x 30	M12 x 1 x 50	M12 x 1 x 50
Operating frequency	2 kHz	2 kHz	2 kHz	2 kHz
Sensing distance (Sn)	4 mm	4 mm	4 mm	4 mm
References				
NPN-NO	ICB12S30N04NO	ICB12S30N04NOM1	ICB12L50N04NO	ICB12L50N04NOM1
PNP-NO	ICB12S30N04PO	ICB12S30N04POM1	ICB12L50N04PO	ICB12L50N04POM1
NPN-NC	ICB12S30N04NC	ICB12S30N04NCM1	ICB12L50N04NC	ICB12L50N04NCM1
PNP-NC	ICB12S30N04PC	ICB12S30N04PCM1	ICB12L50N04PC	ICB12L50N04PCM1

Characteristics flush and non-flush mountable				
Rated operating voltage	10 - 36 VDC	10 - 36 VDC	10 - 36 VDC	10 - 36 VDC
Voltage drop	≤ 2.5 VDC @ 200 mA	≤ 2.5 VDC @ 200 mA	≤ 2.5 VDC @ 200 mA	≤ 2.5 VDC @ 200 mA
Degree of protection	IP 67	IP 67	IP 67	IP 67
Protection Short-circuit (S)				
Reverse polarity (P)	SPT	SPT	SPT	SPT
Transients (T)				
Output current	< 200 mA @ 50°C ≤ 150 mA @ 50-70°C	< 200 mA @ 50°C ≤ 150 mA @ 50-70°C	< 200 mA @ 50°C ≤ 150 mA @ 50-70°C	< 200 mA @ 50°C ≤ 150 mA @ 50-70°C
Housing material	Nickel-plated brass	Nickel-plated brass	Nickel-plated brass	Nickel-plated brass
Operating temperature	-25°C to +70°C	-25°C to +70°C	-25°C to +70°C	-25°C to +70°C
LED colour	Yellow	Yellow	Yellow	Yellow
Approvals/Marks	CE - UL - Cl. I Div. 2	CE - UL - Cl. I Div. 2	CE - UL - Cl. I Div. 2	CE - UL - Cl. I Div. 2

Inductive proximity sensors, 3-wire, DC, extended range

Types	M12 Extended - Extra-short body	M12 Extended - Short body		M12 Extended - Long body	
Connections	2 m cable	2 m cable	M12 connector	2 m cable	M12 connector



Dimensions (mm)	M12 x 25.4	M12 x 47	M12 x 50	M12 x 67	M12 x 70
Thread (mm)	M12 x 1 x 23.4	M12 x 1 x 30	M12 x 1 x 30	M12 x 1 x 50	M12 x 1 x 50
Operating frequency	2 kHz	2 kHz	2 kHz	2 kHz	2 kHz
Sensing distance (Sn)	4 mm	4 mm	4 mm	4 mm	4 mm

References					
NPN-NO	ICB12S23F04NO	ICB12S30F04NO	ICB12S30F04NOM1	ICB12L50F04NO	ICB12L50F04NOM1
PNP-NO	ICB12S23F04PO	ICB12S30F04PO	ICB12S30F04POM1	ICB12L50F04PO	ICB12L50F04POM1
NPN-NC	ICB12S23F04NC	ICB12S30F04NC	ICB12S30F04NCM1	ICB12L50F04NC	ICB12L50F04NCM1
PNP-NC	ICB12S23F04PC	ICB12S30F04PC	ICB12S30F04PCM1	ICB12L50F04PC	ICB12L50F04PCM1



Dimensions (mm)	M12 x 29.4	M12 x 51	M12 x 54	M12 x 71	M12 x 74
Thread (mm)	M12 x 1 x 23.4	M12 x 1 x 30	M12 x 1 x 30	M12 x 1 x 50	M12 x 1 x 50
Operating frequency	2 kHz	2 kHz	2 kHz	2 kHz	2 kHz
Sensing distance (Sn)	8 mm	8 mm	8 mm	8 mm	8 mm

References					
NPN-NO	ICB12S23N08NO	ICB12S30N08NO	ICB12S30N08NOM1	ICB12L50N08NO	ICB12L50N08NOM1
PNP-NO	ICB12S23N08PO	ICB12S30N08PO	ICB12S30N08POM1	ICB12L50N08PO	ICB12L50N08POM1
NPN-NC	ICB12S23N08NC	ICB12S30N08NC	ICB12S30N08NCM1	ICB12L50N08NC	ICB12L50N08NCM1
PNP-NC	ICB12S23N08PC	ICB12S30N08PC	ICB12S30N08PCM1	ICB12L50N08PC	ICB12L50N08PCM1

Characteristics flush and non-flush mountable

Rated operating voltage	10 - 36 VDC	10 - 36 VDC	10 - 36 VDC	10 - 36 VDC	10 - 36 VDC
Voltage drop	≤ 2.5 VDC @ 200 mA	≤ 2.5 VDC @ 200 mA	≤ 2.5 VDC @ 200 mA	≤ 2.5 VDC @ 200 mA	≤ 2.5 VDC @ 200 mA
Degree of protection	IP 67	IP 67	IP 67	IP 67	IP 67
Protection Short-circuit (S) Reverse polarity (P) Transients (T)	SPT	SPT	SPT	SPT	SPT
Output current	≤ 200 mA	≤ 200 mA @ 50°C ≤ 150 mA @ 50-70°C	≤ 200 mA @ 50°C ≤ 150 mA @ 50-70°C	≤ 200 mA @ 50°C ≤ 150 mA @ 50-70°C	≤ 200 mA @ 50°C ≤ 150 mA @ 50-70°C
Housing material	Nickel-plated brass	Nickel-plated brass	Nickel-plated brass	Nickel-plated brass	Nickel-plated brass
Operating temperature	-25°C to +80°C	-25°C to +70°C	-25°C to +70°C	-25°C to +70°C	-25°C to +70°C
LED colour	Yellow	Yellow	Yellow	Yellow	Yellow
Approvals/Marks	CE - UL - Cl. I Div. 2	CE - UL - Cl. I Div. 2	CE - UL - Cl. I Div. 2	CE - UL - Cl. I Div. 2	CE - UL - Cl. I Div. 2

Inductive proximity sensors, 3-wire, DC, increased range

Types	M12 Increased - Short body		M12 Increased - Long body	
Connections	2 m cable	M12 connector	2 m cable	M12 connector

Quasi-flush mountable



Dimensions (mm)	M12 x 48	M12 x 51	M12 x 68	M12 x 71
Thread (mm)	M12 x 1 x 30	M12 x 1 x 30	M12 x 1 x 50	M12 x 1 x 50
Operating frequency	2 kHz	2 kHz	2 kHz	2 kHz
Sensing distance (Sn)	6 mm	6 mm	6 mm	6 mm

References

NPN-NO	ICB12S30F06NO	ICB12S30F06NOM1	ICB12L50F06NO	ICB12L50F06NOM1
PNP-NO	ICB12S30F06PO	ICB12S30F06POM1	ICB12L50F06PO	ICB12L50F06POM1
NPN-NC	ICB12S30F06NC	ICB12S30F06NCM1	ICB12L50F06NC	ICB12L50F06NCM1
PNP-NC	ICB12S30F06PC	ICB12S30F06PCM1	ICB12L50F06PC	ICB12L50F06PCM1

Non-flush mountable



Dimensions (mm)	M12 x 51	M12 x 54	M12 x 71	M12 x 74
Thread (mm)	M12 x 1 x 30	M12 x 1 x 30	M12 x 1 x 50	M12 x 1 x 50
Operating frequency	2 kHz	2 kHz	2 kHz	2 kHz
Sensing distance (Sn)	10 mm	10 mm	10 mm	10 mm





References

NPN-NO	ICB12S30N10NO	ICB12S30N10NOM1	ICB12L50N10NO	ICB12L50N10NOM1
PNP-NO	ICB12S30N10PO	ICB12S30N10POM1	ICB12L50N10PO	ICB12L50N10POM1
NPN-NC	ICB12S30N10NC	ICB12S30N10NCM1	ICB12L50N10NC	ICB12L50N10NCM1
PNP-NC	ICB12S30N10PC	ICB12S30N10PCM1	ICB12L50N10PC	ICB12L50N10PCM1

Characteristics quasi-flush and non-flush mountable

Rated operating voltage	10 - 36 VDC	10 - 36 VDC	10 - 36 VDC	10 - 36 VDC
Voltage drop	≤ 2.5 VDC @ 200 mA	≤ 2.5 VDC @ 200 mA	≤ 2.5 VDC @ 200 mA	≤ 2.5 VDC @ 200 mA
Degree of protection	IP 67	IP 67	IP 67	IP 67
Protection Short-circuit (S) Reverse polarity (P) Transients (T)	SPT	SPT	SPT	SPT
Output current	≤ 200 mA @ 50°C ≤ 150 mA @ 50-70°C	≤ 200 mA @ 50°C ≤ 150 mA @ 50-70°C	≤ 200 mA @ 50°C ≤ 150 mA @ 50-70°C	≤ 200 mA @ 50°C ≤ 150 mA @ 50-70°C
Housing material	Nickel-plated brass	Nickel-plated brass	Nickel-plated brass	Nickel-plated brass
Operating temperature	-25°C to +70°C	-25°C to +70°C	-25°C to +70°C	-25°C to +70°C
LED colour	Yellow	Yellow	Yellow	Yellow
Approvals/Marks	CE - UL - Cl. I Div. 2	CE - UL - Cl. I Div. 2	CE - UL - Cl. I Div. 2	CE - UL - Cl. I Div. 2





Inductive proximity sensors, 3-wire, DC

Types	M18 Standard - Short body		M18 Standard - Long body	
Connections	2 m cable	M12 connector	2 m cable	M12 connector
Flush mountable				
Dimensions (mm)	M18 x 53	M18 x 54	M18 x 73	M18 x 74
Thread (mm)	M18 x 1 x 30	M18 x 1 x 30	M18 x 1 x 50	M18 x 1 x 50
Operating frequency	1.5 kHz	1.5 kHz	1.5 kHz	1.5 kHz
Sensing distance (Sn)	5 mm	5 mm	5 mm	5 mm
References				
NPN-NO	ICB18S30F05NO	ICB18S30F05NOM1	ICB18L50F05NO	ICB18L50F05NOM1
PNP-NO	ICB18S30F05PO	ICB18S30F05POM1	ICB18L50F05PO	ICB18L50F05POM1
NPN-NC	ICB18S30F05NC	ICB18S30F05NCM1	ICB18L50F05NC	ICB18L50F05NCM1
PNP-NC	ICB18S30F05PC	ICB18S30F05PCM1	ICB18L50F05PC	ICB18L50F05PCM1

Non-flush mountable				
Dimensions (mm)	M18 x 63	M18 x 64	M18 x 83	M18 x 84
Thread (mm)	M18 x 1 x 30	M18 x 1 x 30	M18 x 1 x 50	M18 x 1 x 50
Operating frequency	1.5 kHz	1.5 kHz	1.5 kHz	1.5 kHz
Sensing distance (Sn)	8 mm	8 mm	8 mm	8 mm
References				
NPN-NO	ICB18S30N08NO	ICB18S30N08NOM1	ICB18L50N08NO	ICB18L50N08NOM1
PNP-NO	ICB18S30N08PO	ICB18S30N08POM1	ICB18L50N08PO	ICB18L50N08POM1
NPN-NC	ICB18S30N08NC	ICB18S30N08NCM1	ICB18L50N08NC	ICB18L50N08NCM1
PNP-NC	ICB18S30N08PC	ICB18S30N08PCM1	ICB18L50N08PC	ICB18L50N08PCM1

Characteristics flush and non-flush mountable				
Rated operating voltage	10 - 36 VDC	10 - 36 VDC	10 - 36 VDC	10 - 36 VDC
Voltage drop	≤ 2.5 VDC @ 200 mA	≤ 2.5 VDC @ 200 mA	≤ 2.5 VDC @ 200 mA	≤ 2.5 VDC @ 200 mA
Degree of protection	IP 67	IP 67	IP 67	IP 67
Protection Short-circuit (S) Reverse polarity (P) Transients (T)	SPT	SPT	SPT	SPT
Output current	≤ 200 mA @ 50°C ≤ 150 mA @ 50-70°C	≤ 200 mA @ 50°C ≤ 150 mA @ 50-70°C	≤ 200 mA @ 50°C ≤ 150 mA @ 50-70°C	≤ 200 mA @ 50°C ≤ 150 mA @ 50-70°C
Housing material	Nickel-plated brass	Nickel-plated brass	Nickel-plated brass	Nickel-plated brass
Operating temperature	-25°C to +70°C	-25°C to +70°C	-25°C to +70°C	-25°C to +70°C
LED colour	Yellow	Yellow	Yellow	Yellow
Approvals/Marks	CE - UL - Cl. I Div. 2	CE - UL - Cl. I Div. 2	CE - UL - Cl. I Div. 2	CE - UL - Cl. I Div. 2

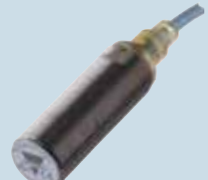
Inductive proximity sensors, 3-wire, DC, extended range





Types	M18 Extended - Short body		M18 Extended - Long body	
Connections	2 m cable	M12 connector	2 m cable	M12 connector
Flush mountable				
Dimensions (mm)	M18 x 53	M18 x 54	M18 x 73	M18 x 74
Thread (mm)	M18 x 1 x 30	M18 x 1 x 30	M18 x 1 x 50	M18 x 1 x 50
Operating frequency	1.5 kHz	1.5 kHz	1.5 kHz	1.5 kHz
Sensing distance (Sn)	8 mm	8 mm	8 mm	8 mm
References				
NPN-NO	ICB18S30F08NO	ICB18S30F08NOM1	ICB18L50F08NO	ICB18L50F08NOM1
PNP-NO	ICB18S30F08PO	ICB18S30F08POM1	ICB18L50F08PO	ICB18L50F08POM1
NPN-NC	ICB18S30F08NC	ICB18S30F08NCM1	ICB18L50F08NC	ICB18L50F08NCM1
PNP-NC	ICB18S30F08PC	ICB18S30F08PCM1	ICB18L50F08PC	ICB18L50F08PCM1





Non-flush mountable				
Dimensions (mm)	M18 x 63	M18 x 64	M18 x 83	M18 x 84
Thread (mm)	M18 x 1 x 30	M18 x 1 x 30	M18 x 1 x 50	M18 x 1 x 50
Operating frequency	1.5 kHz	1.5 kHz	1.5 kHz	1.5 kHz
Sensing distance (Sn)	14 mm	14 mm	14 mm	14 mm
References				
NPN-NO	ICB18S30N14NO	ICB18S30N14NOM1	ICB18L50N14NO	ICB18L50N14NOM1
PNP-NO	ICB18S30N14PO	ICB18S30N14POM1	ICB18L50N14PO	ICB18L50N14POM1
NPN-NC	ICB18S30N14NC	ICB18S30N14NCM1	ICB18L50N14NC	ICB18L50N14NCM1
PNP-NC	ICB18S30N14PC	ICB18S30N14PCM1	ICB18L50N14PC	ICB18L50N14PCM1

Characteristics flush and non-flush mountable

Rated operating voltage	10 - 36 VDC	10 - 36 VDC	10 - 36 VDC	10 - 36 VDC
Voltage drop	≤ 2.5 VDC @ 200 mA	≤ 2.5 VDC @ 200 mA	≤ 2.5 VDC @ 200 mA	≤ 2.5 VDC @ 200 mA
Degree of protection	IP 67	IP 67	IP 67	IP 67
Protection Short-circuit (S) Reverse polarity (P) Transients (T)	SPT	SPT	SPT	SPT
Output current	≤ 200 mA @ 50°C ≤ 150 mA @ 50-70°C	≤ 200 mA @ 50°C ≤ 150 mA @ 50-70°C	≤ 200 mA @ 50°C ≤ 150 mA @ 50-70°C	≤ 200 mA @ 50°C ≤ 150 mA @ 50-70°C
Housing material	Nickel-plated brass	Nickel-plated brass	Nickel-plated brass	Nickel-plated brass
Operating temperature	-25°C to +70°C	-25°C to +70°C	-25°C to +70°C	-25°C to +70°C
LED colour	Yellow	Yellow	Yellow	Yellow
Approvals/Marks	CE - UL - Cl. I Div. 2	CE - UL - Cl. I Div. 2	CE - UL - Cl. I Div. 2	CE - UL - Cl. I Div. 2









Inductive proximity sensors, 3-wire, DC, increased range

Types	M18 Increased - Short body		M18 Increased - Long body	
Connections	2 m cable	M12 connector	2 m cable	M12 connector
Quasi-flush mountable				
Dimensions (mm)	M18 x 54	M18 x 55	M18 x 74	M18 x 75
Thread (mm)	M18 x 1 x 30	M18 x 1 x 30	M18 x 1 x 50	M18 x 1 x 50
Operating frequency	1.5 kHz	1.5 kHz	1.5 kHz	1.5 kHz
Sensing distance (Sn)	12 mm	12 mm	12 mm	12 mm
References				
NPN-NO	ICB18S30F12NO	ICB18S30F12NOM1	ICB18L50F12NO	ICB18L50F12NOM1
PNP-NO	ICB18S30F12PO	ICB18S30F12POM1	ICB18L50F12PO	ICB18L50F12POM1
NPN-NC	ICB18S30F12NC	ICB18S30F12NCM1	ICB18L50F12NC	ICB18L50F12NCM1
PNP-NC	ICB18S30F12PC	ICB18S30F12PCM1	ICB18L50F12PC	ICB18L50F12PCM1

Non-flush mountable				
Dimensions (mm)	M18 x 63	M18 x 64	M18 x 83	M18 x 84
Thread (mm)	M18 x 1 x 30	M18 x 1 x 30	M18 x 1 x 50	M18 x 1 x 50
Operating frequency	1.5 kHz	1.5 kHz	1.5 kHz	1.5 kHz
Sensing distance (Sn)	20 mm	20 mm	20 mm	20 mm
References				
NPN-NO	ICB18S30N20NO	ICB18S30N20NOM1	ICB18L50N20NO	ICB18L50N20NOM1
PNP-NO	ICB18S30N20PO	ICB18S30N20POM1	ICB18L50N20PO	ICB18L50N20POM1
NPN-NC	ICB18S30N20NC	ICB18S30N20NCM1	ICB18L50N20NC	ICB18L50N20NCM1
PNP-NC	ICB18S30N20PC	ICB18S30N20PCM1	ICB18L50N20PC	ICB18L50N20PCM1

Characteristics quasi-flush and non-flush mountable				
Rated operating voltage	10 - 36 VDC	10 - 36 VDC	10 - 36 VDC	10 - 36 VDC
Voltage drop	≤ 2.5 VDC @ 200 mA	≤ 2.5 VDC @ 200 mA	≤ 2.5 VDC @ 200 mA	≤ 2.5 VDC @ 200 mA
Degree of protection	IP 67	IP 67	IP 67	IP 67
Protection Short-circuit (S) Reverse polarity (P) Transients (T)	SPT	SPT	SPT	SPT
Output current	≤ 200 mA @ 50°C ≤ 150 mA @ 50-70°C	≤ 200 mA @ 50°C ≤ 150 mA @ 50-70°C	≤ 200 mA @ 50°C ≤ 150 mA @ 50-70°C	≤ 200 mA @ 50°C ≤ 150 mA @ 50-70°C
Housing material	Nickel-plated brass	Nickel-plated brass	Nickel-plated brass	Nickel-plated brass
Operating temperature	-25°C to +70°C	-25°C to +70°C	-25°C to +70°C	-25°C to +70°C
LED colour	Yellow	Yellow	Yellow	Yellow
Approvals/Marks	CE - UL - Cl. I Div. 2	CE - UL - Cl. I Div. 2	CE - UL - Cl. I Div. 2	CE - UL - Cl. I Div. 2

Inductive proximity sensors, 3-wire, DC

Types	M30 Standard - Short body		M30 Standard - Long body	
Connections	2 m cable	M12 connector	2 m cable	M12 connector
Flush mountable				
Dimensions (mm)	M30 x 43.6	M30 x 55	M30 x 63.6	M30 x 75
Thread (mm)	M30 x 1.5 x 30	M30 x 1.5 x 30	M30 x 1.5 x 50	M30 x 1.5 x 50
Operating frequency	1 kHz	1 kHz	1 kHz	1 kHz
Sensing distance (Sn)	10 mm	10 mm	10 mm	10 mm
References				
NPN-NO	ICB30S30F10NO	ICB30S30F10NOM1	ICB30L50F10NO	ICB30L50F10NOM1
PNP-NO	ICB30S30F10PO	ICB30S30F10POM1	ICB30L50F10PO	ICB30L50F10POM1
NPN-NC	ICB30S30F10NC	ICB30S30F10NCM1	ICB30L50F10NC	ICB30L50F10NCM1
PNP-NC	ICB30S30F10PC	ICB30S30F10PCM1	ICB30L50F10PC	ICB30L50F10PCM1
Non-flush mountable				
Dimensions (mm)	M30 x 55.6	M30 x 67	M30 x 75.6	M30 x 87
Thread (mm)	M30 x 1.5 x 30	M30 x 1.5 x 30	M30 x 1.5 x 50	M30 x 1.5 x 50
Operating frequency	1 kHz	1 kHz	1 kHz	1 kHz
Sensing distance (Sn)	15 mm	15 mm	15 mm	15 mm
References				
NPN-NO	ICB30S30N15NO	ICB30S30N15NOM1	ICB30L50N15NO	ICB30L50N15NOM1
PNP-NO	ICB30S30N15PO	ICB30S30N15POM1	ICB30L50N15PO	ICB30L50N15POM1
NPN-NC	ICB30S30N15NC	ICB30S30N15NCM1	ICB30L50N15NC	ICB30L50N15NCM1
PNP-NC	ICB30S30N15PC	ICB30S30N15PCM1	ICB30L50N15PC	ICB30L50N15PCM1
Characteristics flush and non-flush mountable				
Rated operating voltage	10 - 36 VDC	10 - 36 VDC	10 - 36 VDC	10 - 36 VDC
Voltage drop	≤ 2.5 VDC @ 200 mA	≤ 2.5 VDC @ 200 mA	≤ 2.5 VDC @ 200 mA	≤ 2.5 VDC @ 200 mA
Degree of protection	IP 67	IP 67	IP 67	IP 67
Protection Short-circuit (S) Reverse polarity (P) Transients (T)	SPT	SPT	SPT	SPT
Output current	≤ 200 mA @ 50°C ≤ 150 mA @ 50-70°C	≤ 200 mA @ 50°C ≤ 150 mA @ 50-70°C	≤ 200 mA @ 50°C ≤ 150 mA @ 50-70°C	≤ 200 mA @ 50°C ≤ 150 mA @ 50-70°C
Housing material	Nickel-plated brass	Nickel-plated brass	Nickel-plated brass	Nickel-plated brass
Operating temperature	-25°C to +70°C	-40°C to +70°C	-25°C to +70°C	-40°C to +70°C
LED colour	Yellow	Yellow	Yellow	Yellow
Approvals/Marks	CE - UL - CSA - Cl. I Div. 2	CE - UL - CSA - Cl. I Div. 2	CE - UL - CSA - Cl. I Div. 2	CE - UL - CSA - Cl. I Div. 2

Inductive proximity sensors, 3-wire, DC, extended range

Types	M30 Extended - Short body		M30 Extended - Long body	
Connections	2 m cable	M12 connector	2 m cable	M12 connector



Dimensions (mm)	M30 x 43.6	M30 x 55	M30 x 63.6	M30 x 75
Thread (mm)	M30 x 1.5 x 30	M30 x 1.5 x 30	M30 x 1.5 x 50	M30 x 1.5 x 50
Operating frequency	1 kHz	1 kHz	1 kHz	1 kHz
Sensing distance (Sn)	15 mm	15 mm	15 mm	15 mm

References

NPN-NO	ICB30S30F15NO	ICB30S30F15NOM1	ICB30L50F15NO	ICB30L50F15NOM1
PNP-NO	ICB30S30F15PO	ICB30S30F15POM1	ICB30L50F15PO	ICB30L50F15POM1
NPN-NC	ICB30S30F15NC	ICB30S30F15NCM1	ICB30L50F15NC	ICB30L50F15NCM1
PNP-NC	ICB30S30F15PC	ICB30S30F15PCM1	ICB30L50F15PC	ICB30L50F15PCM1



Dimensions (mm)	M30 x 55.6	M30 x 67	M30 x 75.6	M30 x 87
Thread (mm)	M30 x 1.5 x 30	M30 x 1.5 x 30	M30 x 1.5 x 50	M30 x 1.5 x 50
Operating frequency	1 kHz	1 kHz	1 kHz	1 kHz
Sensing distance (Sn)	22 mm	22 mm	22 mm	22 mm



References





NPN-NO	ICB30S30N22NO	ICB30S30N22NOM1	ICB30L50N22NO	ICB30L50N22NOM1
PNP-NO	ICB30S30N22PO	ICB30S30N22POM1	ICB30L50N22PO	ICB30L50N22POM1
NPN-NC	ICB30S30N22NC	ICB30S30N22NCM1	ICB30L50N22NC	ICB30L50N22NCM1
PNP-NC	ICB30S30N22PC	ICB30S30N22PCM1	ICB30L50N22PC	ICB30L50N22PCM1

Characteristics flush and non-flush mountable

Rated operating voltage	10 - 36 VDC	10 - 36 VDC	10 - 36 VDC	10 - 36 VDC
Voltage drop	≤ 2.5 VDC @ 200 mA	≤ 2.5 VDC @ 200 mA	≤ 2.5 VDC @ 200 mA	≤ 2.5 VDC @ 200 mA
Degree of protection	IP 67	IP 67	IP 67	IP 67
Protection Short-circuit (S) Reverse polarity (P) Transients (T)	SPT	SPT	SPT	SPT
Output current	≤ 200 mA @ 50°C ≤ 150 mA @ 50-70°C	≤ 200 mA @ 50°C ≤ 150 mA @ 50-70°C	≤ 200 mA @ 50°C ≤ 150 mA @ 50-70°C	≤ 200 mA @ 50°C ≤ 150 mA @ 50-70°C
Housing material	Nickel-plated brass	Nickel-plated brass	Nickel-plated brass	Nickel-plated brass
Operating temperature	-25°C to +70°C	-40°C to +70°C	-25°C to +70°C	-40°C to +70°C
LED colour	Yellow	Yellow	Yellow	Yellow
Approvals/Marks	CE - UL - CSA - Cl. I Div. 2	CE - UL - CSA - Cl. I Div. 2	CE - UL - CSA - Cl. I Div. 2	CE - UL - CSA - Cl. I Div. 2

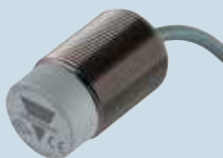
Inductive proximity sensors, 3-wire, DC, increased range

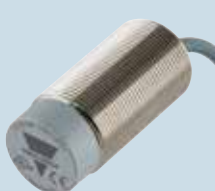
Types	M30 Increased - Short body		M30 Increased - Long body	
Connections	2 m cable	M12 connector	2 m cable	M12 connector
Quasi-flush mountable				
Dimensions (mm)	M30 x 35	M30 x 60	M30 x 50	M30 x 75
Thread (mm)	M30 x 1.5 x 35	M30 x 1.5 x 35	M30 x 1.5 x 50	M30 x 1.5 x 50
Operating frequency	100 Hz	100 Hz	100 Hz	100 Hz
Sensing distance (Sn)	22 mm	22 mm	22 mm	22 mm
References				
NPN-NO	ICB30S35F22NO	ICB30S35F22NOM1	ICB30L50F22NO	ICB30L50F22NOM1
PNP-NO	ICB30S35F22PO	ICB30S35F22POM1	ICB30L50F22PO	ICB30L50F22POM1
NPN-NC	ICB30S35F22NC	ICB30S35F22NCM1	ICB30L50F22NC	ICB30L50F22NCM1
PNP-NC	ICB30S35F22PC	ICB30S35F22PCM1	ICB30L50F22PC	ICB30L50F22PCM1

Non-flush mountable				
Dimensions (mm)	M30 x 47	M30 x 72	M30 x 62	M30 x 87
Thread (mm)	M30 x 1.5 x 35	M30 x 1.5 x 35	M30 x 1.5 x 50	M30 x 1.5 x 50
Operating frequency	100 Hz	100 Hz	100 Hz	100 Hz
Sensing distance (Sn)	40 mm	40 mm	40 mm	40 mm
References				
NPN-NO	ICB30S35N40NO	ICB30S35N40NOM1	ICB30L50N40NO	ICB30L50N40NOM1
PNP-NO	ICB30S35N40PO	ICB30S35N40POM1	ICB30L50N40PO	ICB30L50N40POM1
NPN-NC	ICB30S35N40NC	ICB30S35N40NCM1	ICB30L50N40NC	ICB30L50N40NCM1
PNP-NC	ICB30S35N40PC	ICB30S35N40PCM1	ICB30L50N40PC	ICB30L50N40PCM1





Characteristics quasi-flush and non-flush mountable

Rated operating voltage	10 - 36 VDC	10 - 36 VDC	10 - 36 VDC	10 - 36 VDC
Voltage drop	≤ 2.5 VDC @ 200 mA	≤ 2.5 VDC @ 200 mA	≤ 2.5 VDC @ 200 mA	≤ 2.5 VDC @ 200 mA
Degree of protection	IP 67	IP 67	IP 67	IP 67
Protection Short-circuit (S) Reverse polarity (P) Transients (T)	SPT	SPT	SPT	SPT
Output current	≤ 200 mA @ 50°C ≤ 150 mA @ 50-70°C	≤ 200 mA @ 50°C ≤ 150 mA @ 50-70°C	≤ 200 mA @ 50°C ≤ 150 mA @ 50-70°C	≤ 200 mA @ 50°C ≤ 150 mA @ 50-70°C
Housing material	Nickel-plated brass	Nickel-plated brass	Nickel-plated brass	Nickel-plated brass
Operating temperature	-25°C to +70°C	-25°C to +70°C	-25°C to +70°C	-25°C to +70°C
LED colour	Yellow	Yellow	Yellow	Yellow
Approvals/Marks	CE - UL - Cl. I Div. 2	CE - UL - Cl. I Div. 2	CE - UL - Cl. I Div. 2	CE - UL - Cl. I Div. 2

Inductive proximity sensors, 3-wire, DC, washdown IP69K

Types	M12 Standard - Long body	M12 Extended - Long body	M18 Standard - Long body	M18 Extended - Long body
-------	--------------------------	--------------------------	--------------------------	--------------------------

Connections	M12 connector	M12 connector	M12 connector	M12 connector
-------------	---------------	---------------	---------------	---------------

Flush mountable					
	Dimensions (mm)	M12 x 64.8	M12 x 64.8	M18 x 63	M18 x 63
	Thread (mm)	M12 x 1 x 38.7	M12 x 1 x 38.7	M12 x 1 x 35	M12 x 1 x 35
	Operating frequency	2 kHz	2 kHz	1.5 kHz	1.5 kHz
Sensing distance (Sn)	2 mm	4 mm	5 mm	8 mm	

References				
NPN-NO	ICS12LF02NOM1-FB	ICS12LF04NOM1-FB	ICS18LF05NOM1-FB	ICS18LF08NOM1-FB
PNP-NO	ICS12LF02POM1-FB	ICS12LF04POM1-FB	ICS18LF05POM1-FB	ICS18LF08POM1-FB
NPN-NC	ICS12LF02NCM1-FB	ICS12LF04NCM1-FB	ICS18LF05NCM1-FB	ICS18LF08NCM1-FB
PNP-NC	ICS12LF02PCM1-FB	ICS12LF04PCM1-FB	ICS18LF05PCM1-FB	ICS18LF08PCM1-FB





Non-flush mountable					
	Dimensions (mm)	M12 x 64.8	M12 x 64.8	M18 x 63	M18 x 63
	Thread (mm)	M12 x 1 x 32.5	M12 x 1 x 32.5	M12 x 1 x 27	M12 x 1 x 27
	Operating frequency	2 kHz	2 kHz	1.5 kHz	1.5 kHz
Sensing distance (Sn)	4 mm	8 mm	8 mm	12 mm	

References				
NPN-NO	ICS12LN04NOM1-FB	ICS12LN08NOM1-FB	ICS18LN08NOM1-FB	ICS18LN12NOM1-FB
PNP-NO	ICS12LN04POM1-FB	ICS12LN08POM1-FB	ICS18LN08POM1-FB	ICS18LN12POM1-FB
NPN-NC	ICS12LN04NCM1-FB	ICS12LN08NCM1-FB	ICS18LN08NCM1-FB	ICS18LN12NCM1-FB
PNP-NC	ICS12LN04PCM1-FB	ICS12LN08PCM1-FB	ICS18LN08PCM1-FB	ICS18LN12PCM1-FB

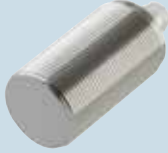
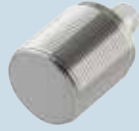
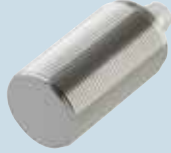
Characteristics flush and non-flush mountable				
Rated operating voltage	10 - 36 VDC	10 - 36 VDC	10 - 36 VDC	10 - 36 VDC
Voltage drop	≤ 2.5 VDC @ 200 mA	≤ 2.5 VDC @ 200 mA	≤ 2.5 VDC @ 200 mA	≤ 2.5 VDC @ 200 mA
Degree of protection	IP 67, IP68, IP69K	IP 67, IP68, IP69K	IP 67, IP68, IP69K	IP 67, IP68, IP69K
Protection Short-circuit (S) Reverse polarity (P) Transients (T)	SPT	SPT	SPT	SPT
Output current	≤ 200 mA @ 50°C ≤ 150 mA @ 50-80°C	≤ 200 mA @ 50°C ≤ 150 mA @ 50-80°C	≤ 200 mA @ 50°C ≤ 150 mA @ 50-80°C	≤ 200 mA @ 50°C ≤ 150 mA @ 50-80°C
Housing material	Stainless steel (AISI 316L)	Stainless steel (AISI 316L)	Stainless steel (AISI 316L)	Stainless steel (AISI 316L)
Front cap material	PPS grey - FDA certified	PPS grey - FDA certified	PPS grey - FDA certified	PPS grey - FDA certified
Operating temperature	-40°C to +80°C	-40°C to +80°C	-40°C to +80°C	-40°C to +80°C
LED colour	Yellow	Yellow	Yellow	Yellow
Approvals/Marks	CE - UL - ECOLAB - Cl. I Div. 2	CE - UL - ECOLAB - Cl. I Div. 2	CE - UL - ECOLAB - Cl. I Div. 2	CE - UL - ECOLAB - Cl. I Div. 2

Inductive proximity sensors, 3-wire, DC, washdown IP69K

Types	M30 Standard		M30 Extended	
	Short body	Long body	Short body	Long body
Connections	M12 connector	M12 connector	M12 connector	M12 connector
Flush mountable				
Dimensions (mm)	M30 x 47	M30 x 67.5	M30 x 47	M30 x 67.5
Thread (mm)	M30 x 1.5 x 30	M30 x 1.5 x 50	M30 x 1.5 x 30	M30 x 1.5 x 50
Operating frequency	1 kHz	1 kHz	1 kHz	1 kHz
Sensing distance (Sn)	10 mm	10 mm	15 mm	15 mm
References				
NPN-NO	ICS30SF10NOM1-FB	ICS30LF10NOM1-FB	ICS30SF15NOM1-FB	ICS30LF15NOM1-FB
PNP-NO	ICS30SF10POM1-FB	ICS30LF10POM1-FB	ICS30SF15POM1-FB	ICS30LF15POM1-FB
NPN-NC	ICS30SF10NCM1-FB	ICS30LF10NCM1-FB	ICS30SF15NCM1-FB	ICS30LF15NCM1-FB
PNP-NC	ICS30SF10PCM1-FB	ICS30LF10PCM1-FB	ICS30SF15PCM1-FB	ICS30LF15PCM1-FB

Non-flush mountable				
Dimensions (mm)	M30 x 59.5	M30 x 79.5	M30 x 59.5	M30 x 79.5
Thread (mm)	M30 x 1.5 x 30	M30 x 1.5 x 50	M30 x 1.5 x 30	M30 x 1.5 x 50
Operating frequency	1 kHz	1 kHz	1 kHz	1 kHz
Sensing distance (Sn)	15 mm	15 mm	22 mm	22 mm
References				
NPN-NO	ICS30SN15NOM1-FB	ICS30LN15NOM1-FB	ICS30SN22NOM1-FB	ICS30LN22NOM1-FB
PNP-NO	ICS30SN15POM1-FB	ICS30LN15POM1-FB	ICS30SN22POM1-FB	ICS30LN22POM1-FB
NPN-NC	ICS30SN15NCM1-FB	ICS30LN15NCM1-FB	ICS30SN22NCM1-FB	ICS30LN22NCM1-FB
PNP-NC	ICS30SN15PCM1-FB	ICS30LN15PCM1-FB	ICS30SN22PCM1-FB	ICS30LN22PCM1-FB

Characteristics flush and non-flush mountable

Rated operating voltage	10 - 36 VDC	10 - 36 VDC	10 - 36 VDC	10 - 36 VDC
Voltage drop	≤ 2 VDC @ 200 mA	≤ 2 VDC @ 200 mA	≤ 2 VDC @ 200 mA	≤ 2 VDC @ 200 mA
Degree of protection	IP67, IP68, IP69K	IP67, IP68, IP69K	IP67, IP68, IP69K	IP67, IP68, IP69K
Protection Short-circuit (S)	SPT	SPT	SPT	SPT
Reverse polarity (P)				
Transients (T)				
Output current	≤ 200 mA @ 50°C ≤ 150 mA @ 50-80°C ≤ 100 mA @ 80-85°C	≤ 200 mA @ 50°C ≤ 150 mA @ 50-80°C ≤ 100 mA @ 80-85°C	≤ 200 mA @ 50°C ≤ 150 mA @ 50-80°C ≤ 100 mA @ 80-85°C	≤ 200 mA @ 50°C ≤ 150 mA @ 50-80°C ≤ 100 mA @ 80-85°C
Housing material	Stainless steel (AISI 316L)	Stainless steel (AISI 316L)	Stainless steel (AISI 316L)	Stainless steel (AISI 316L)
Front cap material	PPS grey - FDA certified	PPS grey - FDA certified	PPS grey - FDA certified	PPS grey - FDA certified
Operating temperature	-40°C to +85°C	-40°C to +85°C	-40°C to +85°C	-40°C to +85°C
LED colour	Yellow	Yellow	Yellow	Yellow
Approvals/Marks	CE - UL - ECOLAB - Cl. I Div. 2	CE - UL - ECOLAB - Cl. I Div. 2	CE - UL - ECOLAB - Cl. I Div. 2	CE - UL - ECOLAB - Cl. I Div. 2

Inductive proximity sensors, 3-wire, DC

Types	M5 Standard - Short body		M8 Standard - Short body	
Connections	2 m cable	M8 connector	2 m cable	M8 connector



Dimensions (mm)	M5 x 26.5	M5 x 40	M8 x 30	M8 x 45
Thread (mm)	M5 x 1 x 20.5	M5 x 1 x 21	M8 x 1 x 30	M8 x 1 x 25
Operating frequency	2 kHz	2 kHz	2 kHz	2 kHz
Sensing distance (Sn)	1 mm (0.8 mm for IA05BSF10NCP)	1 mm	1.5 mm	1.5 mm

References

NPN-NO	IA05BSF10NOP	IA05BSF10NOM5P	IA08BSF15NO	IA08BSF15NOM5
PNP-NO	IA05BSF10POP	IA05BSF10POM5P	IA08BSF15PO	IA08BSF15POM5
NPN-NC	IA05BSF10NCP	IA05BSF10NCM5P	IA08BSF15NC	IA08BSF15NCM5
PNP-NC	IA05BSF10PCP	IA05BSF10PCM5P	IA08BSF15PC	IA08BSF15PCM5

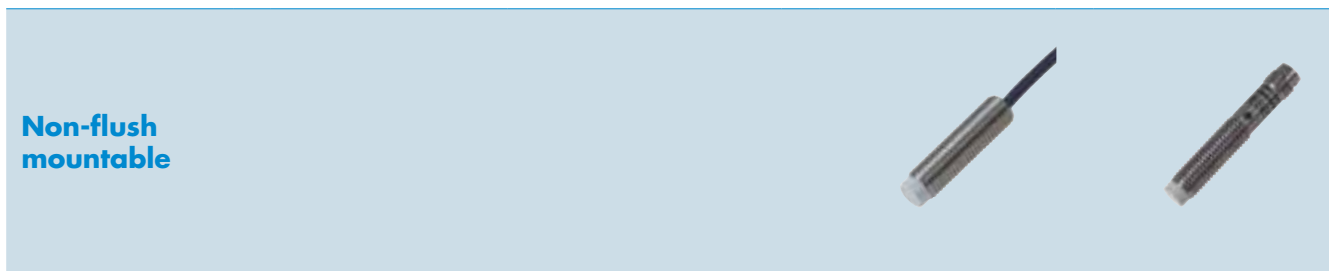

Dimensions (mm)		M8 x 30	M8 x 45
Thread (mm)		M8 x 1 x 27	M8 x 1 x 22
Operating frequency		2 kHz	2 kHz
Sensing distance (Sn)		2.5 mm	2.5 mm

References

NPN-NO		IA08BSN25NO	IA08BSN25NOM5
PNP-NO		IA08BSN25PO	IA08BSN25POM5
NPN-NC		IA08BSN25NC	IA08BSN25NCM5
PNP-NC		IA08BSN25PC	IA08BSN25PCM5

Characteristics flush and non-flush mountable

Rated operating voltage	10 - 30 VDC	10 - 30 VDC	10 - 30 VDC	10 - 30 VDC
Voltage drop	< 1.0 VDC (@ I _{max})	< 1.0 VDC (@ I _{max})	≤ 2.5 VDC (@ I _{max})	≤ 2.5 VDC (@ I _{max})
Degree of protection	IP 67	IP 67	IP 67	IP 67
Protection Short-circuit (S)				
Reverse polarity (P)	SP	SP	SP	SP
Transients (T)				
Output current	≤ 200 mA	≤ 200 mA	≤ 200 mA @ 25°C	≤ 200 mA @ 25°C
Housing material	Stainless steel	Stainless steel	Stainless steel	Stainless steel
Operating temperature	-25°C to +70°C	-25°C to +70°C	-25°C to +70°C	-25°C to +70°C
LED colour	Yellow	Yellow	Yellow	Yellow
Approvals/Marks	CE	CE	CE - UL - CSA	CE - UL - CSA

Inductive proximity sensors, 3-wire, DC

Types

M8 Standard - Long body

Connections

2 m cable

M8 connector

M12 connector

Flush mountable



Dimensions (mm)	M8 x 45	M8 x 60	M12 x 70
Thread (mm)	M8 x 1 x 45	M8 x 1 x 40	M8 x 1 x 43
Operating frequency	2 kHz	2 kHz	2 kHz
Sensing distance (Sn)	1.5 mm	1.5 mm	1.5 mm

References

NPN-NO	IA08BLF15NO	IA08BLF15NOM5	IA08BLF15NOM1
PNP-NO	IA08BLF15PO	IA08BLF15POM5	IA08BLF15POM1
NPN-NC	IA08BLF15NC	IA08BLF15NCM5	IA08BLF15NCM1
PNP-NC	IA08BLF15PC	IA08BLF15PCM5	IA08BLF15PCM1

Non-flush mountable



Dimensions (mm)	M8 x 45	M8 x 60	M12 x 70
Thread (mm)	M8 x 1 x 42	M8 x 1 x 37	M8 x 1 x 40
Operating frequency	2 kHz	2 kHz	2 kHz
Sensing distance (Sn)	2.5 mm	2.5 mm	2.5 mm

References

NPN-NO	IA08BLN25NO	IA08BLN25NOM5	IA08BLN25NOM1
PNP-NO	IA08BLN25PO	IA08BLN25POM5	IA08BLN25POM1
NPN-NC	IA08BLN25NC	IA08BLN25NCM5	IA08BLN25NCM1
PNP-NC	IA08BLN25PC	IA08BLN25PCM5	IA08BLN25PCM1

Characteristics flush and non-flush mountable

Rated operating voltage	10 - 30 VDC	10 - 30 VDC	10 - 30 VDC
Voltage drop	≤ 2.5 VDC (@ I _{max})	≤ 2.5 VDC (@ I _{max})	≤ 2.5 VDC (@ I _{max})
Degree of protection	IP 67	IP 67	IP 67
Protection Short-circuit (S) Reverse polarity (P) Transients (T)	S	S	S
Output current	< 200 mA @ 25°C	< 200 mA @ 25°C	< 200 mA @ 25°C
Housing material	Stainless steel	Stainless steel	Stainless steel
Operating temperature	-25°C to +70°C	-25°C to +70°C	-25°C to +70°C
LED colour	Yellow	Yellow	Yellow
Approvals/Marks	CE - UL - CSA	CE - UL - CSA	CE - UL - CSA

Inductive proximity sensors, 3-wire, DC, extended range

Types M8 Extended - Short body

Connections 2 m cable M8 connector

Flush mountable

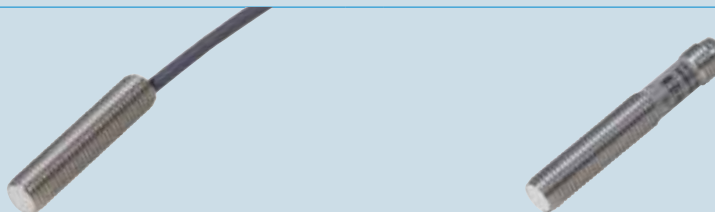

Dimensions (mm)	M8 x 35	M8 x 50
Thread (mm)	M8 x 1 x 35	M8 x 1 x 30
Operating frequency	2 kHz	2 kHz
Sensing distance (Sn)	2 mm	2 mm

References

NPN-NO	IA08BSF20NO	IA08BSF20NOM5
PNP-NO	IA08BSF20PO	IA08BSF20POM5
NPN-NC	IA08BSF20NC	IA08BSF20NCM5
PNP-NC	IA08BSF20PC	IA08BSF20PCM5

Non-flush mountable

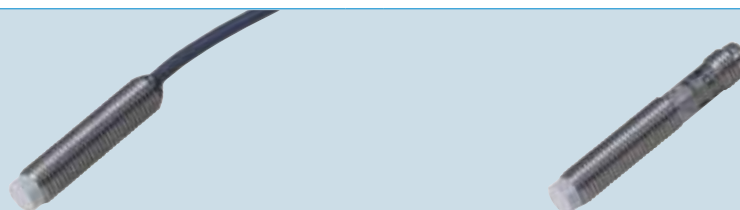

Dimensions (mm)	M8 x 35	M8 x 50
Thread (mm)	M8 x 1 x 32	M8 x 1 x 27
Operating frequency	1 kHz	1 kHz
Sensing distance (Sn)	4 mm	4 mm

References

NPN-NO	IA08BSN40NO	IA08BSN40NOM5
PNP-NO	IA08BSN40PO	IA08BSN40POM5
NPN-NC	IA08BSN40NC	IA08BSN40NCM5
PNP-NC	IA08BSN40PC	IA08BSN40PCM5

Characteristics flush and non-flush mountable

Rated operating voltage	10 - 30 VDC	10 - 30 VDC
Voltage drop	< 2.5 VDC @ 200 mA	< 2.5 VDC @ 200 mA
Degree of protection	IP 67	IP 67
Protection Short-circuit (S) Reverse polarity (P) Transients (T)	SPT	SPT
Output current	< 200 mA @ 25°C	< 200 mA @ 25°C
Housing material	Stainless steel	Stainless steel
Operating temperature	-25°C to +70°C	-25°C to +70°C
LED colour	Yellow	Yellow
Approvals/Marks	CE - UL - CSA	CE - UL - CSA

Inductive proximity sensors, high temperature

Types	M5	M8	M12	
Connections	2 m cable	2 m cable	2 m cable or M12 connector	
Flush or non-flush mountable				
Dimensions (mm)	M5 x 30	M8 x 45	M12 x 40	M12 x 40
Thread (mm)	M5 x 0.5 x 25	M8 x 1 x 40	M12 x 1 x 40	M12 x 1 x 34
Sensing distance (Sn)	0.8 mm	1 mm	2 mm	4 mm
Output	≤ 5 mA	≤ 5 mA	≤ 20 mA	≤ 20 mA
References				
NPN-NO Cable	IA05BSF08NOHT-K	IA08BSF10NOHT-K		
PNP-NO Cable	IA05BSF08POHT-K	IA08BSF10POHT-K	IA12ASF02POHT-K	IA12ASN04POHT-K
PNP-NO Plug			IA12ASF02POM1HT-K	IA12ASN04POM1HT-K
Specifications				
Rated operating voltage	10 - 30 VDC	10 - 30 VDC	10 - 30 VDC	10 - 30 VDC
Degree of protection	IP 67	IP 67	IP 67	IP 67
Protection Short-circuit (S)				
Reverse polarity (P)	SP	SP	S	S
Transients (T)				
Housing material	Stainless steel	Stainless steel	Nickel-plated brass	Nickel-plated brass
Operating temperature	-25°C to +120°C	-25°C to +120°C	-40°C to +100°C	-40°C to +100°C
Approvals/Marks	CE	CE	CE	CE

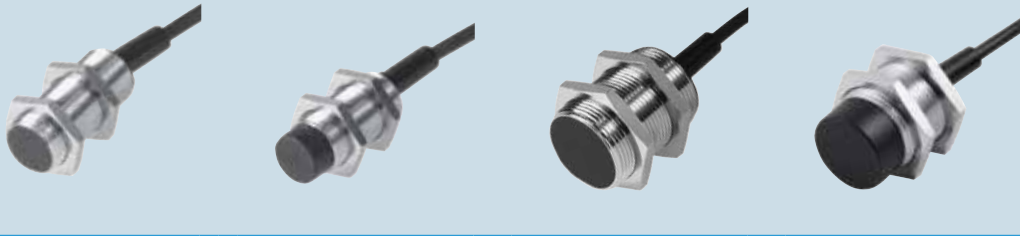
Types	M18		M30	
Connections	2 m cable or M12 connector		2 m cable or M12 connector	
Flush or non-flush mountable				
Dimensions (mm)	M18 x 40	M18 x 40	M30 x 40	M30 x 40
Thread (mm)	M18 x 1 x 40	M18 x 1 x 32	M30 x 1.5 x 40	M30 x 1.5 x 28
Sensing distance (Sn)	5 mm	8 mm	10 mm	15 mm
Output	≤ 25 mA	≤ 25 mA	≤ 25 mA	≤ 25 mA
References				
PNP-NO Cable	IA18ASF05POHT-K	IA18ASN08POHT-K	IA30ASF10POHT-K	IA30ASN15POHT-K
PNP-NO Plug	IA18ASF05POM1HT-K	IA18ASN08POM1HT-K	IA30ASF10POM1HT-K	IA30ASN15POM1HT-K
Characteristics flush and non-flush mountable				
Rated operating voltage	10 - 30 VDC	10 - 30 VDC	10 - 30 VDC	10 - 30 VDC
Degree of protection	IP 67	IP 67	IP 67	IP 67
Protection Short-circuit (S)				
Reverse polarity (P)	S	S	S	S
Transients (T)				
Housing material	Nickel-plated brass	Nickel-plated brass	Nickel-plated brass	Nickel-plated brass
Operating temperature	-40°C to +100°C	-40°C to +100°C	-40°C to +100°C	-40°C to +100°C
Approvals/Marks	CE	CE	CE	CE

Inductive proximity sensors, NAMUR, DC

Types	M12		M18	
Housing	Steel	Plastic	Steel	Plastic
Flush mountable				

Dimensions short body (mm)	Cable: M12 x 41 Plug (M12): M12 x 54.5	Cable: M12 x 41 Plug (M12): M12 x 54.5	Cable: M18 x 41.6 Plug (M12): M18 x 55	Cable: M18 x 41.6 Plug (M12): M18 x 55
Dimensions long body (mm)	Cable: M12 x 61 Plug (M12): M12 x 74.5	Cable: M12 x 61 Plug (M12): M12 x 74.5	Cable: M18 x 61.6 Plug (M12): M18 x 75	Cable: M18 x 61.6 Plug (M12): M18 x 75
Thread (mm)	Short: M12 x 1 x 30 Long: M12 x 1 x 50	Short: M12 x 1 x 30 Long: M12 x 1 x 50	Short: M18 x 1 x 30 Long: M18 x 1 x 50	Short: M18 x 1 x 30 Long: M18 x 1 x 50
Operating frequency	1.4 kHz	1.4 kHz	500 Hz	500 Hz
Sensing distance (Sn)	2 mm	2 mm	5 mm	5 mm

References				
Short body cable	IA12ESF02UC	IA12CSF02UC	IA18ESF05UC	IA18CSF05UC
Long body cable	IA12ELF02UC	IA12CLF02UC	IA18ELF05UC	IA18CLF05UC
Short body plug	IA12ESF02UCM1	IA12CSF02UCM1	IA18ESF05UCM1	IA18CSF05UCM1
Long body plug	IA12ELF02UCM1	IA12CLF02UCM1	IA18ELF05UCM1	IA18CLF05UCM1

Non-flush mountable				
----------------------------	---	---	---	---

Dimensions short body (mm)	Cable: M12 x 45 Plug (M12): M12 x 58.5	Cable: M12 x 45 Plug (M12): M12 x 58.5	Cable: M18 x 49.6 Plug (M12): M18 x 63	Cable: M18 x 49.6 Plug (M12): M18 x 63
Dimensions long body (mm)	Cable: M12 x 65 Plug (M12): M12 x 78.5	Cable: M12 x 65 Plug (M12): M12 x 78.5	Cable: M18 x 69.6 Plug (M12): M18 x 83	Cable: M18 x 69.6 Plug (M12): M18 x 83
Thread (mm)	Short: M12 x 1 x 30 Long: M12 x 1 x 50	Short: M12 x 1 x 30 Long: M12 x 1 x 50	Short: M18 x 1 x 30 Long: M18 x 1 x 50	Short: M18 x 1 x 30 Long: M18 x 1 x 50
Operating frequency	1.2 kHz	1.2 kHz	200 Hz	200 Hz
Sensing distance (Sn)	4 mm	4 mm	8 mm	8 mm

References				
Short body cable	IA12ESN04UC	IA12CSN04UC	IA18ESN08UC	IA18CSN08UC
Long body cable	IA12ELN04UC	IA12CLN04UC	IA18ELN08UC	IA18CLN08UC
Short body plug	IA12ESN04UCM1	IA12CSN04UCM1	IA18ESN08UCM1	IA18CSN08UCM1
Long body plug	IA12ELN04UCM1	IA12CLN04UCM1	IA18ELN08UCM1	IA18CLN08UCM1

Characteristics flush and non-flush mountable				
Rated operating voltage	7 - 9 VDC	7 - 9 VDC	7 - 9 VDC	7 - 9 VDC
Degree of protection	IP 67	IP 67	IP 67	IP 67
Housing material	Stainless steel	Thermoplastic polyester	Stainless steel	Thermoplastic polyester
Operating temperature	-25°C to +70°C	-25°C to +70°C	-25°C to +70°C	-25°C to +70°C
LED colour	Yellow	Yellow	Yellow	Yellow
Approvals/Marks	CE - UL - CSA	CE - UL - CSA	CE - UL - CSA	CE - UL - CSA

Inductive proximity sensors, NAMUR, DC

Types

M30

Housing

Steel

Plastic

Flush mountable



Dimensions short body (mm)	Cable: M30 x 43.6 Plug (M12): M30 x 55.5	Cable: M30 x 43.6 Plug (M12): M30 x 55.5
Dimensions long body (mm)	Cable: M30 x 63.6 Plug (M12): M30 x 75.5	Cable: M30 x 63.6 Plug (M12): M30 x 75.5
Thread (mm)	Short: M30 x 1.5 x 30 Long: M30 x 1.5 x 50	Short: M30 x 1.5 x 30 Long: M30 x 1.5 x 50
Operating frequency	300 Hz	300 Hz
Sensing distance (Sn)	10 mm	10 mm

References

Short body cable	IA30ESF10UC	IA30CSF10UC
Long body cable	IA30ELF10UC	IA30CLF10UC
Short body plug	IA30ESF10UCM1	IA30CSF10UCM1
Long body plug	IA30ELF10UCM1	IA30CLF10UCM1

Non-flush mountable



Dimensions short body (mm)	Cable: M30 x 55.6 Plug (M12): M30 x 67.5	Cable: M30 x 55.6 Plug (M12): M30 x 67.5
Dimensions long body (mm)	Cable: M30 x 75.6 Plug (M12): M30 x 87.5	Cable: M30 x 75.6 Plug (M12): M30 x 87.5
Thread (mm)	Short: M30 x 1.5 x 30 Long: M30 x 1.5 x 50	Short: M30 x 1.5 x 30 Long: M30 x 1.5 x 50
Operating frequency	100 Hz	100 Hz
Sensing distance (Sn)	15 mm	15 mm



References



Short body cable	IA30ESN15UC	IA30CSN15UC
Long body cable	IA30ELN15UC	IA30CLN15UC
Short body plug	IA30ESN15UCM1	IA30CSN15UCM1
Long body plug	IA30ELN15UCM1	IA30CLN15UCM1

Characteristics flush and non-flush mountable

Rated operating voltage	7 - 9 VDC	7 - 9 VDC
Degree of protection	IP 67	IP 67
Housing material	Stainless steel	Thermoplastic polyester
Operating temperature	-25°C to +70°C	-25°C to +70°C
LED colour	Yellow	Yellow
Approvals/Marks	CE - UL - CSA	CE - UL - CSA

Inductive proximity sensors, 2-wire, DC, extended range

Types	M8 Extended Short body	M12 Extended - Short body	
Connections	2 m cable	2 m cable	M12 connector
Flush mountable			
Dimensions (mm)	M8 x 30	M12 x 49	M12 x 63
Thread (mm)	M8 x 1 x 30	M12 x 1 x 38	M12 x 1 x 38
Operating frequency	2 kHz	1 kHz	1 kHz
Sensing distance (Sn)	2 mm	4 mm	4 mm
References			
NO	IA08BSF02DO	IA12DSF04DO	IA12ASF04DOM1
NC	IA08BSF02DC	IA12DSF04DC	IA12ASF04DCM1

Non-flush mountable			
Dimensions (mm)	M8 x 30	M12 x 53	M12 x 67
Thread (mm)	M8 x 1 x 26	M12 x 1 x 38	M12 x 1 x 38
Operating frequency	2 kHz	800 Hz	800 Hz
Sensing distance (Sn)	4 mm	8 mm	8 mm
References			
NO	IA08BSN04DO	IA12DSN08DO	IA12ASN08DOM1
NC	IA08BSN04DC	IA12DSN08DC	IA12ASN08DCM1

Characteristics flush and non-flush mountable			
Rated operating voltage	10 - 30 VDC	10 - 40 VDC	10 - 40 VDC
Voltage drop	≤ 8 VDC @ max. load	≤ 3 VDC @ max. load	≤ 3 VDC @ max. load
Degree of protection	IP 67	IP 67	IP 67
Protection Short-circuit (S) Reverse polarity (P) Transients (T)	SPT	SPT	SPT
Output current	3 - 100 mA	5 - 100 mA	5 - 100 mA
Housing material	Stainless steel	Nickel-plated brass	Nickel-plated brass
Operating temperature	-25°C to +70°C	-25°C to +70°C	-25°C to +70°C
LED colour	Yellow	Yellow	Yellow
Approvals/Marks	CE - CSA	CE - UL - CSA	CE - UL - CSA

Inductive proximity sensors, 2-wire, DC, extended range

Types	M18 Extended - Short body		M30 Extended - Short body	
Connections	2 m cable	M12 connector	2 m cable	M12 connector
Flush mountable				
Dimensions (mm)	M18 x 42	M18 x 55	M30 x 44	M30 x 55
Thread (mm)	M18 x 1 x 30	M18 x 1 x 30	M30 x 1.5 x 30	M30 x 1.5 x 30
Operating frequency	500 Hz	500 Hz	400 Hz	400 Hz
Sensing distance (Sn)	8 mm	8 mm	15 mm	15 mm
References				
NO	IA18DSF08DO	IA18ASF08DOM1	IA30DSF15DO	IA30ASF15DOM1
NC	IA18DSF08DC	IA18ASF08DCM1	IA30DSF15DC	IA30ASF15DCM1
Non-flush mountable				
Dimensions (mm)	M18 x 50	M18 x 63	M30 x 56	M30 x 67
Thread (mm)	M18 x 1 x 30	M18 x 1 x 30	M30 x 1.5 x 30	M30 x 1.5 x 30
Operating frequency	400 Hz	400 Hz	200 Hz	200 Hz
Sensing distance (Sn)	14 mm	14 mm	22 mm	22 mm
References				
NO	IA18DSN14DO	IA18ASN14DOM1	IA30DSN22DO	IA30ASN22DOM1
NC	IA18DSN14DC	IA18ASN14DCM1	IA30DSN22DC	IA30ASN22DCM1
Characteristics flush and non-flush mountable				
Rated operating voltage	10 - 40 VDC	10 - 40 VDC	10 - 40 VDC	10 - 40 VDC
Voltage drop	≤ 3 VDC @ max. load	≤ 3 VDC @ max. load	≤ 3 VDC @ max. load	≤ 3 VDC @ max. load
Degree of protection	IP 67	IP 67	IP 67	IP 67
Protection Short-circuit (S) Reverse polarity (P) Transients (T)	SPT	SPT	SPT	SPT
Output current	5 - 100 mA	5 - 100 mA	5 - 100 mA	5 - 100 mA
Housing material	Nickel-plated brass	Nickel-plated brass	Nickel-plated brass	Nickel-plated brass
Operating temperature	-25°C to +70°C	-25°C to +70°C	-25°C to +70°C	-25°C to +70°C
LED colour	Yellow	Yellow	Yellow	Yellow
Approvals/Marks	CE - UL - CSA	CE - UL - CSA	CE - UL - CSA	CE - UL - CSA

Inductive proximity sensors, 2-wire, AC

Types M12 Standard - Long body

Connections 2 m cable M12 connector



Dimensions (mm)	M12 x 66	M12 x 74.5
Thread (mm)	M12 x 1 x 50	M12 x 1 x 50
Operating frequency	25 Hz	25 Hz
Sensing distance (Sn)	2 mm	2 mm

References

SCR-NO	EI1202TBOSL	EI1202TBOSL-6
SCR-NC	EI1202TBCSL	

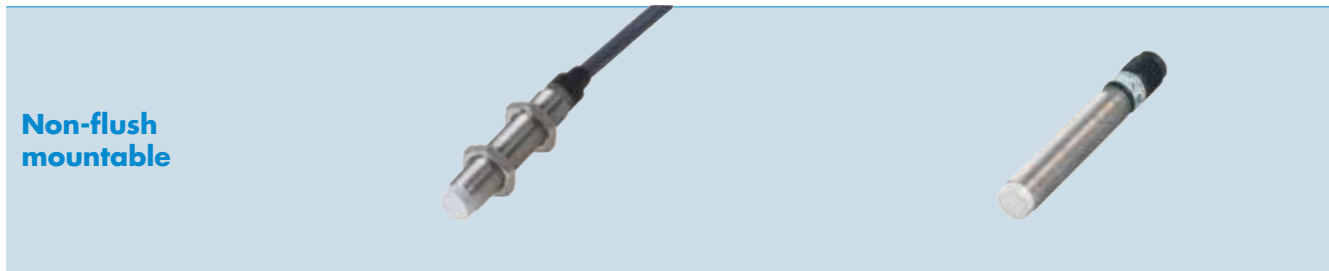

Dimensions (mm)	M12 x 70	M12 x 78.5
Thread (mm)	M12 x 1 x 50	M12 x 1 x 50
Operating frequency	25 Hz	25 Hz
Sensing distance (Sn)	4 mm	4 mm

References

SCR-NO	EI1204TBOSL	EI1204TBOSL-6
SCR-NC	EI1204TBCSL	

Characteristics flush and non-flush mountable

Rated operating voltage	20 - 265 VAC	20 - 265 VAC
Voltage drop	≤ 8 VAC	≤ 8 VAC
Degree of protection	IP 67	IP 67
Protection Short-circuit (S)		
Reverse polarity (P)	T	T
Transients (T)		
Output current	< 500 mA	< 500 mA
Housing material	Stainless steel	Stainless steel
Operating temperature	-25°C to +70°C	-25°C to +70°C
LED colour	Yellow	Yellow
Approvals/Marks	CE - UL - CSA	CE - UL - CSA

Inductive proximity sensors, 2-wire, AC

Types	M18 Standard - Short body		M18 Standard - Long body	
Connections	2 m cable	M12 connector	2 m cable	M12 connector

Flush mountable



Dimensions (mm)	M18 x 57	M18 x 55	M18 x 77	M18 x 75
Thread (mm)	M18 x 1 x 30	M18 x 1 x 30	M18 x 1 x 50	M18 x 1 x 50
Operating frequency	25 Hz	25 Hz	25 Hz	25 Hz
Sensing distance (Sn)	5 mm	5 mm	5 mm	5 mm

References

SCR-NO	EI1805TBOSS	EI1805TBOSS-6	EI1805TBOSL	EI1805TBOSL-6
SCR-NC	EI1805TBCSS		EI1805TBCSL	

Non-flush mountable



Dimensions (mm)	M18 x 65	M18 x 63	M18 x 85	M18 x 83
Thread (mm)	M18 x 1 x 30	M18 x 1 x 30	M18 x 1 x 50	M18 x 1 x 50
Operating frequency	25 Hz	25 Hz	25 Hz	25 Hz
Sensing distance (Sn)	8 mm	8 mm	8 mm	8 mm

References

SCR-NO	EI1808TBOSS	EI1808TBOSS-6	EI1808TBOSL	EI1808TBOSL-6
SCR-NC	EI1808TBCSS		EI1808TBCSL	EI1808TBCSL-6

Characteristics flush and non-flush mountable

Rated operating voltage	20 - 265 VAC	20 - 265 VAC	20 - 265 VAC	20 - 265 VAC
Voltage drop	≤ 8 VAC	≤ 8 VAC	≤ 8 VAC	≤ 8 VAC
Degree of protection	IP 67	IP 67	IP 67	IP 67
Protection Short-circuit (S) Reverse polarity (P) Transients (T)	T	T	T	T
Output current	< 500 mA	< 500 mA	< 500 mA	< 500 mA
Housing material	Stainless steel	Stainless steel	Stainless steel	Stainless steel
Operating temperature	-25°C to +70°C	-25°C to +70°C	-25°C to +70°C	-25°C to +70°C
LED colour	Yellow	Yellow	Yellow	Yellow
Approvals/Marks	CE - UL - CSA	CE - UL - CSA	CE - UL - CSA	CE - UL - CSA

Inductive proximity sensors, 2-wire, AC

Types	M30 Standard - Short body		M30 Standard - Long body	
Connections	2 m cable	M12 connector	2 m cable	M12 connector

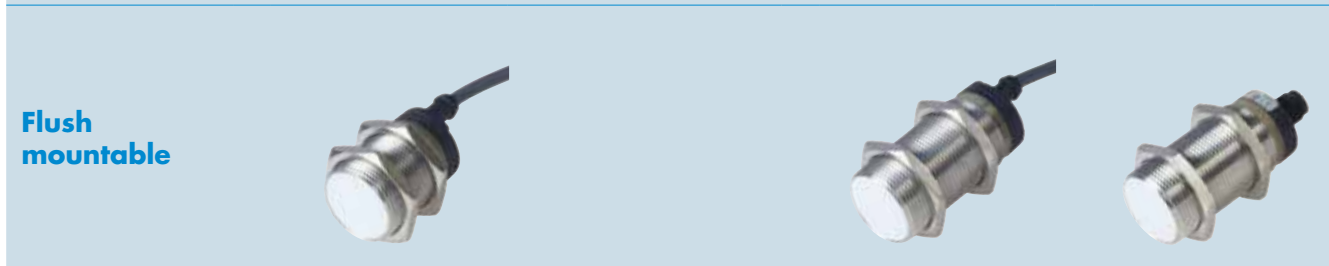

Dimensions (mm)	M30 x 59		M30 x 79	M30 x 75.5
Thread (mm)	M30 x 1.5 x 30		M30 x 1.5 x 50	M30 x 1.5 x 50
Operating frequency	25 Hz		25 Hz	25 Hz
Sensing distance (Sn)	10 mm		10 mm	10 mm

References

SCR-NO	EI3010TBOSS		EI3010TBOSL	EI3010TBOSL-6
SCR-NC	EI3010TBCSS		EI3010TBCSL	



Dimensions (mm)	M30 x 87.5	M30 x 67.5	M30 x 91	M30 x 71
Thread (mm)	M30 x 1.5 x 30	M30 x 1.5 x 30	M30 x 1.5 x 50	M30 x 1.5 x 50
Operating frequency	25 Hz	25 Hz	25 Hz	25 Hz
Sensing distance (Sn)	15 mm	15 mm	15 mm	15 mm







References

SCR-NO	EI3015TBOSS	EI3015TBOSS-6	EI3015TBOSL	EI3015TBOSL-6
SCR-NC	EI3015TBCSS		EI3015TBCSL	

Characteristics flush and non-flush mountable

Rated operating voltage	20 - 265 VAC	20 - 265 VAC	20 - 265 VAC	20 - 265 VAC
Voltage drop	≤ 8 VAC	≤ 8 VAC	≤ 8 VAC	≤ 8 VAC
Degree of protection	IP 67	IP 67	IP 67	IP 67
Protection Short-circuit (S)				
Reverse polarity (P)	T	T	T	T
Transients (T)				
Output current	< 500 mA	< 500 mA	< 500 mA	< 500 mA
Housing material	Stainless steel	Stainless steel	Stainless steel	Stainless steel
Operating temperature	-25°C to +70°C	-25°C to +70°C	-25°C to +70°C	-25°C to +70°C
LED colour	Yellow	Yellow	Yellow	Yellow
Approvals/Marks	CE - UL - CSA	CE - UL - CSA	CE - UL - CSA	CE - UL - CSA

Inductive proximity sensors, 2-wire, AC

Types	M18 Standard Short body	M18 Standard - Long body		M30 Standard Long body
Connections	2 m cable	2 m cable	M12 connector	2 m cable
Flush mountable				
Dimensions (mm)	M18 x 57	M18 x 77		M30 x 79
Thread (mm)	M18 x 1 x 30	M18 x 1 x 50		M30 x 1.5 x 50
Operating frequency	25 Hz	25 Hz		25 Hz
Sensing distance (Sn)	5 mm	5 mm		10 mm
References				
SCR-NO	EI1805TBOPS	EI1805TBOPL		EI3010TBOPL
Non-flush mountable				
Dimensions (mm)		M18 x 85	M18 x 83	M30 x 91
Thread (mm)		M18 x 1 x 50	M18 x 1 x 50	M30 x 1.5 x 50
Operating frequency		25 Hz	25 Hz	25 Hz
Sensing distance (Sn)		8 mm	8 mm	15 mm
References				
SCR-NO		EI1808TBOPL		EI3015TBOPL
SCR-NC		EI1808TBCPL	EI1808TBCPL-6	
Characteristics flush and non-flush mountable				
Rated operating voltage	20 - 265 VAC	20 - 265 VAC	20 - 265 VAC	20 - 265 VAC
Voltage drop	≤ 8 VAC	≤ 8 VAC	≤ 8 VAC	≤ 8 VAC
Degree of protection	IP 67	IP 67	IP 67	IP 67
Protection Short-circuit (S)				
Reverse polarity (P)	T	T	T	T
Transients (T)				
Output current	< 500 mA	< 500 mA	< 500 mA	< 500 mA
Housing material	Thermoplastic polyester	Thermoplastic polyester	Thermoplastic polyester	Thermoplastic polyester
Operating temperature	-25°C to +70°C	-25°C to +70°C	-25°C to +70°C	-25°C to +70°C
LED colour	Yellow	Yellow	Yellow	Yellow
Approvals/Marks	CE - UL - CSA	CE - UL - CSA	CE - UL - CSA	CE - UL - CSA

Inductive proximity sensors, micro switch 2-wire DC

Types Micro switch

Connections 2 m cable



Dimensions body (mm) 30 x 19 x 15

Thread (mm) Ø 12 x 16

Sensing distance (Sn) 1 kHz

Output 4 mm

References

NO IG12FSF04DO

NC IG12FSF04DC

Specifications

Rated operating voltage 10 to 40 VDC

Voltage drop ≤ 3 VDC at max. load

Degree of protection IP67

**Protection Short-circuit (S)
Reverse polarity (P)
Transients (T)** SPT



Output current ≤ 5 - 100 mA

Housing material Anodized aluminium



Operating temperature -25°C to +70°C

Approvals/Marks CE

Inductive proximity sensors, switch, polyester housing

Types	Transistor NPN/PNP		Power MOSFET output AC/DC	
Connections	Terminals		Terminals	Terminals
Non-flush mountable				
Dimensions (mm)	40 x 40 x 118		40 x 40 x 118	40 x 40 x 118
Operating frequency	≤ 100 Hz		≤ 25 Hz AC; 40 Hz DC	≤ 25 Hz
Sensing distance (Sn)	30 mm		30 mm	30 mm
References				
NPN - NO / NC	IC40CNN30NAT1			
PNP - NO / NC	IC40CNN30PAT1			
AC / DC - NO			IC40CNN30COT1	
AC / DC - NC			IC40CNN30CCT1	
AC - NO / NC				IC40CNN30TAT1
Specifications				
Rated operating voltage	10 - 30 VDC		20 - 250 VAC/DC	20 - 250 VAC
Degree of protection	IP 67		IP 67	IP 67
Protection Short-circuit (S) Reverse polarity (P) Transients (T)	SP		S	
Output current	≤ 200 mA		5 - 200 mA @ 25°C	5 - 200 mA @ 25°C
Housing material	Thermoplastic polyester		Thermoplastic polyester	Thermoplastic polyester
Operating temperature	-25°C to +70°C		-25°C to +70°C	-25°C to +70°C
LED colour	Red, green		Red, green	Red, green
Approvals/Marks	CE		CE	CE

Inductive proximity sensors, loop detector

Types	Single loop	Dual loop
Connections	Plug 11 pin circular	Plug 11 pin circular
		
Dimensions HxWxD (mm)	80 x 35.5 x 63	80 x 35.5 x 63
Adjustment	Auto	Auto
Manual fine-tune	Yes	Yes
Loop inductance	15-1500 µH	15-1500 µH
Input	1 Loop	2 Loop
Output	1 x SPDT, 1 A / 250 VAC	2 x SPST, 1 A / 250 VAC
References		
24 VAC / DC	LDP1SA1BM24	LDP2TA2BM24
115 VAC	LDP1SA1B115	LDP2TA2B115
230 VAC	LDP1SA1B230	LDP2TA2B230
Specifications		
Operating temperature	-20°C to +70°C	-20°C to +70°C
Degree of protection	IP20	IP20
Mounting	11 pin circular plug	11 pin circular plug
Approvals/Marks	CE - UL	CE - UL

Capacitive proximity sensors, TRIPLESIELD™

Types

M18-AC TRIPLESIELD™

Connections

2 m cable

M12 connector

Flush mountable



Dimensions (mm)

M18 x 71.5

M18 x 83.5

Thread (mm)

M18 x 1 x 46.5

M18 x 1 x 46.5

Operating frequency

10 Hz

10 Hz

Sensing distance (Sn)

3 - 8 mm (adjustable)

3 - 8 mm (adjustable)

References

NPN - NO and NC

PNP - NO and NC

Thyristor (SCR) NO

CA18CLF08TO

CA18CLF08TOM6

Thyristor (SCR) NC

CA18CLF08TC

CA18CLF08TCM6

Non-flush mountable

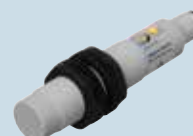

Dimensions (mm)

M18 x 79.5

M18 x 91.5

Thread (mm)

M18 x 1 x 46.5

M18 x 1 x 46.5

Operating frequency

10 Hz

10 Hz

Sensing distance (Sn)

3 - 12 mm (adjustable)

3 - 12 mm (adjustable)

References

NPN - NO and NC

PNP - NO and NC

Thyristor (SCR) NO

CA18CLN12TO

CA18CLN12TOM6

Thyristor (SCR) NC

CA18CLN12TC

CA18CLN12TCM6

Characteristics flush and non-flush mountable

Rated operating voltage

20 - 250 VAC

20 - 250 VAC

Voltage drop

≤ 10 VAC

≤ 10 VAC

Degree of protection

IP 67

IP 67

Protection Short-circuit (S)
Reverse polarity (P)
Transients (T)

T

T

Output current

< 500 mA

< 500 mA

Housing material

Thermoplastic polyester

Thermoplastic polyester

Operating temperature

-25°C to +80°C

-25°C to +80°C

LED colour

Yellow

Yellow

Approvals/Marks

CE - UL - CSA

CE - UL - CSA

Capacitive proximity sensors, 4th Generation TRIPLESIELD™

Types	M18-DC 4 th Generation TRIPLESIELD™ Flush mountable		M18-DC 4 th Generation TRIPLESIELD™ Non-flush mountable	
Connections	2 m cable	M12 connector	2 m cable	M12 connector
				
Dimensions (mm)	M18 x 70	M18 x 85	M18 x 70	M18 x 85
Thread (mm)	M18 x 1.0 x 55	M18 x 1.0 x 55	M18 x 1.0 x 55	M18 x 1.0 x 55
Operating frequency	50 Hz	50 Hz	50 Hz	50 Hz
Sensing distance (Sn)	2 - 10 mm (adjustable)	2 - 10 mm (adjustable)	3 - 15 mm (adjustable)	3 - 15 mm (adjustable)
References				
Standard				
NPN - NO and NC	CA18CAF08NA	CA18CAF08NAM1	CA18CAN12NA	CA18CAN12NAM1
PNP - NO and NC	CA18CAF08PA	CA18CAF08PAM1	CA18CAN12PA	CA18CAN12PAM1
Dust alarm				
PNP - NO	CA18CAF08PODU		CA18CAN12PODU	
PNP - NC	CA18CAF08PCDU		CA30CN25PCDU	
Temperature alarm				
PNP - NO	CA18CAF08POTA		CA18CAN12POTA	
PNP - NC	CA18CAF08PCTA		CA18CAN12PCTA	
Characteristics flush and non-flush mountable				
Rated operating voltage	10 - 40 VDC	10 - 40 VDC	10 - 40 VDC	10 - 40 VDC
Voltage drop	≤ 2.0 VDC	≤ 2.0 VDC	≤ 2.0 VDC	≤ 2.0 VDC
Degree of protection	IP 67, IP 68, IP 69K	IP 67, IP 68, IP 69K	IP 67, IP 68, IP 69K	IP 67, IP 68, IP 69K
Protection Short-circuit (S) Reverse polarity (P) Transients (T)	SPT	SPT	SPT	SPT
Output current	< 200 mA	< 200 mA	< 200 mA	< 200 mA
Housing material	PBT	PBT	PBT	PBT
Operating temperature	-30°C to +85°C	-30°C to +85°C	-30°C to +85°C	-30°C to +85°C
LED colour	Yellow and Green	Yellow and Green	Yellow and Green	Yellow and Green
Approvals/Marks	CE - cULus - ECOLAB	CE - cULus - ECOLAB	CE - cULus - ECOLAB	CE - cULus - ECOLAB

Capacitive proximity sensors, TRIPLESIELD™

Types

M30-DC TRIPLESIELD™

Connections

2 m cable

M12 connector

Flush mountable



Dimensions (mm)

M30 x 63.6

M30 x 63.6

Thread (mm)

M30 x 1.5 x 50

M30 x 1.5 x 50

Operating frequency

50 Hz

50 Hz

Sensing distance (Sn)

2 - 16 mm (adjustable)

2 - 16 mm (adjustable)

References

NPN - NO and NC

EC3016NPASL

EC3016NPASL-1

PNP - NO and NC

EC3016PPASL

EC3016PPASL-1

Non-flush mountable



Dimensions (mm)

M30 x 75.6

M30 x 75.6

Thread (mm)

M30 x 1.5 x 50

M30 x 1.5 x 50

Operating frequency

50 Hz

50 Hz

Sensing distance (Sn)

4 - 25 mm (adjustable)

4 - 25 mm (adjustable)

References

NPN - NO and NC

EC3025NPASL

EC3025NPASL-1

PNP - NO and NC

EC3025PPASL

EC3025PPASL-1

Characteristics flush and non-flush mountable

Rated operating voltage

10 - 40 VDC

10 - 40 VDC

Voltage drop

≤ 2.5 VDC

≤ 2.5 VDC

Degree of protection

IP 67

IP 67

Protection Short-circuit (S)
Reverse polarity (P)
Transients (T)

SPT

SPT

Output current

< 200 mA

< 200 mA

Housing material

Stainless steel

Stainless steel

Operating temperature

-25°C to +80°C

-25°C to +80°C

LED colour

Yellow

Yellow

Approvals/Marks

CE - UL - CSA

CE - UL - CSA

Capacitive proximity sensors, 4th Generation TRIPLESIELD™

M30-DC 4th Generation TRIPLESIELD™

Types	Flush mountable		Non-flush mountable	
	2 m cable	M12 connector	2 m cable	M12 connector



Dimensions (mm)	M30 x 81	M30 x 74	M30 x 81	M30 x 74
Thread (mm)	M30 x 1.5 x 59.5	M30 x 1.5 x 59.5	M30 x 1.5 x 45.5	M30 x 1.5 x 45.5
Operating frequency	50 Hz	50 Hz	50 Hz	50 Hz
Sensing distance (S _n)	2 - 20 mm (adjustable)	2 - 20 mm (adjustable)	4 - 30 mm (adjustable)	4 - 30 mm (adjustable)

References

Standard				
NPN - NO and NC	CA30CAF16NA	CA30CAF16NAM1	CA30CAN25NA	CA30CAN25NAM1
PNP - NO and NC	CA30CAF16PA	CA30CAF16PAM1	CA30CAN25PA	CA30CAN25PAM1
Dust alarm				
PNP - NO	CA30CAF16PODU		CA30CAN25PODU	
PNP - NC	CA30CAF16PCDU		CA30CAN25PCDU	
Temperature alarm				
PNP - NO	CA30CAF16POTA		CA30CAN25POTA	
PNP - NC	CA30CAF16PCTA		CA30CAN25PCTA	

Characteristics flush and non-flush mountable

Rated operating voltage	10 - 40 VDC	10 - 40 VDC	10 - 40 VDC	10 - 40 VDC
Voltage drop	≤ 2.0 VDC	≤ 2.0 VDC	≤ 2.0 VDC	≤ 2.0 VDC
Degree of protection	IP 67, IP 68, IP 69K	IP 67, IP 68, IP 69K	IP 67, IP 68, IP 69K	IP 67, IP 68, IP 69K
Protection Short-circuit (S) Reverse polarity (P) Transients (T)	SPT	SPT	SPT	SPT
Output current	< 200 mA	< 200 mA	< 200 mA	< 200 mA
Housing material	PBT	PBT	PBT	PBT
Operating temperature	-30°C to +85°C	-30°C to +85°C	-30°C to +85°C	-30°C to +85°C
LED colour	Yellow and Green	Yellow and Green	Yellow and Green	Yellow and Green
Approvals/Marks	CE - cULus - ECOLAB	CE - cULus - ECOLAB	CE - cULus - ECOLAB	CE - cULus - ECOLAB

Capacitive proximity sensors, TRIPLESIELD™

Types

M30-AC TRIPLESIELD™

Connections 2 m cable M12 connector 2 m cable M12 connector

Flush mountable



Dimensions (mm)	M30 x 63.6	M30 x 63.6	M30 x 63.6	M30 x 63.6
Thread (mm)	M30 x 1.5 x 50	M30 x 1.5 x 50	M30 x 1.5 x 50	M30 x 1.5 x 50
Operating frequency	10 Hz	10 Hz	10 Hz	10 Hz
Sensing distance (Sn)	2 - 16 mm (adjustable)	2 - 16 mm (adjustable)	2 - 16 mm (adjustable)	2 - 16 mm (adjustable)

References

Thyristor (SCR) NO or NC	EC3016TBAPL	EC3016TBAPL-6	EC3016TBASL	EC3016TBASL-6
--------------------------	-------------	---------------	-------------	---------------

Non-flush mountable



Dimensions (mm)	M30 x 75.6	M30 x 75.6	M30 x 75.6	M30 x 75.6
Thread (mm)	M30 x 1.5 x 50	M30 x 1.5 x 50	M30 x 1.5 x 50	M30 x 1.5 x 50
Operating frequency	10 Hz	10 Hz	10 Hz	10 Hz
Sensing distance (Sn)	4 - 25 mm (adjustable)	4 - 25 mm (adjustable)	4 - 25 mm (adjustable)	4 - 25 mm (adjustable)

References

Thyristor (SCR) NO or NC	EC3025TBAPL	EC3025TBAPL-6	EC3025TBASL	EC3025TBASL-6
--------------------------	-------------	---------------	-------------	---------------

Characteristics flush and non-flush mountable

Rated operating voltage	20 - 250 VAC	20 - 250 VAC	20 - 250 VAC	20 - 250 VAC
Voltage drop	< 10 VAC	< 10 VAC	< 10 VAC	< 10 VAC
Degree of protection	IP 67	IP 67	IP 67	IP 67
Protection Short-circuit (S)				
Reverse polarity (P)	T	T	T	T
Transients (T)				
Output current	< 500 mA	< 500 mA	< 500 mA	< 500 mA
Housing material	Thermoplastic polyester	Thermoplastic polyester	Stainless steel	Stainless steel
Operating temperature	-25°C to +80°C	-25°C to +80°C	-25°C to +80°C	-25°C to +80°C
LED colour	Yellow	Yellow	Yellow	Yellow
Approvals/Marks	CE - UL - CSA	CE - UL - CSA	CE - UL - CSA	CE - UL - CSA

Capacitive proximity sensors, TRIPLESIELD™

Types	M12 teach-in TRIPLESIELD™		M18 teach-in TRIPLESIELD™	
Connections	2 m cable	M12 connector	2 m cable	M12 connector
Flush mountable				
Dimensions (mm)	M12 x 82.4	M12 x 84.7	M18 x 89.55	M18 x 89.2
Thread (mm)	M12 x 1 x 50	M12 x 1 x 50	M18 x 1 x 50	M18 x 1 x 50
Operating frequency	15 Hz	15 Hz	15 Hz	15 Hz
Sensing distance (Sn)	0.5 - 8 mm (Teach-in)	0.5 - 8 mm (Teach-in)	0.2 - 12 mm (Teach-in)	0.2 - 12 mm (Teach-in)
References				
NPN/PNP, NO/NC	CA12CLC08BP	CA12CLC08BPM1	CA18CLC12BP	CA18CLC12BPM1
Characteristics flush and non-flush mountable				
Rated operating voltage	10 - 40 VDC	10 - 40 VDC	10 - 40 VDC	10 - 40 VDC
Voltage drop	< 2.5 VDC	< 2.5 VDC	< 2.5 VDC	< 2.5 VDC
Degree of protection	IP 68	IP 68	IP 68	IP 68
Protection Short-circuit (S) Reverse polarity (P) Transients (T)	SPT	SPT	SPT	SPT
Output current	< 250 mA	< 250 mA	< 250 mA	< 250 mA
Housing material	Thermoplastic polyester	Thermoplastic polyester	Thermoplastic polyester	Thermoplastic polyester
Operating temperature	-25°C to +85°C	-25°C to +85°C	-25°C to +85°C	-25°C to +85°C
Special features	Teach-in, humidity compensation NPN/PNP auto detection, remote setup, alarm output. On request: dirt and moisture compensation	Teach-in, humidity compensation NPN/PNP auto detection, remote setup, alarm output. On request: dirt and moisture compensation	Teach-in, humidity compensation NPN/PNP auto detection, remote setup, alarm output. On request: dirt and moisture compensation	Teach-in, humidity compensation NPN/PNP auto detection, remote setup, alarm output. On request: dirt and moisture compensation
Approvals/Marks	CE - UL - CSA	CE - UL - CSA	CE - UL - CSA	CE - UL - CSA

Capacitive proximity sensors, TRIPLESIELD™

Types	M30 teach in TRIPLESIELD™		M30 AC/DC TRIPLESIELD™	
Connections	2 m cable	M12 connector	2 m cable	M12 connector

Flush mountable



Dimensions (mm)	M30 x 99.2	M30 x 90.45	M30 x 63.6	M30 x 75.6
Thread (mm)	M30 x 1.5 x 50	M30 x 1.5 x 50	M30 x 1.5 x 50	M30 x 1.5 x 50
Operating frequency	15 Hz	15 Hz	10 Hz	10 Hz
Sensing distance (Sn)	0.5 - 30 mm (adjustable)	0.5 - 30 mm (adjustable)	2 - 16 mm (adjustable)	2 - 16 mm (adjustable)

References

NPN/PNP, NO/NC	CA30CLC30BP	CA30CLC30BPM1		
Power MOFSET			CA30CLF16CP	CA30CLF16CPM6

Non-flush mountable



Dimensions (mm)			M30 x 71.6	M30 x 83.6
Thread (mm)			M30 x 1.5 x 50	M30 x 1.5 x 50
Operating frequency			10 Hz	10 Hz
Sensing distance (Sn)			2 - 25 mm (adjustable)	2 - 25 mm (adjustable)

References

Power MOFSET			CA30CLN25CP	CA30CLN25CPM6
--------------	--	--	-------------	---------------

Characteristics flush and non-flush mountable

Rated operating voltage	10 - 40 VDC	10 - 40 VDC	20 - 250 VAC/DC	20 - 250 VAC/DC
Voltage drop	< 2.5 VDC	< 2.5 VDC	< 5.5 VAC/DC	< 5.5 VAC/DC
Degree of protection	IP 68	IP 68	IP 67	IP 67
Protection Short-circuit (S)				
Reverse polarity (P)	SPT	SPT	PT	PT
Transients (T)				
Output current	< 250 mA	< 250 mA	< 250 mA DC < 350 mA AC	< 250 mA DC < 350 mA AC
Housing material	Thermoplastic polyester	Thermoplastic polyester	Thermoplastic polyester	Thermoplastic polyester
Operating temperature	-20°C to +85°C	-20°C to +85°C	-25°C to +80°C	-25°C to +80°C
LED colour	Yellow	Yellow	Yellow	Yellow
Special features	Teach-in, humidity compensation NPN/PNP auto detection, remote setup, alarm output. On request: dirt and moisture compensation	Teach-in, humidity compensation NPN/PNP auto detection, remote setup, alarm output. On request: dirt and moisture compensation		
Approvals/Marks	CE - UL - CSA	CE - UL - CSA	CE - UL - CSA	CE - UL - CSA

Capacitive proximity sensors, TRIPLESIELD™

Types M18 TRIPLESIELD™, chemical resistant

Connections 2 m cable 2 m cable 2 m cable

Flush mountable



Dimensions (mm)	M18 x 71.5	M18 x 71.5	M18 x 71.5
Thread (mm)	M18 x 1 x 46.5	M18 x 1 x 46.5	M18 x 1 x 46.5
Operating frequency	30 Hz	30 Hz	30 Hz
Sensing distance (Sn)	3 - 8 mm (adjustable)	3 - 8 mm (adjustable)	3 - 8 mm (adjustable)

References

NPN-NO/NC	CA18HLF08NA	CA18GLF08NA	CA18FLF08NA
PNP-NO/NC	CA18HLF08PA	CA18GLF08PA	CA18FLF08PA

Non-flush mountable



Dimensions (mm)	M18 x 71.5
Thread (mm)	M18 x 1 x 46.5
Operating frequency	30 Hz
Sensing distance (Sn)	3 - 12 mm (adjustable)





References

NPN-NO/NC	CA18HLN12NA
PNP-NO/NC	CA18HLN12PA



Characteristics flush and non-flush mountable

Rated operating voltage	10 - 40 VDC	10 - 40 VDC	10 - 40 VDC
Voltage drop	≤ 2.5 VDC	≤ 2.5 VDC	≤ 2.5 VDC
Degree of protection	IP 67	IP 67	IP 67
Protection Short-circuit (S) Reverse polarity (P) Transients (T)	SPT	SPT	SPT
Output current	< 200 mA	< 200 mA	< 200 mA
Housing material	Polypropylene	PVC	Teflon
Operating temperature	-25°C to +80°C	-25°C to +80°C	-25°C to +80°C
LED colour	Yellow	Yellow	Yellow
Approvals/Marks	CE	CE	CE



Capacitive proximity sensors, TRIPLESIELD™

Types	VC5510	VC5510 Time delay	CD50	CD50
Connections	1.5 m cable	1.5 m cable	2 m cable	2 m cable
Flush mountable				
Dimensions (mm)	55 x 35 x 15	55 x 35 x 15	50 x 30 x 7	50 x 30 x 7
Operating frequency	> 15 Hz	> 0.1 Hz	10 Hz	10 Hz
Sensing distance (Sn)	10 mm	10 mm	6 mm	5 mm
References				
NPN - NO	VC5510NNOP	VC5510NNOPT	CD50CNF06NO	CD50CNF05NO
NPN - NC	VC5510NNCP	VC5510NNCPT		
PNP - NO	VC5510PNOP	VC5510PNOPT		
PNP - NC	VC5510PNCP	VC5510PNCPT		
Sensing distance (Sn)			7 mm	
PNP - NO			CD50CNF07PO	
NPN - NC			CD50CNF07NC	
Sensing distance (Sn)			10 mm	
PNP - NO			CD50CNF10PO	
NPN - NC			CD50CNF10NC	
Characteristics flush and non-flush mountable				
Rated operating voltage	5 - 30 VDC	5 - 30 VDC	10 - 30 VDC	5 VDC
Voltage drop	≤ 1.5 VDC	≤ 1.5 VDC	≤ 1.5 V	≤ 1.5 V
Degree of protection	IP65	IP 65	IP 67	IP 67
Output current	≤ 100 mA	≤ 100 mA	≤ 50 mA	≤ 50 mA
Housing material	PC/ABS	PC/ABS	Noryl, grey	Noryl, grey
Operating temperature	0°C to +50°C	0°C to +50°C	0°C to +60°C	0°C to +60°C
LED colour	Red	Red		
Approvals/Marks	CE - UL	CE - UL	CE	CE





Capacitive proximity sensors, TRIPLESIELD™

Types	CD46 teach-in TRIPLESIELD™	EC 5525 TRIPLESIELD™	
Connections	2 m cable	2 m cable	M12 connector
Flush or non-Flush mountable			
	Dimensions short body (mm)	46 x 28 x 5.5	55 x 35 x 15
Operating frequency	10 Hz	50 Hz	50 Hz
Sensing distance (Sn)	1.0 - 10 mm (Teach-in)	4 - 25 mm	4 - 25 mm
References			
NPN-NO/NC	CD46CNC10NP	EC5525NPAP	EC5525NPAP-1
PNP-NO/NC	CD46CNC10PP	EC5525PPAP	EC5525PPAP-1
Characteristics flush and non-flush mountable			
Rated operating voltage	10 - 30 VDC	10 - 40 VDC	10 - 40 VDC
Voltage drop	≤ 2.5 VDC	≤ 2.5 VDC	≤ 2.5 VDC
Degree of protection	IP 68	IP 67	IP 67
Protection Short-circuit (S) Reverse polarity (P) Transients (T)	SPT	SPT	SPT
Output current	≤ 200 mA	≤ 200 mA	≤ 200 mA
Housing material	PBT	Polycarbonate	Polycarbonate
Operating temperature	-25°C to +80°C	-25°C to +80°C	-25°C to +80°C
LED colour	Yellow, Green	Yellow	Yellow
Special features	Teach-in, remote setup, alarm output		
Approvals/Marks	CE - UL - CSA	CE - UL - CSA	CE - UL - CSA

Capacitive proximity sensors, TRIPLESIELD™

Types	M18 teach-in TRIPLESIELD™		M30 teach-in TRIPLESIELD™	
Connections	2 m cable	M12 connector	2 m cable	M12 connector
Flush or non-flush mountable				
Dimensions (mm)	M18 x 89.55	M18 x 89.2	M30 x 99.2	M30 x 99.45
Thread (mm)	M18 x 1 x 50	M18 x 1 x 50	M30 x 1.5 x 50	M30 x 1.5 x 50
Operating frequency	5 Hz	5 Hz	5 Hz	5 Hz
Sensing distance (Sn)	0.5 - 12 mm (Teach-in)	0.5 - 12 mm (Teach-in)	0.5 - 30 mm (Teach-in)	0.5 - 30 mm (Teach-in)
References				
NPN/PNP, NO/NC	CA18CLL12BP	CA18CLL12BPM1	CA30CLL30BP	CA30CLL30BPM1
Characteristics flush and non-flush mountable				
Rated operating voltage	10 - 40 VDC	10 - 40 VDC	10 - 40 VDC	10 - 40 VDC
Voltage drop	≤ 2.5 VDC	≤ 2.5 VDC	≤ 2.5 VDC	≤ 2.5 VDC
Degree of protection	IP 68	IP 68	IP 68	IP 68
Output current	≤ 250 mA	≤ 250 mA	≤ 250 mA	≤ 250 mA
Housing material	Thermoplastic polyester	Thermoplastic polyester	Thermoplastic polyester	Thermoplastic polyester
Operating temperature	-20°C to +85°C	-20°C to +85°C	-20°C to +85°C	-20°C to +85°C
Max. temperature on sensing face	120°C (248°F)	120°C (248°F)	120°C (248°F)	120°C (248°F)
LED colour	Yellow	Yellow	Yellow	Yellow
Special features	Single-step Teach-in, humidity compensation NPN/ PNP auto detection, remote setup, alarm output. On request: dirt and moisture compensation	Single-step Teach-in, humidity compensation NPN/ PNP auto detection, remote setup, alarm output. On request: dirt and moisture compensation	Single-step Teach-in, humidity compensation NPN/ PNP auto detection, remote setup, alarm output. On request: dirt and moisture compensation	Single-step Teach-in, humidity compensation NPN/ PNP auto detection, remote setup, alarm output. On request: dirt and moisture compensation
Approvals/Marks	CE - UL - CSA	CE - UL - CSA	CE - UL - CSA	CE - UL - CSA

Capacitive level sensors

Types	Capacitive level sensors for solid, fluid and granulated substances			
Connections	2 m cable	2 m cable	2 m cable	2 m cable
				
Dimensions (mm)	Ø32 x 101	Ø32 x 101	Ø32 x 101	M30 x 101
Thread	Smooth	Smooth	Smooth	M30 (with 2 nuts)
Operating frequency	1 Hz	1 Hz	1 Hz	1 Hz
Sensing distance (Sn)	4 - 12 mm (adjustable)	4 - 12 mm (adjustable)	4 - 12 mm (adjustable)	4 - 12 mm (adjustable)
References with ON delay				
Time delay	1 s - 10 m			1 s - 10 m
120 VAC	VC11RT12010M			
230 VAC	VC11RT23010M			
24 VAC/DC	VC11RT92410M			
24-230 VAC/DC	VC11RTM2410M			CA30CLN12MU10M
References with OFF delay				
Time delay	1 s - 10 m			1 s - 10 m
120 VAC	VC12RT12010M			
230 VAC	VC12RT23010M			
24 VAC/DC	VC12RT92410M			
24-230 VAC/DC	VC12RTM2410M			CA30CLN12MV10M
References without delay				
120 VAC	VC12RN120			
230 VAC	VC12RN230			
24 VAC/DC	VC12RN924			
24-230 VAC/DC	VC12RNM24			CA30CLN12MT
Specifications				
Consumption	≤ 1.5 W	≤ 1.5 W	≤ 1.5 W	≤ 2.5 W
Consumption M24 versions	≤ 2.5 W	≤ 2.5 W	≤ 2.5 W	
Hysteresis	1.5 mm at 7 mm sensing distance	1.5 mm at 7 mm sensing distance	1.5 mm at 7 mm sensing distance	3 - 20%
Output	Relay SPDT 2 A / 240 VAC	Relay SPDT 2 A / 240 VAC	Relay SPDT 2 A / 240 VAC	Relay SPDT 2 A / 240 VAC
Degree of protection	IP 67	IP 67	IP 67	IP 67
Housing material	Thermoplastic polyester	Thermoplastic polyester	Thermoplastic polyester	PBT, grey
Operating temperature	-20°C to +70°C	-20°C to +70°C	-20°C to +70°C	-20°C to +70°C
LED colour	Red	Red	Red	Yellow
Approvals/Marks	CE	CE - CSA	CE	CE, CSA
UL508	cULus (M24 versions)	cULus (M24 versions)	cULus (M24 versions)	cULus
NEMA				1, 2, 4, 4X, 5, 6, 6P, 12

Capacitive level sensors

	Ø18 sensors for solid, fluid and granulated substances		Ø32 sensors
Types	2-wire, AC	3-wire, DC	2-wire, AC
Connections	2 m cable	2 m cable	2 m cable
			
Dimensions (mm)	Ø18 x 86	Ø18 x 86	Ø32 x 101
Thread	Smooth	Smooth	Smooth
Operating frequency	10 Hz	30 Hz	10 Hz
Sensing distance (Sn)	3 - 12 mm (adjustable)	3 - 12 mm (adjustable)	2 - 20 mm (adjustable)
References			
Thyristor (SCR) NO	CB18CLN12TOFT		
Thyristor (SCR) NO ATEX	CB18CLN12TOFTAX		
Thyristor (SCR) NC	CB18CLN12TCFT		
Thyristor (SCR) NC ATEX	CB18CLN12TCFTAX		
NPN - NO/NC		CB18CLN12NA	
NPN - NO/NC ATEX		CB18CLN12NAAX	
PNP - NO/NC		CB18CLN12PA	
PNP - NO/NC ATEX		CB18CLN12PAAX	
ON-delay			No
Thyristor (SCR) NO			CB32CLN20TO
Thyristor (SCR) NO ATEX			CB32CLN20TOAX
Thyristor (SCR) NC			CB32CLN20TC
Thyristor (SCR) NC ATEX			CB32CLN20TCAX
ON-delay			Yes
Thyristor (SCR) NO			CB32CLN20TOFT
Thyristor (SCR) NO ATEX			CB32CLN20TOFTAX
Thyristor (SCR) NC			CB32CLN20TCFT
Thyristor (SCR) NC ATEX			CB32CLN20TCFTAX
Specifications			
Rated operating voltage	20 - 250 VAC	10 - 40 VDC	20 - 250 VAC
Voltage drop	≤ 10 VAC	≤ 10 VAC	≤ 10 VAC
Time delay	30 s ON-delay		30 s ON-delay
Degree of protection	IP 67	IP 67	IP 67
Protection Short-circuit (S) Reverse polarity (P) Transients (T)	T	SPT	T
Output current	≤ 500 mA	≤ 200 mA	≤ 500 mA
Housing material	Thermoplastic polyester	Thermoplastic polyester	Thermoplastic polyester
Operating temperature	-25°C to +80°C	-25°C to +80°C	-20°C to +70°C
LED colour	Yellow	Yellow	Yellow
Approvals/Marks	CE - UL - CSA - ATEX	CE - UL - CSA - ATEX	CE - UL - CSA - ATEX

Capacitive level sensors

Types Ø32 level sensors TRIPLESIELD™ - ATEX

Connections	With ON delay	With OFF delay	Without time delay
-------------	---------------	----------------	--------------------



Dimensions (mm)	Ø32 x 101	Ø32 x 101	Ø32 x 101
Thread	Smooth	Smooth	Smooth
Operating frequency	5 Hz	5 Hz	5 Hz
Sensing distance (Sn)	4 - 20 mm (adjustable)	4 - 20 mm (adjustable)	4 - 20 mm (adjustable)





References

Cable length	2 m	2 m	2 m
120 VAC	CB32CLN20SUAX	CB32CLN20SVAX	CB32CLN20STAX
230 VAC	CB32CLN20RUAX	CB32CLN20RVAX	CB32CLN20RTAX
24 VAC/DC	CB32CLN20QUAX	CB32CLN20QVAX	CB32CLN20QTAX
Cable length	5 m	5 m	5 m
120 VAC	CB32CLN20SUAX5M	CB32CLN20SVAX5M	CB32CLN20STAX5M
230 VAC	CB32CLN20RUAX5M	CB32CLN20RVAX5M	CB32CLN20RTAX5M
24 VAC/DC	CB32CLN20QUAX5M	CB32CLN20QVAX5M	CB32CLN20QTAX5M
Cable length	10 m	10 m	10 m
120 VAC	CB32CLN20SUAX10M	CB32CLN20SVAX10M	CB32CLN20STAX10M
230 VAC	CB32CLN20RUAX10M	CB32CLN20RVAX10M	CB32CLN20RTAX10M
24 VAC/DC	CB32CLN20QUAX10M	CB32CLN20QVAX10M	CB32CLN20QTAX10M

Specifications

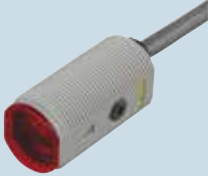

Consumption	< 1.5 W	< 1.5 W	< 1.5 W
Hysteresis	3 to 20% of sensing distance	3 to 20% of sensing distance	3 to 20% of sensing distance
Output	Relay SPDT, 2 A / 240 VAC	Relay SPDT, 2 A / 240 VAC	Relay SPDT, 2 A / 240 VAC
Time delay	1 s - 10 m	1 s - 10 m	
Degree of protection	IP 67	IP 67	IP 67
Housing material	PBT	PBT	PBT
Operating temperature	-20°C to +70°C	-20°C to +70°C	-20°C to +70°C
LED colour	Yellow	Yellow	Yellow
Approvals/Marks	CE - ATEX	CE - ATEX	CE - ATEX

Photoelectric sensors

	M18, DC, axial type		M18, DC, radial type	
Types	PA18CA.	PA18CA.	PA18CR.	PA18CR.
Connections	2 m cable	M12 connector	2 m cable	M12 connector
				
Dimensions (mm)	M18 x 40	M18 x 44	M18 x 50	M18 x 54
Diffuse reflective				
Sensing distance (Sn)	50 - 1000 mm	50 - 1000 mm	50 - 800 mm	50 - 800 mm
NPN NO+NC	PA18CAD10NASA	PA18CAD10NAM1SA	PA18CRD08NASA	PA18CRD08NAM1SA
PNP NO+NC	PA18CAD10PASA	PA18CAD10PAM1SA	PA18CRD08PASA	PA18CRD08PAM1SA
Diffuse reflective WS				
Sensing distance (Sn)	0 - 400 mm	0 - 400 mm		
NPN NO+NC	PA18CAD04NAWS	PA18CAD04NAM1WS		
PNP NO+NC	PA18CAD04PAWS	PA18CAD04PAM1WS		
Retro reflective polarized				
Sensing distance (Sn)	5 - 500 cm	5 - 500 cm	5 - 400 cm	5 - 400 cm
NPN NO+NC	PA18CAP50NASA	PA18CAP50NAM1SA	PA18CRP40NASA	PA18CRP40NAM1SA
PNP NO+NC	PA18CAP50PASA	PA18CAP50PAM1SA	PA18CRP40PASA	PA18CRP40PAM1SA
Retro reflective				
Sensing distance (Sn)	5 - 650 cm	5 - 650 cm	5 - 500 cm	5 - 500 cm
NPN NO+NC	PA18CAR65NASA	PA18CAR65NAM1SA	PA18CRR50NASA	PA18CRR50NAM1SA
PNP NO+NC	PA18CAR65PASA	PA18CAR65PAM1SA	PA18CRR50PASA	PA18CRR50PAM1SA
Through-beam emitter (E)				
Sensing distance (Sn)	1 - 20 m	1 - 20 m	1 - 16 m	1 - 16 m
	PA18CAT20	PA18CAT20M1	PA18CRT16	PA18CRT16M1
Through-beam receiver (R)				
Sensing distance (Sn)	1 - 20 m	1 - 20 m	1 - 16 m	1 - 16 m
NPN NO+NC	PA18CAT20NASA	PA18CAT20NAM1SA	PA18CRT16NASA	PA18CRT16NAM1SA
PNP NO+NC	PA18CAT20PASA	PA18CAT20PAM1SA	PA18CRT16PASA	PA18CRT16PAM1SA
Background suppression (BGS)				
Sensing distance (Sn)	10 - 200 mm	10 - 200 mm		
NPN NO+NC	PA18CAB20NASA	PA18CAB20NAM1SA		
PNP NO+NC	PA18CAB20PASA	PA18CAB20PAM1SA		
Specifications				
Operating frequency	500 Hz	500 Hz	500 Hz	500 Hz
Rated operating voltage	10 - 30 VDC	10 - 30 VDC	10 - 30 VDC	10 - 30 VDC
Voltage drop	≤ 2.0 VDC @ 100 mA	≤ 2.0 VDC @ 100 mA	≤ 2.0 VDC @ 100 mA	≤ 2.0 VDC @ 100 mA
Degree of protection	IP 67 + IP 69K	IP 67 + IP 69K	IP 67 + IP 69K	IP 67 + IP 69K
Protection Short-circuit (S)				
Reverse polarity (P)	SPT	SPT	SPT	SPT
Transients (T)				
Supply current	≤ 25 mA @ 24 VDC	≤ 25 mA @ 24 VDC	≤ 25 mA @ 24 VDC	≤ 25 mA @ 24 VDC
BGS, E + R	≤ 40 mA @ 24 VDC	≤ 40 mA @ 24 VDC	≤ 40 mA @ 24 VDC	≤ 40 mA @ 24 VDC
Housing material	ABS, PMMA, PBTB	ABS, PMMA, PBTB	ABS, PMMA, PBTB	ABS, PMMA, PBTB
Operating temperature	-25°C to +60°C	-25°C to +60°C	-25°C to +60°C	-25°C to +60°C
LED colour	Yellow, Green	Yellow, Green	Yellow, Green	Yellow, Green
Approvals/Marks	CE - cULus - ECOLAB	CE - cULus - ECOLAB	CE - cULus - ECOLAB	CE - cULus - ECOLAB



Photoelectric sensors

M18, DC, square type

Types	PH18.	PH18.	PH18.
Connections	2 m cable	M12 connector	Pigtail M12
			
Dimensions (mm)	15 x 21 (31.5) x 35	15 x 21 (31.5) x 35	15 x 21 (31.5) x 35
Diffuse reflective			
Sensing distance (Sn)	50 - 1000 mm	50 - 1000 mm	50 - 1000 mm
NPN NO+NC	PH18CND10NASA	PH18CND10NAM1SA	PH18CND10NAT1SA
PNP NC+NC	PH18CND10PASA	PH18CND10PAM1SA	PH18CND10PAT1SA
Retro reflective polarized			
Sensing distance (Sn)	5 - 500 cm	5 - 500 cm	5 - 500 cm
NPN NO+NC	PH18CNP50NASA	PH18CNP50NAM1SA	PH18CNP50NAT1SA
PNP NO+NC	PH18CNP50PASA	PH18CNP50PAM1SA	PH18CNP50PAT1SA
Retro reflective			
Sensing distance (Sn)	5 - 650 cm	5 - 650 cm	5 - 650 cm
NPN NO+NC	PH18CNR65NASA	PH18CNR65NAM1SA	PH18CNR65NAT1SA
PNP NO+NC	PH18CNR65PASA	PH18CNR65PAM1SA	PH18CNR65PAT1SA
Through-beam emitter (E)			
Sensing distance (Sn)	1 - 20 m	1 - 20 m	1 - 20 m
	PH18CNT20	PH18CNT20M1	PH18CNT20T1
Through-beam receiver (R)			
Sensing distance (Sn)	1 - 20 m	1 - 20 m	1 - 20 m
NPN NO+NC	PH18CNT20NASA	PH18CNT20NAM1SA	PH18CNT20NAT1SA
PNP NO+NC	PH18CNT20PASA	PH18CNT20PAM1SA	PH18CNT20PAT1SA
Background suppression (BGS)			
Sensing distance (Sn)	8 - 200 mm	8 - 200 mm	8 - 200 mm
NPN NO+NC	PH18CNB20NASA	PH18CNB20NAM1SA	PH18CNB20NAT1SA
PNP NO+NC	PH18CNB20PASA	PH18CNB20PAM1SA	PH18CNB20PAT1SA
Specifications			
Operating frequency	500 Hz	500 Hz	500 Hz
Rated operating voltage	10 - 30 VDC	10 - 30 VDC	10 - 30 VDC
Voltage drop	≤ 2.0 VDC @ 100 mA	≤ 2.0 VDC @ 100 mA	≤ 2.0 VDC @ 100 mA
Degree of protection	IP 67 + IP 69K	IP 67 + IP 69K	IP 67 + IP 69K
Protection Short-circuit (S)			
Reverse polarity (P)	SPT	SPT	SPT
Transients (T)			
Supply current	≤ 25 mA @ 24 VDC	≤ 25 mA @ 24 VDC	≤ 25 mA @ 24 VDC
BGS, E + R	≤ 40 mA @ 24 VDC	≤ 40 mA @ 24 VDC	≤ 40 mA @ 24 VDC
Housing material	ABS, PMMA	ABS, PMMA	ABS, PMMA
Operating temperature	-25°C to +60°C	-25°C to +60°C	-25°C to +60°C
LED colour	Yellow, Green	Yellow, Green	Yellow, Green
Approvals/Marks	CE - cULus - ECOLAB	CE - cULus - ECOLAB	CE - cULus - ECOLAB

Photoelectric sensors

M18 metal, DC, integrated amplifier

Types	E.18..	E.18..-1
Connections	2 m cable	M12 connector
		
Dimensions (mm)	M18 x 55	M18 x 67
Diffuse reflective		
Operating frequency	120 Hz	120 Hz
Sensing distance (Sn)	400 mm, adjustable	400 mm, adjustable
NPN NO+NC	EO1804NPAS	EO1804NPAS-1
PNP NC+NC	EO1804PPAS	EO1804PPAS-1
Retro reflective polarized		
Operating frequency	100 Hz	100 Hz
Sensing distance (Sn)	2 m, adjustable	2 m, adjustable
NPN NO+NC	EP1820NPAS	EP1820NPAS-1
PNP NO+NC	EP1820PPAS	EP1820PPAS-1
Retro reflective		
Operating frequency	120 Hz	120 Hz
Sensing distance (Sn)	3 m, adjustable	3 m, adjustable
NPN NO+NC	ER1830NPAS	ER1830NPAS-1
PNP NO+NC	ER1830PPAS	ER1830PPAS-1
Through-beam emitter		
Sensing distance (Sn)	20 m ET1820	20 m ET1820-1
Through-beam receiver		
Operating frequency	170 Hz	170 Hz
Sensing distance (Sn)	20 m, adjustable	20 m, adjustable
NPN NO+NC	ET1820NPAS	ET1820NPAS-1
PNP NO+NC	ET1820PPAS	ET1820PPAS-1
Fiber optic		
Operating frequency	120 Hz	120 Hz
Sensing distance (Sn)	Fibre dependent	Fibre dependent
NPN NO+NC	EF1801NPAS	EF1801NPAS-1
PNP NO+NC	EF1801PPAS	EF1801PPAS-1
Specifications		
Rated operating voltage	10 - 40 VDC	10 - 40 VDC
Voltage drop	≤ 2.5 VDC	≤ 2.5 VDC
Degree of protection	IP 67	IP 67
Protection Short-circuit (S) Rev. polarity (P) Transients (T)	SPT	SPT
Load current	< 200 mA	< 200 mA
Housing material	Nickel-plated brass	Nickel-plated brass
Operating temperature	-20°C to +60°C	-20°C to +60°C
LED colour	Yellow	Yellow
Approvals/Marks	CE	CE

Photoelectric sensors

M18 plastic, AC, integrated amplifier

M18 metal, AC, integrated amplifier

Types	PA18CL	PA18CL.M6	PA18AL	PA18AL..M6
Connections	2 m cable	M12 connector	2 m cable	M12 connector



Dimensions (mm)	M18 x 71.5	M18 x 83.5	M18 x 71.5	M18 x 83.5
-----------------	------------	------------	------------	------------

Diffuse reflective

Operating frequency	20 Hz	20 Hz	20 Hz	20 Hz
Sensing distance (Sn)	100 mm, fixed	100 mm, fixed		
Thyristor (SCR) NC	PA18CLD01TC	PA18CLD01TCM6		
Thyristor (SCR) NO	PA18CLD01TO	PA18CLD01TOM6		
Sensing distance (Sn)	200 mm, fixed	200 mm, fixed		
Thyristor (SCR) NC	PA18CLD02TC	PA18CLD02TCM6		
Thyristor (SCR) NO	PA18CLD02TO	PA18CLD02TOM6		
Sensing distance (Sn)	400 mm, fixed	400 mm, fixed		
Thyristor (SCR) NC	PA18CLD04TC	PA18CLD04TCM6		
Thyristor (SCR) NO	PA18CLD04TO	PA18CLD04TOM6		
Sensing distance (Sn)	400 mm, adjustable	400 mm, adjustable	400 mm, adjustable	400 mm, adjustable
Thyristor (SCR) NC	PA18CLD04TCSA	PA18CLD04TCM6SA	PA18ALD04TCSA	PA18ALD04TCM6SA
Thyristor (SCR) NO	PA18CLD04TOSA	PA18CLD04TOM6SA	PA18ALD04TOSA	PA18ALD04TOM6SA

Retro reflective polarized

Operating frequency	25 Hz	25 Hz	25 Hz	25 Hz
Sensing distance (Sn)	2 m, fixed	2 m, fixed	2 m, adjustable	2 m, adjustable
Thyristor (SCR) NC	PA18CLP20TC	PA18CLP20TCM6	PA18ALP20TCSA	PA18ALP20TCM6SA
Thyristor (SCR) NO	PA18CLP20TO	PA18CLP20TOM6	PA18ALP20TOSA	PA18ALP20TOM6SA

Retro reflective





Operating frequency	20 Hz	20 Hz	20 Hz	20 Hz
Sensing distance (Sn)	3 m, fixed	3 m, fixed	3 m, adjustable	3 m, adjustable
Thyristor (SCR) NC	PA18CLR30TC	PA18CLR30TCM6	PA18ALR30TCSA	PA18ALR30TCM6SA
Thyristor (SCR) NO	PA18CLR30TO	PA18CLR30TOM6	PA18ALR30TOSA	PA18ALR30TOM6SA

Specifications



Rated operating voltage	20 - 250 VAC	20 - 250 VAC	20 - 250 VAC	20 - 250 VAC
Voltage drop	≤ 10 VAC	≤ 10 VAC	≤ 10 VAC	≤ 10 VAC
Off state current	≤ 5 mA AC	≤ 5 mA AC	≤ 5 mA AC	≤ 5 mA AC
Degree of protection	IP 67	IP 67	IP 67	IP 67
Protection Short-circuit (S)				
Reverse polarity (P)	PT	PT	PT	PT
Transients (T)				
Load current	< 500 mA	< 500 mA	< 500 mA	< 500 mA
Housing material	Polyester (PBTP)	Polyester (PBTP)	Nickel-plated brass	Nickel-plated brass
Operating temperature	-20°C to +60°C	-20°C to +60°C	-20°C to +60°C	-20°C to +60°C
LED colour	Yellow	Yellow	Yellow	Yellow
Approvals/Marks	CE - UL - CSA	CE - UL - CSA	CE - UL - CSA	CE - UL - CSA

Photoelectric sensors

Integrated amplifier

Types	PD30 Stainless Steel AISI 316L		PD30 ABS Housing Back Potentiometer	
Connections	2 m cable	M8 connector	2 m cable	M8 connector
				
Dimensions (mm)	11 x 31.5 x 21	11 x 31.5 x 21	10 x 30 x 20	10 x 30 x 20
Diffuse reflective				
Operating frequency / Sensing distance (Sn)	1000 Hz / 1 m	1000 Hz / 1m	1000 Hz / 1 m	1000 Hz / 1m
NPN NO+NC	PD30ETD10NASA	PD30ETD10NAM5SA	PD30CND10NASA	PD30CND10NAM5SA
PNP NO+NC	PD30ETD10PASA	PD30ETD10PAM5SA	PD30CND10PASA	PD30CND10PAM5SA
Diffuse reflective, extremely wide angle, infrared light				
Operating frequency / Sensing distance (Sn)	1000 Hz / 200 mm	1000 Hz / 200mm		
NPN NO+NC	PD30ETD02NAWE	PD30ETD02NAM5WE		
PNP NO+NC	PD30ETD02PAWE	PD30ETD02PAM5WE		
Diffuse reflective background suppression, red light				
Operating frequency / Sensing distance (Sn)	500 Hz / 200 mm	500 Hz / 200 mm	500 Hz / 200 mm	500 Hz / 200 mm
NPN NO+NC	PD30ETB20NASA	PD30ETB20NAM5SA	PD30CNB20NASA	PD30CNB20NAM5SA
PNP NO+NC	PD30ETB20PASA	PD30ETB20PAM5SA	PD30CNB20PASA	PD30CNB20PAM5SA
Diffuse reflective background suppression, infrared light				
Operating frequency / Sensing distance (Sn)	500 Hz / 200 mm	500 Hz / 200 mm	500 Hz / 200 mm	500 Hz / 200 mm
NPN NO+NC	PD30ETB20NAIS	PD30ETB20NAM5IS	PD30CNB20NAIS	PD30CNB20NAM5IS
PNP NO+NC	PD30ETB20PAIS	PD30ETB20PAM5IS	PD30CNB20PAIS	PD30CNB20PAM5IS
Retro-Reflective				
Operating frequency / Sensing distance (Sn)	1000 Hz / 6 m	1000 Hz / 6 m	1000 Hz / 6 m	1000 Hz / 6 m
NPN NO+NC	PD30ETR60NASA	PD30ETR60NAM5SA	PD30CNR60NASA	PD30CNR60NAM5SA
PNP NO+NC	PD30ETR60PASA	PD30ETR60PAM5SA	PD30CNR60PASA	PD30CNR60PAM5SA
Retro reflective polarized				
Operating frequency / Sensing distance (Sn)	1000 Hz / 6 m	1000 Hz / 6 m	1000 Hz / 6 m	1000 Hz / 6 m
NPN NO+NC	PD30ETP60NASA	PD30ETP60NAM5SA	PD30CNP60NASA	PD30CNP60NAM5SA
PNP NO+NC	PD30ETP60PASA	PD30ETP60PAM5SA	PD30CNP60PASA	PD30CNP60PAM5SA
Through-beam emitter				
Sensing distance (Sn)	15 m	15 m	15 m	15 m
	PD30ETT15	PD30ETT15M5	PD30CNT15	PD30CNT15M5
Through-beam receiver				
Operating frequency / Sensing distance (Sn)	500 Hz / 15 m	500 Hz / 15 m	500 Hz / 15 m	500 Hz / 15 m
NPN NO/NC	PD30ETT15NASA	PD30ETT15M5NASA	PD30CNT15NASA	PD30CNT15NAM5SA
PNP NO/NC	PD30ETT15PASA	PD30ETT15M5PASA	PD30CNT15PASA	PD30CNT15PAM5SA
Specifications				
Rated operating voltage	10 - 30 VDC	10 - 30 VDC	10 - 30 VDC	10 - 30 VDC
Voltage drop	≤ 2.0 VDC@100 mA	≤ 2.0 VDC@100 mA	≤ 2.0 VDC@100 mA	≤ 2.0 VDC@100 mA
Degree of protection	IP 68, IP69K	IP 68, IP69K	IP 67	IP 67
Protection Short-circuit (S)				
Reverse polarity (P)	SPT	SPT	SPT	SPT
Transients (T)				
Load current	≤ 100 mA	≤ 100 mA	≤ 100 mA	≤ 100 mA
Housing material	Stainless Steel AISI 316L	Stainless Steel AISI 316L	ABS	ABS
Operating temperature	-40 (-25)°C to +60°C	-40 (-25)°C to +60°C	-25°C to +60°C	-25°C to +60°C
LED colour	Yellow + Green	Yellow + Green	Yellow + Green	Yellow + Green
Approvals/Marks UL508	CE - cULus - ECOLAB	CE - cULus - ECOLAB	CE - cULus	CE - cULus

Photoelectric sensors

Integrated amplifier			
Types	PD30 PointSpot Back Potentiometer		PD30 Top Potentiometer
Connections	2 m cable	M8 connector	2 m cable
			
Dimensions (mm)	10 x 30 x 20	10 x 30 x 20	10 x 30 x 20
Diffuse reflective			
Operating frequency / Sensing distance (Sn)			1000 Hz / 1m
NPN NO+NC			PD30CTD10NASA
PNP NO+NC			PD30CTD10PASA
Diffuse reflective, extremely wide angle, infrared light			
Operating frequency / Sensing distance (Sn)			1000 Hz / 200 mm
NPN NO+NC			PD30CTD02NAWE
PNP NO+NC			PD30CTD02PAWE
Diffuse reflective background suppression, red light			
Operating frequency / Sensing distance (Sn)	500 Hz / 250 mm	500 Hz / 250 mm	500 Hz / 200 mm
NPN NO+NC	PD30CNB25NAPS	PD30CNB25NAM5PS	PD30CTB20NASA
PNP NO+NC	PD30CNB25PAPS	PD30CNB25PAM5PS	PD30CTB20PASA
Diffuse reflective background suppression, infrared light			
Operating frequency / Sensing distance (Sn)			500 Hz / 200 mm
NPN NO+NC			PD30CTB20NAIS
PNP NO+NC			PD30CTB20PAIS
Retro reflective polarized			
Operating frequency / Sensing distance (Sn)	1000 Hz / 6 m	1000 Hz / 6 m	
NPN NO+NC	PD30CNP50NAPS	PD30CNP50NAM5PS	
PNP NO+NC	PD30CNP50PAPS	PD30CNP50PAM5PS	
Specifications			
Rated operating voltage	10 - 30 VDC	10 - 30 VDC	10 - 30 VDC
Voltage drop	≤ 2.0 VDC@100 mA	≤ 2.0 VDC@100 mA	≤ 2.0 VDC@100 mA
Degree of protection	IP 67	IP 67	IP 67
Protection Short-circuit (S)			
Reverse polarity (P)	SPT	SPT	SPT
Transients (T)			
Load current	≤ 100 mA	≤ 100 mA	≤ 100 mA
Housing material	ABS	ABS	ABS
Operating temperature	-25°C to +60°C	-25°C to +60°C	-25°C to +60°C
LED colour	Yellow + Green	Yellow + Green	Yellow + Green
Approvals/Marks UL508	CE - cULus	CE - cULus	CE - cULus

Photoelectric sensors

Integrated amplifier

Types

PD30 - Advanced with teach-in

Connections

2 m cable

M8 connector

2 m cable

M8 connector



Dimensions (mm)	10 x 30 x 20	10 x 30 x 20	10 x 30 x 20	10 x 30 x 20
-----------------	--------------	--------------	--------------	--------------

Retro reflective

Retro reflective - transparent objects

Operating frequency / Sensing distance (Sn)	1000 Hz / 6 m, Teach-in	1000 Hz / 6 m, Teach-in	1000 Hz / 2 m, Teach-in	1000 Hz / 2 m, Teach-in
Mute NPN NO/NC	PD30CNR06NPMU	PD30CNR06NPM5MU	PD30CNG02NPMU	PD30CNG02NPM5MU
Mute PNP NO/NC	PD30CNR06PPMU	PD30CNR06PPM5MU	PD30CNG02PPMU	PD30CNG02PPM5MU
Dust NPN NO/NC	PD30CNR06NPDU	PD30CNR06NPM5DU		
Dust PNP NO/NC	PD30CNR06PPDU	PD30CNR06PPM5DU		
Remote NPN NO/NC	PD30CNR06NPRT	PD30CNR06NPM5RT	PD30CNG02NPRT	PD30CNG02NPM5RT
Remote PNP NO/NC	PD30CNR06PPRT	PD30CNR06PPM5RT	PD30CNG02PPRT	PD30CNG02PPM5RT

Retro reflective polarized

Diffuse Reflective

Operating frequency / Sensing distance (Sn)	1000 Hz / 6 m, Teach-in	1000 Hz / 6 m, Teach-in	1000 Hz / 1 m, Teach-in	1000 Hz / 1 m, Teach-in
Mute NPN NO/NC	PD30CNP06NPMU	PD30CNP06NPM5MU		
Mute PNP NO/NC	PD30CNP06PPMU	PD30CNP06PPM5MU		
Dust NPN NO/NC	PD30CNP06NPDU	PD30CNP06NPM5DU	PD30CND10NPDU	PD30CND10NPM5DU
Dust PNP NO/NC	PD30CNP06PPDU	PD30CNP06PPM5DU	PD30CND10PPDU	PD30CND10PPM5DU
Remote NPN NO/NC	PD30CNP06NPRT	PD30CNP06NPM5RT	PD30CND10NPRT	PD30CND10NPM5RT
Remote PNP NO/NC	PD30CNP06PPRT	PD30CNP06PPM5RT	PD30CND10PPRT	PD30CND10PPM5RT

Through-beam emitter

Sensing distance (Sn)	15 m, Teach-in	15 m, Teach-in		
NPN	PD30CNT15NMU	PD30CNT15NM5MU		
PNP	PD30CNT15PMU	PD30CNT15PM5MU		



Through-beam receiver mute function

Operating frequency / Sensing distance (Sn)	1000 Hz / 15 m, Teach-in	1000 Hz / 15 m, Teach-in	1000 Hz / 150 mm, Teach-in	1000 Hz / 150 mm, Teach-in
Remote NPN NO/NC	PD30CNT15NPRT	PD30CNT15NPM5RT	PD30CNB15NPRT	PD30CNB15NPM5RT
Remote PNP NO/NC	PD30CNT15PPRT	PD30CNT15PPM5RT	PD30CNB15PPRT	PD30CNB15PPM5RT
Dust NPN NO/NC	PD30CNT15NPDU	PD30CNT15NPM5DU		
Dust PNP NO/NC	PD30CNT15PPDU	PD30CNT15PPM5DU		

Specifications



Rated operating voltage	10 - 30 VDC	10 - 30 VDC	10 - 30 VDC	10 - 30 VDC
Voltage drop	≤ 2.4 VDC@100 mA	≤ 2.4 VDC@100 mA	≤ 2.4 VDC@100 mA	≤ 2.4 VDC@100 mA
Degree of protection	IP 67	IP 67	IP 67	IP 67
Protection Short-circuit (S)				
Reverse polarity (P)	SPT	SPT	SPT	SPT
Transients (T)				
Load current	≤ 100 mA	≤ 100 mA	≤ 100 mA	≤ 100 mA
Housing material	ABS	ABS	ABS	ABS
Operating temperature	-25°C to +55°C	-25°C to +55°C	-25°C to +55°C	-25°C to +55°C
LED colour	Yellow + Green	Yellow + Green	Yellow + Green	Yellow + Green
Approvals/Marks UL508	CE - cULus	CE - cULus	CE - cULus	CE - cULus

Photoelectric sensors

	Laser miniature, DC, integrated amplifier		Fiber optic sensor
Types	LD32	LD32	FA1
Connections	2 m cable	M8 connector	2m cable
			
Dimensions (mm)	12 x 20 x 32	12 x 20 x 32	10 x 33 x 80
Diffuse reflective			
Operating frequency	4000 Hz	4000 Hz	200, 500, 1000, 5000 μ S
Sensing distance (Sn)	150 mm, Teach-in	150 mm, Teach-in	Fiber dependent
NPN NO+NC	LD32CND15NPT	LD32CND15NPM5T	FA1-N
PNP NO+NC	LD32CND15PPT	LD32CND15PPM5T	FA1-P
Diffuse reflective background suppression			
Operating frequency	4000 Hz	4000 Hz	
Sensing distance (Sn)	60 mm, Teach-in	60 mm, Teach-in	
NPN NO+NC	LD32CNB06NPT	LD32CNB06NPM5T	
PNP NO+NC	LD32CNB06PPT	LD32CNB06PPM5T	
Retro reflective polarized			
Operating frequency	4000 Hz	4000 Hz	
Sensing distance (Sn)	1 m, Teach-in	1 m, Teach-in	
NPN NO+NC	LD32CNP10NPT	LD32CNP10NPM5T	
PNP NO+NC	LD32CNP10PPT	LD32CNP10PPM5T	
Specifications			
Rated operating voltage	10 - 30 VDC	10 - 30 VDC	12 to 24 VDC
Voltage drop	≤ 2.4 VDC	≤ 2.4 VDC	≤ 1.5 VDC
Degree of protection	IP 67	IP 67	IP 40
Protection Short-circuit (S) Reverse polarity (P) Transients (T)	SPT	SPT	SPT
Load current	≤ 100 mA	≤ 100 mA	≤ 100 mA
Housing material	ABS	ABS	ABS
Operating temperature	-25°C to +60°C	-25°C to +60°C	0°C to +60°C
LED colour	Yellow + Green	Yellow + Green	Red + Green
Approvals/Marks UL508	CE	CE	CE cULus (UL508)
Light Source	Laser Class 2	Laser Class 2	Red LED 660 nm
Plastic Fiber unit			FUR (reflective) & FUT (through beam) series. Please refer to FUR FUT specifications datasheets

Photoelectric sensors

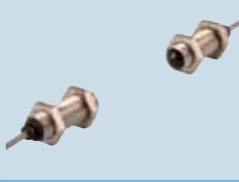
Through-beam, transistor output

Types	PB10..	PA12	PB18..	PE12..
Connections	5 m cable	M12 connector	5 m cable	5 m cable
				

Dimensions (mm)	Ø10	M12	Ø18	Ø12
-----------------	-----	-----	-----	-----

Through-beam emitter

Sensing distance (Sn)	20 m	20 m	15 m	15 m
Single channel	PB10CNT20	PA12BNT20	PB18CNT15	PE12CNT15
Channel 1	PB10C1T20	PA12B1T20		PE12C1T15
Channel 2	PB10C2T20	PA12B2T20		PE12C2T15
Channel 3	PB10C3T20	PA12B3T20		PE12C3T15

Through-beam receiver

Operating frequency	100 Hz (for 3 ch 30 Hz)	100 Hz (for 3 ch 30 Hz)	100 Hz	100 Hz
Sensing distance (Sn)	25 m	25 m	15 m	15 m
NPN NO Single channel	PB10CNT20NO	PA12BNT20NO	PB18CNT15NO	PE12CNT15NO
NPN NC Single channel	PB10CNT20NC	PA12BNT20NC	PB18CNT15NC	PE12CNT15NC
PNP NO Single channel	PB10CNT20PO	PA12BNT20PO	PB18CNT15PO	PE12CNT15PO
PNP NC Single channel	PB10CNT20PC	PA12BNT20PC	PB18CNT15PC	PE12CNT15PC
NPN NO Channel 1	PB10C1T20NO	PA12B1T20NO		PE12C1T15NO
NPN NC Channel 1	PB10C1T20NC	PA12B1T20NC		PE12C1T15NC
PNP NO Channel 1	PB10C1T20PO	PA12B1T20PO		PE12C1T15PO
PNP NC Channel 1	PB10C1T20PC	PA12B1T20PC		PE12C1T15PC
NPN NO Channel 2	PB10C2T20NO	PA12B2T20NO		PE12C2T15NO
NPN NC Channel 2	PB10C2T20NC	PA12B2T20NC		PE12C2T15NC
PNP NO Channel 2	PB10C2T20PO	PA12B2T20PO		PE12C2T15PO
PNP NC Channel 2	PB10C2T20PC	PA12B2T20PC		PE12C2T15PC
NPN NO Channel 3	PB10C3T20NO	PA12B3T20NO		PE12C3T15NO
NPN NC Channel 3	PB10C3T20NC	PA12B3T20NC		PE12C3T15NC
PNP NO Channel 3	PB10C3T20PO	PA12B3T20PO		PE12C3T15PO
PNP NC Channel 3	PB10C3T20PC	PA12B3T20PC		PE12C3T15PC

Specifications

Rated operating voltage	10 - 30 VDC	10 - 30 VDC	10 - 30 VDC	10 - 30 VDC
Voltage drop	≤ 1.5 VDC	≤ 1.5 VDC	≤ 1.5 VDC	≤ 1.5 VDC
Degree of protection	IP 67	IP 67	IP 67	IP 67
Protection Short-circuit (S)				
Reverse polarity (P)	SPT	SPT	SPT	SPT
Transients (T)				
Load current	≤ 100 mA	≤ 100 mA	≤ 100 mA	≤ 100 mA
Housing material	PC	PC	PTE	PC
Operating temperature	-20°C to +50°C	-20°C to +50°C	-20°C to +50°C	-20°C to +50°C
LED colour	Green (E), Yellow (R)	Green (E), Yellow (R)		Green (E), Yellow (R)
Approvals/Marks	CE	CE	CE	CE
UL 508	cULus	UL - cUL	cULus	cULus
UL 325	cURus	UR - cURus	cURus	cURus

NB! For pig-tail connector versions add C2 after the part number

Photoelectric sensors

DC, integrated amplifier

Types	PD70	PD112	PA.	PB.
Connections	2 m cable or connector		2 m cable or connector	
				

Dimensions (mm)	11.6 x 11.6 x 70	112 x 45 x 25	36 x 18 x 63	18 x 75 x 36
-----------------	------------------	---------------	--------------	--------------

Diffuse reflective background suppression

Operating frequency		Door mode 16.7 Hz Industri mode 250 Hz	1000 Hz	1000 Hz
Sensing distance (Sn)		2.5 m, adjustable	150 mm, adjustable	150 mm, adjustable
Cable		2 m	2 m	2 m
NPN/PNP, NO+NC		-	PA15INPA/PA15IPPA	PB15INPA/PB15IPPA
NPN+PNP, NO/NC		PD112CNB25BP	-	-
Connector		M12	M12	M12
NPN/PNP, NO+NC		-	PA15INPA-1/PA15IPPA-1	PB15INPA-1/PB15IPPA-1
NPN+PNP, NO/NC		PD112CNB25BPM1		

Retro reflective polarized

Operating frequency			1000 Hz	1000 Hz
Sensing distance (Sn)			3 m, adjustable	3 m, adjustable
Cable			2 m	2 m
NPN/PNP, NO+NC			PA3PNPA/PA3PPPA	PB3PNPA/PB3PPPA
Connector			M12	M12
NPN/PNP, NO+NC			PA3PNPA-1/PA3PPPA-1	PB3PNPA-1/PB3PPPA-1

Through-beam



Operating frequency	100 Hz			
Sensing distance (Sn)	12 m, adjustable			
Cable	2 m			
NPN NO (Receiver)	PD70CNT12NO			
NPN NC (Receiver)	PD70CNT12NC			
PNP NO (Receiver)	PD70CNT12PO			
PNP NC (Receiver)	PD70CNT12PC			
Mute High (Emitter)	PD70CNT12MH			
Mute Low (Emitter)	PD70CNT12ML			
Connector	M8			
NPN NO (Receiver)	PD70CNT12NOM5			
NPN NC (Receiver)	PD70CNT12NCM5			
PNP NO (Receiver)	PD70CNT12POM5			
PNP NC (Receiver)	PD70CNT12PCM5			
Mute High (Emitter)	PD70CNT12M5MH			
Mute Low (Emitter)	PD70CNT12M5ML			

Specifications

Rated operating voltage	10 - 30 VDC	10 - 30 VDC	10 - 30 VDC	10 - 30 VDC
Voltage drop	≤ 1.8 VDC	≤ 2.5 VDC	≤ 2.5 VDC	≤ 2.5 VDC
Degree of protection	IP 67	IP 67	IP 67	IP 67
Protection Short-circuit (S)				
Reverse polarity (P)	SPT	SPT	SPT	SPT
Transients (T)				
Load current	≤ 100 mA	< 200 mA	< 200 mA	< 200 mA
Housing material	PC Black	PC Black	Aluminium	Reinforced ABS
Operating temperature	-25°C to +55°C	-25°C to +55°C	-25°C to +60°C	-25°C to +60°C
LED colour	Yellow, Receiver output Green, Emitter power ON	Yellow, Output Green, Power ON	Yellow	Yellow
Approvals/Marks	CE - cURus	CE - cULus	CE	CE

Photoelectric sensors

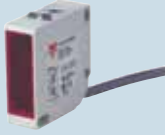
Integrated amplifier

Types	PC50	PC50..M1	PC50
Connections	2 m cable	M12 connector	2 m cable
			
Dimensions (mm)	17 x 50 x 50	17 x 50 x 50	17 x 50 x 50
Diffuse reflective			
Operating frequency	500 Hz	500 Hz	20 Hz
Sensing distance (Sn)	1 m, adjustable	1 m, adjustable	
NPN/PNP NO+NC	PC50CND10BA	PC50CND10BAM1	
Sensing distance (Sn)	2 m, adjustable	2 m, adjustable	
NPN/PNP NO+NC	PC50CND20BA	PC50CND20BAM1	
Sensing distance (Sn)			1 m, adjustable
Relay SPDT Multivoltage			PC50CND10RP
Sensing distance (Sn)			2 m, adjustable
Relay SPDT Multivoltage			PC50CND20RP
Diffuse reflective background suppression			
Operating frequency	250 Hz	250 Hz	
Sensing distance (Sn)	500 mm, adjustable	500 mm, adjustable	
NPN/PNP NO+NC	PC50CNB50BA	PC50CNB50BAM1	
Retro reflective polarized			
Operating frequency	500 Hz	500 Hz	20 Hz
Sensing distance (Sn)	6 m, adjustable	6 m, adjustable	6 m, adjustable
NPN/PNP NO+NC	PC50CNP06BA	PC50CNP06BAM1	
Mute High	PC50CNP06BAMH	PC50CNP06BAM1MH	
Mute Low	PC50CNP06BAML	PC50CNP06BAM1ML	
Relay SPDT Multivoltage			PC50CNP06RP
Retro reflective			
Operating frequency	500 Hz	500 Hz	20 Hz
Sensing distance (Sn)	10 m, adjustable	10 m, adjustable	10 m, adjustable
NPN/PNP NO+NC	PC50CNR10BA	PC50CNR10BAM1	
Relay SPDT Multivoltage			PC50CNR10RP
Through-beam emitter			
Sensing distance (Sn)	20 m	20 m	20 m
	PC50CNT20B	PC50CNT20BM1	PC50CNT20R
Through-beam receiver			
Operating frequency	500 Hz	500 Hz	20 Hz
Sensing distance (Sn)	20 m, adjustable	20 m, adjustable	20 m, adjustable
NPN/PNP NO+NC	PC50CNT20BA	PC50CNT20BAM1	-
Relay SPDT Multivoltage			PC50CNT20RP
Specifications			
Rated operating voltage	10 - 30 VDC	10 - 30 VDC	12 - 240 VDC / 24 - 240 VAC
Voltage drop	≤ 2.5 VDC	≤ 2.5 VDC	Relay SPDT
Degree of protection	IP 67	IP 67	IP 67
Protection Short-circuit (S)			
Reverse polarity (P)	SPT	SPT	PT
Transients (T)			
Load current	≤ 200 mA	≤ 200 mA	≤ 3 mA
Housing material	Reinforced ABS/PC	Reinforced ABS/PC	Reinforced ABS/PC
Operating temperature	-20°C to +60°C	-20°C to +60°C	-20°C to +60°C
LED colour	Yellow + Green	Yellow + Green	Yellow + Green
Approvals/Marks	CE - UL - CSA	CE - UL - CSA	CE - UL - CSA

Photoelectric sensors

Integrated amplifier colour sensors

Types	PD12CNC..BPT
Connections	M12 connector



Dimensions (mm)	61 x 26 x 115
------------------------	----------------------

Diffuse reflective

Operating frequency	500 Hz
Sensing distance (Sn)	2 to 60 mm (fiber depend.)
NPN/PNP NO+PC	PD12CNC01BPM1T 1 Output
NPN/PNP NO+PC	PD12CNC04BPM1T 4 Output





Accessories: fibres

Dist. 18 mm	FPDC 01 SCC 100
Dist. 40-60 mm	FPDC 02 SCC 100
Dist. 4-6 mm	FPDC 03 SCC 100
Dist. 2-6 mm	FPDC 04 SCC 100
Dist. 4 mm	FPDC 05 SCC 100





General specifications

Rated operating voltage	24 VDC
Voltage drop	≤ 2.2 VDC
Degree of protection	IP 65
Protection Short-circuit (S) Reverse polarity (P) Transients (T)	SPT
Load current	< 100 mA
Housing material	Polycarbonate
Operating temperature	0°C to +40°C
LED colour	Yellow + Green
Approvals/Marks	CE - cUL

Photoelectric sensors



	Integrated amplifier		Fork sensor	
Types	PD60..	PD60..M5	PF80..	PF74..
Connections	2 m cable	M8 connector	M8 connector	5 m cable
				
Dimensions (mm)	13 x 30 x 60	13 x 30 x 60	12 x 37.5 x 80	15 x 60 x 74
Transparent detection				
Operating frequency	1000 Hz	1000 Hz		
Sensing distance (Sn)	0.8 m, Teach-in	0.8 m, Teach-in		
NPN/PNP NO+NC	PD60CNG08BPT	PD60CNG08BPM5T		
Sensing distance (Sn)	1.4 m, Teach-in	1.4 m, Teach-in		
NPN/PNP NO+NC	PD60CNG14BPT	PD60CNG14BPM5T		
Fibre optical sensor plastic fibres				
Operating frequency	1000 Hz	1000 Hz		
Sensing distance (Sn)	200 mm	200 mm		
NPN/PNP NO+NC	PD60CNX20BP	PD60CNX20BPM5		
Sensing distance (Sn)	200 mm, Teach-in	200 mm, Teach-in		
NPN/PNP NO+NC	PD60CNX20BPT	PD60CNX20BPM5T		
Fibre optical sensor glass fibres				
Operating frequency	1000 Hz	1000 Hz		
Sensing distance (Sn)	200 mm	200 mm		
NPN/PNP NO+NC	PD60CNV20BP	PD60CNV20BPM5		
Sensing distance (Sn)	200 mm, Teach-in	200 mm, Teach-in		
NPN/PNP NO+NC	PD60CNV20BPT	PD60CNV20BPM5T		
Contrast sensor				
Operating frequency	20 kHz	20 kHz		
Sensing distance (Sn)	18 mm (fibre depend.)	18 mm (fibre depend.)		
NPN/PNP NO+NC	PD60CNK18BPT	PD60CNK18BPM5T		
Fork sensor				
Operating frequency			10 kHz	≤ 1100 Hz
Sensing distance (Sn)			3 mm, slot width	30 mm, slot width
NPN/PNP NO+NC			PF80FNT03BPM5T	
PNP N.O., NPN N.C.				PF74CNT30BC
PNP N.C., NPN N.O.				PF74CNT30BO
General specifications				
Rated operating voltage	10 - 30 VDC	10 - 30 VDC	10 - 30 VDC	19.2 - 28.8 VDC
Voltage drop	≤ 2.0 VDC	≤ 2.0 VDC	≤ 2.0 VDC @ 100 mA ≤ 1.0 VDC @ 10 mA	≤ 1.5 VDC @ 100 mA
Degree of protection	IP 65 (IP 67 CNG type)	IP 65 (IP 67 CNG type)	IP 65	IP 65
Protection Short-circuit (S)				
Reverse polarity (P)	SPT	SPT	ST	SPT
Transients (T)				
Load current	≤ 100 mA	≤ 100 mA	≤ 40 mA	≤ 30 mA
Housing material	PC	PC	Aluminium, black	PC, black
Operating temperature	0°C to +60°C	0°C to +60°C	-20°C to +60°C	-25°C to +60°C
LED colour	Red	Red	Yellow + Red	Yellow + Green
Approvals/Marks	CE - UL - cUL	CE - UL - cUL	CE	CE

Photoelectric sensors

	Integrated amplifier relay output			Through-beam relay output
Types	PM..	PM..	PD86	PD98
Connections	Terminals single relay	Terminal block mute input	Terminal block mute input	Terminal block mute input
				
Dimensions (mm)	25 x 65 x 81	25 x 65 x 81	86 x 44 x 39	98 x 56 x 37
Diffuse reflective				
Oper. freq. / Sens. dist. (Sn)	20 Hz			
Sensing distance (Sn)	0.8 m, adjustable			
Relay SPDT Multivoltage	PMD8RG / RGT PMD8RI / RIT			
Retro reflective polarized				
Oper. freq. / Sens. dist. (Sn)	20 Hz / 12 m, fixed	20 Hz / 12 m, fixed	20 Hz / 12 m, fixed	
Relay SPDT Multivoltage	PMP12RG / PMP12RI		PD86CNP12QPMU	
Relay SPST (PC)			PMP12RGM / PMP12RIM	
Relay SPST (ZAMAK)			PD86HNP12QPMU-01C	
Retro reflective				
Oper. freq. / Sens. dist. (Sn)	20 Hz / 10 m, fixed			
Relay SPDT Multivoltage	PMR10RG / RGT			
Relay SPST	PMR10RI / RIT			
Through-beam emitter				
Sensing distance (Sn)	20 m	20 m	30 m (15 m default)	
	PMT20G / PMT20I	PMT20GM / PMT20IM	PD98CNT30QMU*	
Through-beam receiver				
Oper. freq. / Sens. dist. (Sn)	20 Hz / 20 m, fixed	20 Hz / 20 m, fixed	25 Hz / 30 m (15 m default)	
Relay SPDT Multivoltage	PMT20RG / RGT PMT20RI / RIT			
Relay SPST				
General specifications				
Rated operating voltage	12 - 240 VDC / 24 - 240 VAC	24 VAC/DC ±20%	24 VAC/DC ±20%	12 V to 24 VAC/DC
Voltage drop	Relay SPDT	Relay SPST	Relay SPST	Relay DPDT
Degree of protection	IP 67	IP 67	IP 66	IP 54
Protection Short-circuit (S)				
Reverse polarity (P)	PT	PT	PT	PT
Transients (T)				
Load current	≤ 3 A	≤ 3 A	1 A (AC), 0.5 A (DC)	1 A (AC), 0.5 A (DC)
Housing material	PC/ABS	PC/ABS	PD86C.. : PC + PMMA PD86H.. : ZAMAK + PMMA	PC/ABS
Operating temperature	-25°C to +55°C	-25°C to +55°C	-25°C to +60°C	-25°C to +60°C
LED colour	Yellow	Yellow	Yellow + Green	Yellow (receiver)
Approvals/Marks	CE - UL - CSA	CE - UL325 - UL508	CE - UL325 - UL508	CE - UL325
Remarks	G = PG 13.5 Outlet I = ½"NPT Outlet T = Timer	G = PG 13.5 Outlet I = ½"NPT Outlet Mute input	Mute input	Mute input

* Item number set, emitter + receiver.

Photoelectric sensors

	Heavy duty infrared barrier	Through-beam relay output
Types	PD140	PD180
Connections	Terminal block	Terminal block
		
Dimensions (mm)	140 x 51 x 46	180 x 51 x 49
Through-beam range		
Indoor sensing distance (max)	60 m outdoor	15 / 30 m
General specifications		
Technology	Infrared	Infrared
Supply voltage Receiver or Emitter	12...24 VAC/VDC	12 + 24 VAC/DC
Battery Supply Emitter		2 x 3,6 VDC, 2100 mAh Lithium Batteries size AA
Consumption	155 mA to 24 VAC (Emitter and receiver)	35 mA DC (55 mA DC with low battery alarm)
Output	SPDT	2 x SPST
Contact rating	1 A /@ 30 VDC, 0.5 A @ 50 VAC (resistive load)	1 A @ 30 VDC (resistive load)
Approvals	CE - UL325 - UL508	CE - UL325
Conformity	EN 12445, EN 12453, EN12978, EN/ISO 13849-1 ESPE2, RoHS	EN 12445, EN12453, EN12978, RoHS
Test input	Emitter test input	Emitter test input
Environmental specifications		
Wavelength	850 nm	850 nm
Operating temperature	-20°C to +60°C	-25°C to +55°C
Degree of protection	IP 65	IP 55
Mechanical specifications		
LED transmitter	Power signal	None (energy saving)
LED receiver	Signal for alignment with transmitter	Power ON - Green LED Output - Yellow LED
Optical adjustment	Horizontal 200° Vertical ±15°	Horizontal 200° Vertical ±30°
Mounting	Wall mounted type	Wall mounted type
Material	Aluminium, PC	PC
Weight	460 g (set)	Emitter 270g Receiver 230g
Comments	ESPE Category 2, EN 61496-2 Accessory: Laser alignment tool	Emitter is supplied with 2 x 3.6 VDC 2100 mAh Lithium Batteries
Accessories	APD140-LA01 APD140-LA02 APD140-TC01	

Photoelectric sensors

	Sensors	Amplifier 1-channel	Amplifier 2-channel	Amplifier 3-channel
Types	MPF..	MPF1..	MPF2..	MPF3..
Connections	10 m cable	Terminals	Terminals	Terminals



Dimensions (mm)	See sensor type	70 x 57 x 86	70 x 57 x 86	70 x 57 x 86
-----------------	-----------------	--------------	--------------	--------------

Amplifier	1-Channel	2-Channel	3-Channel
	12-24 VAC/DC ±15% Low current	MPF1-912RSL	MPF2-912RSL
12-24 VAC/DC ±15%	MPF1-912RS	MPF2-912RS	MPF3-912RS
115 VAC ±15%	MPF1-115RS	MPF2-115RS	MPF3-115RS
230 VAC ±15%	MPF1-230RS	MPF2-230RS	MPF3-230RS





Through-beam emitter	Output and function selection			
	No Dist Adjust		Dist Adjust	
Sensing distance (Sn)	15 m			
Ø12 x 20	MPFT15-4 (C)		Normal Mute	Inverted Mute
D11 x 24.5	MPFT15-D11-4			
D18 x 25	MPFT15-D18-4 (C)	RS	RSI	RSA
M14 x 23	MPFT15-M14-4 (C)	RSL	RSLI	RSLA

Through-beam receiver	
Sensing distance (Sn)	15 m
Ø12 x 20	MPFR-4 (C)
D11 x 24.5	MPFR-D11-4
D18 x 25	MPFR-D18-4 (C)
M14 x 23	MPFR-M14-4 (C)

General specifications				
Rated operating voltage	Powered by amplifier	See amplifier reference	See amplifier reference	See amplifier reference
Output		1 x 2 SPST in series	2 x 2 SPST in series	3 x 2 SPST in series
Low current resistive load		RS type: 2 A @ 240 VAC / 30 VDC RSL type: 0.5 A @ 50 VAC / 30 VAC	RS type: 2 A @ 240 VAC / 30 VDC RSL type: 0.5 A @ 50 VAC / 30 VAC	RS type: 2 A @ 240 VAC / 30 VDC RSL type: 0.5 A @ 50 VAC / 30 VAC
Operating frequency	Amplifier dependent	10 Hz	10 Hz	10 Hz
Degree of protection	IP 67	IP 40	IP 40	IP 40
Protection Short-circuit (S) Reverse polarity (P) Transients (T)	SPT	PT	PT	PT
Housing material		PC	PC	PC
-Amplifier				
-Sensor Ø12+D11+D18	PC + ABS			
-Sensor	PC + Stainless steel			
Operating temperature	-20°C to +60°C	-20°C to +60°C	-20°C to +60°C	-20°C to +60°C
LED colour		Yellow	Yellow	Yellow
Approvals/Marks	CE - UL325 - UL508	CE - UL325 - UL508	CE - UL325 - UL508	CE - UL325 - UL508
Remarks	C = Pigtail connector version			
Optical angle (degrees)	±5			

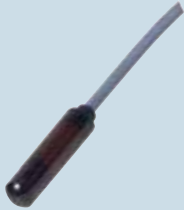
Photoelectric sensors

Sensors for amplifiers

Types	MOF..	MOF.. ATEX	MNF..	MDF..
Connections	10 m cable	Terminals	Terminals	Terminals
				
Dimensions (mm)	Ø 10 x 42	Ø 10 x 42	Ø 20 x 80	Ø 13.5 x 55
Through-beam emitter				
Sensing distance (Sn)	20 m	20 m		
Max. ±2° optical angle	MOFT20 MOFT20-M12-2	MOFT20AX MOFT20-M12-2AX		
Sensing distance (Sn)	50 m			
Max. ±2° optical angle	MOFT50 MOFT50-M12-2			
Sensing distance (Sn)	20 m	20 m		
Max. ±5° optical angle	MOFT20-5 MOFT20-M12-5	MOFT20-5AX MOFT20-M12-5AX		
Sensing distance (Sn)	20 m	20 m	15 m	30 m
Max. ±8° optical angle	MOFT20-8 MOFT20-M12-8 MOFT20-M14-8	MOFT20-8AX MOFT20-M12-8AX MOFT20-M14-8AX	MNFT15	MDFT30
Through-beam receiver				
Operating frequency	Amplifier dependent	Amplifier dependent	Amplifier dependent	Amplifier dependent
Sensing distance (Sn)	See emitter	See emitter	See emitter	See emitter
Max. ±2° optical angle	MOFR MOFR-M12-2	MOFRAX MOFR-M12-2AX		
Max. ±5° optical angle	MOFR-5 MOFR-M12-5	MOFR-5AX MOFR-M12-5AX		
Max. ±8° optical angle	MOFR-8 MOFR-M12-8 MOFR-M14-8	MOFR-8AX MOFR-M12-8AX MOFR-M14-8AX	MNFR15	MDFR30
General specifications				
Rated operating voltage	Powered by Amplifier	Powered by Amplifier	Powered by Amplifier	Powered by Amplifier
Output	On Amplifier	On Amplifier	On Amplifier	On Amplifier
Operating frequency	See Amplifier type: S142.. - S143.. - PAM..	See Amplifier type: S142.. - S143.. - PAM..	See Amplifier type: S142.. - S143.. - PAM..	See Amplifier type: S142.. - S143.. - PAM..
Degree of protection	IP 66 - IP 67	IP 66 - IP 67	IP 67	IP 67
Protection Short-circuit (S)				
Reverse polarity (P)	SPT	SPT	SPT	SPT
Transients (T)				
Housing material sensor	Ø10: PC M14 + M14: PC + SS	Ø10: PC M14 + M14: PC + SS	PC M14 + M14: PC + SS	Acetal, glass reinforced
Operating temperature	-20°C to +60°C	-20°C to +60°C	-20°C to +60°C	-20°C to +60°C
LED colour	None	None	None	None
Approvals/Marks	CE	CE - ATEX	CE	CE

Photoelectric sensors

Types

Amplifiers for sensors

Connections

11-pole plug

11-pole plug

11-pole plug



Dimensions (mm)	35 x 80 x 81.5	35 x 80 x 81.5	35 x 80 x 81.5
Description	Standard amplifier with Sensor diagnostics and adjustable sensing distance	As S142A but with adjustable time delay	As S142A but with Master / Slave function for high neighbour immunity





References amplifier

1 x SPDT relay	S142ARNN924	S142BRNN924	
1 x NPN Output	S142ARNN024	S142BRNN024	
1 x NPN Alarm Output	S142ARNN115 S142ARNN230	S142BRNN115 S142BRNN230	
1 x SPDT relay	S142ARNT924	S142BRNT924	
1 x NPN Output or alarm	S142ARNT024		
1 x Emitter mute input	S142ARNT115 S142ARNT230	S142BRNT115 S142BRNT230	
1 x PNP Output	S142APPT924	S142BPPT924	
1 x PNP Alarm Output	S142APPT115	S142BPPT115	
1 x Emitter mute input	S142APPT230	S142BPPT230	
1 x SPDT relay			S142CRXA924
A - Auto distance adjustment			S142CRXA115 S142CRXA230
M - Manual distance adjustment			S142CRXM924 S142CRXM115 S142CRXM230



General specifications

Rated operating voltage			
924	24 VAC/DC	24 VAC/DC	24 VAC/DC
115	115 VAC	115 VAC	115 VAC
230	230 VAC	230 VAC	230 VAC
Relay load current resistive load	10 A @ 250 VAC / 25 VDC SPD	10 A @ 250 VAC / 25 VDC SPD	10 A @ 250 VAC / 25 VDC SPD
Transistor Load current	100 mA 40 VDC	100 mA 40 VDC	
Operation frequency	20 Hz	20 Hz, no timer	15 Hz @ 2 systems 4 Hz @ 6 systems
Degree of protection	IP 20	IP 20	IP 20
Protection Short-circuit (S)			
Reverse polarity (P)	SPT	SPT	S
Transients (T)			
Housing material	Noryl SE1, Light grey	Noryl SE1, Light grey	Noryl SE1, Light grey
Operating temperature	-20°C to +50°C	-20°C to +50°C	-20°C to +50°C
Approvals/Marks	CE - UL - CSA	CE - UL - CSA	CE - UL - CSA

Photoelectric sensors

Types	S1430 UAP..	S1430 RAL..	S1430 ROS..	PAM...
Connections	1 1-pole plug	11-pole plug	11-pole plug	Terminals
				
Dimensions (mm)	35 x 80 x 81.5	35 x 80 x 81.5	35 x 80 x 81.5	2, 3, 4, 5, 6 DIN housing
Description	3 input 3 transistors outputs	3 input 3 transistors outputs	3 input 3 double relay outputs	2-4-6-8 or 10 channel modular system
References amplifier				
12-30 VAC/DC $\pm 15\%$	S1430UAP912			
15-30 VAC/DC $\pm 10\%$		S1430RAL915	S1430ROS915	
No. of channels				2 channels
- NPN output, NO				PAM02AN3ANO/NC
- PNP output, NO				PAM02AN3APO/PC
No. of channels				4 channels
- NPN output, NO				PAM04AN3ANO/NC
- PNP output, NO				PAM04AN3APO/PC
No. of channels				6 channels
- NPN output, NO				PAM06AN3ANO/NC
- PNP output, NO				PAM06AN3APO/PC
References extension modules				
No. of channels				2 channels
- NPN output, NO				PAM02CN3ANO
- NPN output, NC				PAM02CN3ANC
- PNP output, NO				PAM02CN3APO
- PNP output, NC				PAM02CN3APC
No. of channels				4 channels
- NPN output, NO				PAM04CN3ANO
- NPN output, NC				PAM04CN3ANC
- PNP output, NO				PAM04CN3APO
- PNP output, NC				PAM04CN3APC
General specifications				
Rated operating voltage	See Amplifier type	See Amplifier type	See Amplifier type	18 - 33 VDC
Output	3 x Transistor NPN/PNP/NO/NC	3 x SPST	3 x SPST	One output per channel
Load current resistive load	100 mA, 40 VDC, NPN	1.5 A @ 100 VAC / 30 VDC	1.5 A @ 100 VAC / 30 VDC	20 mA, 33 VDC, NPN / PNP 8 A @ 250 VAC / 24 VDC SPDT resistive load
Operation frequency	16 Hz	12.5 Hz	12.5 Hz	30 Hz @ 6 channels
Degree of protection	IP 20	IP 20	IP 20	IP 20
Protection Short-circuit (S)				
Reverse polarity (P)	SPT	PT	PT	SPT
Transients (T)				
Housing material	Noryl SE1, Light grey	Noryl SE1, Light grey	Noryl SE1, Light grey	
Operating temperature	-20°C to +50°C	-20°C to +50°C	-20°C to +50°C	-20°C to +50°C
LED colour	Yellow + Green + Red	Yellow + Green + Red	Yellow + Green + Red	Yellow + Green + Red
Approvals/Marks	Multiplexed system	Multiplexed system	Multiplexed system	Multiplexed system, Test functions, bargraph, mute input etc.

Photoelectric sensors

Types	Wireless entrapment protection device for industrial doors ESPE		
Connections	Main controller	Subcontroller	PB 11
			
Dimensions (mm)	35 x 35 x 125	26 x 242 x 45	Ø11 x 24.5
Description	The Carlo Gavazzi main controller can control up to 4 subcontrollers	This flexible Carlo Gavazzi subcontroller can handle 2 safety edges and 1 door-in-door limit switch	
References			
Main controller	WSM 2 B A 2 D24		
Subcontroller	WSS 2 B A 2 BAT		
Photoelectric sensor Emitter	PB 11 CNT 15 WE		
Photoelectric sensor Receiver	PB 11 CNT 15 WR		
General specifications			
Rated operating voltage	12 - 24 VAC/DC	1 - 4 Lithium 3.6 VDC size AA batteries	From sub controller
Supply current	< 50 mA		
Relay load current resistive load	1A / 30 VDC 0.5 A / 30 VAC		
Communication frequency	2.4 GHz Duplex	2.4 GHz Duplex	
Response time	120 mS	120 mS	
Number of channels	16	16	
Communication distance	10 m wireless	10 m wireless	
Sensing distance			15 m
Subcontroller up-time		10 - 80 sec	
Test input	On main module		
Degree of protection	IP 66	IP 66	IP 67
Protection Short-circuit (S) Reverse polarity (P) Transients (T)	PT	P	
Housing material	ABS, Light grey	PC, Light grey	PA6 Glass reinforced
Operating temperature	-25°C to +55°C	-25°C to +55°C	-25°C to +55°C
LED colour	Green, Yellow, Red	Yellow	-
Approvals/Marks	CE - UL - FCC	CE - UL - FCC	CE - UL

Photoelectric sensors

Types **Wireless entrapment protection device for industrial gates ESPE**

Connections **Main controller Subcontroller PB 11**



Dimensions (mm) 35 x 35 x 125 26 x 242 x 45 Ø11 x 24.5

Description The Carlo Gavazzi main controller can control up to 6 subcontrollers This flexible Carlo Gavazzi subcontroller can handle one opening safety edge and one closing edge



References

Main controller (N.O. 8.2 kohm output)	WSM6GAOOD24		
Main controller (N.C. output)	WSM6GACCD24		
Subcontroller		WSS2GA2BAT	
Photoelectric sensor Emitter			PB 11 CNT 15 WE
Photoelectric sensor Receiver			PB 11 CNT 15 WR

General specifications

Rated operating voltage	12 - 24 VAC/DC	1 - 4 Lithium 3.6 VDC size AA batteries	From sub controller
Supply current	< 50 mA		
Relay load current resistive load	1A / 30 VDC 0.5 A / 30 VAC		
Communication frequency	2.4 GHz Duplex	2.4 GHz Duplex	
Response time	From 15 to 100 ms	From 15 to 100 ms	
Number of channels	16	16	
Communication distance	15 m wireless	15 m wireless	
Sensing distance			2.5 m
Subcontroller up-time		15 – 105 s, fixed time or infinite	
Test input	On main module		
Degree of protection	IP 66	IP 66	IP 67
Protection Short-circuit (S)			
Reverse polarity (P)	PT	P	
Transients (T)			
Housing material	ABS, Light grey	PC, Light grey	PA6 Glass reinforced
Operating temperature	-25°C to +55°C	-25°C to +55°C	-25°C to +55°C
LED colour	Green, Yellow, Red	Yellow	-
Approvals/Marks	CE - UL - FCC - TÜV	CE - UL - FCC - TÜV	CE - UL

Photoelectric level sensors

Integrated amplifier			
Types	VPO.E.	VP ATEX	VP E.M
Connections	2 m cable	2 m cable	2 m cable
			
Dimensions (mm)	3/8" x 74	3/8" x 74	3/8" x 74
Light type	Unmodulated	Unmodulated	Unmodulated
References optical level sensor			
Operating frequency	30 Hz	30 Hz	30 Hz
Sensing dist. (Sn), Hor.	± 5 mm, fixed	± 5 mm, fixed	± 5 mm, fixed
Sensing dist. (Sn), Ver.	± 2.5 mm, fixed	± 2.5 mm, fixed	± 2.5 mm, fixed
Housing material	Polysulphone	Polysulphone	Polysulphone
NPN NO	VP02E		VP02EM
NPN NC	VP01E		VP01EM
PNP NO	VP02EP	VP02EPAX	VP02EPM
PNP NC	VP01EP	VP01EPAX	VP01EPM
Housing material	Polyamide 12	Polyamide 12	Polyamide 12
NPN NO	VP04E		VP04EM
NPN NC	VP03E		VP03EM
PNP NO	VP04EP	VP04EPAX	VP04EPM
PNP NC	VP03EP	VP03EPAX	VP03EPM
Housing material	Polysulphone		
SCR NO	VP02-110TB		
SCR NC	VP01-110TB		
SCR NO	VP02-230TB		
SCR NC	VP01-230TB		
DC-types			
Rated operating voltage	10 - 40 VDC	10 - 40 VDC	10 - 40 VDC
Voltage drop	≤ 1.0 VDC	≤ 1.0 VDC	≤ 1.0 VDC
Off-state current	≤ 12 mA	≤ 12 mA	≤ 12 mA
Load current	< 200 mA	< 200 mA	< 200 mA
AC-types (SCR)			
Rated operating voltage	110 or 230 VAC	110 or 230 VAC	110 or 230 VAC
Voltage drop	≤ 9 VAC	≤ 9 VAC	≤ 9 VAC
Off-state current	≤ 7 mA	≤ 7 mA	≤ 7 mA
Load current	< 10 - 100 mA	< 10 - 100 mA	< 10 - 100 mA
AC-types (SCR)			
Degree of protection	IP 67	IP 67	IP 67
Protection Short-circuit (S)			
Reverse polarity (P)	PT	PT	PT
Transients (T)			
Operating temperature	-20°C to +80°C	-20°C to +80°C	-20°C to +80°C
LED colour	Yellow	Yellow	Yellow
Pressure	10 bar @ +60°C	10 bar @ +60°C	10 bar @ +60°C
Approvals/Marks	CE - UL - CSA	CE - UL - CSA	CE - UL - CSA

Photoelectric level sensors

Integrated amplifier

Types	VPA..../VPB....	VPA....-1/VPB....-1
Connections	2 m cable	M12 connector

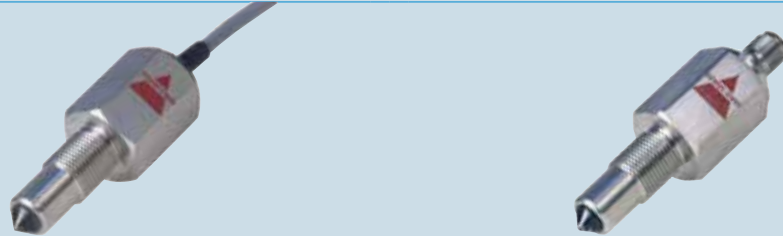

Dimensions (mm)	3/8" x 70.5	3/8" x 90.5
Light type	Modulated	Modulated

References optical level sensor

Operating frequency	30 Hz	30 Hz
Sensing dist. (Sn), Hor.	± 5 mm, fixed	± 5 mm, fixed
Sensing dist. (Sn), Ver.	± 2.5 mm, fixed	± 2.5 mm, fixed
Housing material	Stainless steel/polysulphone	Stainless steel/polysulphone
NPN NO+NC	VPA1MNA	VPA1MNA-1
PNP NO+NC	VPA1MPA	VPA1MPA-1
Housing material	Stainless steel and glass	Stainless steel and glass
NPN NO+NC	VPA2MNA	VPA2MNA-1
PNP NO+NC	VPA2MPA	VPA2MPA-1
Housing material	Nickel-pl. brass/polysulphone	Nickel-pl. brass/polysulphone
NPN NO+NC	VPB1MNA	VPB1MNA-1
PNP NO+NC	VPB1MPA	VPB1MPA-1
Housing material	Nickel-plated brass and glass	Nickel-plated brass and glass
NPN NO+NC	VPB2MNA	VPB2MNA-1
PNP NO+NC	VPB2MPA	VPB2MPA-1

DC-types

Rated operational voltage	10 - 40 VDC	10 - 40 VDC
Voltage drop	≤ 2.5 VDC	≤ 2.5 VDC
Off-state current	≤ 7 mA	≤ 7 mA
Load current	< 200 mA	< 200 mA

General specifications

Degree of protection	IP 67	IP 67
Protection Short-circuit (S)		
Reverse polarity (P)	SPT	SPT
Transients (T)		
Operating temperature	-20°C to +80°C	-20°C to +80°C
LED colour	Yellow	No LED
Pressure	10 bar @ +60°C	10 bar @ +60°C
Approvals/Marks	CE - UL - CSA	CE - UL - CSA

Photoelectric sensors accessories

Reflectors, rectangular



Item Number	ER100	ER840	ER681	ER686
Dimensions (mm)	100 x 100 x 9.2	84.5 x 84.5 x 9	52 x 119 x 27	55.3 x 126 x 9
Mounting (screws not incl.)	2 x M3 screws	2 x M3.5 screws	4 x M4 screws	2 x M6 screws
Reduction factor	1.2	0.96	0.92	0.92

Reflectors, rectangular



Item Number	ER4060	ER5060	ER42182	ER5080
Dimensions (mm)	60 x 41 x 8	55.5 x 61 x 8	186 x 46.5 x 8	80 x 54 x 8
Mounting (screws not incl.)	2 x M3.5 screws	2 x M4 screws	2 x M6 screws	Adhesive
Reduction factor	0.81	0.80	0.65	0.60

Reflectors, rectangular

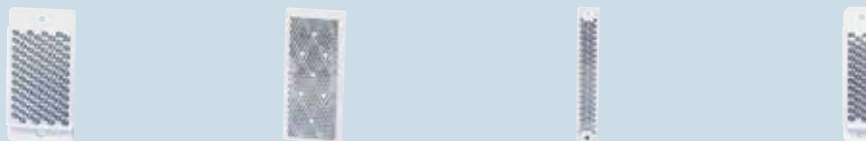

Item Number	ER483	ER8	ER665	ER530
Dimensions (mm)	32.5 x 65 x 8	82 x 37 x 5.5	18.5 x 120 x 65	19 x 72.5 x 8.4
Mounting (screws not incl.)	2 x M3.5 screws	Adhesive	2 x M4 screws	2 x M3.5 screws
Reduction factor	0.55	0.51	0.45	0.45

Reflectors, rectangular

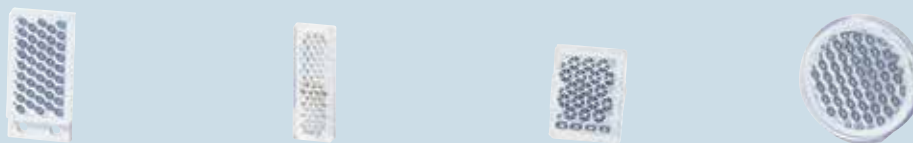

Item Number	ER390	ER1	ER640	ER692
Dimensions (mm)	23.5 x 47.5 x 8	51 x 17.5 x 5	13 x 17 x 5	Ø 35 x 5.5
Mounting (screws not incl.)	2 x M3.5 screws	Adhesive	Adhesive	Adhesive
Reduction factor	1.39	0.20	0.16	0.53

Reflectors, cylindrical

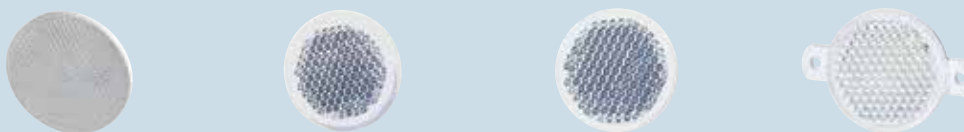

Item Number	ER4	ER460	ER420	ER423
Dimensions (mm)	Ø 84 x 7.4	Ø 46 x 6.5	Ø 42 x 6.3	Ø 41.5 x 6
Mounting (screws not incl.)	1 x M4 screw	Adhesive	Adhesive	2 x M3 screws
Reduction factor	1	0.55	0.54	0.54

Photoelectric sensors accessories

Reflectors, cylindrical



Item Number	ER689
Dimensions (mm)	Ø 25 x 5.5
Mounting (screws not incl.)	Adhesive
Reduction factor	0.39

Micro cube reflectors for LD32



Item Number	EM 130-20
Dimensions (mm)	20 x 43
Mounting (screws not incl.)	2 x M3 screws
Reduction factor	1 (Micro Cube)



Item Number	EM 120-20
Dimensions (mm)	20 x 32
Mounting (screws not incl.)	2 x M3.5 screws
Reduction factor	1 (Micro Cube)



Item Number	EM 123-70
Dimensions (mm)	13.7 x 23
Mounting (screws not incl.)	2 x M2 screws
Reduction factor	1 (Micro Cube)

Reflectors, tape



Item Number	ERT25
Dimensions (mm)	25 mm x 45.7 m
Mounting (screws not incl.)	Adhesive
Reduction factor	0.23 (25 x 25 mm)



Item Number	EM 111-40
Dimensions (mm)	10.5 x 10.5
Mounting (screws not incl.)	Adhesive
Reduction factor	1 (Micro Cube)



Item Number	EM 121-41
Dimensions (mm)	Ø20
Mounting (screws not incl.)	Adhesive
Reduction factor	1 (Micro Cube)



Item Number	EM 110-40
Dimensions (mm)	Ø10
Mounting (screws not incl.)	Adhesive
Reduction factor	1 (Micro Cube)

Reflectors, tape



Item Number	ERT50
Dimensions (mm)/Used for	50 mm x 45.7 m
Mounting (screws not incl.)	Adhesive
Reduction factor/Description	0.34 (50 x 50 mm)



Item Number	AMPF-MB1
Dimensions (mm)/Used for	MPFT15-4 & MPFR-4
Mounting (screws not incl.)	Adhesive
Reduction factor/Description	Plastic mounting bracket for wall mounting



Item Number	AMPF-MB2
Dimensions (mm)/Used for	MPFT15-4 & MPFR-4
Mounting (screws not incl.)	Adhesive
Reduction factor/Description	Adaptor for fitting to an Ø18 mm rubber profile



Item Number	AMPF-MB3
Dimensions (mm)/Used for	MPFT15-4 & MPFR-4
Mounting (screws not incl.)	Adhesive
Reduction factor/Description	Metal mounting bracket for harsh environment

Accessories, photoelectric sensors

Accessories, photoelectric sensors



Item Number	APA18-AK
Used for	M18 photoelectrics
Description	Ø2, Ø4, and Ø8 mm aperture



Item Number	APA18-RAR
Used for	M18 photoelectrics
Description	90° mirror for angle detection



Item Number	6IODC
Used for	S1430...
Description	Plug conversion



Item Number	APA3
Used for	PA.. sensors
Description	Mounting bracket in anodized aluminium

Accessories, photoelectric sensors



Item Number	MB-M01
Used for	MOE.. sensors
Description	Ball mounting bracket for flexible mounting



Item Number	MB18A
Used for	M18 sensors
Description	Mounting bracket in plast



Item Number	APA18-MB1
Used for	PA18 sensors
Description	Mounting bracket in plast



Item Number	APH18-MB1
Used for	PH18 sensors
Description	Mounting bracket in plast

Photoelectric sensors accessories

Brackets

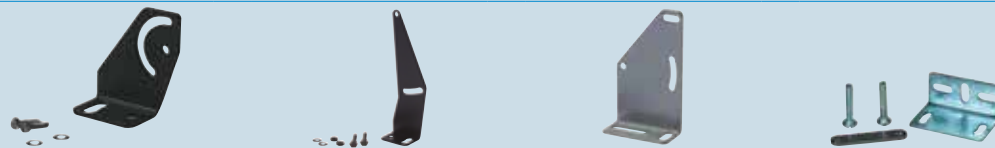

Item Number	APA-2	APB-1	MB02	APD32-MB3
Used for	PA.. sensors	PB	PM	PD32 - LD32
Description	Mounting bracket in steel, black	Mounting bracket in steel, black	Long mounting bracket for wall mounting in steel, chromated	Mounting bracket in steel, chromated

Brackets

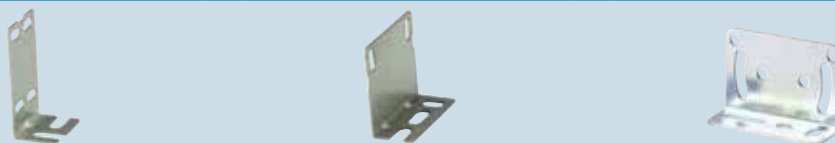

Item Number	APD30 MB1	APD30 MB2	ACP50-1
Used for	PD.. sensors	PD.. sensors	PC50.. sensors
Description	Mounting bracket in steel, chromated	Mounting bracket in steel, chromated	Mounting bracket in steel, chromated

Alignment tools



Item Number	APD140-LA01	APD140-LA02	APD140-TC01
Used for	PD140.. Heavy duty infrared barrier	PD140.. Heavy duty infrared barrier	PD140.. Heavy duty infrared barrier
Description	Laser alignment tool	Laser alignment tool without batteries (Battery: DL1/3N, CR1/3N 3V - Lithium)	Alignment test cable

Conductive level sensors

Types	VN / VNI		VNY / VNYI		VPC		VPP	
Connections	Cable (PVC) 2 m		Screw connection		Screw connection		Screw connection	
								
Electrodes								
Number of electrodes	1, 2, 3 or 4		1, 2, 3 or 4		1, 2 or 3		1, 2 or 3	
Diameter/length (mm)	D5/1000		D5/1000		D4/500		D4/500	
Material	Stainless steel		Stainless steel		Stainless steel		Stainless steel	
Isolation of electrodes	Yes (VNI)		Yes (VNYI)		Yes		Yes	
Isolation	Polyethylene		Polyethylene		Polyethylene		PVDF	
Housing								
Pipe thread	1½"		1½"		½" (VPC x05) or 1" (VPC x10)		½" (VPC x05) or 1" (VPC x10)	
Material	Nylon 6		Nylon 6		PVC		Polypropylene	
References								
1 electrode	VN1	VNI1	VNY1	VNYI1	VPC105	VPC110	VPP105	VPP110
2 electrodes	VN2	VNI2	VNY2	VNYI2	VPC205	VPC210	VPP205	VPP210
3 electrodes	VN3	VNI3	VNY3	VNYI3		VPC310		VPP310
4 electrodes	VN4	VNI4	VNY4	VNYI4				
Specifications								
Degree of protection	IP 67		IP 67		IP 67		IP 67	
Operating temperature	0°C to +90°C		0°C to +90°C		0°C to +60°C		0°C to +100°C	
Approvals/Marks	CE		CE		CE		CE	

Conductive level sensors

Types	VT / VTI	CLH	VH1 / VH2	A 94-10
Connections	Cable (Silicone)	Screw connection	Cable (Neoprene)	Cable (PVC)



Electrodes

Number of electrodes	1, 2, 3 or 4	2 or 4 + reference	1 (hanging)	2 (hanging)
Diameter/length (mm)	D5/1000	D4	D18/36.5 or D32/75.5	D22/75.0
Material	Stainless steel	Stainless steel	Stainless steel	Stainless steel
Isolation of electrodes	Yes (VTI)	Yes	No (VH1) - Yes (VH2)	No
Isolation	Teflon	Kynar, Polyolefine	Nylon 6	

Housing

Pipe thread	1½"	1½"		
Material	Teflon	Polypropylene	Nylon 6	Polyester

References

1 electrode	VT1	VTI1	VH1 or VH2	
2 electrodes	VT2	VTI2		A 94-10
3 electrodes	VT3	VTI3		
4 electrodes	VT4	VTI4		
5 electrodes				CLH5*

Specifications





Degree of protection	IP 67	IP 65	IP 67	IP 67
Operating temperature	0°C to +145°C	-20°C to +90°C	0°C to +90°C	0°C to +60°C
Approvals/Marks	CE	CE	CE	CE

Electrodes (Stainless steel ANSI316)





No Insulation	
1 m	CLE1
2 m	CLE2
Extension 1 m	CLE1X
Kynar (DVDP) Insulation	
1 m	CLE1K
2 m	CLE2K
Extension 1 m	CLE1KX
Polyolefine Insulation	
1 m	CLE1P
2 m	CLE2P
Extension 1 m	CLE1PX

* Electrodes shall be ordered separately



Conductive level sensors

Level controller				
Types	CLD1	CLD2	CLP2 Basic	CLP2
Connections	DIN rail	DIN rail	Plug 11 pin circular	Plug 11 pin circular
				
Function	Filling or emptying. Selectable by rotary switches. Conductive liquids	Filling or emptying. Selectable by rotary switches. Conductive liquids	Filling or emptying. Selectable by rotary switches. Conductive liquids	Filling or emptying. Selectable by rotary switches. Conductive liquids
Adjustable	Yes, Potentiometer	Yes, Potentiometer	Yes, Potentiometer	Yes, Potentiometer
Sensitivity	5 K Ω to 150 K Ω	250 Ω to 500 K Ω	5 K Ω to 150 K Ω	250 Ω to 500 K Ω
Functions switch	- Timer 1 to 30 sec. delay on filling or/and emptying	- Filling / Emptying - 3-levels: Low, Standard and High	- Filling / Emptying	- Filling / Emptying - 3-levels: Low, Standard and High
Input	1 + reference	2 + reference	2 + reference	2 + reference
Output	8 A / 250 VAC SPST	8 A / 250 VAC SPDT	8 A / 250 VAC SPDT	8 A / 250 VAC DPDT
Power Supply	24 V AC/DC	24 - 240 VAC/DC	24 VDC, 24 VAC, 115 VAC or 230 VAC	24 VAC/DC, 115 VAC or 230 VAC
References				
24 240 VAC/DC		CLD2EB1BU24		
24 VDC			CLP2EB1B724	
24 VAC			CLP2EB1B024	
24 VAC/DC	CLD1EA1CM24			CLP2EA1CM24
115 VAC			CLP2EB1B115	CLP2EA1C115
230 VAC			CLP2EB1B230	CLP2EA1C230
Specifications				
Time delay	< 300 mS	< 2S	< 2S	< 300 mS
Housing material	ABS VO	PA66	NORYL PPO	NORYL PPO
Operating temperature	-20°C to +50°C	-20°C to +50°C	-20°C to +50°C	-20°C to +50°C
Output LED colour	Yellow	Yellow	Yellow	Yellow
Power LED colour	Green	Green	Green	Green
Approvals/Marks	CE - UL - CSA	CE - cULus	CE - UL - CSA	CE - UL - CSA

Conductive level sensors

Level controller				
Types	CLD2	CLP2 Master-Slave	CLD4	CLP4
Connections	DIN rail	Plug 11 pin circular	DIN rail	Plug 11 pin circular
				
Function	Filling or emptying. Selectable by rotary switches. Conductive liquids	Filling or emptying. Selectable by rotary switches. Conductive liquids Master - Slave system	Filling, emptying or combinations. Selectable by rotary switches. Conductive liquids	Filling, emptying or combinations. Selectable by rotary switches. Conductive liquids
Adjustable	Yes, Potentiometer	Yes, Potentiometer	Yes, Potentiometer	Yes, Potentiometer
Sensitivity	250 Ω to 500 KΩ	250 Ω to 500 KΩ	250 Ω to 500 KΩ	250 Ω to 500 KΩ
Functions switch	- Filling / Emptying - 3-levels: Low, Standard and High	- Filling / Emptying - 3-levels: Low, Standard and High	- Tank - well - Direct in to out 2 probe - Low and High alarm - 2 system in one, filling and/ or emptying - 3-levels: Low, Standard and High	- Tank - well - Direct in to out 2 probe - Low and High alarm - 2 system in one, filling and/ or emptying - 3-levels: Low, Standard and High
Input	2 + reference	2 + reference	2 to 4 + reference	2 to 4 + reference
Output	8 A / 250 VAC DPDT	8 A / 250 VAC SPDT	8 A / 250 VAC SPDT, SPST	8 A / 250 VAC 2 X SPST
Power Supply	24 VAC/DC, 115 VAC or 230 VAC	24 VAC/DC, 115 VAC or 230 VAC	24 VAC/DC, 115 VAC or 230 VAC	24 VAC/DC, 115 VAC or 230 VAC
References				
24 VAC/DC	CLD2EA1CM24	CLP2FA1BM24	CLD4MA2DM24	CLP4MA2AM24
115 VAC	CLD2EA1C115	CLP2FA1B115	CLD4MA2D115	CLP4MA2A115
230 VAC	CLD2EA1C230	CLP2FA1B230	CLD4MA2D230	CLP4MA2A230
Specifications				
Time delay	< 300 mS	< 300 mS	< 300 mS	< 300 mS
Housing material	ABS VO	NORYL PPO	ABS VO	NORYL PPO
Operating temperature	-20°C to +50°C	-20°C to +50°C	-20°C to +50°C	-20°C to +50°C
Output LED colour	Yellow	Yellow	Yellow	Yellow
Power LED colour	Green	Green	Green	Green
Approvals/Marks	CE - UL - CSA	CE - UL - CSA	CE - UL - CSA	CE - UL - CSA

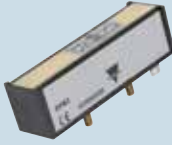
Proximity magnetic sensors, rectangular

Rectangular			
Types	S series	SPB2 series	SPA1 series
			
Dimensions (mm)	11.5 x 79 x 21.2	25.5 x 85 x 24	16 x 90 x 20
Electrical specifications			
Max. switch. voltage contact	250 VAC [SA / SC 2, SB2 / -S5] 1500 VAC [SA / SC 8] 230 VAC [SS2, S.BS.2]	250 VAC	24 VDC [output 1 and 2]
Max. switch. current contact	1 A [SS2, S.BS.2] 3 A [SA2, SC2, SB2, SB2S5, SA8, SC8]	3 A	0.5 A [output 1] 4 A [output 2]
Max. switch. power contact	100 VA [SA / SC 2, SB2 / -S5] 120 VA [SA / SC 8] 60 VA [SS2, S.BS.2]	100 VA	5 VA [output 1] 100 VA [output 2]
Power supply			24 VDC
General specifications			
Operating distance	5 - 32 mm	5 - 30 mm	12 mm
Output connection	PVC cable, 0.5 m (0.24 m Type S5)	Faston [SPB2] 2 m PVC Cable [SPB22MT]	PVC cable, 19 cm Pig-tail
Degree of protection	IP 67	IP 67 [SPB22MT] IP 65 [SPB2]	IP 67
Operating temperature	-25°C to +75°C	-25°C to +75°C	-25°C to +80°C
Housing material	Plastic	Plastic	ABS class V0
References			
Normally open	SA2 SA8		
Normally closed	SC2 SC8		
Change - Over	SS2		
Bistable	SB2 SB2S5	SPB2 SPB22MT	
Bistable CO	S.BS.2		
Normally closed, 2 outputs			SPA1S2 SPA1S3

Proximity magnetic sensors, rectangular

Rectangular

Types	M and MS series	MM series
		

Dimensions (mm)	8.3 x 37 x 16	6.1 x 23.5 x 14 [A6] 7 x 27 x 11 [A3, S1]
-----------------	---------------	--

Electrical specifications

Max. switch. voltage contact	100 VAC [MS1] 230 VAC [MSA1] 500 VAC [MA3, MC3]	100 VAC [S1, A6] 500 VAC [A3]
Max. switch. current contact	0.25 A [MS1] 0.5 A [MA3, MC3] 0.75 A [MSA1]	0.25 A [S1] 0.5 A [A3, A6]
Max. switch. power contact	5 VA [MS1] 10 VA [MSA1, MA3, MC3]	5 VA [S1] 10 VA [A3, A6]

General specifications

Operating distance	7 - 35 mm	10 - 40 mm
Output connection	PVC cable, 0.5 m (2 m, Type MSA1)	PVC cable [A3, S1] Twin lead cable [A6]
Degree of protection	IP 67	IP 67
Operating temperature	-25°C to +75°C	-25°C to +75°C
Housing material	Plastic	Plastic

References

Normally open	MSA1 MA3	MMA3 MMA6
Normally closed	MC3	
Change - Over	MS1	MMS1

Proximity magnetic sensors, cylindrical

Cylindrical

Types	FM... series	FMM... series	FMMP... series
-------	--------------	---------------	----------------



Dimensions (mm)	Ø 9.3 [A3, C3, S1] M10 x 0.75 [A3S5, A6] M12 x 1 [C3S1, A9S1]	M8 x 1	Ø 6 x 25 [L25] Ø 6 x 33 [L33] Ø 6 x 38 [L38]
-----------------	---	--------	--

Electrical specifications

Max. switch. voltage contact	100 VAC [S1, A6] 230 VAC [A9S1] 500 VAC [A3, C3, A3S5, C3S1]	100 VAC [A6, S1] 500 VAC [A3]	140 VAC
Max. switch. current contact	0.25 A [S1] 0.5 A [A3, C3, A6, A3S5, C3S1] 3 A [A9S1]	0.25 A [S1] 0.5 A [A3, A6]	1 A
Max. switch. power contact	5 VA [A3, C3, A3S5, C3S1] 60 VA [A9S1] 100 VA [S1, A6]	5 VA [S1] 10 VA [A3, A6]	10 VA
Max carry current			1.2 A

General specifications

Operating distance	5 - 36 mm	8 - 27 mm	> 8 mm
Output connection	PVC cable 0.5 m for Ø 9.3 2 m for M10 and M12	PVC cable, 2 m	Twin lead cable, 0.5 m
Degree of protection	IP 67	IP 67	IP 67
Operating temperature	-25°C to +75°C	-25°C to +70°C	-20°C to +75°C
Housing material	Plastic [A3, C3, S1] Nickel plated brass [A6] Brass [A3S5, C3S1, A9S1]	Stainless steel [A3, S1] Nickel plated brass [A6]	Plastic

References

Normally open	FMA3 FMA3S5 FMA6 FMA9S1	FMMA3 FMMA6	FMMPA7L25 FMMPA7L33 FMMPA7L38
Normally closed	FMC3 FMC3S1		
Change - Over	FMS1	FMMS1	

Proximity magnetic sensors, cylindrical

Cylindrical

Types	FMP... series	FS... series	FSLP... series	FSM... series
				

Dimensions (mm)	M12 x 1 x 100	Ø 13.5 [A2, A8, C2, C8, S2] M10 x 1.25 [A2S3, S2S1] M12 x 1 [A2S4, S2S4] M16 x 1.5 [B2]	Ø 16	M12 x 1 [A2, A7, S2] M16 x 1 [S2S2AT]
-----------------	---------------	--	------	--

Electrical specifications

Max. switch. voltage contact	120 VAC / DC [C7] 175 VDC, 120 VAC [S1] 200 VDC, 140 VAC [A7] 230 VAC / DC [A9, C9, A9S1] 250 VAC / DC [B2]	230 VAC [S2, S2S1, S2S4] 250 VAC [A2, B2, C2, A2S3, A2S4] 1500 VAC [A8, C8]	100 VAC [A7] 250 VAC [B2]	24 VDC [A7] 230 VAC [S2, S2S2AT] 250 VAC [A2]
Max. switch. current contact	0.25 A [S1] 0.5 A [C7] 1 A [A7] 3 A [B2, A9, C9, A9S1]	1 A [S2, S2S4, S2S1] 3 A [A2, B2, C2, A8, C8, A2S3, A2S4]	0.4 A [A7] 3 A [B2]	0.5 A [S2S2AT] 1 A [S2] 3 A [A2] 50 mA [A7]
Max. switch. power contact	5 VA [S1] 10 VA [A7, C7] 60 VA [A9, C9, A9S1] 120 VA [B2]	60 VA [S2S1, S2S4, S2] 100 VA [A2, B2, C2, A2S3, A2S4] 120 VA [A8, C8]	10 VA [A7] 120 VA [B2]	30 VA [S2S2AT] 60 VA [S2] 100 VA [A2] (A7 negligible)

General specifications

Operating distance	7 - 26 mm	3 - 32 mm	18 - 25 mm (front); >10 - >15 mm (side)	2 - 19 mm
Output connection	PVC cable, 2 m	PVC cable, 2 m 0.5 m for Ø 13.5	PVC cable, 2 m	Silicone cable, 2 m [A7] Silicone cable, 0.5 m [S2S2AT] PVC cable, 2 m [A2, S2]
Degree of protection	IP 67	IP 67	IP 67	IP 67
Operating temperature	-25°C to +75°C	-25°C to +75°C	-30°C to +80°C	-25°C to +75°C [A2, A7, S2] -20°C to +150°C [S2S2AT]
Housing material	Plastic	Plastic [A2, A8, C2, C8, S2, B2] Brass [A2S3 / S4, S2S1 / S4]	Plastic	Brass [S2S2, S2S2AT] Nickel plated brass [A2, A7, S2]

References

Normally open	FMPA7 [black] FMPA9 [black] FMPA9S1 [black]	FSA2 FSA8 FSA2S32MT FSA2S42MT	FSLPA7	FSMA2 FSMA7
Normally closed	FMPC7 [red] FMPC9 [red]	FSC2 FSC8		
Change - Over	FMP51 [blue]	FSS2 FSS2S12MT FSS2S42MT		FSMS2 FSMS2S2AT
Bistable	FMPB2 [grey]	FSB22MT	FSLPB2	

Proximity magnetic sensors, slot

Slot		
Types	ISY series	IM series
		

Dimensions (mm)	10 x 45 x 37	7 x 28 x 18.5
-----------------	--------------	---------------

Electrical specifications

Max. switch. voltage contact	100 VAC [S1] 500 VAC [C3]	100 VAC [S1] 500 VAC [C3]
Max. switch. current contact	0.25 A [S1] 0.5 A [C3]	0.25 A [S1] 0.5 A [C3]
Max. switch. power contact	5 VA [S1] 10 VA [C3]	5 VA [S1] 10 VA [C3]

General specifications



Output connection	PVC cable, 0.5 m	PVC cable, 0.5 m
Degree of protection	IP 67	IP 67
Operating temperature	-25°C to +75°C	-25°C to +75°C
Housing materials	Plastic	Plastic

References

Normally closed	ISYC3	IMC3
Change - Over	ISYS1	IMS1

Types



Magnetic units CL series

Shapes	Rectangular	Trapezoidal	Cylindrical
			

General specifications

Minimum separation:	Dimensions (mm)	References	Dimensions (mm)	References
10	25 x 14 x 8	CL1		
20	44.5 x 12 x 9	CL2		
30	59 x 18 x 9	CL3		
50	76 x 25 x 18	CL4		
Not mandatory		Dimensions (mm)	Dimensions (mm)	References
		90 x 31 x 22.5	Ø 9.3 x 32	CL90
			Ø 13.5 x 65	CL10
			Ø 18 x 6	CL11
			Ø 23 x 9	CL18
			Ø 31 x 10	CL23
			Ø 31 x 10	CL31
			Ø 20 x 10	CL20S1
			Ø 22.1 x 11.3	CL20S3





Level magnetic sensors

Cylindrical			
Types	ILM series	ILMM series	ILMP series
			
Float Diameter (mm)	Ø 53	Ø 28	Ø 25
Output functions			
	Normally open, Normally closed [2, 8] Change-over [S2]	Normally open and normally closed [5, 590, 5ATS1] Normally open [5S1] Normally closed [5S2, 5S2AT]	Normally open, normally closed
Electrical specifications			
Max. switch. voltage contact	230 VAC [S2] - 250 VAC [2] 1500 VAC [8]	240 VAC, 220 VDC	240 VAC, 200 VDC
Max. switch. current contact	1 A [S2] 3 A [2, 8]	0.5 A	0.5 A
Max. switch. power contact	60 VA [S2] - 100 VA [2] 120 VA [8]	50 VA	50 VA
General specifications			
Output connection	Silicone cable, 0.5 m	XLPE cable, 0.3 m 1,1 m [ATS1]	PVC cable, 0.3 m
Min. liquid specific gravity	0.75 kg / dm ³	0.75 kg / dm ³	
Max. pressure	20 kg / cm ²	10 kg / cm ²	2 kg / cm ²
Degree of protection	IP 67	IP 67	IP 67
Operating temperature	-25°C to +120°C [2, 8, S2]	-10°C to +120°C [5, 590] -10°C to +200°C [5ATS1, 5S2AT] -20°C to +120°C [5S1, 5S2]	-20°C to +80°C
Housing materials	AISI 316 Stainless steel	AISI 304 stainless steel [5, 590 5ATS1] AISI316 stainless steel [5S2AT, 5S1, 5S2]	Plastic
References			
Normally open / Normally closed	ILM.2 ILM8	ILMM5 ILMM590 ILMM5ATS1	ILMP5 ILMP5P
Change - Over	ILMS2		
Normally closed		ILMM5S2AT ILMM5S2	
Normally open		ILMM5S1	

Level magnetic sensors

				Cylindrical		
Types	ILMPU - ILU - ILMU series		ILSP series	FLM series - Flux Sensors		
						
Float Diameter (mm)	Ø 17.5 [ILMPU] Ø 31 [ILMU] Ø 45 [ILU]		Ø 44	Ø 20		
Electrical specifications						
Max. switch. voltage contact	240 VAC, 200 VDC [ILMPU5, ILMU5] 250 VAC [ILU2] 1000 VAC [ILU8]		230 VAC [S2] 250 VAC [2] 1500 VAC [8]	100 VAC		
Max. switch. current contact	0.5 A [ILMP, ILM] 1 A [ILUS2] 3 A [ILU2, ILU8]		1 A [S2] 3 A [2, 8]	0.4 A		
Max. switch. power contact	50 VA [ILMP, ILM] 60 VA [ILUS2] 100 VA [ILU2] 120 VA [ILU8]		60 VA [S2] 100 VA [2] 120 VA [8]	10 VA		
General specifications						
Output connection	XLPE cable, 0.3 m [ILMPU5] PVC cable, 0.3 m [ILMU5] Silicone cable, 0.5 m [ILU2, ILU8, ILUS2]		Silicone cable, 0.5 m	HT105 PVC cable ended with 6.35 mm female faston		
Operating distance D_{on}					+5 mm	
Release distance D_{off}					$D_{on} - 2$ mm	
Min. liquid specific gravity	0.70 kg / dm ³ [ILMPU, ILMU] 0.75 kg / dm ³ [ILU]		0.75 kg / dm ³			
Max. pressure	2 kg / cm ² [ILMPU, ILMU] 100 kg / cm ² [ILU]		0.6 kg / cm ²			
Degree of protection	IP 68		IP 67	IP 67		
Operating temperature	-20°C to +80°C [ILMPU, ILMU] -25°C to +100°C [ILU]		-25°C to +100 °C	-30°C to +105°C		
Housing materials	Non toxic polypropylene or plastic		Plastic	Stainless steel		
References						
Normally open / Normally closed	ILMPU5 ILMU5		ILSP2 ILSP8			
Normally open	ILU2 ILU8			FLMA1S1		
Change - Over	ILUS2		ILSPS2			

Ultrasonic sensors, 1 x digital output - Short body

Types	UA18CSD..TI	UA18CSD..M1TI	UA18ESD..TI	UA18ESD..M1TI
Connections	2 m cable	M12 connector	2 m cable	M12 connector
				
Dimensions (mm)	M18 x 53	M18 x 60	M18 x 53	M18 x 60
References				
Sensing distance (Sn)	40 - 300 mm	40 - 300 mm	40 - 300 mm	40 - 300 mm
Operating frequency	≤ 8 Hz	≤ 8 Hz	≤ 8 Hz	≤ 8 Hz
Blind zone	≤ 40 mm	≤ 40 mm	≤ 40 mm	≤ 40 mm
1 x NPN	UA18CSD03NPTI	UA18CSD03NPM1TI	UA18ESD03NPTI	UA18ESD03NPM1TI
1 x PNP	UA18CSD03PPTI	UA18CSD03PPM1TI	UA18ESD03PPTI	UA18ESD03PPM1TI
Sensing distance (Sn)	80 - 800 mm	80 - 800 mm	80 - 800 mm	80 - 800 mm
Operating frequency	≤ 5 Hz	≤ 5 Hz	≤ 5 Hz	≤ 5 Hz
Blind zone	≤ 80 mm	≤ 80 mm	≤ 80 mm	≤ 80 mm
1 x NPN	UA18CSD08NPTI	UA18CSD08NPM1TI	UA18ESD08NPTI	UA18ESD08NPM1TI
1 x PNP	UA18CSD08PPTI	UA18CSD08PPM1TI	UA18ESD08PPTI	UA18ESD08PPM1TI
Specifications				
Rated operating voltage	10 - 30 VDC	10 - 30 VDC	10 - 30 VDC	10 - 30 VDC
Voltage drop	≤ 2.2 VDC	≤ 2.2 VDC	≤ 2.2 VDC	≤ 2.2 VDC
Degree of protection	IP 67	IP 67	IP 67	IP 67
Protection Short-circuit (S) Reverse polarity (P) Transients (T)	SPT	SPT	SPT	SPT
Load current	< 100 mA	< 100 mA	< 100 mA	< 100 mA
Housing material	PBT	PBT	Stainless steel AISI 316L	Stainless steel AISI 316L
Operating temperature	-20°C to +60°C	-20°C to +60°C	-20°C to +60°C	-20°C to +60°C
LED colour	Yellow (output), Green (Echo ON)	Yellow (output), Green (Echo ON)	Yellow (output), Green (Echo ON)	Yellow (output), Green (Echo ON)
Approvals/Marks	CE - cULus	CE - cULus	CE - cULus	CE - cULus

Ultrasonic sensors, analogue output - Short body

Types	UA18CSD..TI	UA18CSD..M1TI	UA18ESD..TI	UA18ESD..M1TI
-------	-------------	---------------	-------------	---------------

Connections	2 m cable	M12 connector	2 m cable	M12 connector
-------------	-----------	---------------	-----------	---------------



Dimensions (mm)	M18 x 53	M18 x 60	M18 x 53	M18 x 60
-----------------	----------	----------	----------	----------

References

Sensing distance (Sn)	40 - 300 mm	40 - 300 mm	40 - 300 mm	40 - 300 mm
Response time	≤ 400 mS	≤ 400 mS	≤ 400 mS	≤ 400 mS
Blind zone	≤ 40 mm	≤ 40 mm	≤ 40 mm	≤ 40 mm
4-20 mA	UA18CSD03AGTI	UA18CSD03AGM1TI	UA18ESD03AGTI	UA18ESD03AGM1TI
0-10 V	UA18CSD03AKTI	UA18CSD03AKM1TI	UA18ESD03AKTI	UA18ESD03AKM1TI
Sensing distance (Sn)	80 - 800 mm	80 - 800 mm	80 - 800 mm	80 - 800 mm
Response time	≤ 400 mS	≤ 400 mS	≤ 400 mS	≤ 400 mS
Blind zone	≤ 80 mm	≤ 80 mm	≤ 80 mm	≤ 80 mm
4-20 mA	UA18CSD08AGTI	UA18CSD08AGM1TI	UA18ESD08AGTI	UA18ESD08AGM1TI
0-10 V	UA18CSD08AKTI	UA18CSD08AKM1TI	UA18ESD08AKTI	UA18ESD08AKM1TI

Specifications

Rated operating voltage NG or PG NK or PK	10 - 30 VDC	10 - 30 VDC	10 - 30 VDC	10 - 30 VDC
Degree of protection	IP 67	IP 67	IP 67	IP 67
Protection Short-circuit (S) Reverse polarity (P) Transients (T)	Supply: PT Analogue output: P	Supply: PT Analogue output: P	Supply: PT Analogue output: P	Supply: PT Analogue output: P
Housing material	PBT	PBT	Stainless Steel AISI 316L	Stainless Steel AISI 316L
Operating temperature	-20°C to +60°C	-20°C to +60°C	-20°C to +60°C	-20°C to +60°C
LED colour	Yellow (output), Green (Echo ON)	Yellow (output), Green (Echo ON)	Yellow (output), Green (Echo ON)	Yellow (output), Green (Echo ON)
Approvals/Marks	CE - cULus	CE - cULus	CE - cULus	CE - cULus

Ultrasonic sensors, 2 x digital outputs

Types	UA18CAD..TI	UA18CAD..MITI	UA30CAD35..TI	UA30CAD35..MITI
Connections	2 m cable	M12 connector	2 m cable	M12 connector



Dimensions (mm)	M18 x 85	M18 x 85	M30 x 90	M30 x 90
-----------------	----------	----------	----------	----------

References

Sensing distance (Sn)	50 - 400 mm	50 - 400 mm	250 - 3500 mm	250 - 3500 mm
Operating frequency	≤ 10 Hz	≤ 10 Hz	≤ 2 Hz	≤ 2 Hz
Blind zone	≤ 50 mm	≤ 50 mm	≤ 250 mm	≤ 250 mm
2 x NPN	UA18CAD04NPTI	UA18CAD04NPM1TI	UA30CAD35NPTI	UA30CAD35NPM1TI
2 x PNP	UA18CAD04PPTI	UA18CAD04PPM1TI	UA30CAD35PPTI	UA30CAD35PPM1TI
Sensing distance (Sn)	100 - 900 mm	100 - 900 mm		
Operating frequency	≤ 4 Hz	≤ 4 Hz		
Blind zone	≤ 100 mm	≤ 100 mm		
2 x NPN	UA18CAD09NPTI	UA18CAD09NPM1TI		
2 x PNP	UA18CAD09PPTI	UA18CAD09PPM1TI		
Sensing distance (Sn)	200 - 2200 mm	200 - 2200 mm		
Operating frequency	≤ 1 Hz	≤ 1 Hz		
Blind zone	≤ 200 mm	≤ 200 mm		
2 x NPN	UA18CAD22NPTI	UA18CAD22NPM1TI		
2 x PNP		UA18CAD22PPM1TI		

Specifications

Rated operating voltage	15 - 30 VDC	15 - 30 VDC	12 - 30 VDC	12 - 30 VDC
Voltage drop	≤ 2.2 VDC	≤ 2.2 VDC	≤ 2.2 VDC	≤ 2.2 VDC
Degree of protection	IP 67	IP 67	IP 67	IP 67
Protection Short-circuit (S)				
Reverse polarity (P)	SPT	SPT	SPT	SPT
Transients (T)				
Load current	< 500 mA	< 500 mA	< 300 mA	< 300 mA
Load current - UL	< 100 mA	< 100 mA	< 100 mA	< 100 mA
Housing material	PBT	PBT	PBT	PBT
Operating temperature	-20°C to +60°C	-20°C to +60°C	-20°C to +70°C	-20°C to +70°C
LED colour	Yellow	Yellow	Yellow, green	Yellow, green
Approvals/Marks	CE - cULus	CE - cULus	CE - cULus	CE - cULus

Ultrasonic sensors, 2 x digital outputs

Types	UA30CAD60..TI	UA30CAD60..M1TI
-------	---------------	-----------------

Connections	2 m cable	M12 connector
-------------	-----------	---------------

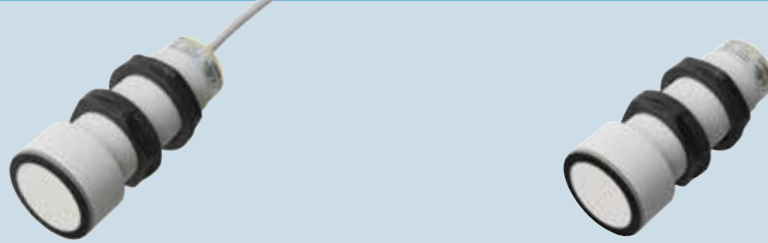

Dimensions (mm)	M30 (Ø40) x 90	M30 (Ø40) x 90
-----------------	----------------	----------------





References

Sensing distance (Sn)	350 - 6000 mm	350 - 6000 mm
Operating frequency	≤ 1 Hz	≤ 1 Hz
Blind zone	≤ 350 mm	≤ 350 mm
2 x NPN	UA30CAD60NPTI	UA30CAD60NPM1TI
2 x PNP	UA30CAD60PPTI	UA30CAD60PPM1TI

Specifications

Rated operating voltage	12 - 30 VDC	12 - 30 VDC
Voltage drop	≤ 2.2 VDC	≤ 2.2 VDC
Degree of protection	IP 67	IP 67
Protection Short-circuit (S) Reverse polarity (P) Transients (T)	SPT	SPT
Load current	< 300 mA	< 300 mA
Load current - UL	< 100 mA	< 100 mA
Housing material	PBT	PBT
Operating temperature	-20°C to +70°C	-20°C to +70°C
LED colour	Yellow, green	Yellow, green
Approvals/Marks	CE - cULus	CE - cULus



Ultrasonic sensors, 2 x digital outputs

Types	UA18EAD..TI	UA18EAD..MITI	UA30EAD35..TI	UA30EAD35..MITI
Connections	2 m cable	M12 connector	2 m cable	M12 connector
				
Dimensions (mm)	M18 x 85	M18 x 85	M30 x 90	M30 x 90
References				
Sensing distance (Sn)	50 - 400 mm	50 - 400 mm	350 - 3500 mm	350 - 3500 mm
Operating frequency	≤ 10 Hz	≤ 10 Hz	≤ 2 Hz	≤ 2 Hz
Blind zone	≤ 50 mm	≤ 50 mm	≤ 350 mm	≤ 350 mm
2 x NPN	UA18EAD04NPTI	UA18EAD04NPM1TI	UA30EAD35NPTI	UA30EAD35NPM1TI
2 x PNP	UA18EAD04PPTI	UA18EAD04PPM1TI	UA30EAD35PPTI	UA30EAD35PPM1TI
Sensing distance (Sn)	100 - 900 mm	100 - 900 mm		
Operating frequency	≤ 4 Hz	≤ 4 Hz		
Blind zone	≤ 100 mm	≤ 100 mm		
2 x NPN	UA18EAD09NPTI	UA18EAD09NPM1TI		
2 x PNP	UA18EAD09PPTI	UA18EAD09PPM1TI		
Sensing distance (Sn)	200 - 1500 mm	200 - 1500 mm		
Operating frequency	≤ 1 Hz	≤ 1 Hz		
Blind zone	≤ 200 mm	≤ 200 mm		
2 x NPN	UA18EAD15NPTI	UA18EAD15NPM1TI		
2 x PNP	UA18EAD15PPTI	UA18EAD15PPM1TI		
Specifications				
Rated operating voltage	15 - 30 VDC	15 - 30 VDC	12 - 30 VDC	12 - 30 VDC
Voltage drop	≤ 2.2 VDC	≤ 2.2 VDC	≤ 2.2 VDC	≤ 2.2 VDC
Degree of protection	IP 67	IP 67	IP 67	IP 67
Protection Short-circuit (S) Reverse polarity (P) Transients (T)	SPT	SPT	SPT	SPT
Load current	< 500 mA	< 500 mA	< 300 mA	< 300 mA
Load current - UL	< 100 mA	< 100 mA	< 100 mA	< 100 mA
Housing material	AISI 316L	AISI 316L	AISI 316L	AISI 316L
Operating temperature	-20°C to +60°C	-20°C to +60°C	-20°C to +70°C	-20°C to +70°C
LED colour	Yellow	Yellow	Yellow, green	Yellow, green
Approvals/Marks	CE - cULus	CE - cULus	CE - cULus	CE - cULus





Ultrasonic sensors, analogue and digital output

Types	UA18CAD..TI	UA18CAD..M1TI	UA30CAD35..TI	UA30CAD35..M1TI
Connections	2 m cable	M12 connector	2 m cable	M12 connector
				
Dimensions (mm)	M18 x 85	M18 x 85	M30 x 90	M30 x 90
References				
Sensing distance (Sn)	50 - 400 mm	50 - 400 mm	250 - 3500 mm	250 - 3500 mm
Operating frequency	≤ 10 Hz	≤ 10 Hz	≤ 2 Hz	≤ 2 Hz
Blind zone	≤ 50 mm	≤ 50 mm	≤ 250 mm	≤ 250 mm
NPN, 4-20 mA	UA18CAD04NGTI	UA18CAD04NGM1TI	UA30CAD35NGTI	UA30CAD35NGM1TI
PNP, 4-20 mA	UA18CAD04PGTI	UA18CAD04PGM1TI	UA30CAD35PGTI	UA30CAD35PGM1TI
NPN, 0-10 V	UA18CAD04NKTI	UA18CAD04NKM1TI	UA30CAD35NKTI	UA30CAD35NKM1TI
PNP, 0-10 V	UA18CAD04PKTI	UA18CAD04PKM1TI	UA30CAD35PKTI	UA30CAD35PKM1TI
Sensing distance (Sn)	100 - 900 mm	100 - 900 mm		
Operating frequency	≤ 4 Hz	≤ 4 Hz		
Blind zone	≤ 100 mm	≤ 100 mm		
NPN, 4-20 mA	UA18CAD09NGTI	UA18CAD09NGM1TI		
PNP, 4-20 mA	UA18CAD09PGTI	UA18CAD09PGM1TI		
NPN, 0-10 V	UA18CAD09NKTI	UA18CAD09NKM1TI		
PNP, 0-10 V	UA18CAD09PKTI	UA18CAD09PKM1TI		
Sensing distance (Sn)	200 - 2200 mm	200 - 2200 mm		
Operating frequency	≤ 1 Hz	≤ 1 Hz		
Blind zone	≤ 200 mm	≤ 200 mm		
NPN, 4-20 mA	UA18CAD22NGTI	UA18CAD22NGM1TI		
PNP, 4-20 mA	UA18CAD22PGTI	UA18CAD22PGM1TI		
NPN, 0-10 V	UA18CAD22NKTI	UA18CAD22NKM1TI		
PNP, 0-10 V	UA18CAD22PKTI	UA18CAD22PKM1TI		
Specifications				
Rated operating voltage				
NG or PG	15 - 30 VDC	15 - 30 VDC	12 - 30 VDC	12 - 30 VDC
NK or PK	15 - 30 VDC	15 - 30 VDC	15 - 30 VDC	15 - 30 VDC
Voltage drop	≤ 2.2 VDC	≤ 2.2 VDC	≤ 2.2 VDC	≤ 2.2 VDC
Degree of protection	IP 67	IP 67	IP 67	IP 67
Protection Short-circuit (S)	Digital output: SPT	Digital output: SPT	Digital output: SPT	Digital output: SPT
Reverse polarity (P)	Supply: PT	Supply: PT	Supply: PT	Supply: PT
Transients (T)	Analogue output: P	Analogue output: P	Analogue output: P	Analogue output: P
Load current	< 500 mA	< 500 mA	< 100 mA	< 100 mA
Load current - UL	< 100 mA	< 100 mA	< 100 mA	< 100 mA
Housing material	PBT	PBT	PBT	PBT
Operating temperature	-20°C to +60°C	-20°C to +60°C	-20°C to +70°C	-20°C to +70°C
LED colour	Yellow	Yellow	Yellow, green	Yellow, green
Approvals/Marks	CE - cULus	CE - cULus	CE - cULus	CE - cULus

Ultrasonic sensors, analogue and digital output

Types	UA30CAD60..TI	UA30CAD60..MITI
Connections	2 m cable	M12 connector
		
Dimensions (mm)	M30 (Ø40) x 90	M30 (Ø40) x 90
References		
Sensing distance (Sn)	350 - 6000 mm	350 - 6000 mm
Operating frequency	≤ 1 Hz	≤ 1 Hz
Blind zone	≤ 350 mm	≤ 350 mm
NPN, 4-20 mA	UA30CAD60NGTI	UA30CAD60NGMITI
PNP, 4-20 mA	UA30CAD60PGTI	UA30CAD60PGMITI
NPN, 0-10 V	UA30CAD60NKTI	UA30CAD60NKMITI
PNP, 0-10 V	UA30CAD60PKTI	UA30CAD60PKMITI
Specifications		
Rated operating voltage NG or PG NK or PK	12 - 30 VDC 15 - 30 VDC	12 - 30 VDC 15 - 30 VDC
Voltage drop	≤ 2.2 VDC	≤ 2.2 VDC
Degree of protection	IP 67	IP 67
Protection Short-circuit (S) Reverse polarity (P) Transients (T)	Digital output: SPT Supply: PT Analogue output: P	Digital output: SPT Supply: PT Analogue output: P
Load current	< 100 mA	< 100 mA
Load current - UL	< 100 mA	< 100 mA
Housing material	PBT	PBT
Operating temperature	-20°C to +70°C	-20°C to +70°C
LED colour	Yellow, green	Yellow, green
Approvals/Marks	CE - cULus	CE - cULus

Ultrasonic sensors, analogue and digital output

Types	UA18EAD..TI	UA18EAD..MITI	UA30EAD35..TI	UA30EAD35..MITI
Connections	2 m cable	M12 connector	2 m cable	M12 connector
				
Dimensions (mm)	M18 x 85	M18 x 85	M30 x 93	M30 x 100
References				
Sensing distance (Sn)	50 - 400 mm	50 - 400 mm	350 - 3500 mm	350 - 3500 mm
Operating frequency	≤ 10 Hz	≤ 10 Hz	≤ 2 Hz	≤ 2 Hz
Blind zone	≤ 50 mm	≤ 50 mm	≤ 350 mm	≤ 350 mm
NPN, 4-20 mA	UA18EAD04NGTI	UA18EAD04NGM1TI	UA30EAD35NGTI	UA30EAD35NGM1TI
PNP, 4-20 mA	UA18EAD04PGTI	UA18EAD04PGM1TI	UA30EAD35PGTI	UA30EAD35PGM1TI
NPN, 0-10 V	UA18EAD04NKTI	UA18EAD04NKM1TI	UA30EAD35NKTI	UA30EAD35NKM1TI
PNP, 0-10 V	UA18EAD04PKTI	UA18EAD04PKM1TI	UA30EAD35PKTI	UA30EAD35PKM1TI
Sensing distance (Sn)	100 - 900 mm	100 - 900 mm		
Operating frequency	≤ 4 Hz	≤ 4 Hz		
Blind zone	≤ 100 mm	≤ 100 mm		
NPN, 4-20 mA	UA18EAD09NGTI	UA18EAD09NGM1TI		
PNP, 4-20 mA	UA18EAD09PGTI	UA18EAD09PGM1TI		
NPN, 0-10 V	UA18EAD09NKTI	UA18EAD09NKM1TI		
PNP, 0-10 V	UA18EAD09PKTI	UA18EAD09PKM1TI		
Sensing distance (Sn)	200 - 1500 mm	200 - 1500 mm		
Operating frequency	≤ 1 Hz	≤ 1 Hz		
Blind zone	≤ 200 mm	≤ 200 mm		
NPN, 4-20 mA	UA18EAD15NGTI	UA18EAD15NGM1TI		
PNP, 4-20 mA	UA18EAD15PGTI	UA18EAD15PGM1TI		
NPN, 0-10 V	UA18EAD15NKTI	UA18EAD15NKM1TI		
PNP, 0-10 V	UA18EAD15PKTI	UA18EAD15PKM1TI		
Specifications				
Rated operating voltage NG or PG NK or PK	15 - 30 VDC 15 - 30 VDC	15 - 30 VDC 15 - 30 VDC	12 - 30 VDC 15 - 30 VDC	12 - 30 VDC 15 - 30 VDC
Voltage drop	≤ 2.2 VDC	≤ 2.2 VDC	≤ 2.2 VDC	≤ 2.2 VDC
Degree of protection	IP 67	IP 67	IP 67	IP 67
Protection Short-circuit (S) Reverse polarity (P) Transients (T)	Digital output: SPT Supply: PT Analogue output: P	Digital output: SPT Supply: PT Analogue output: P	Digital output: SPT Supply: PT Analogue output: P	Digital output: SPT Supply: PT Analogue output: P
Load current	< 100 mA	< 100 mA	< 100 mA	< 100 mA
Load current - UL	< 100 mA	< 100 mA	< 100 mA	< 100 mA
Housing material	AISI 316L	AISI 316L	AISI 316L	AISI 316L
Operating temperature	-20°C to +60°C	-20°C to +60°C	-20°C to +70°C	-20°C to +70°C
LED colour	Yellow	Yellow	Yellow, green	Yellow, green
Approvals/Marks	CE - cULus	CE - cULus	CE - cULus	CE - cULus

Ultrasonic sensors, DC, analogue, remote teach

	Programmable RS232	Integrated amplifier
Types	UA30CLD..M7	UA12BLD..M1TR
Connections	M16 connector	M12 connector



Dimensions (mm)	M30 x 136	M12 x 79
------------------------	------------------	-----------------

References diffuse reflective

Operating frequency	5 - 30 Hz Programmable	20 Hz
Sensing distance (Sn)	150 - 1500 mm adj.	25 - 200 mm adj.
0-10 VDC	UA30CLD15FKM7	
4-20 mA	UA30CLD15FGM7	
NPN-NO/NC		UA12BLD02NPM1TR
PNP-NO/NC		UA12BLD02PPM1TR
Sensing distance (Sn)	250 - 2000 mm adj.	
0-10 VDC	UA30CLD20FKM7	
4-20 mA	UA30CLD20FGM7	
Sensing distance (Sn)	350 - 3500 mm adj.	
0-10 VDC	UA30CLD35FKM7	
4-20 mA	UA30CLD35FGM7	

Specifications

Rated operating voltage	19 - 30 VDC	10 - 30 VDC
Voltage drop	≤ 2.5 VDC	≤ 4.5 V
Degree of protection	IP 67	IP 65
Protection Short-circuit (S) Reverse polarity (P) Transients (T)	SPT	SPT
Load current	< 100 mA Analogue see type	< 100 mA
Housing material	PBTB	Stainless Steel
Operating temperature	-15°C to +70°C	-20°C to +70°C
LED colour	Yellow + Green	
Remarks	Hold/sync. input RS232	
Approvals/Marks	CE - UL - cUL	CE

Adapters

	AUA - RT	UCC	UCP1 and UCP2
Types	AUA - RT	UCC	UCP1 and UCP2
Connections	M12 connector	Terminal block	Terminal block



Dimensions (mm)	17 x 56	38.5 x 80.5	38.5 x 80.5
------------------------	----------------	--------------------	--------------------



Specifications

Programming adapter for remote teach sensors ending with "RT"

RS232 to RS485 adapter



Programming adapter RS232

Motion sensors

	Standard range RAD series		Long range IRS series
Types	RAD 01	RAD 02	IRS 01
Connections	cable	cable	cable
			
Dimensions (mm)	118 x 80 x 53	118 x 80 x 53	137 x 188 x 91.5
Features	K-Band radar sensor compatible with all swinging and sliding automatic doors. 3-D adjustable position of the sensor offers precise orientation of the activation pattern. Microprocessor technology filters out possible weather condition interferences. IR remote controller can be added for easy adjustment.		K-Band unidirectional long range motion sensor for trouble-free opening of all types of industrial automatic doors. To detect either people or vehicles, whether they are moving towards or away from the sensor. Microprocessor technology filters out possible weather condition interferences. IR remote controller can be added for easy adjustment.
Input specifications			
Detection Angle	V: 0 to 90° in 15° increments L: ±30° in 7.5° increments	V: 0 to 90° in 15° increments L: ±30° in 7.5° increments	V: ±45° in 15° increments L: ±45° in 15° increments
Detecting Area	Mounting height 2.2 m	Mounting height 2.2 m	Mounting height 2.5 m~7 m
Wide sensing field	4 m (W) x 2 m (D)	4 m (W) x 2 m (D)	2.5 m (W) x 8 m (D)
Narrow sensing field	2 m (W) x 2.5 m (D)	2 m (W) x 2.5 m (D)	2.5 m (W) x 10 m (D)
Detection Mode	Bidirectional	Uni & Bidirectional	Uni & Bidirectional
Motion Detecting Speed	0.05~1 m/s	0.05~1 m/s	0.05~3.0 m/s along sensor axis
Adjustments			
Sensitivity	10 levels (1 to 10)	10 levels (1 to 10)	5 levels (1 to 5)
Hold Time	From 0.5 to 9 s in 10 steps	From 0.5 to 9 s in 10 steps	From 0.5 to 9 s in 10 steps
Immunity Detection	"Quasi-presence", normal, increased immunity	"Quasi-presence", normal, increased immunity	"Quasi-presence", normal, increased immunity, LTS
Direction Recognition	- Bidirectional detection	- Unidirectional approaching - Unidirectional departing - Uni & Bidirectional detection	- Unidirectional approaching - Unidirectional departing - Uni & Bidirectional detection
Operating Modes (or relays assignment)			- Differentiation between people and vehicles - People suppression - Vehicles suppression - People or vehicles with direction segregation
LTS			Lateral traffics suppression "toggle" type function
Output specifications			
Output Relay SPDT			
Max. contact voltage	24 VDC / 120 VAC	24 VDC / 120 VAC	24 VDC / 120 VAC
Max. contact current	1 A (resistive)	1 A (resistive)	1 A (resistive)
Max. switching power	30 W (DC) / 120 VA (AC)	30 W (DC) / 120 VA (AC)	30 W (DC) / 120 VA (AC)
Hold time	0.5~9 s (adjustable)	0.5~9 s (adjustable)	0.5~6 s (adjustable)
Electrical specifications			
Frequency emitted	24.125 GHz	24.125 GHz	24.125 GHz
Rated supply voltage	12~24 VAC ±10% 12~24 VDC +30% / -10%	12~24 VAC ±10% 12~24 VDC +30% / -10%	12~24 VAC ±10% 12~24 VDC +30% / -10%
Mains frequency	50 to 60 Hz	50 to 60 Hz	50 to 60 Hz
Power consumption	< 0.5 W	< 0.5 W	< 1.2 W
Approvals	CE - FCC - cURus	CE - FCC - cURus	CE - FCC - cURus
References			
Sensor	RAD 01	RAD 02	IRS 01
Remote controller	RAD 00 RC	RAD 00 RC	IRS 00 RC



Motion and presence sensors

Combined motion and presence detectors for pedestrian doors

Types	GUARDIAN 1	GUARDIAN 2
Connections	Terminal block	Terminal block
		
Dimensions (mm)	210 x 77 x 58	210 x 77 x 58
Technology	Digital video camera technology 640 x 480	Digital video camera technology 640 x 480
Door types	Streight sliding doors	Curved and Streight sliding doors
Features	The Guardian sensor is a unique motion and presence detector that provides maximum safety and protection in pedestrian sliding door installations. Equipped with the latest digital video camera technology, Guardian watches over the entrance and exit area safeguarding people within, while at the same time controlling the doors. Guardian is able to ignore cross traffic, and it has a brilliant capability of self-adjusting to changes in the environment and weather conditions	
Input specifications		
Mounting height	180 cm to 300 cm	180 cm to 300 cm
Motion zone sensing area	Hight 180 cm = 246 x 204 cm Hight 220 cm = 300 x 249 cm Hight 300 cm = 410 x 340 cm	Hight 180 cm = 246 x 204 cm Hight 220 cm = 300 x 249 cm Hight 300 cm = 410 x 340 cm
Presence zone sensing area	Hight 180 cm = 42 cm x door width Hight 220 cm = 51 cm x door width Hight 300 cm = 70 cm x door width	Hight 180 cm = 42 cm x door width Hight 220 cm = 51 cm x door width Hight 300 cm = 70 cm x door width
Maximum door radius vs. Mounting height		Hight 180 cm = Radius 130 cm Hight 220 cm = Radius 170 cm Hight 300 cm = Radius 200 cm
Sensitivity	Adjusting in 7 steps	Adjusting in 7 steps
Presence time	7 step rotary switch: (10, 30 sec.) 1 min, 5 min (Not accordance to DIN18650)	7 step rotary switch: (10, 30 sec.) 1 min, 5 min (Not accordance to DIN18650)
Ambient Light	10 lux - 50.000 lux	10 lux - 50.000 lux
Output specifications		
Output function	Safety and Motion Zone: Relay - SPST Common relay data: 1 A DC 30 VDC 600.000 cycles @ 0.5 A, 50 VAC/30 VDC	Safety and Motion Zone: Relay - SPST Common relay data: 1 A DC 30 VDC 600.000 cycles @ 0.5 A, 50 VAC/30 VDC
General specifications		
Rated operating voltage	12 - 24 VAC	12 - 24 VAC
No load supply current	Max. 230 mA	Max. 230 mA
Test input. Active high	ON > 9 VAC/VDC OFF < 6 VAC/VDC	ON > 9 VAC/VDC OFF < 6 VAC/VDC
Test input. Active low	ON < 6 VAC/VDC OFF > 9 VAC/VDC	ON < 6 VAC/VDC OFF > 9 VAC/VDC
Type of ESPE	Type 2	Type 2
Degree of protection	IP 64	IP 64
TÜV	In acc. with machinery directive 2006/42/EC, annex I DIN 18650-1 § 5.7.4, edition 2005 (prEN16005), EN13241-1, EN 12978	In acc. with machinery directive 2006/42/EC, annex I DIN 18650-1 § 5.7.4, edition 2005 (prEN16005), EN13241-1, EN 12978
UL-approved	cURus: UL325, CSA-C22.2 No. 247	cURus: UL325, CSA-C22.2 No. 247
Marking	CE	CE
References		
Marking	GUARDIAN 1	GUARDIAN 2



Environmental sensors

Environmental sensors - CGES series



Types	CGESHTD..N CGESHTPD...N	CGESHTW CGESHTPW	CGESAIRVEL
			
Dimensions (mm)	80 x 80 x 37.2 (probe 200 mm)	85 x 100 x 26	80 x 80 x 37.2 (cable length 1m)
Function	Humidity and Temperature	Humidity and Temperature	Air Velocity measurement
Mounting	Duct mounting	Wall mounting	Duct mounting
Input specifications			
Relative humidity			
Working range	10 to 95%	0 to 95%	
Accuracy @ 20°C	±2.5% RH	±2% (40 to 60%RH) ±3% (10 to 90%RH)	
Temperature			
Sensor	Pt1000 DIN A	Pt1000 DIN A / Pt100 DIN A	
Accuracy @ 20°C	±0.3°C	Vout: ±0.25°C / Aout: ±0.4°C	
Air Velocity			
Working range			0 to 10 m/s (0 to 2000 ft/min) 0 to 15 m/s (0 to 3000 ft/min) 0 to 20 m/s (0 to 4000 ft/min)
Accuracy @ 20°C			±0.2 m/s +3% of m.v.
Electrical specifications			
Output	0-10 V or 4-20 mA (2 wires)	0-10 V or 4-20 mA (2 wires)	0-10 V or 4-20 mA
Supply Voltage	24 VAC ±20% / 15-35 VDC	24 VAC ±20% / 15-35 VDC	24 VAC/DC ±20%
Consumption			
DC supply	typical 5 mA	typical 4 mA	max. 150 mA
AC supply	typical 13 mAeff	typical 15 mAeff	max. 90 mA
General specifications			
Cable gland	M16 x 1.5 cable Ø4.5 - 10 mm		M16 x 1.5 cable Ø4.5 - 10 mm
Electrical connections	Screw terminals max. 1.5 mm ² (AWG 16)	Screw terminals max. 1.5 mm ² (AWG 16)	Screw terminals max. 1.5 mm ² (AWG 16)
Working temperature range	-15°C to 60°C	-5°C to 55°C	-10°C to 50°C
Storage temperature range	-25°C to 60°C	-25°C to 60°C	-30°C to 60°C
Degree of protection	IP 65; Nema 4	IP 20	IP 65; Nema 4
Conformity	EN 61000-6-1, EN 61000-6-3, EN 61326-1+A1+A2	EN 50081-1 FCC Part15 ClassB EN 50082-1 ICES-003 ClassB	EN 50081-1, EN 50082-1, EN 50082-2
Approvals/Marks	CE - RoHS	CE - RoHS	CE - RoHS
References			
For ordering key details, please refer to www.productselection.net			

Environmental sensors

Environmental sensors - CGES series

Types	CGESCO2W - CGESCO2TW - CGESCO2THW	CGESCO2D...N
		
Dimensions (mm)	85 x 100 x 26	80.6 x 101 x 46 (probe 200 mm)
Function	CO ₂ , Relative Humidity and Temperature	CO ₂
Mounting	Wall mounting	Duct mounting
Input specifications		
Relative humidity		
Working range	10 to 90%	
Accuracy @ 20°C	±3% (30 to 70% RH) ±5% (10 to 90% RH)	
Temperature		
Sensor	Pt1000 DIN A	
Accuracy @ 20°C	Vout: ±0.3%°C / Aout: ±0.7°C	
CO ₂		
Working range	0 to 2000 ppm / 0 to 5000 ppm	0 to 2000 ppm / 0 to 5000 ppm
Accuracy @ 20°C		
2000 ppm	< ± 50 ppm +2% of m.v.	< ± 50 ppm +2% of m.v.
5000 ppm	< ± 50 ppm +3% of m.v.	< ± 50 ppm +3% of m.v.
Electrical specifications		
Output	0-10 V or 4-20 mA or switching	0-10 V or 4-20 mA
Supply Voltage	24 VAC ±20% / 15-35 VDC	24 VAC ±20% / 15-35 VDC
Consumption		
DC supply	<3 W	
AC supply	<3 W	
General specifications		
Cable gland	M16 x 1.5 cable	
Electrical connections	Screw terminals max. 1.5 mm ² (AWG 16)	Screw terminals max. 2.5 mm ² (AWG 14)
Working temperature range	-5°C to 55°C	0°C to 50°C
Storage temperature range	-20°C to 60°C	-20°C to 60°C
Degree of protection	IP 20	IP 65; Nema 4
Conformity	EN 61000-6-3, EN61326-1+A1+A2:05.2002 EN 61000-6-1	EN 61000-6-3 ÖVE EN61326-1+A1+A2:05.2002 EN 61000-6-1, FCC Part 15 ICES-003 ClassB
Approvals/Marks	CE - RoHS	CE - RoHS
References		
For ordering key details, please refer to www.productselection.net		

Environmental sensors

	Wind vane	Cup anemometer
Types	DWS-D-D...	DWS-V-D...
Connections	2 m cable	2 m cable
		
Dimensions (mm)	207 x 174	183 x 145
Function	Wind direction	Wind speed
References wind vane		
Wind indication	0° and 90° intervals	
	DWS-D-DAC13	
Wind indication	±7° and left/right	
	DWS-D-DDC13	
References cup anemometer		
Operating temperature		-20°C to 60°C
Heating		Yes
Air Velocity		from 1.5 m/s to 30 m/s
		DWS-V-DAC13
Operating temperature		0°C to 60°C
Heating		No
Air Velocity		from 1.5 m/s to 30 m/s
		DWS-V-DBC05
General specifications		
Rated operating voltage	12 - 24 VDC	12 - 24 VDC
Voltage drop	Typ. 4.9 VDC	Typ. 4.9 VDC
Degree of protection	IP 54	IP 54
Output frequency		10 Hz pr. m/s
Signal	NPN/PNP square wave 12.5 mA ± 2 mA	
Housing material	Body: Black PVC Rotor: Stainless steel	Body: Black PVC Rotor: Stainless steel
Approvals/Marks	CE	CE

Environmental sensors

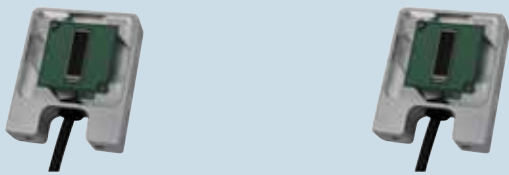
	Solar irradiance sensor		Pyranometer
Types	PVS-1V	PVS-1A	PVS-2A
Connections			
Dimensions (mm)	57 x 48 x 15 (not including clamp)	62 x 48 x 15 (not including clamp)	162 x 215 x 40
Description	Solar irradiance sensor based on photovoltaic technology built with a solid aluminium case and anti-UV encapsulating resin	Solar irradiance sensor based on photovoltaic technology built with a solid aluminium case and anti-UV encapsulating resin	Global solar radiation sensor based on a thermopile transducer compliant with WMO (World Meteorological Organization) standards for environmental monitoring, provided with worldwide valid calibration certificate

Environmental specification

Operating temperature	-10°C to 80°C	-10°C to 80°C	-40°C to 80°C
Degree of protection	IP 67	IP 67	IP 67

General specification













Technology	Crystalline calibrated cell	Crystalline calibrated cell	2nd Class Thermopile Pyranometer according to ISO9060
Output	80 mV @ 1000 W/m ² STC	4-20 mA	4-20 mA
Calibration	According to IEC 60904-2 and 60904-4 (calibration certificate as option)	According to IEC 60904-2 and 60904-4 (calibration certificate as option)	According to ISO9847 (calibration certificate included)
Solar irradiance range	0-1250 W/m 20-1250 W/m ²	0-1250 W/m 20-1250 W/m ²	0-2000 W/m 20-2000 W/m ²
Connector	3 PIN Phoenix M8 IP67 connector (male and female included)	3 PIN Phoenix M8 IP67 connector (male and female included)	7 pin IP68 connector (male, female and 10 meters cable included)
Housing material	Aluminium	Aluminium	Aluminium
Power Supply	Self-powered	Powered by VMU-P module through the 4-20 mA current loop	10-28 VDC, power consumption < 0.1 W
Approvals/Marks	CE	CE	CE

References

For ordering key details, please refer to www.productselection.net

Intrinsic safety

Explosion proof sensors

Types	Cylindrical series FSQ	Rectangular series MQ	Level series ILM
			
Exter. Dimensions (mm) Float Dimensions (mm)	Ø16 x 110	37 x 16 x 8.3	Spherical Ø 53 [S], Cylindrical Ø 45x55 [C]
Category	2G, 2D	2G, 2D [MQx1EX] 1G, 1D [MQA0EX]	2G, 2D [ILMx2] 1G, 1D [ILMx0]
EX Identification	 II2GExmbIICT5Gb  II2DExmbIICT100°CDbIP67	 II2GExmbIICT5Gb [MQx1EX]  II2DExmbIICT100°CDbIP67 [MQx1EX]  II1GExialIICT6Ga [MQA0EX]  II1DExialIICT100°CdIP67 [MQA0EX]	 II2GExmbIICT5Gb [ILMx2]  II2DExmbIICT100°CDbIP67 [ILMx2]  II1GExialIICT6Ga [ILMx0]  II1DExialIICT100°CdIP67 [ILMx0]

General specifications

Max. switch. voltage contact	250 VAC	230 VAC/DC [MQA1EX, MQC1EX] 30 VAC/DC [MQA0EX] 150 VAC/DC [MQS1EX]	250 VAC/DC [ILMA2] 230 VAC/DC [ILMS2] 30 VAC/DC [ILMx0]
Max. switch. current contact	3 A	0.25 to 0.75 A [MQx1EX] 120 mA [MQA0EX]	3 A [ILMA2]; 1A [ILMS2] 120 mA [ILMx0]
Max. switch. power contact	100 VA	5 to 10 VA [MQx1EX] - [MQA0EX]	100 VA [ILMA2] 60 VA [ILMS2]
Operating distance	8 - 30 mm	10 - 35 mm	-
Degree of protection	IP 67 IP66 (FSQA2HFEX)	IP 67	IP 67
Temperature Class	T5	T5 [MQx1EX] T6 [MQA0EX]	T5 [ILMx2] T6 [ILMx0]
Body material	Stainless steel AISI 303	Self-exting. PP + 30% glass fiber	Stainless steel AISI 316
Approvals/Mark	CE - TÜV Sud	CE - TÜV Sud	CE - TÜV Sud

References

Normally open	FSQA2B01SLEX FSQA2HFEX	MQA1EX MQA0EX	ILMA2SSLEX ILMA2CSLEX ILMA0SSLEX ILMA0CSLEX
Normally closed		MQC1EX	
Change - Over		MQS1EX	ILMS2SEX ILMS2CEX ILMS0SEX ILMS0CEX

Safety light curtains

Safety light curtains, safety category 2
hand resolution

Safety light curtains, safety category 2
presence resolution

Types

SC2...

SC2...



General specifications

Power supply	24 VDC \pm 20%	24 VDC \pm 20%
OSSD outputs	2 PNP	2 PNP
Output connections	M12 4-pole connector for TX M12 5-pole connector for RX	M12 4-pole connector for TX M12 5-pole connector for RX
Safety category	Category 2	Category 2
Auxiliary functions	Reset / Test; Automatic Restart	Reset / Test; Automatic Restart
Housing material	Painted aluminium (yellow RAL 1003)	Painted aluminium (yellow RAL 1003)
Ambient light rejection	IEC 61496-2	IEC 61496-2
Degree of protection	IP 65 (EN 60529)	IP 65 (EN 60529)
Operating temperature	-10°C to +55°C	-10°C to +55°C
Approvals/Marks	CE - TÜV - cULus listed	CE - TÜV - cULus listed

References

Resolution	Range	Protected height (mm)	No. of beams	Response time (ms)	REFERENCES	Protected height (mm)	No. of beams	Response time (ms)	REFERENCES
Hand 30 mm	0.2-19 m	150	8	8	SC2AR30150D19				
		300	16	9	SC2AR30300D19				
		450	24	11	SC2AR30450D19				
		600	32	12	SC2AR30600D19				
		750	40	14	SC2AR30750D19				
		900	48	15	SC2AR30900D19				
		1050	56	17	SC2AR301050D19				
		1200	64	18	SC2AR301200D19				
		1350	72	20	SC2AR301350D19				
Presence 90 mm	0.2-19 m	1500	80	21	SC2AR301500D19	300	5	9	SC2AR90300D19
						450	7	10	SC2AR90450D19
						600	9	11	SC2AR90600D19
						750	11	12	SC2AR90750D19
						900	13	13	SC2AR90900D19
						1050	15	14	SC2AR901050D19
						1200	17	15	SC2AR901200D19
						1350	19	16	SC2AR901350D19
						1500	21	17	SC2AR901500D19

Safety light curtains

Safety light curtains, safety category 4
finger resolution

Safety light curtains, safety category 4
hand resolution

Types

SC4...

SC4...



General specifications

Power supply	24 VDC ±20%	24 VDC ±20%
OSSD outputs	2 PNP	2 PNP
Output connections	M12 4-pole connector for TX M12 8-pole connector for RX	M12 4-pole connector for TX M12 8-pole connector for RX
Safety category	Category 4	Category 4
Auxiliary functions	Reset / Test; Selectable Manual/Auto. Restart; Selectable EDM	Reset / Test; Selectable Manual/Auto. Restart; Selectable EDM
Housing material	Painted aluminium (yellow RAL 1003)	Painted aluminium (yellow RAL 1003)
Ambient light rejection	IEC 61496-2	IEC 61496-2
Degree of protection	IP 65 (EN 60529)	IP 65 (EN 60529)
Operating temperature	0°C to +55°C	0°C to +55°C
Approvals/Marks	CE - TÜV - cULus listed	CE - TÜV - cULus listed

References

Resolution	Range	Protected height (mm)	No. of beams	Response time (ms)	REFERENCES	Protected height (mm)	No. of beams	Response time (ms)	REFERENCES
Finger 14 mm	0.2 - 6 m	150	16	11	SC4ED14150D6				
		300	32	15	SC4ED14300D6				
		450	48	18	SC4ED14450D6				
		600	64	22	SC4ED14600D6				
		750	80	25	SC4ED14750D6				
		900	96	29	SC4ED14900D6				
		1050	112	33	SC4ED141050D6				
		1200	128	36	SC4ED141200D6				
Hand 30 mm	0.2 - 19 m					150	8	9	SC4ED30150D19
						300	16	11	SC4ED30300D19
						450	24	13	SC4ED30450D19
						600	32	14	SC4ED30600D19
						750	40	16	SC4ED30750D19
						900	48	18	SC4ED30900D19
						1050	56	19	SC4ED301050D19
						1200	64	21	SC4ED301200D19
						1350	72	23	SC4ED301350D19
						1500	80	25	SC4ED301500D19
				1650	88	26	SC4ED301650D19		

Safety magnetic sensors

Safety magnetic sensors

Types

SMS...

CLS...



Electrical specifications

Max. switch. voltage	100 VAC
Max. switch. power	5 VA
Max. switch. current	0.25 A

General specifications

External dimensions (mm)	88 x 25 x 13; M18x1 SMSA2; M30x1.5 SMSA3P	
Suitable magnetic unit	CLS; CLSA2 (SMSA2P); CLSA2M (SMSA2M); CLSA3 (SMSA3P)	
Output connection	Cable (PVC, AWG 22 to 26, L=2 m.); pig tail with M12 connector, L=0.3 m	
Degree of protection	IP 67	
Operating temperature	-25°C to +70°C	
Housing material	Plastic; PBT + 30 % glass (SMSA2P and SMSA3P); Stainless steel (SMSA2M)	Plastic (CLS, CLSA2, CLS3); Stainless steel (CLSA2M)
Approvals/Marks	CE - (UL version is available for some items with different codification)	

References

	Safety Aux. Outputs	Aux. Outputs	REFERENCES	Dimensions	REFERENCES
Housing type: Rectangular Material: Plastic	1NO		SMS10	88 x 25 x 13	CLS
	1NO	1NC	SMS10NC		
	1NO	1NC	SMS10NCCM1 0.3 m cable with M12 conn.		
	1NO+1NC		SMS01		
	1NO+1NC		SMS02		
	1NO+1NC		SMS02LD LED on NC contact		
	1NO+1NC		SMS02S1 Resistor on NO contact		
	2NO		SMS03		
	2NO		SMS03+ CM1A4/03MT 0.3 m cable with M12 conn.		
	2NO	1NC	SMS03NC		
Housing type: Cylindrical Material: Plastic	1NO+1NC		SMSA2P02	Ø25.1 x 9.3	CLSA2
	1NO+1NC		SMSA2P02LD LED on NC contact		
	2NO		SMSA2P03		
	1NO		SMSA2P10	Ø30 x 16	CLSA3
	2NO		SMSA2P30		
	1NO+1NC		SMSA3P02		
	2NO		SMSA3P03		
2NO		SMSA3P30			
Housing type: Cylindrical Material: Stainless steel	1NO+1NC		SMSA2M02	Ø25.1 x 9.3	CLSA2M
	1NO		SMSA2M10		

Connectors and brackets

General Accessories, sensors

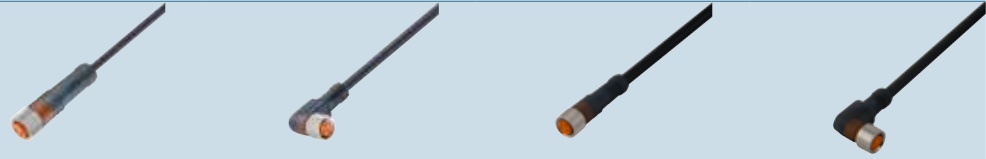

Dimensions (mm)	Straight M8 connector PVC cable	Angled M8 connector PVC cable	Straight M8 connector PVC cable	Angled M8 connector PVC cable
Used for	3-wire DC Sensors	3-wire DC Sensors	4-wire DC Sensors	4-wire DC Sensors
2 m cable	CONB53NF-S2	CONB53NF-A2	CONB54NF-S2	CONB54NF-A2
5 m cable	CONB53NF-S5	CONB53NF-A5	CONB54NF-S5	CONB54NF-A5
10 m cable	CONB53NF-S10	CONB53NF-A10	CONB54NF-S10	CONB54NF-A10
15 m cable	CONB53NF-S15	CONB53NF-A15	CONB54NF-S15	CONB54NF-A15
Degree of protection	IP 67	IP 67	IP 67	IP 67
PUR version	Add "P" at the end of the part number	Add "P" at the end of the part number	Add "P" at the end of the part number	Add "P" at the end of the part number



Dimensions (mm)	Straight M12 connector TPE cable	Angled M12 connector TPE cable	Straight M12 connector PVC cable	Angled M12 connector PVC cable
Used for	4-wire DC	4-wire DC	3-, 4- or 5-wire DC	3-, 4- or 5-wire DC
2 m cable, 3-pin			CONB13NF-S2	CONB13NF-A2
5 m cable, 3-pin			CONB13NF-S5	CONB13NF-A5
10 m cable, 3-pin			CONB13NF-S10	CONB13NF-A10
15 m cable, 3-pin			CONB13NF-S15	CONB13NF-A15
2 m cable, 4-pin	CONB14NF-S2W	CONB14NF-A2W	CONB14NF-S2	CONB14NF-A2
5 m cable, 4-pin	CONB14NF-S5W	CONB14NF-A5W	CONB14NF-S5	CONB14NF-A5
10 m cable, 4-pin			CONB14NF-S10	CONB14NF-A10
15 m cable, 4-pin			CONB14NF-S15	CONB14NF-A15
2 m cable, 5-pin			CONB15NF-S2	CONB15NF-A2
5 m cable, 5-pin			CONB15NF-S5	CONB15NF-A5
10 m cable, 5-pin			CONB15NF-S10	CONB15NF-A10
15 m cable, 5-pin			CONB15NF-S15	CONB15NF-A15
Degree of protection	IP69K	IP69K	IP 67	IP 67
PUR version			Add "P" at the end of the part number	Add "P" at the end of the part number

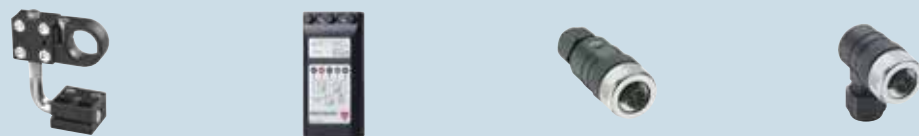

Dimensions (mm)	-	65 x 27 x 130	Straight M12 connector	Angled M12 connector
Used for	Cylindrical 4 - 30 mm sensor	Testing sensor	4-wire DC	4-wire DC
Item number	AMB4-30	ST-03		
No cable 4-pin			CONB14NF-S	CONB14NF-A
Description	Universal sensor mounting bracket	Sensor tester for: NAMUR and 2-, 3- or 4-wire DC NPN/PNP and NO/NC with LED and Buzzer	Terminal connection	Terminal connection
Degree of protection			IP 67	IP 67

Connectors and brackets

Brackets angled



Steel, galvanized	AMB8-A	AMB12-A	AMB18-A	AMB30-A
Stainless steel AISI316L	-	AMB12-A316L	AMB18-A316L	-
Used for	M8 sensors	M12 sensors	M18 sensors	M30 sensors
Description	Mounting bracket	Mounting bracketd	Mounting bracket	Mounting bracket

Brackets straight



Steel, galvanized	AMB8-S	AMB12-S	AMB18-S	AMB30-S
Stainless steel AISI316L		AMB12-S316L	AMB18-S316L	-
Used for	M8 sensors	M12 sensors	M18 sensors	M30 sensors
Description	Mounting bracket	Mounting bracket	Mounting bracket	Mounting bracket

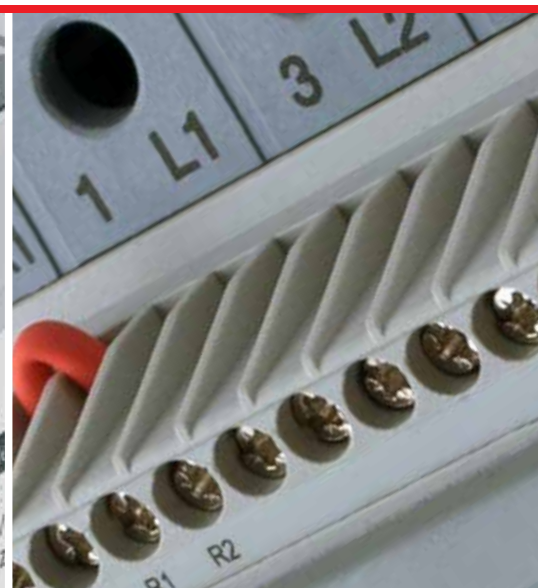



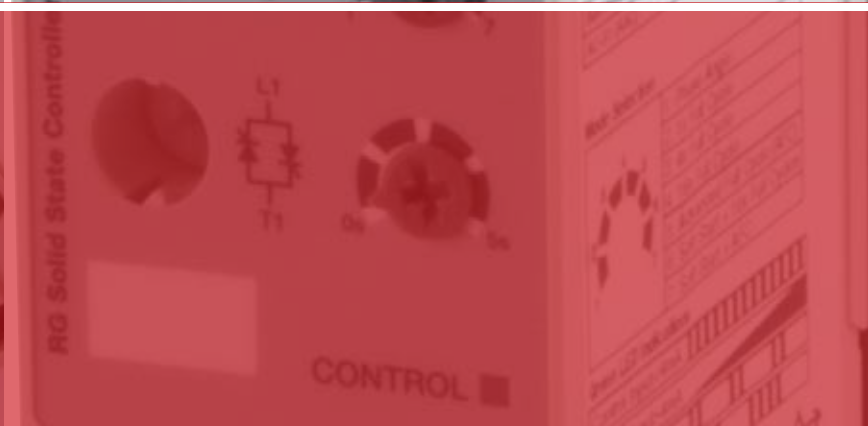
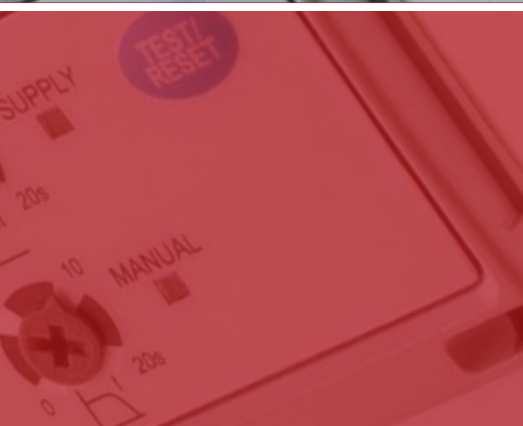

Switches



Solid state relays	108
Solid state relays accessories	143
Soft starters	148
Motor protection relays	152
Variable frequency drives	154
Limit switches	157
Electromechanical relays	166
Sockets for electromechanical relays	171

Solid state relays PCB type, 1-phase



	AC output switching			DC output switching
Types	RP1A - RP1B 3/5/5.5 AAC	RP..10 10 AAC	RAP 3/5 AAC	RP1D 1/4/8 ADC
PCB mounting SSRs, AC and DC operating. Rated isolation voltage ≥ 4000 Vrms				
Dimensions H x W x D (mm)	25.4 x 43 x 10.5	37 x 43 x 22	25.4 x 43 x 10.5	25.4 x 43 x 10.5
Features	Standard AC switching SSR	With integral heatsink	LED indication High blocking voltage	DC switching SSR
Input specifications				
Control input range	3-32 VDC [RP1A23..] 3-32 VDC [RP1A40..] 4-32 VDC [RP1A48..] 15-32 VAC [RP1A23A6]	3-32 VDC [RP1A23..] 4-32 VDC [RP1A40..] 4-32 VDC [RP1A48..]	3.5-40 VDC [RAP40..] 4.5-40 VDC [RAP48..]	4.5 - 32 VDC
Max. input current	10 mA	10 mA	12 mA	15 mA
Output specifications				
Rated operational current				DC1: 1/4/8 ADC
AC 51 @ Ta=25°C	3 A [RP1...3] 5 A [RP1...5] 5.5 A [RP1...6]	10 A	3 A [RAP...A3] 5 A [RAP...A5]	
AC 53a @ Ta=25°C	2 A [RP1...3] 3 A [RP1...5] 5 A [RP1...6]	7 A	2.5 A [RAP...A3] 3 A [RAP...A5]	
Min. operational current	20 mA	10 mA	20 mA	1 mADC
Non rep. surge current (t=20 ms)	65 A _p [RP1...3] 80 A _p [RP1...5] 250 A _p [RP1...6]	250 A _p	60 A _p [RAP...A3] 90 A _p [RAP...A5]	
Off-state leakage current	≤ 1 mA	≤ 3 mA	≤ 1 mA	0.01 mADC
I ² t for fusing (t=10 ms)	20 A ² s [RP1...3] 50 A ² s [RP1...5] 340 A ² s [RP1...6]	340 A ² s	18 A ² s [RAP...A3] 40 A ² s [RAP...A5]	
Critical dV/dt off-state	250 V/ μ s [RP1...3] 500 V/ μ s [RP1...5] 500 V/ μ s [RP1...6]	1000 V/ μ s	100 V/ μ s	
General specifications				
Operational voltage range	12-265 Vrms [RP1A23..] 20-440 Vrms [RP1A40..] 20-530 Vrms [RP1A48..]	12-265 Vrms [RP1A23..] 20-440 Vrms [RP1A40..] 20-530 Vrms [RP1A48..]	10-440 Vrms [RAP40..] 20-530 Vrms [RAP48..]	1- 60 VDC [RP1D060...] 1 - 350 VDC [RP1D350...]
Blocking voltage	650 V _p [RP1A23..] 850 V _p [RP1A40..] 1000 V _p [RP1A48..]	650 V _p [RP1A23..] 850 V _p [RP1A40..] 1000 V _p [RP1A48..]	1000 V _p [RAP40..] 1200 V _p [RAP48..]	
Power factor	0.5	0.5	0.2	0.5
Operating temperature	-20°C to +70°C	-30°C to +80°C	-20°C to +70°C	-20°C to +80°C
Terminals	4 pins x \varnothing 0.1 mm	4 pins x \varnothing 0.1 mm	4 pins x \varnothing 0.1 mm	4 pins x \varnothing 0.1 mm
Approvals/Marks	CE - UR - cUR - VDE	CE - UR - cUR	CE - UR - CSA - VDE	CE - UR - cUR
References				
	3 A	10 A	3 A	1 A
	RP1A23D3	RP1A23D10	RAP40A3	RP1D350D1
	RP1A40D3	RP1A40D10	RAP48A3	
	RP1A48D3	RP1A48D10		4 A
	5 A		5 A	RP1D060D4
	RP1A23D5		RAP40A5	
	RP1A40D5		RAP48A5	8 A
	RP1A48D5			RP1D060D8
	5.5 A			
	RP1A23D6			
	RP1A23A6			
	RP1A40D6			
	RP1A48D6			

* Other options available on request: Instant-on switching (RP1B..), see Accessories for DIN-rail adaptor.

CARLO GAVAZZI Automation Components. Specifications are subject to change without notice. Illustrations are for example only.

Solid state relays, 1-phase

Slimline - AC output switching

Types	RGS1A..KKE 25/50/75/90 AAC	RGS1A..KGE 50/90 AAC	RGS1A..MKE 25/50/90 AAC
Single phase, chassis mounting with LED for control status indication, IP20 protection, 45-65 Hz operating frequency, ≥ 4000 VACrms isolation voltage, 100 kArms short circuit current rating, certified motor ratings			
Dimensions (mm)	90 x 17.8 x 50.6	90 x 17.8 x 50.6	90 x 17.8 x 63.6
Features	17.8 mm wide solid state relay with integrated varistor on output, AC or DC control range, screw terminals with captivated clamp for power and control connections, E-type layout	17.8 mm wide solid state relay with integrated varistor on output, AC or DC control range, box clamp for power connections (up to 25 mm ² /AWG3), screw for control connections, E-type layout	17.8 mm wide solid state relay with integrated varistor on output, AC or DC control range, screw terminals with captivated clamp for power connections and pluggable spring for control, E-type layout
Input specifications			
Control input range	3-32 VDC [RG.23D..] / 4-32 VDC [RG.60D..] 20-275 VAC, 24-190 VDC [RG..A.]	4-32 VDC [RG..D..] 20-275 VAC, 24-190 VDC [RG..A.]	3-32 VDC [RG..23D..], 4-32 VDC [RG..60D..] 20-275 VAC, 24-190 VDC [RG..A.]
Max. input current	11 mADC [RG..D..] 30 mAAC [RG..A.]	11 mADC [RG..D..] 30 mAAC [RG..A.]	11 mADC [RG..D..] 30 mAAC [RG..A.]
Output specifications			
Rated operational current AC-51 @ Ta=40°C	25 AAC [RG..25] / 50 AAC [RG..50/51] 75 AAC [RG..75] / 90 AAC [RG..90/91/92]	50 AAC [RG..50] 90 AAC [RG..92]	25 AAC [RG..25] / 50 AAC [RG..50] 90 AAC [RG..90/92]
AC-53a @ Ta=40°C	5 AAC [RG..25] / 10 AAC [RG..50/51] 14.8 AAC [RG..75] / 18 AAC [RG..90/91/92]	10 AAC [RG..50] 18 AAC [RG..92]	5 AAC [RG..25] / 10 AAC [RG..50] 18 AAC [RG..90/92]
Min. operational current	150 mAAC [RG..25] / 250 mAAC [RG..50/51] 400 mAAC [RG..75] / 500 mAAC [RG..90/91/92]	250 mAAC [RG..50] 500 mAAC [RG..92]	150 mAAC [RG..25] / 250 mAAC [RG..50] 500 mAAC [RG..90/92]
Non rep. surge current (t=10 ms)	325 Ap [RG..25] / 600 Ap [RG..50/51] 800 Ap [RG..75] / 1150 Ap [RG..90/91] 1900 Ap [RGS..92]	600 Ap [RG..50] 1900 Ap [RG..92]	325 Ap [RG..25] / 600 Ap [RG..50] 1150 Ap [RG..90] / 1900 Ap [RG..92]
Max. off-state leak current	3 mAAC	3 mAAC	3 mAAC
I ² t for fusing (t=10 ms)	525 A ² s [RG..25] / 1800 A ² s [RG..50/51] 3200 A ² s [RG..75] / 6600 A ² s [RG..90/91] 18000 A ² s [RGS..92]	1800 A ² s [RG..50] 18000 A ² s [RG..92]	525 A ² s [RG..25] / 1800 A ² s [RG..50] 6600 A ² s [RG..90] / 18000 A ² s [RG..92]
Critical dV/dt (@ Tj init = 40°C)	1000 V/μs	1000 V/μs	1000 V/μs
General specifications			
Operational voltage range	24-240 VAC +10% [RG.23..] 42-600 VAC +10% [RG.60...] 42-690 VAC + 10% [RG..69..]*	42-600 VAC +10%	24-240 VAC +10% [RG..23..] 42-600 VAC +10% [RG..60..]
Blocking voltage	800 Vp [RG..23..] 1200 Vp [RG..60..] 1600 Vp [RG..60..51/91]	1200 Vp	800 Vp [RG..23..] 1200 Vp [RG..60..]
Power factor	≥ 0.5 at rated voltage	≥ 0.5 at rated voltage	≥ 0.5 at rated voltage
Operating temperature	-40°C to 80°C	-40°C to +80°C	-40°C to +80°C
Approvals/Marks	CE - cURus - CSA - VDE	CE - cURus - CSA - VDE	CE - cURus - CSA - VDE
References			
230 VAC, 800 Vp	25 AAC: RGS1A23X25KKE		25 AAC: RGS1A23X25MKE
	50 AAC: RGS1A23X50KKE		50 AAC: RGS1A23X50MKE
	75 AAC: RGS1A23X75KKE		
600 VAC, 1200 Vp	25 AAC: RGS1A60X25KKE		25 AAC: RGS1A60X25MKE
	50 AAC: RGS1A60X50KKE	50 AAC: RGS1A60X50KGE	50 AAC: RGS1A60X50MKE
	75 AAC: RGS1A60X75KKE		
	90 AAC: RGS1A60X90KKE		90 AAC: RGS1A60X90MKE
	90 AAC: RGS1A60X92KKE	90 AAC: RGS1A60X92KGE	90 AAC: RGS1A60X92MKE
600 VAC, 1600 Vp	50 AAC: RGS1A60X51KKE		
	90 AAC: RGS1A60X91KKE		
690 VAC, 1600 Vp	90 AAC: RGS1A69X91KKE*		

X must be replaced with D for DC control 3-32 VDC, 4-32 VDC (for 600 VAC versions)



X must be replaced with A for AC control 20-275 VAC, 24-190 VDC

RGS1B.. models for Instant On (Random) switching are available on request

*690VAC variants are CE marked only and do not include a varistor across the output

Solid state relays, 1-phase

Slimline - AC output switching

Types	RGS1A..MGE 50/90 AAC	RGS1A..KGU 20/30 AAC	RGS1A..DIN 10/12 AAC
Single phase, chassis mounting with LED for control status indication, IP20 protection, 45-65 Hz operating frequency, ≥ 4000 VACrms isolation voltage, 100 kArms short circuit current rating, certified motor ratings			

Dimensions (mm)	90 x 17.8 x 63.6	90 x 17.8 x 50.6	106 x 17.8 x 65
Features	17.8 mm wide solid state relay with integrated varistor on output, AC or DC control range, box clamps for power connections (25 mm ² / AWG3) and pluggable spring for control, E-type layout	17.8 mm wide solid state relay with integrated varistor on output, AC or DC control range, box clamps for power and control connections, U-type layout	17.8 mm wide solid state relay mounted on DIN mountable module

Input specifications

Control input range	4-32 VDC [RG..D..] 20-275 VAC, 24-190 VDC [RG..A..]	3-32 VDC [RG..23D..] 4-32 VDC [RG..60D..] 20-275 VAC, 24-190 VDC [RG..A..]	3-32 VDC [RG..23D..] 4-32 VDC [RG..60D..] 20-275 VAC, 24-190 VDC [RG..A..]
Max. input current	11 mADC [RG..D..] 30 mAAC [RG..A..]	11 mADC [RG..D..] 30 mAAC [RG..A..]	11 mADC [RG..D..] 30 mAAC [RG..A..]

Output specifications

Rated operational current AC-51 @ Ta=40°C	50 AAC [RG..50] 90 AAC [RG..92]	20 AAC [RG..20] 30 AAC [RG..30]	10 AAC [RG..20/25..DIN] 12 AAC [RG..50/90..DIN]
AC-53a @ Ta=40°C	10 AAC [RG..50] 18 AAC [RG..92]	5 AAC [RG..20] 8 AAC [RG..30]	5 AAC [RG..20/25..DIN] 5 AAC [RG..50/90..DIN]
Min. operational current	250 mAAC [RG..50] 500 mAAC [RG..92]	150 mAAC [RG..20] 250 mAAC [RG..30]	150 mAAC [RG..20/25..DIN] 250 mAAC [RG..50..DIN] 400 mAAC [RG..90..DIN]
Non rep. surge current (t=10 ms)	600 Ap [RG..50] 1900 Ap [RG..92]	325 Ap [RG..20] 600 Ap [RG..30]	325 Ap [RG..20/25..DIN] 600 Ap [RG..50..DIN] 1150 Ap [RG..90..DIN]
Max. Off-state leak current	3 mAAC	3 mAAC	3 mAAC
I ² t for fusing (t=10 ms)	1800 A ² s [RG..50] 18000 A ² s [RG..92]	525 A ² s [RG..20] 1800 A ² s [RG..30]	525 A ² s [RG..20/25..DIN] 1800 A ² s [RG..50..DIN] 6600 A ² s [RG..90..DIN]
Critical dV/dt (@ Tj init=40°C)	1000 V/μs	1000 V/μs	1000 V/μs

General specifications

Operational voltage range	42-600 VAC +10%	24-240 VAC +10% [RG..23..] 42-600 VAC +10% [RG..60..]	24-240 VAC +10% [RG..23..] 42-600 VAC +10% [RG..60..]
Blocking voltage	1200 Vp	800 Vp [RGS..23..] 1200 Vp [RGS..60..]	800 Vp [RG..23..] 1200 Vp [RG..60..]
Power factor	≥ 0.5 at rated voltage	≥ 0.5 at rated voltage	≥ 0.5 at rated voltage
Operating temperature	-40°C to +80°C	-40°C to +80°C	-40°C to +80°C
Approvals/Marks	CE - cURus - CSA - VDE	CE - cURus - CSA - VDE	CE - cURus - CSA - VDE

References



230 VAC, 800 Vp, E-type		10 AAC: RGS1A23X25KKEDIN 12 AAC: RGS1A23X50KKEDIN
	50 AAC: RGS1A60X50MGE 90 AAC: RGS1A60X92MGE	10 AAC: RGS1A60X25KKEDIN 12 AAC: RGS1A60X50KKEDIN 12 AAC: RGS1A60D90KKEDIN
230 VAC, 800 Vp, U-type		20 AAC: RGS1A23X20KGU 30 AAC: RGS1A23X30KGU
600 VAC, 1200 Vp, U-type		20 AAC: RGS1A60X20KGU 30 AAC: RGS1A60X30KGU

X must be replaced with D for DC control 3-32 VDC, 4-32 VDC (for 600 VAC versions)
 X must be replaced with A for AC control 20-275 VAC, 24-190 VDC
 RGS1B.. models for Instant On (Random) switching are available on request

Solid state relays, 1-phase

Slimline - DC output switching





Slimline - AC output switching Integrated current measurement

Types	RGS1D..KKE 15/25 ADC	RGS1S..EP 20/30/90 AAC	RGS1S..UP 65 AAC
Single phase, chassis mounting industrial relays with LED for control status indication and IP20 protection, Rated isolation voltage ≥ 4000 Vrms, 100 kArms short circuit current rating for AC switching versions			
Dimensions HxWxD (mm)	90 x 17.8 x 50.6	90 x 22.5 x 78	90 x 35.6 x 78
Features	17.8 mm wide solid state relay with IGBT output, integrated free wheeling diode, DC control voltage, screw terminals with captivated clamp, E-type layout	22.5 mm wide solid-state relay with thyristor output, integrated varistor, DC control, local or remote TEACH, detection of partial load failure (1/6), SSR and load malfunction, SSR overheat protection.	35 mm wide solid-state relay with thyristor output, integrated varistor, DC control, local or remote TEACH, detection of partial load failure (1/6), SSR and load malfunction, SSR overheat protection.
Input specifications			
Control input range	4.5-32 VDC	4-32 VDC	4-32 VDC
Max. input current	13.7 mAADC	10 mAADC at 24 VDC	10 mAADC at 24 VDC
Supply voltage		24 VDC -15%, +20%	24 VDC -15%, +20%
Max. supply current		50 mAADC	50 mAADC
Alarm specifications			
Output type		NC PNP open collector max. 35 VDC / 50 mA	NC PNP open collector max. 35 VDC / 50 mA
Alarm Indication		Red LED (flash rate)	Red LED (flash rate)
Output specifications			
Rated operational current AC-51 @ Ta=40°C		20 AAC [RGS1S..20] 30 AAC [RGS1S..30 / 31] 90 AAC [RGS1S..92]	65 AAC
DC Rated operational current	15 ADC [RGS1D..15.] 25 ADC [RGS1D..25.]		
Minimum TEACH / operational current	20 mA	1.2 AAC [RGS1S..20/30/31] 5 AAC [RGS1S..92]	5 AAC
Minimum partial load current		0.2 AAC [RGS1S..20/30/31] 0.83 AAC [RGS1S..92]	0.83 AAC
Detectable partial load failure		>16.67% from current setpoint	>16.67% from current setpoint
Non rep. surge current (I _{tsm}) (t=10 ms)	200 ADC [10µs]	325 A _p [RGS1S..20] - 600 A _p [RGS1S..30] 1150 A _p [RGS1S..31] - 1900 A _p [RGS1S..92]	1900 A _p
Max. Off-state leak current	1.5 mAADC	3 mAAC	3 mAAC
I ² t for fusing (t=10 ms)		525 A ² s [RGS1S..20] - 1800 A ² s [RGS1S..30] 6600 A ² s [RGS1S..31] - 18000 A ² s [RGS1S..92]	18000 A ² s
Critical dV/dt (@ T _j init = 40°C)		1000 V/µs	1000 V/µs
General specifications			
Operational voltage range	24-1000 VDC [CE] 24-600 VDC [UL508]	42-600 VAC +10%	42-600 VAC +10%
Blocking voltage	1200 VDC	1200 V _p	1200 V _p
Power factor		≥ 0.9 at rated voltage	≥ 0.9 at rated voltage
Operating temperature	-40°C to +80°C	-25°C to +70°C	-25°C to +70°C
Approvals/Marks	CE - cURus - CSA	CE - cURus - CSA	CE - cURus - CSA
References			
1000 VDC	15 ADC: RGS1D1000D15KKE 25 ADC: RGS1D1000D25KKE		
600 VAC, 525 A ² s, E-type		20 AAC: RGS1S60D20GKEP	
600 VAC, 1800 A ² s, E-type		30 AAC: RGS1S60D30GKEP	
600 VAC, 6600 A ² s, E-type		30 AAC: RGS1S60D31GKEP	
600 VAC, 18000 A ² s, E-type		90 AAC: RGS1S60D92GGEP	
600 VAC, 18000 A ² s, U-type			65 AAC: RGS1S60D61GGUP

KK = screws for control terminals, screws for power terminals
GK = box clamps for control terminals, screws for power terminals
GG = box clamps for control terminals, box clamps for power terminals

CARLO GAVAZZI Automation Components. Specifications are subject to change without notice. Illustrations are for example only.





Solid state relays, 1-phase

Types	Slimline - Soft start switching		Slimline - Proportional switching controllers	
	RGS1P..K.. 50 AAC	RGS1P..K.. 90 AAC	RGS1P..AA.. / V.. 50 AAC	RGS1P..AA.. / V.. 90 AAC
Single phase, chassis mounting industrial relays with integrated overvoltage protection, LED for control and load status indication, IP20 protection, rated isolation voltage ≥ 4000 Vrms, 100 kArms short circuit current rating				
Dimensions HxWxD (mm)	90 x 35.8 x 51	90 x 35.8 x 51	90 x 35.8 x 51	90 x 35.8 x 51
Features	DC control input solid state relay with soft starting feature for short wave infrared heaters.	DC control input solid state relay with soft starting feature for short wave infrared heaters.	Analog input (current or voltage), selectable modes for output switching - phase angle, full cycle distributed firing, advanced full cycle and soft starting	Analog input (current or voltage), selectable modes for output switching - phase angle, full cycle distributed firing, advanced full cycle and soft starting
Supply specifications				
Supply voltage	24 VDC -15%, +20% 24 VAC -15%, +15%	24 VDC -15%, +20% 24 VAC -15%, +15%	24 VDC -15%, +20% (RG..V.ED) 24 VAC -15%, +15% (RG..V.ED) 90-250 VAC (RG..V.EA)	24 VDC -15%, +20% (RG..V.ED) 24 VAC -15%, +15% (RG..V.ED) 90-250 VAC (RG..V.EA)
Max. supply current	30 mA	30 mA	30 mA (RG..V.ED) 14 mA (RG..V.EA)	30 mA (RG..V.ED) 14 mA (RG..V.EA)
Control specifications				
Control input range	19.2 - 28.8 VDC	19.2 - 28.8 VDC	4-20 mA (RG..AA..) 0-10V, 0-5V, 1-5V, POT (RG..V.)	4-20 mA (RG..AA..) 0-10V, 0-5V, 1-5V, POT (RG..V.)
Input impedance	100 k Ω	100 k Ω	500 Ω (RG..AA..) 100 k Ω (RG..V.)	500 Ω (RG..AA..) 100 k Ω (RG..V.)
Output specifications				
Rated operational current AC-51 @ 40°C	50 AAC	90 AAC	50 AAC	90 AAC
Minimum operational current	250 mAAC	500 mAAC	250 mAAC	500 mAAC
Non rep. surge current (I _{tsm}) (t=10 ms)	600 Ap	1900 Ap	600 Ap	1900 Ap
I ² t for fusing (t=10 ms)	1800 A ² s	18000 A ² s	1800 A ² s	18000 A ² s
Max. Off-state leakage current	5 mAAC	5 mAAC	5 mAAC	5 mAAC
Critical dV/dt (@ T _j init = 40°C)	1000 V/ μ s	1000 V/ μ s	1000 V/ μ s	1000 V/ μ s
General specifications				
Operational voltage range	85 - 265 VAC (RGS1P23..) 190 - 550 VAC (RGS1P48..) 410 - 660 VAC (RGS1P60..)	85 - 265 VAC (RGS1P23..) 190 - 550 VAC (RGS1P48..) 410 - 660 VAC (RGS1P60..)	85 - 265 VAC (RGS1P23..) 190 - 550 VAC (RGS1P48..) 410 - 660 VAC (RGS1P60..)	85 - 265 VAC (RGS1P23..) 190 - 550 VAC (RGS1P48..) 410 - 660 VAC (RGS1P60..)
Blocking voltage	800 V _P (RGS1P23..) 1200 V _P (RGS1P48..) 1200 V _P (RGS1P60..)	800 V _P (RGS1P23..) 1200 V _P (RGS1P48..) 1200 V _P (RGS1P60..)	800 V _P (RGS1P23..) 1200 V _P (RGS1P48..) 1200 V _P (RGS1P60..)	800 V _P (RGS1P23..) 1200 V _P (RGS1P48..) 1200 V _P (RGS1P60..)
Power factor	> 0.7	> 0.7	> 0.7	> 0.7
Terminals	Screw with captive clamp	Box clamp	Screw with captive clamp	Box clamp
Operating temperature	-40°C to +70°C	-40°C to +70°C	-40°C to +70°C	-40°C to +70°C
Approvals/Marks	CE - cURus - CSA	CE - cURus - CSA	CE - cURus - CSA	CE - cURus - CSA
References				
External supply 24 VDC/AC				
Operational output 85 - 265 VAC	RGS1P23K50ED	RGS1P23K92ED		
Operational output 190 - 550 VAC	RGS1P48K50ED	RGS1P48K92ED		
Operational output 410 - 660 VAC	RGS1P60K50ED	RGS1P60K92ED		
Control input				
4-20 mA			RGS1PxxAA50E	RGS1PxxAA92E
0-10 VDC, 0-5 VDC, 1-5 VDC, POT				
External supply 24 VDC/AC			RGS1PxxV50ED	RGS1PxxV92ED
External supply 90-250 VAC			RGS1PxxV50EA	RGS1PxxV92EA

xx = 23 for operational voltage range 85 - 265 VAC
 xx = 48 for operational voltage range 190 - 550 VAC
 xx = 60 for operational voltage range 410 - 660 VAC

Solid state relays, 1-phase

Industrial housing - AC output switching

Types	RF1A 25 AAC	RS1A 10/25/40 AAC	RAM1A 25/50/75/100/125 AAC	RAM1A..G 25/50/100/125 AAC
Single phase, chassis mounting, industrial relays with LED status indication and IP 20 protection. AC operating frequency range 45-65 Hz. Rated isolation voltage ≥ 4000 Vrms				
Dimensions HxWxD (mm)	36 x 21 x 24	58.2 x 44.8 x 28.8	58.2 x 44.8 x 28.8	58.2 x 44.8 x 28.8
Features	Zero Cross or Instant ON, Built-in transit, VDE, Glow wire acc. to IEC/EN 60335-1	Zero Cross, Ideal for Ohmic loads	Zero Cross or Instant ON, Built-in snubber, VDE	Zero Cross, Built-in varistor, VDE, Glow wire acc. to IEC/EN 60335-1

Input specifications

Control input range	4.25 - 9 VDC [RF1A..L] 9 - 18 VDC [RF1A..M] 18 - 28.8 VDC [RF1A..D]	3-32 VDC [RS1A23D] 4-32 VDC [RS1A....D] 18-36 VAC/DC [RS1A...LA] 80-130 VAC [RS1A..A1-] 200-260 VAC [RS1A..A2-] 360-440 VAC [RS1A..A4-]	3-32 VDC [RAM1A23D...] 4-32 VDC [RAM1A60D...] 20-280 VAC / 22-48 VDC [RAM1A..A.]	3-32 VDC [RAM1A23D..] 4-32 VDC [RAM1A60D..] 20-280 VAC / 22-48 VDC [RAM1A..A.]
Max. input current	15 mA [RF1A..L] 12 mA [RF1A..M] 12.5 mA [RF1A..D]	12 mA [RS1A..D] 15 mA [RS1A..LA] 13 mA [RS1A...A1- /A2- /A4-]	12 mA [RAM1A..D.] 20 mA [RAM1A..A.]	12 mA [RAM1A..D.] 20 mA [RAM1A..A.]

Output specifications

	RF1A	RS1A..10 / 25 / 40	RAM1A..25 / 50 / 75 / 100 / 125	RAM1A..25/50/51/100/125
Rated operational current				
AC 51 @ Ta=25°C	25 AAC	10 / 25 / 40 AAC	25 / 50 / 75 / 100 / 125 AAC	25 / 50 / 50 / 100 / 125 AAC
AC 53a @ Ta=25°C			5 / 15 / 17 / 20 / 30 AAC	5 / 15 / 15 / 20 / 30 AAC
Min. operational current	150 mAAC	150 / 150 / 250 mAAC	150 / 250 / 400 / 400 / 500 mAAC	150 / 250 / 400 / 400 / 500 mAAC
Non rep. surge current (t=10 ms)	325 Ap	100 / 325 / 600 Ap	325 / 600 / 800 / 1150 / 1900 Ap	325 / 600 / 800 / 1150 / 1900 Ap
Off-state leakage current	< 3 mA	< 3 mA	< 3 mA	< 3 mA
I ² t for fusing (t=10 ms)	525 A ² s	50 / 525 / 1800 A ² s	525 / 1800 / 3200 / 6600 / 18000 A ² s	525 / 1800 / 3200 / 6600 / 18000 A ² s
Critical dV/dt	1000 V/μs	500 V/μs	1000 V/μs	1000 V/μs

General specifications

Operational voltage range	24 - 280 VAC	42-265 VAC [RS1A23..] 42-440 VAC [RS1A40..] 42-530 VAC [RS1A48..]	24-265 VAC [RAM1A23..] 42-660 VAC [RAM1A60..] 42-760 VAC [RAM1A69..]	24-265 VAC [RAM1A23..] 42-660 VAC [RAM1A60..]
Blocking voltage	600Vp	650 Vp [RS1A23..] 850 Vp [RS1A40..] 1200 Vp [RS1A48..]	650 Vp [RAM1A23..] 1200 Vp [RAM1A60..] 1600 Vp [RAM1A69..]	650 Vp [RAM1A23..] 1200 Vp [RAM1A60..]
Power factor	≥ 0.9	≥ 0.95	≥ 0.5	≥ 0.5
Operating temperature	-30°C to +80°C	-20°C to +70°C	-40°C to +80°C	-40°C to +80°C
Terminals	FASTONS	Screw type with clamp	Screw type with clamp	Screw type with clamp
Approvals/Marks	CE - UR - CSA - VDE	CE - UR - CSA	CE - UR - CSA - CCC - VDE*	CE - UR - CSA - CCC - VDE

References



	25 AAC	10 / 25 / 40 AAC	25 / 50 / 75 / 100 / 125 AAC	25 / 50 / 100 / 125 AAC
230 VAC	RF1A23L25	RS1A23X10 (X = D, LA only)	RAM1A23DYY	RAM1A23DYYG
	RF1A23M25	RS1A23X25	RAM1A23AYY	RAM1A23AYYG
	RF1A23D25	RS1A23X40		
400 VAC		RS1A40X10 (X = D, LA only)		
		RS1A40X25		
		RS1A40X40		
480 VAC		RS1A48X10 (X = D, LA only)		
		RS1A48X25 (X = D, LA only)		
		RS1A48X40 (X = D, LA only)		
600 VAC			RAM1A60DYY	RAM1A60DYYG
			RAM1A60AYY	RAM1A60AYYG
690 VAC			RAM1A69DYY	
			RAM1A69AYY	

RF1B... RAM1B... Instant On switching versions available on request.
* 690 VAC CE marked only.

X = D for DC control = 3-32VDC (RS1A23..), 4-32VDC (RS1A40.., RS1A48..)
X = LA for AC control = 18-36VAC/DC
X = A1- for AC control = 80-130VAC (not available for RS1A40..)
X = A2- for AC control = 200-260VAC
X = A4- for AC control = 360-440VAC
YY = 25 for 25AAC
YY = 50 for 50AAC

YY = 51 for 50AAC high I²t (RAM1A60..G only)
YY = 75 for 75AAC
YY = 100 for 100AAC (not available for RAM1A23..G)
YY = 125 for 125AAC (not available for RAM1A23..G)

Solid state relays, 1-phase

	Industrial housing zero/instant ON switching	Industrial housing peak switching	Industrial housing phase angle switching
Types	RM1A 25/50/75/100 AAC	RM1C 25/50/75/100 AAC	RM1E 25/50/100 AAC
Single phase, chassis mounting, industrial relays with LED status indication and IP20 protection AC operating frequency range 45-65 Hz. Rated isolation voltage ≥ 4000 Vrms			
Dimensions HxWxD (mm)	58.2 x 44.8 x 28.8	58.2 x 44.8 x 28.8	58.2 x 44.8 x 28.8
Features	Zero Cross or Instant ON, Built-in varistor	Ideal for transformers	Analogue phase-angle control

Input specifications

Control input range	3-32 VDC [RM1A23D.] 4-32 VDC [RM1A60D.] 20-280 VAC/22-48 VDC [RM1A..A.] 4.25-36 VDC/4.25-27 VAC [RM1A..M.]	4.25-32 VDC	4-20 mA [RM1E..AA..] 0-10 VDC [RM1E..V..]
Max. input current	12 mA [RM1A..D.] 20 mA [RM1A..A.] 18 mA [RM1A..M.]	18 mA	0.15 mA [RM1E..V..]
Supply voltage range			24 VDC [RM1E..V..]
Max. supply input current			20 mA [RM1E..V..]

Output specifications

	RM1A..25 / 50 / 75 / 100	RM1C..25 / 50 / 75 / 100	RM1E..25 / 50 / 100
Rated operational current			
AC 51 @ Ta=25°C	25 / 50 / 75 / 100 AAC	25 / 50 / 75 / 100 AAC	25 / 50 / 100 AAC
AC 53a @ Ta=25°C	5 / 15 / 20 / 30 AAC		5 / 15 / 20 AAC
AC 56a @ Ta=25°C		10 / 20 / 25 / 30 AAC	
Min. operational current	150 / 250 / 400 / 500 mAAC	150 / 250 / 400 / 500 mAAC	150 / 250 / 400 mAAC
Non rep. surge current (t=10 ms)	325 / 600 / 1150 / 1900 Ap	325 / 600 / 1150 / 1900 Ap	325 / 600 / 1150 Ap
Off-state leakage current	< 3 mA	< 3 mA	< 3 mA
I ² t for fusing (t=10 ms)	525 / 1800 / 6600 / 18000 A ² s	525 / 1800 / 6600 / 18000 A ² s	525 / 1800 / 6600 A ² s

General specifications

Operational voltage range	24-265 VAC [RM1A23..] 42-440 VAC [RM1A40..] 42-530 VAC [RM1A48..] 42-660 VAC [RM1A60..]	100-440 VAC [RM1C40D.] 340-660 VAC [RM1C60D.]	90-280 VAC [RM1E23AA..] 340-460 VAC [RM1E40AA..] 200-550 VAC [RM1E48AA..] 410-660 VAC [RM1E60AA..] 90-265 VAC [RM1E23V..] 200-550 VAC [RM1E48V..] 410-660 VAC [RM1E60V..]
Blocking voltage	650 Vp [RM1A23..] 850 Vp [RM1A40..] 1200 Vp [RM1A48..] 1400 Vp [RM1A60..]	850 Vp [RM1C40D..] 1400 Vp [RM1C60D..]	650 Vp [RM1E23..] 850 Vp [RM1E40..] 1200 Vp [RM1E48..] 1400 Vp [RM1E60..]
Power factor	≥ 0.5	≥ 0.5	≥ 0.75
Operating temperature	-20°C to +70°C	-30°C to +80°C	-20°C to +70°C
Terminals	Screw type with clamp	Screw type with clamp	Screw type with clamp
Approvals/Marks	CE - UR - CSA - CCC	CE - UR - CSA	CE - UR - CSA

References 1-phase:

	25 / 50 / 75 / 100 AAC	25 / 50 / 75 / 100 AAC	25 / 50 / 100 AAC
230 Vrms	RM1A23XYY		RM1E23X25 (X = AA or V) RM1E23X50 (X = AA or V) RM1E23X100 (X = AA or V)
400 Vrms	RM1A40XYY	RM1C40D25 RM1C40D50 RM1C40D75	RM1E40AA25 RM1E40AA50 RM1E40AA100
480 Vrms	RM1A48XYY		RM1E48X25 (X = AA or V) RM1E48X50 (X = AA or V) RM1E48X100 (X = AA or V)
600 Vrms	RM1A60XYY	RM1C60D25 RM1C60D50 RM1C60D100	RM1E60X25 (X = AA or V) RM1E60X50 (X = AA or V) RM1E60X100 (X = AA or V)

RM1B.. Instant On switching versions available on request



X = D for DC control = 3-32VDC (RM1A23..), 4-32VDC (RM1A40.., RM1A48.., RM1A60..)
X = A for AC control = 20-280VAC / 22-48VDC

X = M for low AC control = 4.25-36VDC / 4.25-27VAC
YY = 25 for 25 AAC
YY = 50 for 50 AAC

YY = 75 for 75 AAC
YY = 100 for 100 AAC

Solid state relays, 1-phase

Industrial housing AC output switching

Types	RA 25/50/90/110 AAC	RA Sense 25/50/90/110 AAC	RA Low Noise 10/25 AAC
Single phase relays, chassis mounting, variants with special functions 2 Phase industrial relays			
Dimensions HxWxD (mm)	58.2 x 44.8 x 28.8	58.2 x 44.8 x 28.8	58.2 x 44.8 x 28.8
Features	General purpose	Detects supply and load failure	Complies with EN55022

Input Specifications

Control input range	3-32 VDC [RA..D..] 10-90 VAC / DC [RA..LA..] 90-280 VAC / DC [RA..HA..]	7-32 VDC	3-32 VDC
Max. input current	22 mA [RA..D..] 17 mA [RA..LA..] 6.5 mA [RA..HA..]	4 mA	32 mA
Control supply		20-32 VDC (40 mA)	
Alarm output	PNP NPN	VCC - 2 VDC (100 mA) 2 VDC (100 mA)	

Output specifications

Rated operational current			
AC 51 @ Ta=25°C	25 / 50 / 90 / 110 AAC	25 / 50 / 90 / 110 AAC	10 / 25 AAC
AC 53a @ Ta=25°C	5/15/ 20/30 AAC		
Min. operational current	20 mA	200 mArms	2 Arms
Non rep. surge current (t=10 ms)	325 Ap [RA..25.] 600 Ap [RA..50.] 1150 Ap [RA..90.] 1900 Ap [RA..110.]	325 Ap [RA..25..S] 600 Ap [RA..50..S] 1150 Ap [RA..90..S] 1900 Ap [RA..110..S]	90 Ap, t=20 ms [RA..10..L] 200 Ap, t=20 ms [RA..25..L]
Off-state leakage current	< 3 mA	< 6 mArms	< 1 mArms
I ² t for fusing (t=10 ms)	<525 A ² s [RA..25.] <1800 A ² s [RA..50.] <6600 A ² s [RA..90.] <18000 A ² s [RA..110.]	525 A ² s [RA..25..S] 1800A ² s [RA..50..S] 6600 A ² s [RA..90..S] 18000 A ² s [RA..110..S]	120 A ² s [RA..10..L] 200 A ² s [RA..25..L]

General specifications

Operational voltage range	24-280 Vrms [RA24.06..] 42-480 Vrms [RA44.08..] 42-530 Vrms [RA48.12..] 24-690 Vrms [RA60.16..]	60-140 Vrms [RA12..S] 170-250 Vrms [RA23..S] 150-440 Vrms [RA40..S] 180-530 Vrms [RA48..S]	180-265 Vrms [RA24..L] 340-530 Vrms [RA40..L]
Blocking voltage	<650 Vp [RA24.06..] <850 Vp [RA44.08..] <1200 Vp [RA48.12..] <1600 Vp [RA60.16..]	650 Vp [RA12..S] 650 Vp [RA23..S] 1000 Vp [RA40..S] 1200 Vp [RA48..S]	650 Vp [RA24..L] 850 Vp [RA40..L]
Power factor	≥ 0.5	≥ 0.5	1
Operating temperature	-20°C to +70°C	-20°C to +70°C	-20°C to +70°C
Terminals	Screw type with clamp	Screw / 5 way plug	Screw type with clamp
Approvals/Marks	CE - UR - CSA	CE - UR - CSA	CE - UR - CSA - VDE

References

	25 / 50 / 90 / 110 AAC	25 / 50 / 90 / 110 AAC	10 / 25 AAC
120 Vrms		RA12..06..S	
230 Vrms	RA24..-D..	RA23..06..S	RA2410-D06L
	RA24..LA..		RA2425-D06L
	RA24..HA..		
400 Vrms	RA44..-D..	RA40..10..S	RA4010-D08L
	RA44..LA..		RA4025-D08L
	RA44..HA..		
480 Vrms	RA48..-D..	RA48..12..S	
	RA48..LA..		
	RA48..HA..		
600 Vrms	RA60..-D..		

Solid state relays, 2-poles

Industrial housing AC output switching

Types	RA2A 25/40 AAC	RA2A..C 25/40 AAC
-------	--------------------------	-----------------------------

2-pole industrial solid state relays



Dimensions HxWxD (mm)	57.8 x 44.5 x 31.7	57.8 x 44.5 x 34.8
Features	Two independent poles, RA2A..M for inductive loads	Two independent poles with integrated varistor on output

Input specifications

Control input range	4.5-32 VDC	4.5-32 VDC
Max. input current	2 x 10 mA	2x 10 mA

Output specifications

Rated operational current		
AC 51 @ Ta=25°C	25 / 40 AAC per pole	25 / 40 AAC per pole
AC 53a @ Ta=25°C	5 / 15 AAC per pole [RA2A..M]	
Min. operational current	150 mArms [RA2A...25] 250 mArms [RA2A...40]	150 mArms [RA2A...25C] 250 mArms [RA2A...40C]
Non rep. surge current (t=10 ms)	325 Ap [RA2A..25] 600 Ap [RA2A..40]	325 Ap [RA2A...25C] 600 Ap [RA2A...40C]
Off-state leakage current	< 3 mArms	<3 mArms
I ² t for fusing (t=10 ms)	525 A ² s [RA2A..25] 1800 A ² s [RA2A..40]	525 A ² s [RA2A..25C] 1800 A ² s [RA2A..40C]

General specifications



Operational voltage range	24-265 Vrms [RA2A23..] / 42-440 Vrms [RA2A40..] 42-530 Vrms [RA2A48..] / 42-660 Vrms [RA2A60..]	24-265 Vrms [RA2A23..] 42-660 Vrms [RA2A60..]
Blocking voltage	650 Vp [RA2A23..] / 850 Vp [RA2A40..] 1200 Vp [RA2A48..] / 1200 Vp [RA2A60..]	650 Vp [RA2A23..] 1200 Vp [RA2A60..]
Power factor	≥0.95 [RA2A...] / ≥0.50 [RA2A...M]	≥ 0.95
Operating temperature	-20°C to +70°C	-20°C to +70°C
Terminals	FASTONS 6.35 mm	FASTONS 6.35 mm / 4 way plug
Approvals/Marks	CE - UR - CSA	CE - cURus

References

	25 / 40 AAC per pole	25 / 40 AAC per pole
230 Vrms	25 AAC: RA2A23D25	25 AAC: RA2A23D25C
	RA2A23D25M	40 AAC: RA2A23D40C
	40 AAC: RA2A23D40	
	RA2A23D40M	
400 Vrms	25 AAC: RA2A40D25	
	RA2A40D25M	
	40 AAC: RA2A40D40	
	RA2A40D40M	
480 Vrms	25 AAC: RA2A48D25	
	RA2A48D25M	
	40 AAC: RA2A48D40	
	RA2A48D40M	
600 Vrms	25 AAC: RA2A60D25	25 AAC: RA2A60D25C
	RA2A60D25M	40 AAC: RA2A60D40C
	40 AAC: RA2A60D40	
	RA2A60D40M	

Solid state relays, 2-poles



Industrial housing AC output switching

Types	RKD2..C / RK2..C 50 / 75 AAC	RKD2..P / RK2..P 50 / 75 AAC
2-pole industrial solid state relays		
Dimensions HxWxD (mm)	45 x 53 x 33	45 x 58 x 33 (w/o plug) 45 x 58 x 44 (incl. plug)
Features	Two poles with independent control (RKD2) or common control (RK2), control connection via connector pins	Two poles with independent control (RKD2) or common control (RK2), control connection via provided spring plug
Input specifications		
Control input range	4 - 32 VDC	4 - 32 VDC
Max. input current	2 x 12 mA (RKD2..) 1 x 24 mA (RK2..)	2 x 12 mA (RKD2..) 1 x 24 mA (RK2..)
Output specifications		
Rated operational current		
AC 51 @ Ta=25°C	50 AAC per pole [RK..50/51] 75 AAC per pole [RK..75]	50 AAC per pole [RK..50/51] 75 AAC per pole [RK..75]
AC 53a @ Ta=25°C	12 AAC	12 AAC
Min. operational current	250 mArms [RK..50] 400 mArms [RK..51/75]	250 mArms [RK..50] 400 mArms [RK..51/75]
Non rep. surge current (t=10 ms)	500 Ap [RK..50] 775 Ap [RK..51] 1400 Ap [RK..75]	500 Ap [RK..50] 775 Ap [RK..51] 1400 Ap [RK..75]
Off-state leakage current	≤ 3 mArms	≤ 3 mArms
I ² t for fusing (t=10 ms)	1500 A ² s [RK..50] 3000 A ² s [RK..51] 9800 A ² s [RK..75]	1500 A ² s [RK..50] 3000 A ² s [RK..51] 9800 A ² s [RK..75]
General specifications		
Operational voltage range	24 - 265 Vrms [RK..23..] 42 - 660 Vrms [RK..60]	24 - 265 Vrms [RK..23] 42 - 660 Vrms [RK..60]
Blocking voltage	600 Vp [RK..23..] 1200 Vp [RK..60..]	600 Vp [RK..23..] 1200 Vp [RK..60..]
Power factor	≥ 0.5	≥ 0.5
Operating temperature	-40°C to +80°C	-40°C to +80°C
Terminals	M4 screw / Control pins	M4 screw / Plug terminal
Approvals/Marks	CE - UR - CSA - VDE	CE - UR - CSA - VDE
References		
	50 / 75 AAC per pole	50 / 75 AAC per pole
230 Vrms	50 AAC: RKD2A23D50C	50 AAC: RKD2A23D50P
	50 AAC: RKD2A23D51C	50 AAC: RKD2A23D51P
	75 AAC: RKD2A23D75C	75 AAC: RKD2A23D75P
600 Vrms	50 AAC: RKX2Y60D50C	50 AAC: RKX2Y60D50P
	50 AAC: RKX2A60D51C	50 AAC: RKX2A60D51P
	75 AAC: RKX2Y60D75C	75 AAC: RKX2Y60D75P

X = must be replaced with 'D' for dual control, blank for common control

Y = must be replaced with 'A' for zero cross switching, 'B' for instant on switching



Solid state relays, 1 / 3-phase

	Industrial housing DC switching	Industrial housing 3-phase switching
Types	RD 1/5 ADC	RZ3A 25/55/75 AAC
Single phase and 3-phase industrial relays		
Dimensions HxWxD (mm)	58.2 x 44.8 x 28.8	74 x 103 x 41
Features	Ideal for DC valve coils	3-phase switching
Input Specifications		
Control input range	3-32 VDC	4-32 VDC [RZ3A..D.] 24-275 Vrms [RZ3A..A.]
Max. input current	32 mA	23 / 15 mA
Output specifications		
Rated operational current		
AC 51 @ Ta=25°C	DC1: 1 A / 5 A	25 / 55 / 75 AAC
AC 53a @ Ta=25°C		5 / 15 / 20 AAC
Min. operational current	1 mA	150 mArms [RZ3..25] 250 mArms [RZ3..55] 400 mArms [RZ3..75]
Non rep. surge current (t=10 ms)		325 Ap [RZ3A..25..] 600 Ap [RZ3A..55..] 1150 Ap [RZ3A..75..]
Off-state leakage current	< 1 mA	< 3 mA
I ² t for fusing (t=10 ms)		525 A ² s [RZ3A..25..] 1800 A ² s [RZ3A..55..] 6600 A ² s [RZ3A..75..]
General specifications		
Operational voltage range	3-60 VDC [RD0605..D] 3-200 VDC [RD2001..D] 3-350 VDC [RD3501..D]	24-440 Vrms [RZ3A40..] 42-530 Vrms [RZ3A48..] 42-660 Vrms [RZ3A60..]
Blocking voltage		<850 Vp [RZ3A40..] <1200 Vp [RZ3A48..] <1600 Vp [RZ3A60..]
Operating temperature	-20°C to +70°C	-30°C to +80°C
Terminals	Screw type with clamp	Screw type with clamp
Approvals/Marks	CE - CSA	CE - UR - CSA
References		
	1 / 5 ADC	25 / 55 / 75 AAC per pole
230 Vrms	200 VDC: RD2001-D 350 VDC: RD3501-D	RZ3A40D..* RZ3A40A..*
400 Vrms	60 VDC: RD0605-D	RZ3A48D..* RZ3A48A..*
480 Vrms		RZ3A60D..* RZ3A60A..*
600 Vrms		RZ3A60A..*

* Add suffix 'P' for additional integrated Over Temperature Protection

Solid state relays, 1 / 3-phase

AC output switching - Hybrid relays for DIN rail mounting

Types	RMD1H 20 AAC	RMD2H 30/40 AAC	RMD3H 30/40 AAC
Hybrid relays. AC operating frequency range 45-65 Hz.			

Dimensions HxWxD (mm)	81 x 17.5 x 67.2	97 x 140.7 x 50.7	97 x 140.7 x 50.7
Features	Hybrid relay	2 pole switching hybrid relay	3 pole switching hybrid relay

Input specifications

Control input range	4-32 VDC [RMD...D20] 24-275 VAC [RMD...A20]	24 VAC/DC +10/-15% [RMD2..LA..] 120 VAC/DC +10/-15% [RMD2..MA..] 240 VAC/DC +10/-15% [RMD2..HA..]	24 VAC/DC +10/-15% [RMD3..LA..] 120 VAC/DC +10/-15% [RMD3..MA..] 240 VAC/DC +10/-15% [RMD3..HA..]
Max. input current	5 mA [RMD..D20] 3 mA [RMD..A20]	400 mA	400 mA

Output specifications

Rated operational current			
AC 51 @ Ta=25°C	20 AAC	30 AAC [RMD2..30] 40 AAC [RMD2..40]	30 AAC [RMD3..30] 40 AAC [RMD3..40]
Min. operational current	100 mA	150 mA	150 mA

General specifications



Operational voltage range	195-253 Vrms	240 VAC -15% /+10% [RMD..24..] 277 VAC -15% /+10% [RMD..48..]	240 VAC -15% /+10% [RMD..24..] 277 VAC -15% /+10% [RMD..48..] 480 VAC + N [RMD..48..]
Power factor	≥ 0.9	≥ 0.9 at rated voltage	≥ 0.9 at rated voltage
Operating temperature	-5°C to +55°C	0°C to 70°C	0°C to 70°C
Terminals	Box clamp	Input 6.35 mm FASTON, Output screw	Input 6.35 mm FASTON, Output screw
Approvals/Marks	CE - cURus	CE - cURus	CE - cURus

References

	20 AAC	30 AAC	30 AAC
	RMD1H23D20	RMD2H24LA30	RMD3H24LA30
	RMD1H23A20	RMD2H24MA30	RMD3H24MA30
		RMD2H24HA30	RMD3H24HA30
		40 AAC	RMD3H48LA30
		RMD2H24LA40	RMD3H48MA30
		RMD2H24MA40	RMD3H48HA30
		RMD2H24HA40	40 AAC
			RMD3H24LA40
			RMD3H24MA40
			RMD3H24HA40
			RMD3H48LA40
			RMD3H48MA40
			RMD3H48HA40

Solid state contactors, 1-phase



Ready for use design - DIN rail mounting, AC output switching

Types	RGC/RGH1A..15KKE 20 AAC	RGC1A..25KKE 25 AAC	RGC/RGH1A..30KKE 30 AAC
Single phase, semiconductor contactors with integrated heatsink, LED indication and IP20 protection, AC operating frequency 45-65 Hz, rated isolation voltage ≥ 4000 Vrms, 100 kArms short circuit current rating, motor ratings according to UL508			
Dimensions HxWxD (mm)	110 x 17.8 x 103.5	110 x 17.8 x 103.5	110 x 22.5 x 141
Features	17.8 mm wide solid state contactor, integrated output varistor, DC or AC control voltage, screw terminals for power and control, E-type layout	17.8 mm wide solid state contactor, integrated output varistor, DC or AC control voltage, screw terminals for power and control, E-type layout	22.5 mm wide solid state contactor, integrated output varistor, DC or AC control voltage, screw terminals for power and control, E-type layout
Input specifications			
Control input range	3-32 VDC [RG.23D.] 4-32 VDC [RG.60D.] 20-275 VAC, 24-190 VDC [RG..A.]	3-32 VDC [RG.23D.] 4-32 VDC [RG.60D.] 20-275 VAC, 24-190 VDC [RG..A.]	3-32 VDC [RG.23D.] 4-32 VDC [RG.60D.] 20-275 VAC, 24-190 VDC [RG..A.]
Max. input current	11 mADC [RG..D.] 30 mAAC [RG..A.]	11 mADC [RG..D.] 30 mAAC [RG..A.]	11 mADC [RG..D.] 30 mAAC [RG..A.]
Output specifications			
Rated operational current AC 51 @ Ta=40°C	20 AAC	25 AAC	30 AAC
AC 53a @ Ta=40°C	5 AAC	5 AAC	8 AAC [RGC..30.] 10 AAC [RGH..31.]
Min. operational current	150 mA [RGC..15.] 400 mA [RGH..15.]	250 mA	250 mA [RGC..30.] 400 mA [RGH..31.]
Non rep. surge current (t=10 ms)	325 Ap [RGC..15.] 1150 Ap [RGH..15.]	600 Ap	600 Ap [RGC..30.] 1150 Ap [RGH..31.]
Off-state leakage current	3 mAAC	3 mAAC	3 mAAC
I ² t for fusing (t=10 ms)	525 A ² s [RGC..15.] 6600 A ² s [RGH..15.]	1800 A ² s	1800 A ² s [RGC..30.] 6600 A ² s [RGH..31.]
Critical dV/dt (@ Tj init=40°C)	1000 V/μs	1000 V/μs	1000 V/μs
General specifications			
Operational voltage range	24-240 VAC +10% [RG.23..] 42-600 VAC +10% [RG.60..]	24-240 VAC +10% [RG.23..] 42-600 VAC +10% [RG.60..]	24-240 VAC +10% [RG.23..] 42-600 VAC +10% [RG.60..]
Blocking voltage	800 Vp [RGC.23.] 1200 Vp [RGC.60.] 1600 Vp [RGH.60.]	800 Vp [RGC.23.] 1200 Vp [RGC.60.]	800 Vp [RGC.23.] 1200 Vp [RGC.60.] 1600 Vp [RGH.60.]
Power factor	≥ 0.5 at rated voltage	≥ 0.5 at rated voltage	≥ 0.5 at rated voltage
Operating temperature	-40°C to +80°C	-40°C to +80°C	-40°C to +80°C
Approvals/Marks	CE - cULus - VDE - GL [RGC..15.]	CE - cULus - VDE - GL	CE - cULus - VDE - GL [RGC..30.]
References			
DC control voltage			
230 VAC, 800 Vp	RGC1A23D15KKE	RGC1A23D25KKE	RGC1A23D30KKE
600 VAC, 1200 Vp	RGC1A60D15KKE	RGC1A60D25KKE	RGC1A60D30KKE
600 VAC, 1600 Vp, 6600 A ² s	RGH1A60D15KKE		RGH1A60D31KKE
AC/DC control voltage			
230 VAC, 800 Vp	RGC1A23A15KKE	RGC1A23A25KKE	RGC1A23A30KKE
600 VAC, 1200 Vp	RGC1A60A15KKE	RGC1A60A25KKE	RGC1A60A30KKE
600 VAC, 1600 Vp, 6600 A ² s	RGH1A60A15KKE		RGH1A60A31KKE

Instant On (Random) Switching available on request (RGC1860D...)

Solid state contactors, 1-phase

Ready for use design - DIN rail mounting, AC output switching

Types	RGC/RGH1A..15MKE 20 AAC	RGC1A..25MKE 25 AAC	RGC/RGH1A..30MKE 30 AAC
Single phase, semiconductor contactors with integrated heatsink, LED indication and IP20 protection, AC operating frequency 45-65 Hz, rated isolation voltage ≥ 4000 Vrms, 100 kArms short circuit current rating, motor ratings according to UL508			
Dimensions HxWxD (mm)	110 x 17.8 x 114.5	110 x 17.8 x 114.5	110 x 22.5 x 152
Features	17.8 mm wide solid state contactor, integrated varistor for overvoltage protection, DC or AC control voltage range, screw terminals with captivated clamp for power terminals and spring plug for control, E-type layout	17.8 mm wide solid state contactor, integrated varistor for overvoltage protection, DC or AC control voltage range, screw terminals with captivated clamp for power terminals and spring plug for control, E-type layout	22.5 mm wide solid state contactor, integrated varistor for overvoltage protection, DC or AC control voltage range, screw terminals with captivated clamp for power terminals and spring plug for control, E-type layout

Input specifications

Control input range	3-32 VDC [RG.23D.]/4-32 VDC [RG.60D.] 20-275 VAC, 24-190 VDC [RG..A.]	3-32 VDC [RG.23D.]/4-32 VDC [RG.60D.] 20-275 VAC, 24-190 VDC [RG..A.]	3-32 VDC [RG.23D.]/4-32 VDC [RG.60D.] 20-275 VAC, 24-190 VDC [RG..A.]
Max. input current	11 mA DC [RG..D.] 30 mA AC [RG..A.]	11 mA DC [RG..D.] 30 mA AC [RG..A.]	11 mA DC [RG..D.] 30 mA AC [RG..A.]

Output specifications

Rated operational current			
AC 51 @ Ta=40°C	20 AAC	25 AAC	30 AAC
AC 53a @ Ta=40°C	5 AAC	5 AAC	8 AAC [RGC..30.] 10 AAC [RGH..31.]
Min. operational current	150 mA [RGC..15.] 400 mA [RGH..15.]	250 mA	250 mA [RGC..30.] 400 mA [RGH..31.]
Non rep. surge current (t=10 ms)	325 Ap [RGC...15..] 1150 Ap [RGH...15..]	600 Ap	600 Ap [RGC..30.] 1150 Ap [RGH..31.]
Off-state leakage current	3 mA AC	3 mA AC	3 mA AC
I ² t for fusing (t=10 ms)	525 A ² s [RGC..15.] 6600 A ² s [RGH..15.]	1800 A ² s	1800 A ² s [RGC..30.] 6600 A ² s [RGH..31.]
Critical dV/dt (@Tj init=40°C)	1000 V/ μ s	1000 V/ μ s	1000 V/ μ s

General specifications

Operational voltage range	24-240 VAC +10% [RG.23..] 42-600 VAC +10% [RG.60..]	24-240 VAC +10% [RG.23..] 42-600 VAC +10% [RG.60..]	24-240 VAC +10% [RG.23..] 42-600 VAC +10% [RG.60..]
Blocking voltage	800 Vp [RGC.23.] 1200 Vp [RGC.60.] 1600 Vp [RGH.60.]	800 Vp [RGC.23.] 1200 Vp [RGC.60.]	800 Vp [RGC.23.] 1200 Vp [RGC.60.] 1600 Vp [RGH.60.]
Power factor	≥ 0.5 at rated voltage	≥ 0.5 at rated voltage	≥ 0.5 at rated voltage
Operating temperature	-40°C to +80°C	-40°C to +80°C	-40°C to +80°C
Approvals/Marks	CE - cULus - VDE - GL [RGC..15.]	CE - cULus - VDE - GL	CE - cULus - VDE - GL [RGC..30.]



References

DC control voltage			
230 VAC, 800 Vp	RGC1A23D15MKE	RGC1A23D25MKE	RGC1A23D30MKE
600 VAC, 1200 Vp	RGC1A60D15MKE	RGC1A60D25MKE	RGC1A60D30MKE
600 VAC, 1600 Vp, 6600 A ² s	RGH1A60D15MKE		RGH1A60D31MKE
AC/DC control voltage			
230 VAC, 800 Vp	RGC1A23A15MKE	RGC1A23A25MKE	RGC1A23A30MKE
600 VAC, 1200 Vp	RGC1A60A15MKE	RGC1A60A25MKE	RGC1A60A30MKE
600 VAC, 1600 Vp, 6600 A ² s	RGH1A60A15MKE		RGH1A60A31MKE

Instant On (Random) Switching available on request (RGC1B60D...)

Solid state contactors, 1-phase

Ready for use design - DIN rail mounting, AC output switching

Types	RGC1A..15KGU 20 AAC	RGC1A..25KGU 25 AAC	RGC1A..30KGU 30 AAC
Single phase, semiconductor contactors with integrated heatsink, LED indication and IP20 protection, AC operating frequency 45-65 Hz, rated isolation voltage ≥ 4000 Vrms, 100 kArms short circuit current rating, motor ratings according to UL508			
Dimensions HxWxD (mm)	110 x 17.8 x 103.5	110 x 17.8 x 103.5	110 x 22.5 x 141
Features	17.8 mm wide solid state contactor, integrated varistor for overvoltage protection, DC or AC control voltage range, screw terminals with captivated clamp for connection of control terminals and box clamps for power terminals, U-type layout	17.8 mm wide solid state contactor, integrated varistor for overvoltage protection, DC or AC control voltage range, screw terminals with captivated clamp for connection of control terminals and box clamps for power terminals, U-type layout	22.5 mm wide solid state contactor, integrated varistor for overvoltage protection, DC or AC control voltage range, screw terminals with captivated clamp for connection of control terminals and box clamps for power terminals, U-type layout

Input specifications

Control input range	3-32 VDC [RG.23D.] 4-32 VDC [RG.60D.] 20-275 VAC, 24-190 VDC [RG..A.]	3-32 VDC [RG.23D.] 4-32 VDC [RG.60D.] 20-275 VAC, 24-190 VDC [RG..A.]	3-32 VDC [RG.23D.] 4-32 VDC [RG.60D.] 20-275 VAC, 24-190 VDC [RG..A.]
Max. input current	11 mADC [RG..D.] 30 mAAC [RG..A.]	11 mADC [RG..D.] 30 mAAC [RG..A.]	11 mADC [RG..D.] 30 mAAC [RG..A.]

Output specifications

Rated operational current			
AC 51 @ Ta=40°C	20 AAC	25 AAC	30 AAC
AC 53a @ Ta=40°C	5 AAC	5 AAC	8 AAC
Min. operational current	150 mA	250 mA	250 mA
Non rep. surge current (t=10 ms)	325 Ap	600 Ap	600 Ap
Off-state leakage current	3 mAAC	3 mAAC	3 mAAC
I ² t for fusing (t=10 ms)	525 A ² s	1800 A ² s	1800 A ² s
Critical dV/dt (@ Tj init = 40°C)	1000 V/ μ s	1000 V/ μ s	1000 V/ μ s

General specifications

Operational voltage range	24-240 VAC +10% [RG.23..] 42-600 VAC +10% [RG.60..]	24-240 VAC +10% [RG.23..] 42-600 VAC +10% [RG.60..]	24-240 VAC +10% [RG.23..] 42-600 VAC +10% [RG.60..]
Blocking voltage	800 Vp [RGC.23.] 1200 Vp [RGC.60.]	800 Vp [RGC.23.] 1200 Vp [RGC.60.]	800 Vp [RGC.23.] 1200 Vp [RGC.60.]
Power factor	≥ 0.5 at rated voltage	≥ 0.5 at rated voltage	≥ 0.5 at rated voltage
Operating temperature	-40°C to +80°C	-40°C to +80°C	-40°C to +80°C
Approvals/Marks	CE - cULus - VDE - GL	CE - cULus - VDE - GL	CE - cULus - VDE - GL

References

DC control voltage			
230 VAC, 800 Vp	RGC1A23D15KGU	RGC1A23D25KGU	RGC1A23D30KGU
600 VAC, 1200 Vp	RGC1A60D15KGU	RGC1A60D25KGU	RGC1A60D30KGU
AC/DC control voltage			
230 VAC, 800 Vp	RGC1A23A15KGU	RGC1A23A25KGU	RGC1A23A30KGU
600 VAC, 1200 Vp	RGC1A60A15KGU	RGC1A60A20KGU	RGC1A60A30KGU

Instant On (Random) Switching available on request (RGC1B60D...)

Solid state contactors, 1-phase

Ready for use design - DIN rail mounting, AC output switching

Types	RG..40/41/42KGE 40/43 AAC	RG..40/41/42MGE 40/43 AAC	RG..60/62KGE 60/65 AAC	RGC1A..62MGE 65 AAC
Single phase, semiconductor contactors with integrated heatsink, LED indication and IP20 protection, AC operating frequency 45-65 Hz, rated isolation voltage \geq 4000 Vrms, 100 kArms short circuit current rating, motor ratings according to UL508				

Dimensions HxWxD (mm)	110 x 35.6 x 141	110 x 35.6 x 152	110 x 69.1 x 141	110 x 69.1 x 152
Features	35 mm wide solid state contactor, integrated varistor, DC or AC control voltage, screw terminals for control, box clamp for power terminals, E-type layout	35 mm wide solid state contactor, integrated varistor, DC or AC control voltage, spring plug for control, box clamp for power terminals, E-type layout	70 mm wide solid state contactor, integrated varistor, DC or AC control voltage, screw terminals for control, box clamp for power terminals, E-type layout	70 mm wide solid state contactor, integrated varistor, DC or AC control voltage, spring plug for control, box clamp for power terminals, E-type layout

Input specifications

Control input range	3-32 VDC [RG..23D..] 4-32 VDC [RG..60D..] 20-275 VAC, 24-190 VDC [RG..A..]	3-32 VDC [RG..23D..] 4-32 VDC [RG..60D..] 20-275 VAC, 24-190 VDC [RG..A..]	60 / 65 AAC [RGC..60/62], 60 AAC [RGH..60]	3-32 VDC [RG..23D..] 4-32 VDC [RG..60D..] 20-275 VAC, 24-190 VDC [RG..A..]
Max. input current	11 mADC [RG..D..] 30 mAAC [RG..A..]	11 mADC [RG..D..] 30 mAAC [RG..A..]	11 mADC [RG..D..] 30 mAAC [RG..A..]	11 mADC [RG..D..] 30 mAAC [RG..A..]

Output specifications

Rated operational current AC 51 @ Ta=40°C	40 / 43 AAC [RGC..40/42], 40 AAC [RGH..40/41]	40 / 43 AAC [RGC..40/42], 40 AAC [RGH..41]	60 / 65 AAC [RGC..60/62], 60 AAC [RGH..60]	65 AAC [RGC..62]
AC 53a @ Ta=40°C	13 / 16 AAC [RGC..40/42], 10 / 13 AAC [RGH..40/41]	13 / 16 AAC [RGC..40/42], 13 AAC [RGH..41]	14.8 / 20 AAC [RGC..60/62], 18 AAC [RGH..60]	20 AAC [RGC..62]
Min. operational current	400 / 500 mAAC [RGC..40/42], 250 / 400 mAAC [RGH..40/41]	400 / 500 mAAC [RGC..40/42], 400 mAAC [RGH..41]	400 / 500 mAAC [RGC..60/62], 400 mAAC [RGH..60]	500 mAAC [RGC..62]
Non rep. surge current (t=10 ms)	800 / 1900 Ap [RGC..40/42], 600 / 1150 Ap [RGH..40/41]	800 / 1900 Ap [RGC..40/42], 1150 Ap [RGH..41]	800 / 1900 Ap [RGC..60/62], 1150 Ap [RGH..60]	1900 Ap [RGC..62]
Off-state leakage current	3 mAAC	3 mAAC	3 mAAC	3 mAAC
I ² t for fusing (t=10 ms)	3200 / 18000 A ² s [RGC..40/42], 1800 / 6600 A ² s [RGH..40/41]	3200 / 18000 A ² s [RGC..40/42], 6600 A ² s [RGH..41]	3200 / 18000 A ² s [RGC..60/62], 6600 A ² s [RGH..60]	18000 A ² s [RGC..62]
Critical dV/dt (@Tj init=40°C)	1000 V/μs	1000 V/μs	1000 V/μs	1000 V/μs

General specifications

Operational voltage range	24-240 VAC +10% [RG..23..] 42-600 VAC +10% [RG..60..] 42-690 VAC +10% [RG..69..]*	24-240 VAC +10% [RG..23..] 42-600 VAC +10% [RG..60..]	24-240 VAC +10% [RG..23..] 42-600 VAC +10% [RG..60..] 42-690 VAC +10% [RG..69..]*	24-240 VAC +10% [RG..23..] 42-600 VAC +10% [RG..60..]
Blocking voltage	800 Vp [RGC..23..] 1200 Vp [RGC..60..] 1600 Vp [RGH..60/69..]	800 Vp [RGC..23..] 1200 Vp [RGC..60..] 1600 Vp [RGH..60..]	800 Vp [RGC..23..] 1200 Vp [RGC..60..] 1600 Vp [RGH..60/69..]	800 Vp [RGC..23..] 1200 Vp [RGC..60..]
Power factor	\geq 0.5 at rated voltage	\geq 0.5 at rated voltage	\geq 0.5 at rated voltage	\geq 0.5 at rated voltage
Operating temperature	-40°C to +80°C	-40°C to +80°C	-40°C to +80°C	-40°C to +80°C
Approvals/Marks	CE - cULus - VDE	CE - cULus - VDE	CE - cULus - VDE	CE - cULus - VDE

References

230 VAC, 800 Vp, 3200 A ² s	40 AAC: RGC1A23X40KGE	40 AAC: RGC1A23X40MGE	60 AAC: RGC1A23X60KGE	
230 VAC, 800 Vp, 18000 A ² s	43 AAC: RGC1A23X42KGE	43 AAC: RGC1A23X42MGE	65 AAC: RGC1A23X62KGE	65 AAC: RGC1A23X62MGE
600 VAC, 1200 Vp, 3200 A ² s	40 AAC: RGC1A60X40KGE	40 AAC: RGC1A60X40MGE	60 AAC: RGC1A60X60KGE	
600 VAC, 1200 Vp, 18000 A ² s	43 AAC: RGC1A60X42KGE	43 AAC: RGC1A60X42MGE	65 AAC: RGC1A60X62KGE	65 AAC: RGC1A60X62MGE
600 VAC, 1600 Vp, 1800 A ² s	40 AAC: RGH1A60X40KGE			
600 VAC, 1600 Vp, 6600 A ² s	40 AAC: RGH1A60X41KGE	40 AAC: RGH1A60X41MGE	60 AAC: RGH1A60X60KGE	
690 VAC, 1600 Vp, 6600 A ² s	40 AAC: RGH1A69X41KGE*		60 AAC: RGH1A69X60KGE*	

X must be replaced with D for DC control 3-32 VDC, 4-32 VDC (for 600 VAC versions)

X must be replaced with A for AC control 20-275 VAC, 24-190 VDC

RGC1B.. models for Instant On (Random) switching are available on request

*690VAC variants are CE marked only and do not include a varistor across the output

CARLO GAVAZZI Automation Components. Specifications are subject to change without notice. Illustrations are for example only.

Solid state contactors, 1-phase

Ready for use design - DIN rail mounting

AC output switching

DC output switching

Types

RG..40/42KGU
40/43 AAC

RG..60/62KGU
60/65 AAC

RGC1D1000D15KKE
15 ADC

Single phase, semiconductor contactors with integrated heatsink, LED indication and IP20 protection, rated isolation voltage ≥ 4000 Vrms, 100 kArms short circuit current rating and motor ratings according to UL508 for AC output switching



Dimensions HxWxD (mm)

110 x 35.6 x 141

110 x 69.1 x 141

110 x 17.8 x 141

Features

35 mm wide solid state contactor, integrated varistor, DC or AC control voltage, screw terminals for control, box clamp for power terminals, U-type layout

70 mm wide solid state contactor, integrated varistor, DC or AC control voltage, screw terminals for control, box clamp for power terminals, U-type layout

17.8 mm wide solid state contactor for DC switching with integrated free wheeling diode, DC control, screw terminals for power and control, E-type layout

Input specifications

Control input range	3-32 VDC [RG..23D..] 4-32 VDC [RG..60D..] 20-275 VAC, 24-190 VDC [RG..A..]	3-32 VDC [RG..23D..] 4-32 VDC [RG..60D..] 20-275 VAC, 24-190 VDC [RG..A..]	4.5-32 VDC
Max. input current	11 mAADC [RG..D..] 30 mAAC [RG..A..]	11 mAADC [RG..D..] 30 mAAC [RG..A..]	13.7 mAADC

Output specifications

Rated operational current			
AC-51 @ Ta = 40°C	40/43 AAC [RGC..40/42] 40 AAC [RGH..41]	60 / 65 AAC [RGC..60/62], 60 AAC [RGH..60]	
AC-53a @ Ta = 40°C	13/16 AAC [RGC..40/42] 13 AAC [RGH..41]	14.8 / 20 AAC [RGC..60/62], 18 AAC [RGH..60]	
DC I @ 60°C			8 ADC
Min. operational current	400 / 500 mAAC [RGC..40/42], 400 mAAC [RGH..41]	400 / 500 mAAC [RGC..60/62], 400 mAAC [RGH..60]	20 mAADC
Non rep. surge current (t=10 ms)	800 / 1900 Ap [RGC..40/42], 1150 Ap [RGH..41]	800 / 1900 Ap [RGC..60/62], 1150 Ap [RGH..60]	200 ADC (10us)
Off-state leakage current	3 mAAC	3 mAAC	3 mAAC
I ² t for fusing (t=10 ms)	3200 / 18000 A ² s [RGC..40/42], 6600 A ² s [RGH..41]	3200 / 18000 A ² s [RGC..60/62], 6600 A ² s [RGH..60]	1.5 mAADC
Critical dV/dt (@ Tj init= 40°C)	1000 V/μs	1000 V/μs	1000 V/μs

General specifications

Operational voltage range	24-240 VAC +10% [RG..23..] 42-600 VAC +10% [RG..60..] 42-690 VAC +10% [RG..69..]*	24-240 VAC +10% [RG..23..] 42-600 VAC +10% [RG..60..] 42-690 VAC +10% [RG..69..]*	24-1000 VDC [CE] 24-600 VDC [UL508]
Blocking voltage	800 Vp [RGC..23..] 1200 Vp [RGC..60..] 1600 Vp [RGH..60/69..]	800 Vp [RGC..23..] 1200 Vp [RGC..60..] 1600 Vp [RGH..60/69..]	1200 Vp
Power factor	≥ 0.5 at rated voltage	≥ 0.5 at rated voltage	
Operating temperature	-40°C to +80°C	-40°C to +80°C	-40°C to +80°C
Approvals/Marks	CE - cULus - VDE	CE - cULus - VDE	CE - cULus

References



230 VAC, 800 Vp, 3200 A ² s	40 AAC: RGC1A23X40KGU	60 AAC: RGC1A23X60KGU	
230 VAC, 800 Vp, 18000 A ² s	43 AAC: RGC1A23X42KGU	65 AAC: RGC1A23X62KGU	
600 VAC, 1200 Vp, 3200 A ² s	40 AAC: RGC1A60X40KGU	60 AAC: RGC1A60X60KGU	
600 VAC, 1200 Vp, 18000 A ² s	43 AAC: RGC1A60X42KGU	65 AAC: RGC1A60X62KGU	
600 VAC, 1600 Vp, 6600 A ² s	40 AAC: RGH1A60X41KGU	60 AAC: RGH1A60X60KGU	
690 VAC, 1600 Vp, 6600 A ² s	40 AAC: RGH1A69X41KGU*	60 AAC: RGH1A69X60KGU*	
1000 VDC			15 ADC: RGC1D1000D15KKE

X must be replaced with D for DC control 3-32 VDC, 4-32 VDC (for 600 VAC versions). X must be replaced with A for AC control 20-275 VAC, 24-190 VDC
RGC1B.. models for Instant On (Random) switching are available on request

*690 VAC variants are CE marked only and do not include a varistor across the output

Solid state contactors, 1-phase

Ready for use design - DIN rail mounting
AC output switching with integrated over temperature protection

Types	RGC1A..25GKEP 25 AAC	RGC1A..30GKEP 30 AAC	RGC1A..40/42GG.P 40/43 AAC
Single phase, semiconductor contactors with integrated heatsink, LED indication and IP 20 protection, AC operating frequency 45-65 Hz, rated isolation voltage ≥ 4000 Vrms, 100 kArms short circuit current rating, motor ratings according to UL508			
Dimensions HxWxD (mm)	110 x 22.5 x 130	110 x 22.5 x 168	110x 35.6 x 168
Features	22.5 mm wide solid state contactor, integrated varistor for overvoltage protection and integrated over temperature for protection against over heating, screw terminals with captivated clamp for connection of power terminals and box clamps for control terminals	22.5 mm wide solid state contactor, integrated varistor for overvoltage protection and integrated over temperature for protection against over heating, screw terminals with captivated clamp for connection of power terminals and box clamps for control terminals	35 mm wide solid state contactor, integrated varistor for overvoltage protection and integrated over temperature for protection against over heating, box clamps for connection of power and control terminals

Input specifications

Control input range	5-32 VDC [RG.D.] 20-275 VAC, 24-190 VDC [RG..A.]	5-32 VDC [RG.D.] 20-275 VAC, 24-190 VDC [RG..A.]	5-32 VDC [RG.D.] 20-275 VAC, 24-190 VDC [RG..A.]
Max. input current	24 mADC [RG..D.] 35 mAAC [RG..A.]	24 mADC [RG..D.] 35 mAAC [RG..A.]	24 mADC [RG..D.] 35 mAAC [RG..A.]

Supply voltage

Rated supply voltage	24 VDC -15%, +20%	24 VDC -15%, +20%	24 VDC -15%, +20%
Max. current rating	50 mADC	50 mADC	50 mADC

Over temperature alarm

Alarm output	PNP open collector normally closed, max. 24 VDC / 50 mA [RG.C.D.P] Potential free normally closed, max. 24 VDC / 50 mA [RG.C.A.P]	PNP open collector normally closed, max. 24 VDC / 50 mA [RG.C.D.P] Potential free normally closed, max. 24 VDC / 50 mA [RG.C.A.P]	PNP open collector normally closed, max. 24 VDC / 50 mA [RG.C.D.P] Potential free normally closed, max. 24 VDC / 50 mA [RG.C.A.P]
--------------	--	--	--

Output specifications

Rated operational current			
AC 51 @ Ta=40°C	25 AAC	30 AAC	40 AAC [RGC..40], 43 AAC [RGC..42]
AC 53a @ Ta=40°C	5 AAC	8 AAC	13 AAC [RGC..40], 16 AAC [RGC..42]
Min. operational current	250 mA	250 mA	400 mAAC [RGC..40], 500 mAAC [RGC..42]
Non rep. surge current (t=10 ms)	600 Ap	600 Ap	800 Ap [RGC..40] 1900 Ap [RGC..42]
Off-state leakage current	3 mAAC	3 mAAC	3 mAAC
I ² t for fusing (t=10 ms)	1800 A ² s	1800 A ² s	3200 A ² s [RGC..40], 18000 A ² s [RGC..42]
Critical dV/dt off-state (@ Tj init = 40°C)	1000 V/μs	1000 V/μs	1000 V/μs

General specifications

Operational voltage range	24-240 VAC +10% [RG.23..] 42-600 VAC +10% [RG.60..]	24-240 VAC +10% [RG.23..] 42-600 VAC +10% [RG.60..]	24-240 VAC +10% [RG.23..] 42-600 VAC +10% [RG.60..]
Blocking voltage	800 Vp [RGC.23.] 1200 Vp [RGC.60.]	800 Vp [RGC.23.] 1200 Vp [RGC.60.]	1200 Vp
Power factor	≥ 0.5 at rated voltage	≥ 0.5 at rated voltage	≥ 0.5 at rated voltage
Operating temperature	-40°C to +70°C	-40°C to +70°C	-40°C to +70°C
Approvals/Marks	CE - cULus - VDE	CE - cULus - VDE	CE - cULus - VDE

References

DC control voltage			
230 VAC, 800 Vp		30 AAC: RGC1A23D30GKEP	
600 VAC, 1200 Vp	25 AAC: RGC1A60D25GKEP	30 AAC: RGC1A60D30GKEP	40 AAC: RGC1A60D40GGXP
600 VAC, 1200 Vp, high I ² t			43 AAC: RGC1A60D42GGXP
AC/DC control voltage			
600 VAC, 1200 Vp	25 AAC: RGC1A60A25GKEP	30 AAC: RGC1A60A30GKEP	40 AAC: RGC1A60A40GGXP
600 VAC, 1200 Vp, high I ² t			43 AAC: RGC1A60A42GGXP

X must be replaced with the following depending on the connection configuration required
Configuration X: E = E-type U = U-type

CARLO GAVAZZI Automation Components. Specifications are subject to change without notice. Illustrations are for example only.

Solid state contactors, 1-phase

Ready for use design - DIN rail mounting, AC output switching

Integrated over temperature protection

Integrated fuse

Types

RGC1A..60/62GG.P
60/65 AAC

RGC1A..90/92GG.P
85 AAC

RGC1F
20/30/40 AAC

Single phase, semiconductor contactors with integrated heatsink, LED indication and IP20 protection, AC operating frequency 45-65 Hz, rated isolation voltage ≥ 4000 Vrms, 100 kArms short circuit current rating, motor ratings according to UL508



Dimensions HxWxD (mm)

110 x 69.1 x 168

126 x 69.1 x 168 (with fan)

110 x 35.6 x 168

Features

70 mm wide solid state contactor, integrated varistor for overvoltage protection and integrated over temperature for protection against over heating, box clamps for connection of power & control terminals

70 mm wide solid state contactor with attached fan, integrated varistor for overvoltage protection and integrated over temperature for protection against over heating, box clamps for connection of power & control terminals

35 mm wide solid state contactor with integrated fuse, additional monitoring features available with RGC1FS.. for SSR, load & fuse failure detection, integrated varistor for overvoltage protection, DC control voltage range, box clamps for connection of power & control terminals

Input specifications

Control input range	5-32 VDC [RG.D.] 20-275 VAC, 24-190 VDC [RG..A.]	5-32 VDC [RG.D.] 20-275 VAC, 24-190 VDC [RG..A.]	3-32 VDC [RGC1F..23.] 4.5-32 VDC [RGC1F..60.]
Max. input current	23 mADC [RG..D.]/35 mAAC [RG..A.]	23 mADC [RG..D.]/35 mAAC [RG..A.]	12 mA

Supply voltage

Rated supply voltage	24 VDC -15%, +20%	24 VDC -15%, +20%	24 VDC -15%, +20%
Max. current rating	50 mADC	50 mADC (fan rating 24 VDC / 50 mA)	80 mADC

Over temperature alarm

Alarm output	PNP open collector normally closed, max. 24 VDC / 50 mA [RGC.D.P] Potential free normally closed, max. 24 VDC / 50 mA [RGC.A.P]	PNP open collector normally closed, max. 24 VDC / 50 mA [RGC.D.P] Potential free normally closed, max. 24 VDC / 50 mA [RGC.A.P]	PNP open collector normally closed, max. 24 VDC / 50 mA [RGC1F..S.]
--------------	--	--	---

Output specifications

Rated operational current			
AC 51 @ Ta=40°C	60 AAC [RGC..60] 65 AAC [RGC..62]	85 AAC	20 AAC [RGC1F..20.]/30 AAC [RGC1F..30.]/40 AAC [RGC1F..40.]
AC 53a @ Ta=40°C	14.8 AAC [RGC..60] 20 AAC [RGC..62]	18 AAC [RGC..90] 20 AAC [RGC..92]	4.7 AAC [RGC1F..20.]/6 AAC [RGC1F..30.]/8 AAC [RGC1F..40.]
Min. operational current	400 mA [RGC..60] 500 mA [RGC..62]	400 mA [RGC..90] 500 mA [RGC..92]	200 mA
Non rep. surge current (I _{tsm}) (t=10 ms)	800 A _p [RGC..60] 1900 A _p [RGC..62]	1150 A _p [RGC..90] 1900 A _p [RGC..92]	Integrated fuse
Off-state leakage current	3 mAAC	3 mAAC	
I ² t for fusing (t=10 ms)	3200 A ² s [RGC..60] 18000 A ² s [RGC..62]	6600 A ² s [RGC..90] 18000 A ² s [RGC..92]	Fuse - 740A ² s [RGC1F..20..] Fuse - 1400A ² s [RGC1F..30..] Fuse - 3100A ² s [RGC1F..40..]
Critical dV/dt off-state (@ T _j init = 40°C)	1000 V/μs	1000 V/μs	1000 V/μs

General specifications

Operational voltage range	42-600 VAC +10% [RG.60...]	24-240 VAC +10% [RG.23..] 42-600 VAC +10% [RG.60..]	24-240 VAC +10% [RG.23..] 42-600 VAC +10% [RG.60..]
Blocking voltage	1200 V _p	800 V _p [RGC.23.]/1200 V _p [RGC.60.]	1200 V _p
Power factor	≥ 0.5 at rated voltage	≥ 0.5 at rated voltage	≥ 0.5 at rated voltage
Operating temperature	-40°C to +70°C	-40°C to +70°C	-40°C to +70°C
Approvals/Marks	CE - cULus - VDE	CE - cULus - VDE	CE - cULus (up to 30 AAC)

References



DC control voltage			
230 VAC, 800 V _p		85 AAC: RGC1A23D90GGXP	20 AAC: RGC1FY23D20GGE 30 AAC: RGC1FY23D30GGE 40 AAC: RGC1FY23D40GGE
600 VAC, 1200 V _p	60 AAC: RGC1A60D60GGXP 65 AAC: RGC1A60D62GGXP	85 AAC: RGC1A60D90GGXP 85 AAC: RGC1A60D92GGXP	20 AAC: RGC1FY60D20GGE 30 AAC: RGC1FY60D30GGE 40 AAC: RGC1FY60D40GGE
AC/DC control voltage			
600 VAC, 1200 V _p	60 AAC: RGC1A60A60GGXP 65 AAC: RGC1A60A62GGXP	85 AAC: RGC1A60A90GGXP 85 AAC: RGC1A60A92GGXP	

X and Y must be replaced with the following depending on the version required
Configuration X: E = E-type U = U-type
Version Y: A = fuse only S = fuse + monitoring

CARLO GAVAZZI Automation Components. Specifications are subject to change without notice. Illustrations are for example only.

Solid state contactors, 1-phase

Ready for use design - AC output switching,
Integrated current measurement



Types	RGC1S..20/30/31GKEP 23/30 AAC	RGC1S..25GKEP 25 AAC	RGC1S..26GGEP 25 AAC
Single phase, semiconductor contactors with integrated current measurement, E-type configuration, LED indication and IP20 protection, AC operating frequency 45-65 Hz, rated isolation voltage ≥ 4000 Vrms, 100 kArms short circuit current rating			
Dimensions HxWxD (mm)	110 x 22.5 x 163	110 x 22.5 x 126	110 x 22.5 x 126
Features	22.5 mm wide solid state contactor, integrated varistor, DC control, local or remote TEACH, detection of partial load failure (1/6), SSR and load malfunction, SSR overheat protection	22.5 mm wide solid state contactor, integrated varistor, DC control, local or remote TEACH, detection of partial load failure (1/6), SSR and load malfunction, SSR overheat protection	22.5 mm wide solid state contactor, integrated varistor, DC control, local or remote TEACH, detection of partial load failure (1/6), SSR and load malfunction, SSR overheat protection
Input specifications			
Control input range	4-32 VDC	4-32 VDC	4-32 VDC
Max. input current	10 mA DC at 24 VDC	10 mA DC at 24 VDC	10 mA DC at 24 VDC
Supply voltage			
Rated supply voltage	24 VDC -15%, +20%	24 VDC -15%, +20%	24 VDC -15%, +20%
Max. current rating	50 mA DC	50 mA DC	50 mA DC
Alarm specifications			
Output type	NC PNP open collector max. 35 VDC/50 mA	NC PNP open collector max. 35 VDC/50 mA	NC PNP open collector max. 35 VDC/50 mA
Alarm Indication	Red LED (flash rate)	Red LED (flash rate)	Red LED (flash rate)
Output specifications			
Rated operational current			
AC 51 @ $T_a=40^\circ\text{C}$	23 AAC [RGC1S..20] 30 AAC [RGC1S..30] 30 AAC [RGC1S..31]	25 AAC	25 AAC
Minimum TEACH / operational current	1.2 AAC	1.2 AAC	1.2 AAC
Minimum partial load current	0.2 AAC	0.2 AAC	0.2 AAC
Detectable partial load failure	>16.67% from current setpoint	>16.67% from current setpoint	>16.67% from current setpoint
Non. rep. surge current I_{tsm} (t=10ms)	325 Ap [RGC1S..20] 600 Ap [RGC1S..30] 1150 Ap [RGC1S..31]	600 Ap	1900 Ap
Max. off state leakage current	3 mA AC	3 mA AC	3 mA AC
I^2t for fusing (t=10ms)	525 A ² s [RGC1S..20] 1800 A ² s [RGC1S..30] 6600 A ² s [RGC1S..31]	1800 A ² s	18000 A ² s
Critical dV/dt (@ T_j init = 40°C)	1000 V/ μ s	1000 V/ μ s	1000 V/ μ s
General specifications			
Operational voltage range	42-600 VAC +10%	42-600 VAC +10%	42-600 VAC +10%
Blocking voltage	1200 V _p	1200 V _p	1200 V _p
Power factor	≥ 0.9 at rated voltage	≥ 0.9 at rated voltage	≥ 0.9 at rated voltage
Operating temperature	-25°C to +70°C	-25°C to +70°C	-25°C to +70°C
Approvals/Marks	CE - cULus	CE - cULus	CE - cULus
References			
600 VAC, 1200 V _p , 525A ² s	23 AAC: RGC1S60D20GKEP		
600 VAC, 1200 V _p , 1800A ² s	30 AAC: RGC1S60D30GKEP	25 AAC: RGC1S60D25GKEP	
600 VAC, 1200 V _p , 6600A ² s	30 AAC: RGC1S60D31GKEP		
600 VAC, 1200 V _p , 18000A ² s			25 AAC: RGC1S60D26GGEP

GK = screws for control terminals, box clamps for power terminals
GG = box clamps for control terminals, box clamps for power terminals

CARLO GAVAZZI Automation Components. Specifications are subject to change without notice. Illustrations are for example only.

Solid state contactors, 1-phase



Ready for use design - AC output switching,
Integrated current measurement

Types	RGC1S..41GG.P 43 AAC	RGC1S..61GG.P 65 AAC	RGC1S..90GGEP 85 AAC
Single phase, semiconductor contactors with integrated heatsink, LED indication and IP20 protection, AC operating frequency 45-65 Hz, Rated isolation voltage ≥ 4000 Vrms, 100 kArms short circuit current rating, motor ratings according to UL508			
Dimensions HxWxD (mm)	110 x 35.6 x 163	110 x 69.1 x 163	126 x 69.1 x 163 (with fan)
Features	35 mm wide solid-state contactor, integrated varistor, DC control, local or remote TEACH, detection of partial load failure (1/6), SSR and load malfunction, SSR overheat protection	70 mm wide solid-state contactor, integrated varistor, DC control, local or remote TEACH, detection of partial load failure (1/6), SSR and load malfunction, SSR overheat protection	70 mm wide solid-state contactor with integrated varistor, DC control, local or remote TEACH, detection of partial load failure (1/6), SSR and load malfunction, SSR overheat protection
Input specifications			
Control input range	4-32 VDC	4-32 VDC	4-32 VDC
Max. input current	10 mADC at 24 VDC	10 mADC at 24 VDC	10 mADC at 24 VDC
Supply voltage			
Supply Voltage	24 VDC -15%, +20%	24 VDC -15%, +20%	24 VDC -15%, +20%
Max. current rating	50 mADC	50 mADC	50 mADC (fan rating 24 VDC / 50 mA)
Alarm specifications			
Output type	NC PNP open collector max. 35 VDC / 50 mA	NC PNP open collector max. 35 VDC / 50 mA	NC PNP open collector max. 35 VDC / 50 mA
Alarm Indication	Red LED (flash rate)	Red LED (flash rate)	Red LED (flash rate)
Output specifications			
Rated operational current			
AC 51 @ Ta=40°C	43 AAC	65 AAC	85 AAC
Minimum TEACH / operational current	1.2 AAC	5 AAC	5 AAC
Minimum partial load current	0.2 AAC	0.83 AAC	0.83 AAC
Detectable partial load failure	>16.67% from current setpoint	>16.67% from current setpoint	>16.67% from current setpoint
Non. rep. surge current I _{sm} (t=10ms)	1900 A _p	1900 A _p	1900 A _p
Max. off state leakage current	3 mAAC	3 mAAC	3 mAAC
I ² t for fusing (t=10 ms)	18000 A ² s	18000 A ² s	18000 A ² s
Critical dV/dt (@ T _j init = 40°C)	1000 V/μs	1000 V/μs	1000 V/μs
General specifications			
Operational voltage range	42-600 VAC +10%	42-600 VAC +10%	42-600 VAC +10%
Blocking voltage	1200 V _p	1200 V _p	1200 V _p
Power factor	≥ 0.9 at rated voltage	≥ 0.9 at rated voltage	≥ 0.9 at rated voltage
Operating temperature	-25°C to +70°C	-25°C to +70°C	-25°C to +70°C
Approvals/Marks	CE - cULus	CE - cULus	CE - cULus
References			
600 VAC, 1200 V _p , E-type	43 AAC: RGC1S60D41GGEP	65 AAC: RGC1S60D61GGEP	85 AAC: RGC1S60D90GGEP
600 VAC, 1200 V _p , U-type	43 AAC: RGC1S60D41GGUP	65 AAC: RGC1S60D61GGUP	

GG = box clamps for control terminals, box clamps for power terminals





Solid state contactors, 1-phase

Ready for use design - DIN rail mounting
Soft start switching

Types	RGC1P..K.. 30 AAC	RGC1P..K.. 43 AAC	RGC1P..K.. 63 AAC
Single phase, solid state relay with integrated heatsink, with integrated overvoltage protection, LED for control and load status indication, IP20 protection, Rated isolation voltage ≥ 4000 Vrms, 100 kArms short circuit current rating			
Dimensions HxWxD (mm)	110 x 35.8 x 104	110 x 35.8 x 104	110 x 72 x 126
Features	DC control input solid state contactor with soft starting feature for short wave infrared heaters	DC control input solid state contactor with soft starting feature for short wave infrared heaters	DC control input solid state contactor with soft starting feature for short wave infrared heaters
Supply specifications			
Supply voltage	24 VDC -15%, +20% 24 VAC -15%, +15%	24 VDC -15%, +20% 24 VAC -15%, +15%	24 VDC -15%, +20% 24 VAC -15%, +15%
Max. supply current	30 mA	30 mA	30 mA
Control specifications			
Control input	19.2 - 28.8 VDC	19.2 - 28.8 VDC	19.2 - 28.8 VDC
Input impedance	100 k Ω	100 k Ω	100 k Ω
Output specifications			
Rated operational current AC-51 @ 40°C	30 AAC	43 AAC	63 AAC
Minimum operational current	250 mAAC	500 mAAC	500 mAAC
Non rep. surge current (I _{tsm}) (t=10 ms)	600 Ap	1900 Ap	1900 Ap
I ² t for fusing (t=10 ms)	1800 A ² s	18000 A ² s	18000 A ² s
Max. Off-state leakage current	5 mAAC	5 mAAC	5 mAAC
Critical dV/dt (@ T _j init = 40°C)	1000 V/ μ s	1000 V/ μ s	1000 V/ μ s
General specifications			
Operational voltage range	85 - 265 VAC (RGC1P23..) 190 - 550 VAC (RGC1P48..) 410 - 660 VAC (RGC1P60..)	85 - 265 VAC (RGC1P23..) 190 - 550 VAC (RGC1P48..) 410 - 660 VAC (RGC1P60..)	85 - 265 VAC (RGC1P23..) 190 - 550 VAC (RGC1P48..) 410 - 660 VAC (RGC1P60..)
Blocking voltage	800 V _P (RGC1P23..) 1200 V _P (RGC1P48..) 1200 V _P (RGC1P60..)	800 V _P (RGC1P23..) 1200 V _P (RGC1P48..) 1200 V _P (RGC1P60..)	800 V _P (RGC1P23..) 1200 V _P (RGC1P48..) 1200 V _P (RGC1P60..)
Power factor	> 0.7	> 0.7	> 0.7
Terminals	Screw with captive clamp	Box clamp	Box clamp
Operating temperature	-40°C to +70°C	-40°C to +70°C	-40°C to +70°C
Approvals/Marks	CE - UL - cUL	CE - UL - cUL	CE - UL - cUL
References			
External supply 24 VDC/AC			
Operational output 85 - 265 VAC	RGC1P23K30ED	RGC1P23K42ED	RGC1P23K62ED
Operational output 190 - 550 VAC	RGC1P48K30ED	RGC1P48K42ED	RGC1P48K62ED
Operational output 410 - 660 VAC	RGC1P60K30ED	RGC1P60K42ED	RGC1P60K62ED



Solid state contactors, 1-phase

Ready for use design - DIN rail mounting
Proportional switching controllers



Types	RGC1P..AA.. / V.. 12 AAC	RGC1P..AA.. / V.. 30 AAC	RGC1P..AA.. / V.. 43 AAC	RGC1P..AA.. / V.. 50 / 63 AAC
Single phase, solid state relay with integrated heatsink, with integrated overvoltage protection, LED for control and load status indication, IP20 protection, rated isolation voltage ≥ 4000 Vrms, 100 kArms short circuit current rating				
Dimensions HxWxD (mm)	106 x 35.8 x 65	110 x 35.8 x 104	110 x 35.8 x 104	110 x 72 x 126
Features	Analog input (current or voltage), selectable modes for output switching - phase angle, full cycle distributed firing, advanced full cycle and soft starting	Analog input (current or voltage), selectable modes for output switching - phase angle, full cycle distributed firing, advanced full cycle and soft starting	Analog input (current or voltage), selectable modes for output switching - phase angle, full cycle distributed firing, advanced full cycle and soft starting	Analog input (current or voltage), selectable modes for output switching - phase angle, full cycle distributed firing, advanced full cycle and soft starting
Supply specifications				
Supply voltage	24 VDC -15%, +20% (RG..V..ED) 24 VAC -15%, +15% (RG..V..ED) 90-250 VAC (RG..V..EA)	24 VDC -15%, +20% (RG..V..ED) 24 VAC -15%, +15% (RG..V..ED) 90-250 VAC (RG..V..EA)	24 VDC -15%, +20% (RG..V..ED) 24 VAC -15%, +15% (RG..V..ED) 90-250 VAC (RG..V..EA)	24 VDC -15%, +20% (RG..V..ED) 24 VAC -15%, +15% (RG..V..ED) 90-250 VAC (RG..V..EA)
Max. supply current	30 mA (RG..V..ED) 14 mA (RG..V..EA)	30 mA (RG..V..ED) 14 mA (RG..V..EA)	30 mA (RG..V..ED) 14 mA (RG..V..EA)	30 mA (RG..V..ED) 14 mA (RG..V..EA)
Control specifications				
Control input range	4-20 mA (RG..AA..) 0-10 V, 0-5 V, 1-5 V, POT (RG..V..)	4-20 mA (RG..AA..) 0-10 V, 0-5 V, 1-5 V, POT (RG..V..)	4-20 mA (RG..AA..) 0-10 V, 0-5 V, 1-5 V, POT (RG..V..)	4-20 mA (RG..AA..) 0-10 V, 0-5 V, 1-5 V, POT (RG..V..)
Input impedance	500 Ω (RG..AA..) 100 k Ω (RG..V..)	500 Ω (RG..AA..) 100 k Ω (RG..V..)	500 Ω (RG..AA..) 100 k Ω (RG..V..)	500 Ω (RG..AA..) 100 k Ω (RG..V..)
Output specifications				
Rated operational current AC-51 @ 40°C	15 AAC	30 AAC	43 AAC	50 AAC (RG..50) 63 AAC (RG..62)
Minimum operational current	250 mAAC	250 mAAC	500 mAAC	500 mAAC
Non rep. surge current (I _{tsm}) (t=10 ms)	600 Ap	600 Ap	1900 Ap	800 Ap (RG..50) 1900 Ap (RG..62)
I ² t for fusing (t=10 ms)	1800 A ² s	1800 A ² s	18000 A ² s	3200 A ² s (RG..50) 18000 A ² s (RG..62)
Max. Off-state leakage current	5 mAAC	5 mAAC	5 mAAC	5 mAAC
Critical dV/dt (@ T _j init = 40°C)	1000 V/ μ s	1000 V/ μ s	1000 V/ μ s	1000 V/ μ s
General specifications				
Operational voltage range	85 - 265 VAC (RGC1P23..) 190 - 550 VAC (RGC1P48..)	85 - 265 VAC (RGC1P23..) 190 - 550 VAC (RGC1P48..) 410 - 660 VAC (RGC1P60..)	85 - 265 VAC (RGC1P23..) 190 - 550 VAC (RGC1P48..) 410 - 660 VAC (RGC1P60..)	85 - 265 VAC (RGC1P23..) 190 - 550 VAC (RGC1P48..) 410 - 660 VAC (RGC1P60..)
Blocking voltage	800 V _p (RGC1P23..) 1200 V _p (RGC1P48..)	800 V _p (RGC1P23..) 1200 V _p (RGC1P48..) 1200 V _p (RGC1P60..)	800 V _p (RGC1P23..) 1200 V _p (RGC1P48..) 1200 V _p (RGC1P60..)	800 V _p (RGC1P23..) 1200 V _p (RGC1P48..) 1200 V _p (RGC1P60..)
Power factor	> 0.7	> 0.7	> 0.7	> 0.7
Terminals	Screw with captive clamp	Screw with captive clamp	Box clamp	Box clamp
Operating temperature	-40°C to +70°C	-40°C to +70°C	-40°C to +70°C	-40°C to +70°C
Approvals/Marks	CE - UL - cUL	CE - UL - cUL	CE - UL - cUL	CE - UL - cUL
References				
Control input				
4-20 mA	RGC1PyyAA12E	RGC1PxxAA30E	RGC1PxxAA42E	50 AAC: RGC1PyyAA50E 63 AAC: RGC1PxxAA62E
0-10 VDC, 0-5 VDC, 1-5 VDC, POT				
External supply 24 VDC/AC	RGC1PyyV12ED	RGC1PxxV30ED	RGC1PxxV42ED	50 AAC: RGC1PyyV50ED 63 AAC: RGC1PxxV62ED
External supply 90-250 VAC	RGC1PyyV12EA	RGC1PxxV30EA	RGC1PxxV42EA	63 AAC: RGC1PxxV62EA

xx = 23 for operational voltage range 85 - 265 VAC
48 for operational voltage range 190 - 550 VAC
60 for operational voltage range 410 - 660 VAC
yy = 23 for operational voltage range 85 - 265 VAC
48 for operational voltage range 190 - 550 VAC

Solid state contactors, 1-phase





	AC output switching - MODBUS RTU	AC output switching - System monitoring
Types	RJ1P MB 50 AAC	RN1S Sense 30/50 AAC
Semiconductor contactors with integrated heatsink. AC operating frequency range 45-65 Hz. Rated isolation voltage ≥ 4000 Vrms		
Dimensions HxWxD (mm)	103 x 45 x 122	120 x 45 x 110 (30 A) 120 x 90 x 110 (50 A)
Features	SSR with fieldbus communication interface	High precision economy switching
Control specifications		
Control input range	2-wire Modbus RTU	7-32 VDC
Max. input current		4 mA
Control supply		20-32 VDC (≤ 40 mA)
Alarm output		PNP : VCC - 2 VDC (≤ 100 mA) / NPN: 2 VDC @ (≤ 100 mA)
Output specifications		
Rated operational current		
AC 51 @ $T_a=25^\circ\text{C}$	50 AACrms	30 Arms [RN1S...30..] 50 Arms [RN1S...50..]
AC 51 @ $T_a=40^\circ\text{C}$	40 AACrms	30 Arms [RN1S...30..] 50 Arms [RN1S...50..]
AC 53a @ $T_a=25^\circ\text{C}$		6 Arms [RN1S...30..] 12 Arms [RN1S...50..]
Min. operational current	500 mAACrms	200 mArms
Non-repet. surge current (t=10 ms)	1900 A _p	325 A _p [RN1S...30..] 600 A _p [RN1S...50..]
Off-state leakage current	< 3 mArms	< 6 mAAC
I ² t for fusing (t=10 ms)	18000 A ² s	525 A ² s [RN1S...30..] 1800 A ² s [RN1S...50..]
On state voltage drop	1.6 Vrms	
Critical dV/dt off-state	1000 V/ μ s	500 V/ μ s
General specifications		
Operational voltage range	90-265 VAC [RJ1P23..] 200-500 VAC [RJ1P48..] 410-660 VAC [RJ1P60..]	120-265 VAC [RN1S23..] 150-440 VAC [RN1S40..] 180-530 VAC [RN1S48..]
Blocking voltage	650V _P [RJ1P23..] 1200 V _P [RJ1P48..] 1200V _P [RJ1P60..]	800 V _P [RN1S23..] 1000 V _P [RN1S40..] 1200 V _P [RN1S48..]
Power factor	≥ 0.9	≥ 0.5
Operating temperature	-30°C - +70°C	-20°C - +70°C
Terminals	Box clamp	Box clamp
Approvals/Marks	CE - UR - cUR	CE - UR - CSA
References		
230 VAC	RJ1P23MBT50EBC	30 AAC: RN1S23H30NO
	RJ1P23MBT50ECS	30 AAC: RN1S23H30PO
	RJ1P23MBT50ECV	50 AAC: RN1S23H50NO 50 AAC: RN1S23H50PO
400 VAC		30 AAC: RN1S40H30NO
		30 AAC: RN1S40H30PO
		50 AAC: RN1S40H50NO 50 AAC: RN1S40H50PO
480 VAC	RJ1P48MBT50EBC	30 AAC: RN1S48H30NO
	RJ1P48MBT50ECS	30 AAC: RN1S48H30PO
	RJ1P48MBT50ECV	50 AAC: RN1S48H50NO 50 AAC: RN1S48H50PO
600 VAC	RJ1P60MBT50EBC	
	RJ1P60MBT50ECS	
	RJ1P60MBT50ECV	

Solid state contactors, 45mm, 3-phase

	DIN rail mounting - AC output switching, 2 + 1 poles	DIN rail mounting - AC output switching, 3 poles
Types	RGCM2A..20.. 20 AAC	RGCM3A..15.. 15 AAC
Semiconductor contactors with integrated heatsink. AC operating frequency range 45-65 Hz. Rated isolation voltage ≥ 4000 Vrms		
Dimensions HxWxD (mm)	105 x 45 x 105	105 x 45 x 105
Features	45 mm solid state contactor, enclosed heatsink, integrated varistors for over-voltage protection, 5 kArms SCCR, screw with clamp for power connection	45 mm solid state contactor, enclosed heatsink, integrated varistors for over-voltage protection, 5 kArms SCCR, screw with clamp for power connection
Control specifications		
Control input range	5-32 VDC [RG.C.D.] 20-275 VAC, 24-190 VDC [RG.C.A.]	5-32 VDC [RG.C.D.] 20-275 VAC, 24-190 VDC [RG.C.A.]
Input current @ max. control voltage	31.5 mA DC [RG.D.] 19 mA AC [RG.A.]	31.5 mA DC [RG.D.] 19 mA AC [RG.A.]
Output specifications		
Rated operational current AC-51 @ Ta = 40°C	20 AAC	15.5 AAC
AC-53a @ Ta = 40°C	7.6 AAC	5.8 AAC
Motor rating	3 kW @ 400 VAC 5 HP @ 600 VAC	2.2 kW @ 400 VAC 3 HP @ 600 VAC
Minimum operational current	250 mA AC	250 mA AC
Non. rep. surge current I _{tsm} (t=10ms)	600 A _p	600 A _p
I ² t for fusing (t=10ms)	1800 A ² s	1800 A ² s
Off-state leakage current	3 mA AC	3 mA AC
Critical dV/dt (@ T _j init=40°C)	1000 V/us	1000 V/us
General specifications		
Operational voltage range	42-600 VAC +10%	42-220 VAC + 10% [RG..22.] 42-600 VAC +10% [RG..60.]
Blocking voltage	1200 V _p	800 V _p [RG..22.] 1200 V _p [RG..60.]
Power factor	≥ 0.5 at rated voltage	≥ 0.5 at rated voltage
Operating temperature	-40°C to +70°C	-40°C to +70°C
Approvals/Marks	CE - cULus	CE - cULus
References		
DC control voltage		
220 VAC, 800 V _p		RGCM3A22D15GKE
600 VAC, 1200 V _p	RGCM2A60D20GKE	RGCM3A60D15GKE
AC control voltage		
220 VAC, 800 V _p		RGCM3A22A15GKE
600 VAC, 1200 V _p	RGCM2A60A20GKE	RGCM3A60A15GKE



Solid state contactors, 3-phase

DIN rail mounting - AC output switching, 2 + 1 poles

Types	RGC2A..10.. 10 AAC	RGC2A..25.. 27 AAC	RGC2A..40.. 40 AAC	RGC2A..75..F 75 AAC
Semiconductor contactors with integrated heatsink, AC operating frequency range 45-65 Hz. Rated isolation voltage 4000 Vrms				
Dimensions HxWxD (mm)	106 x 54 x 65	110 x 54 x 103	110 x 72 x 126	141 x 72 x 141 (with fan)
Features	54 mm solid state contactor, integrated varistors for over-voltage protection, 100 kArms SCCR, screw with clamp for power connection	54 mm solid state contactor, integrated varistors for over-voltage protection, 100 kArms SCCR, screw with clamp for power connection	72 mm solid state contactor, integrated varistors for over-voltage protection, 100 kArms SCCR, box clamp for power connection	72 mm solid state contactor, integrated overheat protection with EMR alarm output, 100 kArms SCCR, box clamp for power connection
Input specifications				
Control input range	5-32 VDC [RGC..D.] 20-275 VAC, 24-190 VDC [RGC..A.]	5-32 VDC [RGC..D.] 20-275 VAC, 24-190 VDC [RGC..A.]	5-32 VDC [RGC..D.] 20-275 VAC, 24-190 VDC [RGC..A.]	5-32 VDC [RG..D..DF] 5-32 VDC [RG..D..AF] 20-275 VAC [RG..A..AF]
Input current @ max. control voltage	31.5 mADC [RG..D.] 19 mAAC [RG..A.]	31.5 mADC [RG..D.] 19 mAAC [RG..A.]	31.5 mADC [RG..D.] 19 mAAC [RG..A.]	12.5 mADC [RG..D..DF] 5.5 mADC [RG..D..AF] 4.3 mAAC [RG..A..AF]
External supply voltage				24 VDC [RG..D..DF] 90-250 VAC [RG..D..AF] 90-250 VAC [RG..A..AF]
Max. supply current				150 mADC [RG..D..DF] 80 mADC [RG..D..AF] 80 mAAC [RG..A..AF]
Alarm specifications				
Alarm output				EMR: 2 A 230 VAC / 30 VDC
Alarm condition				Over Temperature
Output specifications				
Rated operational current AC-51 @ Ta = 40°C	10 AAC	27 AAC	40 AAC	75 AAC
AC-53a @ Ta = 40°C	5 AAC	11.5 AAC	16.5 AAC	28 AAC
Motor rating	1.5 kW @ 400 VAC 3 HP @ 600 VAC VAC	5.5 kW @ 400 VAC 10 HP @ 600 VAC	7.5 kW @ 400 VAC 15 HP @ 600 VAC	11 kW @ 400 VAC 25 HP @ 600 VAC
Minimum operational current	250 mAAC	250 mAAC	400 mAAC	500 mAAC
Non. rep. surge current I _{tsm} (t=10ms)	600 Ap	600 Ap	1150 Ap	1750 Ap
I ² t for fusing (t=10ms)	1800 A ² s	1800 A ² s	6600 A ² s	15000 A ² s
General specifications				
Operational voltage range	42-600 VAC +10%	42-220 VAC +10% [RG..22.] 42-600 VAC +10% [RG..60.]	42-600 VAC +10%	42-600 VAC +10%
Blocking voltage	1200 Vp	800 Vp [RG..22.] 1200 Vp [RG..60.]	1200 Vp	1200 Vp
Power factor	≥ 0.5 at rated voltage	≥ 0.5 at rated voltage	≥ 0.5 at rated voltage	≥ 0.5 at rated voltage
Operating temperature	-40°C to +80°C	-40°C to +80°C	-40°C to +80°C	-40°C to +70°C [RG...DF] -40°C to +60°C [RG...AF]
Approvals/Marks	CE - cULus - VDE	CE - cULus	CE - cULus	CE - cULus
References				
DC control voltage 220 VAC, 800 Vp		RGC2A22D25KKE		
600 VAC, 1200 Vp	RGC2A60D10KKE	RGC2A60D25KKE	RGC2A60D40KGE	
AC/DC control voltage 220 VAC, 800 Vp		RGC2A22A25KKE		
600 VAC, 1200 Vp	RGC2A60A10KKE	RGC2A60A25KKE	RGC2A60A40KGE	
DC control voltage, DC external supply				RGC2A60D75GGEDF
DC control voltage, AC external supply				RGC2A60D75GGEAF
AC control voltage, AC external supply				RGC2A60A75GGEAF

Solid state contactors, 3-phase

DIN rail mounting - AC output switching with monitoring, 2 + 1 poles

Types	RGC2A..25..M 27 AAC	RGC2A..40..M 40 AAC	RGC2A..75..FM 75 AAC
Semiconductor contactors with integrated heatsink, AC operating frequency 45-65 Hz. Rated isolation voltage output to heatsink of 4000 Vrms, 100 kArms Short Circuit Current Rating			
Dimensions HxWxD (mm)	110 x 54 x 118	110 x 72 x 141	141 x 72 x 141 (with fan)
Features	54 mm solid state contactor, EMR alarm output and electronic auxiliary output, screw with clamp for power connection	72 mm solid state contactor, EMR alarm output and electronic auxiliary output, box clamp for power connection	72 mm solid state contactor, EMR alarm output and electronic auxiliary output, box clamp for power connection

Input specifications

Control input range	5-32 VDC [RG..D..DM] 5-32 VDC [RG..D..AM] 20-275 VAC [RG..A..AM]	5-32 VDC [RG..D..DM] 5-32 VDC [RG..D..AM] 20-275 VAC [RG..A..AM]	5-32 VDC [RG..D..DFM] 5-32 VDC [RG..D..AFM] 20-275 VAC [RG..A..AFM]
Control current @ max. control voltage	12.5 mADC [RG..D..DM] 5.5 mADC [RG..D..AM] 4.3 mAAC [RG..A..AM]	12.5 mADC [RG..D..DM] 5.5 mADC [RG..D..AM] 4.3 mAAC [RG..A..AM]	12.5 mADC [RG..D..DFM] 5.5 mADC [RG..D..AFM] 4.3 mAAC [RG..A..AFM]
External supply voltage	24 VDC [RG..D..DM] 90-250 VAC [RG..D..AM] 90-250 VAC [RG..A..AM]	24 VDC [RG..D..DM] 90-250 VAC [RG..D..AM] 90-250 VAC [RG..A..AM]	24 VDC [RG..D..DFM] 90-250 VAC [RG..D..AFM] 90-250 VAC [RG..A..AFM]
Max. supply current	60 mADC [RG..D..DM] 60 mAAC [RG..D..AM] 60 mAAC [RG..A..AM]	60 mADC [RG..D..DM] 60 mAAC [RG..D..AM] 60 mAAC [RG..A..AM]	150 mADC [RG..D..DFM] 80 mAAC [RG..D..AFM] 80 mAAC [RG..A..AFM]

Alarm specifications

Alarm output	EMR; 2 A 250 VAC / 30 VDC	EMR; 2 A 250 VAC / 30 VDC	EMR; 2 A 250 VAC / 30 VDC
Alarm condition	Mains loss, Load loss, SSR open cct., SSR short cct., SSR over temperature	Mains loss, Load loss, SSR open cct., SSR short cct., SSR over temperature	Mains loss, Load loss, SSR open cct., SSR short cct., SSR over temperature

Output specifications

Rated operational current AC-51 @ Ta = 40°C	27 AAC	40 AAC	75 AAC
Minimum operational current	250 mAAC	400 mAAC	500 mAAC
Non. rep. surge current I _{tsm} (t=10ms)	600 A _p	1150 A _p	1750 A _p
I ² t for fusing (t=10ms)	1800 A ² s	6600 A ² s	15000 A ² s
Off-state leakage current	3 mAAC	3 mAAC	3 mAAC

General specifications



Operational voltage range	90-600 VAC +10%	90-600 VAC +10%	90-600 VAC +10%
Blocking voltage	1200 V _p	1200 V _p	1200 V _p
Operating temperature	-40°C to +80°C [RG...DM] -40°C to +60°C [RG...AM]	-40°C to +80°C [RG...DM] -40°C to +60°C [RG...AM]	-40°C to +70°C [RG...DFM] -40°C to +60°C [RG...AFM]
Approvals/Marks	CE - cULus	CE - cULus	CE - cULus

References

600 VAC, 1200 V _p			
DC control voltage, DC external supply	RGC2A60D25GKEDM	RGC2A60D40GGEDM	RGC2A60D75GGEDFM
DC control voltage, AC external supply	RGC2A60D25GKEAM	RGC2A60D40GGEAM	RGC2A60D75GGEAFM
AC control voltage, AC external supply	RGC2A60A25GKEAM	RGC2A60A40GGEAM	RGC2A60A75GGEAFM



Solid state contactors, 3-phase

DIN rail mounting - AC output switching, 3 poles

Types	RGC3A..10.. 10 AAC	RGC3A..20.. 20 AAC	RGC3A..25.. / 30.. 28/30 AAC
Semiconductor contactors with integrated heatsink, AC operating frequency 45-65 Hz. Rated isolation voltage output to heatsink of 4000 Vrms			
Dimensions HxWxD (mm)	110 x 54 x 63.5	110 x 54 x 103	110 x 72 x 126
Features	54 mm solid state contactor, integrated varistors for over-voltage protection, 100 kArms SCCR, screw with clamp for power connection	54 mm solid state contactor, integrated varistors for over-voltage protection, 100 kArms SCCR, screw with clamp for power connection	72 mm solid state contactor, integrated varistors for over-voltage protection, 100 kArms SCCR, screw with clamp or box clamp for power connection
Input specifications			
Control input range	5-32 VDC [RGC..D.] 20-275 VAC, 24-190 VDC [RGC..A.]	5-32 VDC [RGC..D.] 20-275 VAC, 24-190 VDC [RGC..A.]	5-32 VDC [RGC..D.] 20-275 VAC, 24-190 VDC [RGC..A.]
Input current @ max. control voltage	31.5 mADC [RG..D.] 19 mAAC [RG..A.]	31.5 mADC [RG..D.] 19 mAAC [RG..A.]	31.5 mADC [RG..D.] 19 mAAC [RG..A.]
Output specifications			
Rated operational current AC-51 @ Ta = 40°C	10 AAC	20 AAC	28 AAC [RGC3..25] 30 AAC [RGC3..30]
AC-53a @ Ta = 40°C	5 AAC	10 AAC	11 AAC [RGC3..25] 14 AAC [RGC3..30]
Motor rating	1.5 kW @ 400 VAC 3 HP @ 600 VAC	4 kW @ 400 VAC 10 HP @ 600 VAC	4 kW @ 400 VAC [RGC3..25] 5.5 kW @ 400 VAC [RGC3..30] 10 HP @ 600 VAC [RGC3..25] 15 HP @ 600 VAC [RGC3..30]
Minimum operational current	250 mAAC	250 mAAC	250 mAAC [RGC3..25] 400 mAAC [RGC3..30]
Non. rep. surge current I _{sm} (t=10ms)	600 Ap	600 Ap	600 Ap [RGC3..25] 1150 Ap [RGC3..30]
I ² t for fusing (t=10ms)	1800 A ² s	1800 A ² s	1800 A ² s [RGC3..25] 6600 A ² s [RGC3..30]
Off-state leakage current	3 mAAC	3 mAAC	3 mAAC
Critical dV/dt (@ T _j init=40°C)	1000 V/us	1000 V/us	1000 V/us
General specifications			
Operational voltage range	42-220 VAC + 10% [RG..22.] 42-600 VAC +10% [RG..60.]	42-220 VAC + 10% [RG..22.] 42-600 VAC +10% [RG..60.]	42-600 VAC +10%
Blocking voltage	800 V _p [RG..22.] 1200 V _p [RG..60.]	800 V _p [RG..22.] 1200 V _p [RG..60.]	1200 V _p
Power factor	≥ 0.5 at rated voltage	≥ 0.5 at rated voltage	≥ 0.5 at rated voltage
Operating temperature	-40°C to +80°C	-40°C to +80°C	-40°C to +80°C
Approvals/Marks	CE - cULus - VDE	CE - cULus	CE - cULus
References			
DC control voltage			
220 VAC, 800 V _p	RGC3A22D10KKE	RGC3A22D20KKE	
600 VAC, 1200 V _p	RGC3A60D10KKE	RGC3A60D20KKE	28 AAC: RGC3A60D25KKE 30 AAC: RGC3A60D30KGE
AC/DC control voltage			
220 VAC, 800 V _p	RGC3A22A10KKE	RGC3A22A20KKE	
600 VAC, 1200 V _p	RGC3A60A10KKE	RGC3A60A20KKE	28 AAC: RGC3A60A25KKE 30 AAC: RGC3A60A30KGE



Solid state contactors, 3-phase

DIN rail mounting - AC output switching, 3 poles

Types	RGC3A..40..F 42 AAC	RGC3A..65..F 66 AAC
Semiconductor contactors with integrated heatsink, AC operating frequency 45-65 Hz. Rated isolation voltage output to heatsink of 4000 Vrms, 100 kArms short circuit current rating		
Dimensions HxWxD (mm)	135 x 54 x 118 (with fan)	141 x 72 x 141 (with fan)
Features	54 mm solid state contactor + fan, integrated overheat protection with EMR alarm output, box clamp for power connection	72 mm solid state contactor + fan, integrated overheat protection with EMR alarm output, box clamp for power connection
Input specifications		
Control input range	5-32 VDC [RG..D..DF] 20-275 VAC [RG..A..AF]	5-32 VDC [RG..D..DF] 5-32 VDC [RG..D..AF] 20-275 VAC [RG..A..AF]
Input current @ max. control voltage	12.5 mADC [RG..D..DF] 4.3 mAAC [RG..A..AF]	12.5 mADC [RG..D..DF] 5.5 mADC [RG..D..AF] 4.3 mAAC [RG..A..AF]
External supply voltage	24 VDC [RG..D..DF] 90-250 VAC [RG..A..AF]	24 VDC [RG..D..DF] 90-250 VAC [RG..D..AF] 90-250 VAC [RG..A..AF]
Max. supply current	150 mADC [RG..D..DF] 80 mAAC [RG..A..AF]	150 mADC [RG..D..DF] 80 mAAC [RG..D..AF] 80 mAAC [RG..A..AF]
Alarm specifications		
Alarm output	EMR; 2 A 250 VAC / 30 VDC	EMR; 2 A 250 VAC / 30 VDC
Alarm condition	Over temperature	Over temperature
Output specifications		
Rated operational current AC-51 @ Ta = 40°C	42 AAC	66 AAC
AC-53a @ Ta = 40°C	17 AAC	25 AAC
Motor rating	7.5 kW @ 400 VAC 15 HP @ 600 VAC	11 kW @ 400 VAC 25 HP @ 600 VAC
Minimum operational current	400 mAAC	500 mAAC
Non. rep. surge current I _{tsm} (t=10ms)	1150 A _p	1750 A _p
I ² t for fusing (t=10ms)	6600 A ² s	15000 A ² s
Off-state leakage current	3 mAAC	3 mAAC
Critical dV/dt (@ T _j init=40°C)	1000 V/us	1000 V/us
General specifications		
Operational voltage range	42-600 VAC +10%	42-600 VAC +10%
Blocking voltage	1200 V _p	1200 V _p
Power factor	≥ 0.5 at rated voltage	≥ 0.5 at rated voltage
Operating temperature	-40°C to +70°C [RGC..D..DF] -40°C to +60°C [RGC..A..AF]	-40°C to +70°C [RGC..D..DF] -40°C to +60°C [RGC..AF]
Approvals/Marks	CE - cULus	CE - cULus
References		
600 VAC, 1200 V _p		
DC control voltage, DC external supply	RGC3A60D40GGEDF	RGC3A60D65GGEDF
DC control voltage, AC external supply		RGC3A60D65GGEAF
AC control voltage, AC external supply	RGC3A60A40GGEAF	RGC3A60A65GGEAF



Solid state contactors, 3-phase

DIN rail mounting - AC output switching with monitoring, 3 poles

Types	RGC3A..20..M 20 AAC	RGC3A..25/30..M 28/30 AAC	RGC3A..65..FM 66 AAC
Semiconductor contactors with integrated heatsink, AC operating frequency 45-65 Hz. Rated isolation voltage output to heatsink of 4000 Vrms, 100 kArms SCCR			
Dimensions HxWxD (mm)	110 x 54 x 118	110 x 72 x 141	141 x 72 x 141 (with fan)
Features	54 mm solid state contactor, EMR alarm output and electronic auxiliary output, screw with clamp for power connection	72 mm solid state contactor, EMR alarm output and electronic auxiliary output, screw with clamp or box clamp for power connection	72 mm solid state contactor + fan, EMR alarm output and electronic auxiliary output, box clamp for power connection
Input specifications			
Control input range	5-32 VDC [RG..D..DM] 5-32 VDC [RG..D..AM] 20-275 VAC [RG..A..AM]	5-32 VDC [RG..D..DM] 5-32 VDC [RG..D..AM] 20-275 VAC [RG..A..AM]	5-32 VDC [RG..D..DFM] 5-32 VDC [RG..D..AFM] 20-275 VAC [RG..A..AFM]
Control current @ max. control voltage	12.5 mADC [RG..D..DM] 5.5 mADC [RG..D..AM] 4.3 mAAC [RG..A..AM]	12.5 mADC [RG..D..DM] 5.5 mADC [RG..D..AM] 4.3 mAAC [RG..A..AM]	12.5 mADC [RG..D..DFM] 5.5 mADC [RG..D..AFM] 4.3 mAAC [RG..A..AFM]
External supply voltage	24 VDC [RG..D..DM] 90-250 VAC [RG..D..AM] 90-250 VAC [RG..A..AM]	24 VDC [RG..D..DM] 90-250 VAC [RG..D..AM] 90-250 VAC [RG..A..AM]	24 VDC [RG..D..DFM] 90-250 VAC [RG..D..AFM] 90-250 VAC [RG..A..AFM]
Max. supply current	60 mADC [RG..D..DM] 60 mAAC [RG..D..AM] 60 mAAC [RG..A..AM]	60 mADC [RG..D..DM] 60 mAAC [RG..D..AM] 60 mAAC [RG..A..AM]	150 mADC [RG..D..DFM] 80 mAAC [RG..D..AFM] 80 mAAC [RG..A..AFM]
Alarm specifications			
Alarm output	EMR; 2 A 250 VAC / 30 VDC	EMR; 2 A 250 VAC / 30 VDC	EMR; 2 A 250 VAC / 30 VDC
Alarm condition	Mains loss, Load loss, SSR open cct., SSR short cct., SSR over temperature	Mains loss, Load loss, SSR open cct., SSR short cct., SSR over temperature	Mains loss, Load loss, SSR open cct., SSR short cct., SSR over temperature
Output specifications			
Rated operational current AC-51 @ Ta = 40°C	20 AAC	28 AAC [RGC3..25] 30 AAC [RGC3..30]	66 AAC
Minimum operational current	250 mAAC	250 mAAC [RGC3..25] 400 mAAC [RGC3..30]	500 mAAC
Non. rep. surge current I _{tsm} (t=10ms)	600 A _p	600 A _p [RGC3..25] 1150 A _p [RGC3..30]	1750 A _p
Off-state leakage current	3 mAAC	3 mAAC	3 mAAC
I ² t for fusing (t=10ms)	1800 A ² s	1800 A ² s [RGC3..25] 6600A ² s [RGC3..30]	15000 A ² s
Critical dV/dt (@ T _j init=40°C)	1000 V/us	1000 V/us	1000 V/us
General specifications			
Operational voltage range	90-600 VAC +10%	90-600 VAC +10%	90-600 VAC +10%
Blocking voltage	1200 V _p	1200 V _p	1200 V _p
Operating temperature	-40°C to +80°C [RG...DM] -40°C to +60°C [RG...AM]	-40°C to +80°C [RG...DM] -40°C to +60°C [RG...AM]	-40°C to +70°C [RG...DFM] -40°C to +60°C [RG...AFM]
Approvals/Marks	CE - cULus	CE - cULus	CE - cULus
References			
DC control voltage, DC external supply	RGC3A60D20GKEDM	28AAC: RGC3A60D25GKEDM 30AAC: RGC3A60D30GGEDM	RGC3A60D65GGEDFM
DC control voltage, AC external supply	RGC3A60D20GKEAM	28AAC: RGC3A60D25GKEAM 30AAC: RGC3A60D30GGEAM	RGC3A60D65GGEAFM
AC control voltage, AC external supply	RGC3A60A20GKEAM	28AAC: RGC3A60A25GKEAM 30AAC: RGC3A60A30GGEAM	RGC3A60A65GGEAFM



Solid state contactors, 3-phase

4-20 mA Proportional controllers, 2 + 1 poles

Types	RGC2P60AA15C1 15 AAC	RGC2P60AA25C1 27 AAC	RGC2P60AA40C1 40 AAC
3-phase semiconductor proportional controllers with integrated heatsink, AC operating frequency range 45-65 Hz. Rated isolation voltage 4000 Vrms, 100 kArms short circuit current rating			
Dimensions HxWxD (mm)	110 x 54 x 103	110 x 54 x 103	110 x 72 x 126
Features	54 mm solid state contactor with integrated varistors for over-voltage protection, screw with clamp for power connection	54 mm solid state contactor with integrated varistors for over-voltage protection, screw with clamp for power connection	72 mm solid state contactor, integrated varistors for over-voltage protection, box clamp for power connection
Input specifications			
Control input	4-20 mADC	4-20 mADC	4-20 mADC
Voltage drop	<10 VDC @ 20 mADC	<10 VDC @ 20 mADC	<10 VDC @ 20 mADC
Types			
Switching mode	1 Full Cycle [RGC..C1..]	1 Full Cycle [RGC..C1..]	1 Full Cycle [RGC..C1..]
Output specifications			
Rated operational current AC-51 @ Ta = 40°C	15 AAC	27 AAC	40 AAC
Minimum operational current	500 mAAC	500 mAAC	500 mAAC
Non. rep. surge current I _{sm} (t=10ms)	600 A _p	600 A _p	1150 A _p
I ² t for fusing (t=10ms)	1800 A ² s	1800 A ² s	6600 A ² s
Off-state leakage current	5 mAAC	5 mAAC	5 mAAC
Critical dV/dt (@ T _j init=40°C)	1000 V/us	1000 V/us	1000 V/us
General specifications			
Operational voltage range	180-600 VAC +10%	180-600 VAC +10%	180-600 VAC +10%
Blocking voltage	1200 V _p	1200 V _p	1200 V _p
Power factor	≥ 0.7 at rated voltage	≥ 0.7 at rated voltage	≥ 0.7 at rated voltage
Operating temperature	-40°C to +70°C	-40°C to +70°C	-40°C to +70°C
Approvals/Marks	CE - cULus	CE - cULus	CE - cULus
References			
Control Input:	4-20 mADC	4-20 mADC	4-20 mADC
1 Full Cycle	RGC2P60AA15C1	RGC2P60AA25C1	RGC2P60AA40C1

Solid state contactors, 3-phase

Proportional controllers with monitoring, 2 + 1 poles

Types	RGC2P..25..M 27 AAC	RGC2P..40..M 40 AAC	RGC2P..75..FM 75 AAC
Semiconductor contactors with integrated heatsink, AC operating frequency 45-65 Hz. Rated isolation voltage output to heatsink of 4000 Vrms, 100 kArms short circuit current rating			
Dimensions HxWxD (mm)	110 x 54 x 118	110 x 72 x 141	141 x 72 x 141 (with fan)
Features	54 mm solid state contactor with integrated varistors for over-voltage protection, system monitoring, screw with clamp for power connection	72 mm solid state contactor with integrated varistors for over-voltage protection, system monitoring, box clamp for power connection	72 mm solid state contactor with fan and system monitoring, integrated varistors for over-voltage protection, box clamp for power connection
Input specifications			
Control input	0-20, 4-20, 12-20 mADC [RGC..I..] 0-10, 0-5, 1-5 VDC [RGC..V..] External potentiometer [RGC..V..]	0-20, 4-20, 12-20 mADC [RGC..I..] 0-10, 0-5, 1-5 VDC [RGC..V..] External potentiometer [RGC..V..]	0-20, 4-20, 12-20 mADC [RGC..I..] 0-10, 0-5, 1-5 VDC [RGC..V..] External potentiometer [RGC..V..]
Input impedance	<250 ohms [RGC..I..] 100k ohms [RGC..V..]	<250 ohms [RGC..I..] 100k ohms [RGC..V..]	<250 ohms [RGC..I..] 100k ohms [RGC..V..]
External supply voltage	24 VDC/AC	24 VDC/AC	24 VDC/AC [RGC..DFM] 90-250 VAC [RGC..AFM]
Max. supply current	90 mADC/AC	90 mADC/AC	175 mADC/AC [RGC..DFM] 60 mAAC [RGC..AFM]
Alarm specifications			
Alarm output	EMR; 2 A 250 VAC / 30 VDC	EMR; 2 A 250 VAC / 30 VDC	EMR; 2 A 250 VAC / 30 VDC
Alarm condition	Mains loss, Load loss, SSR open cct., SSR short cct., SSR over temperature	Mains loss, Load loss, SSR open cct., SSR short cct., SSR over temperature	Mains loss, Load loss, SSR open cct., SSR short cct., SSR over temperature
Types			
Switching mode	1 Full Cycle [RGC..C1..] 4 Full Cycles [RGC..C4..]	1 Full Cycle [RGC..C1..] 4 Full Cycles [RGC..C4..]	1 Full Cycle [RGC..C1..] 4 Full Cycles [RGC..C4..]
Output specifications			
Rated operational current AC-51 @ Ta = 40°C	27 AAC	40 AAC	75 AAC
Minimum operational current	500 mAAC	500 mAAC	500 mAAC
Non. rep. surge current I _{tsm} (t=10ms)	600 Ap	1150 Ap	1750 Ap
I ² t for fusing (t=10ms)	1800 A ² s	6600 A ² s	15000 A ² s
Off-state leakage current	5 mAAC	5 mAAC	5 mAAC
Critical dV/dt (@ Tj init=40°C)	1000 V/us	1000 V/us	1000 V/us
General specifications			
Operational voltage range	180-600 VAC +10%	180-600 VAC +10%	180-600 VAC +10%
Blocking voltage	1200 Vp	1200 Vp	1200 Vp
Power factor	≥ 0.7 at rated voltage	≥ 0.7 at rated voltage	≥ 0.7 at rated voltage
Operating temperature	-40°C to +70°C max. +60°C for 24 VAC supply	-40°C to +70°C max. +60°C for 24 VAC supply	-40°C to +70°C max. +60°C for 24 VAC supply
Approvals/Marks	CE - cULus	CE - cULus	CE - cULus
References			
Control Input:	0-20, 4-20, 12-20 mADC	0-20, 4-20, 12-20 mADC	0-20, 4-20, 12-20 mADC
1 Full Cycle, DC external supply	RGC2P60I25C1DM	RGC2P60I40C1DM	RGC2P60I75C1DFM
1 Full Cycle, AC external supply			RGC2P60I75C1AFM
4 Full Cycles, DC external supply	RGC2P60I25C4DM	RGC2P60I40C4DM	RGC2P60I75C4DFM
4 Full Cycles, AC external supply			RGC2P60I75C4AFM
Control Input:	0-10, 0-5, 1-5 VDC, Pot	0-10, 0-5, 1-5 VDC, Pot	0-10, 0-5, 1-5 VDC, Pot
1 Full Cycle, DC external supply	RGC2P60V25C1DM	RGC2P60V40C1DM	RGC2P60V75C1DFM
1 Full Cycle, AC external supply			RGC2P60V75C1AFM

Solid state contactors, 3-phase

4-20 mA Proportional controllers, 3 poles

Types

RGC3P60AA20..
20 AAC

RGC3P60AA30..
30 AAC

3-phase semiconductor proportional controllers with integrated heatsink, AC operating frequency range 45-65 Hz. Rated isolation voltage 4000 Vrms, 100 kArms short circuit current rating



Dimensions HxWxD (mm)

110 x 54 x 103

110 x 72 x 126

Features

54 mm solid state contactor with integrated varistors for over-voltage protection, screw with clamp for power connection

72 mm solid state contactor, integrated varistors for over-voltage protection, box clamp for power connection

Input specifications

Control input

4-20 mADC

4-20 mADC

Voltage drop

<10 VDC @ 20 mADC

<10 VDC @ 20 mADC

Types

Switching mode

Phase Angle [RGC..E]
1 Full Cycle [RGC..C1]

Phase Angle [RGC..E]
1 Full Cycle [RGC..C1]

Output specifications

Rated operational current
AC-51 @ Ta = 40°C

20 AAC

30 AAC

Minimum operational current

500 mAAC

500 mAAC

Non. rep. surge current I_{tsm}
(t=10ms)

600 A_p

1150 A_p

I²t for fusing (t=10ms)

1800 A²s

6600 A²s

Off-state leakage current

5 mAAC

5 mAAC

Critical dV/dt
(@ T_j init=40°C)

1000 V/us

1000 V/us

General specifications

Operational voltage range

180-600 VAC +10%

180-600 VAC +10%

Blocking voltage

1200 V_p

1200 V_p

Power factor

≥ 0.7 at rated voltage

≥ 0.7 at rated voltage

Operating temperature

-40°C to +70°C

-40°C to +70°C

Approvals/Marks

CE - cULus

CE - cULus

References

Control Input:

4-20 mADC

4-20 mADC

Phase Angle

RGC3P60AA20E

RGC3P60AA30E



1 Full Cycle

RGC3P60AA20C1

RGC3P60AA30C1

Solid state contactors, 3-phase

Proportional controllers with monitoring, 3 poles

Types	RGC3P..20..EP RGC3P..20..M 20 AAC	RGC3P..30..EP RGC3P..30..M 30 AAC	RGC3P..65..EPF RGC3P..65..FM 66 AAC
Semiconductor contactors with integrated heatsink, AC operating frequency 45-65 Hz. Rated isolation voltage output to heatsink of 4000 Vrms, 100 kArms short circuit current rating			
Dimensions HxWxD (mm)	110 x 54 x 118	110 x 72 x 141	141 x 72 x 141 (with fan)
Features	54 mm solid state contactor with integrated varistors for over-voltage protection, system monitoring, screw with clamp for power connection	72 mm solid state contactor with integrated varistors for over-voltage protection, system monitoring, box clamp for power connection	72 mm solid state contactor with fan and system monitoring, integrated varistors for over-voltage protection, box clamp for power connection
Input specifications			
Control input	0-20, 4-20, 12-20 mADC [RGC..I..] 0-10, 0-5, 1-5 VDC [RGC..V..] External potentiometer [RGC..V..]	0-20, 4-20, 12-20 mADC [RGC..I..] 0-10, 0-5, 1-5 VDC [RGC..V..] External potentiometer [RGC..V..]	0-20, 4-20, 12-20 mADC [RGC..I..] 0-10, 0-5, 1-5 VDC [RGC..V..] External potentiometer [RGC..V..]
Input impedance	<250 ohms [RGC..I..] 100k ohms [RGC..V..]	<250 ohms [RGC..I..] 100k ohms [RGC..V..]	<250 ohms [RGC..I..] 100k ohms [RGC..V..]
External supply voltage	24 VDC/AC [RGC..DM] 90-250 VAC [RGC..AM]	24 VDC/AC [RGC..DM] 90-250 VAC [RGC..AM]	24 VDC/AC [RGC..DFM] 90-250 VAC [RGC..AFM]
Max. supply current	90 mADC/AC [RGC..DM] 30 mAAC [RGC..AM]	90 mADC/AC [RGC..DM] 30 mAAC [RGC..AM]	175 mADC/AC [RGC..DFM] 60 mAAC [RGC..AFM]
Alarm specifications			
Alarm output	EMR; 2 A 250 VAC / 30 VDC	EMR; 2 A 250 VAC / 30 VDC	EMR; 2 A 250 VAC / 30 VDC
Alarm condition	Mains loss, Load loss, SSR open cct., SSR short cct., SSR over temperature	Mains loss, Load loss, SSR open cct., SSR short cct., SSR over temperature	Mains loss, Load loss, SSR open cct., SSR short cct., SSR over temperature
Types			
Switching mode	Phase Angle [RGC..E..] 1 Full Cycle [RGC..C1..] 4 Full Cycles [RGC..C4..] 16 Full Cycles [RGC..C16..] Softstart [RGC..S..]	Phase Angle [RGC..E..] 1 Full Cycle [RGC..C1..] 4 Full Cycles [RGC..C4..] 16 Full Cycles [RGC..C16..] Softstart [RGC..S..]	Phase Angle [RGC..E..] 1 Full Cycle [RGC..C1..] 4 Full Cycles [RGC..C4..] 16 Full Cycles [RGC..C16..] Softstart [RGC..S..]
Output specifications			
Rated operational current AC-51 @ Ta = 40°C	20 AAC	30 AAC	66 AAC
Minimum operational current	500 mAAC	500 mAAC	500 mAAC
Non. rep. surge current I _{tsm} (t=10ms)	600 Ap	1150 Ap	1750 Ap
I ² t for fusing (t=10ms)	1800 A ² s	6600 A ² s	15000 A ² s
Off-state leakage current	5 mAAC	5 mAAC	5 mAAC
Critical dV/dt (@ Tj init = 40°C)	1000 V/us	1000 V/us	1000 V/us
General specifications			
Operational voltage range	180-600 VAC +10%	180-600 VAC +10%	180-600 VAC +10%
Blocking voltage	1200 Vp	1200 Vp	1200 Vp
Power factor	≥ 0.7 at rated voltage	≥ 0.7 at rated voltage	≥ 0.7 at rated voltage
Operating temperature	-40°C to +70°C max. +60°C for 24 VAC supply	-40°C to +70°C max. +60°C for 24 VAC supply	-40°C to +70°C max. +60°C for 24 VAC supply
Approvals/Marks	CE - cULus	CE - cULus	CE - cULus
References			
Phase Angle, DC external supply	RGC3P60Y20EDP	RGC3P60Y30EDP	RGC3P60Y65EDFP
Phase Angle, AC external supply	RGC3P60Y20EAP	RGC3P60Y30EAP	RGC3P60Y65EAFP
X Full Cycle, DC external supply	RGC3P60Y20CXDM (X = 1/4/16)	RGC3P60Y30CXDM (X = 1/4/16)	RGC3P60Y65CXDFM (X = 1/4/16)
X Full Cycle, AC external supply	RGC3P60Y20CXAM (X = 1/4/16)	RGC3P60Y30CXAM (X = 1/4/16)	RGC3P60Y65CXAFM (X = 1/4/16)
Softstart + 16 Full Cycles, DC external supply	RGC3P60V20S16DM	RGC3P60V30S16DM	RGC3P60V65S16DFM
Digital Control Input (5-10VDC):	5-10VDC	5-10VDC	5-10VDC
Softstart + ON/OFF, DC external supply	RGC3P60V20SDM	RGC3P60V30SDM	RGC3P60V65SDFM

Y = 'I' for 0-20 mA, 4-20 mA or 12-20 mA or 'V' for 0-10 V, 0-5 V, 1-5 V or pot

45 mm Solid state contactors for motor switching, 3-phase

Ready for use design - DIN rail mounting

Types

REC2B
4 kW

REC3B
3 kW

REC2R
3 kW

Semiconductor contactors with integrated heatsink.
AC operating frequency range 45-65 Hz.
Rated isolation voltage ≥ 4000 Vrms



Dimensions HxWxD (mm)	105 x 45 x 99.4	105 x 45 x 99.4	105 x 45 x 99.4
Features	2-phase switching electronic motor contactor	3-phase switching electronic motor contactor	2-phase switching electronic motor contactor for reversing

Control specifications

Control input range	15-32 VDC [REC..D] 90-253 VAC [REC..A]	15-32 VDC [REC..D] 90-253 VAC [REC..A]	15-32 VDC [REC..D] 90-253 VAC [REC..A]
Max. input current	10 mADC [REC..D] 15 mAAC [REC..A]	10 mADC [REC..D] 15 mAAC [REC..A]	10 mADC [REC..D] 15 mAAC [REC..A]

Output specifications

Rated operational current ACS3a @ Ta= 40°C, 400 VAC	6.2 AAC [REC2B..20] 7.6 AAC [REC2B..30] 9.2 AAC [REC2B..40]	5.8 AAC [REC3B..20] 5.8 AAC [REC3B..21] 7.6 AAC [REC3B..30]	6.2 AAC [REC2R..20] 7.6 AAC [REC2R..30]
Motor Rating @ 400 VAC UL508/IEC60947-4-2 @40°C	3 HP / 2.2 kW [REC2B..20] 3 HP / 3.0 kW [REC2B..30] 3 HP / 4.0 kW [REC2B..40]	2 HP / 2.2 kW [REC3B..20] 2 HP / 2.2 kW [REC3B..21] 3 HP / 3.0 kW [REC3B..30]	3 HP / 2.2 kW [REC2R..20] 3 HP / 3.0 kW [REC2R..30]
Min. operational current	150 mA [RECB..20]	150 mA [REC3B..20]	150 mA [REC2R..20]
Non repet. surge current (I _{tsm}) (t=10 ms)	325 A _p [REC2B..20] 600 A _p [REC2B..30] 800 A _p [REC2B..40]	325 A _p [REC3B48..20] 600 A _p [REC3B60..20] 600 A _p [REC3..21] 800 A _p [REC3..30]	600 A _p
Max. Off-state leak current	< 3 mAAC	< 3 mAAC	< 3 mAAC
I ² t for fusing (t=10 ms)	525 A ² s [REC2..20] 525 A ² s [REC2..48..30] 1800 A ² s [REC2..60..30] 3200 A ² s [REC2..40]	525 A ² s [REC3B48..20] 1800 A ² s [REC3B60..20] 1800 A ² s [REC3..21] 3200 A ² s [REC3..40]	1800 A ² s
Critical dV/dt (@ T _j init=40°C)	1000 V/μs	1000 V/μs	1000 V/μs

General specifications





Operational voltage range	48 - 530 VAC [REC..48..] 48 - 600 VAC [REC..60..]	48 - 530 VAC [REC..48..] 48 - 600 VAC [REC..60..]	48 - 530 VAC [REC..48..] 48 - 600 VAC [REC..60..]
Blocking voltage	1200 V _p [REC..48..] 1600 V _p [REC..60..]	1200 V _p [REC..48..] 1600 V _p [REC..60..]	1200 V _p [REC..48..] 1600 V _p [REC..60..]
Power factor	≥ 0.5 at rated voltage	≥ 0.5 at rated voltage	≥ 0.5 at rated voltage
Operating temperature	-25°C to +60°C	-25°C to +60°C	-25°C to +60°C
Terminals	input screw/spring, output screw	input screw/spring, output screw	input screw/spring, output screw
Approvals/Marks	CE - cULus	CE - cULus	CE - cULus

References

2.2 kW	2.2 kW	2.2 kW
REC2B48D20GKE	REC3B48D20GKE	REC2R48D20GKE
REC2B48A20GKE	REC3B48A20GKE	REC2R48A20GKE
3.0 kW	3.0 kW	3.0 kW
REC2B48D30GKE	REC3B60D20GKE	REC2R48D30GKE
REC2B48A30GKE	REC3B60A20GKE	REC2R48A30GKE
REC2B60D30GKE	2.2 kW (high I _{tsm})	REC2R60D30GKE
REC2B60A30GKE	REC3B48D21GKE	REC2R60A30GKE
4.0 kW	3.0 kW	
REC2B48D40GKE	REC3B48D30GKE	
REC2B48A40GKE	REC3B48A30GKE	





Solid state relays accessories

General accessories

Types	RPM1	RPM1P	RPM1V	RPM2
				
Dimensions HxWxD (mm)	84 x 12.5 x 42	84 x 12.5 x 42	84 x 12.5 x 42	82 x 25 x 39
Description	Din-rail adaptor for PCB relays. (Relay excluded)	Din-rail adaptor with sockets for plug-in PCB relays. (Relay excluded)	DIN-rail adaptor for PCB relays with LED and varistor across output terminals. (Relay excluded)	Din-rail adaptor for PCB relays with an operational voltage ≥ 230 V. (Relay excluded)
Pack quantity	1	1	1	2
References	RPM1	RPM1P (no LED) RPM1PD (with LED)	RPM1V	RPM2

Selection guide for SSR assemblies*

RP...M1	RP...M1P (no LED) RP...M1PD (with LED)	RP...M1V	RP...M2
----------------	---	-----------------	----------------

Types	DIN Adaptor	DIN Adaptor RG	Protection cover RM/RA/RK	Tamper proof cover RGS1P, RGC1P
				
Dimensions HxWxD (mm)	81 x 44 x 13.5	106 x 17.8 x 14	58 x 45 x 9 / 26	59 x 45 x 25.5
Description	DIN-rail adaptor for 1-phase SSR & heatsink assemblies. Integrated in heatsink kits.	DIN-rail adaptor for RGS relays.	Clip-on IP20 protection Cover	Tamper proof protection cover for RGS1P, RGC1P
Pack quantity	1	1	10 (RK)/20 (RMIP20)/25 (BBR..)	5
References	RHS00	RGS1DIN	RMIP20 (for RM, RS, RAM series) RKIP20 (for RK series) BBR (for RA, RD series) BBR-S (for RA...S series)	RGTMP

Selection guide for SSR assemblies*

R...H8	RGS...DIN
---------------	------------------

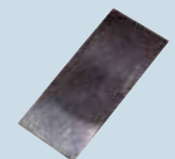
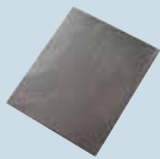
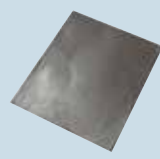



Types	Thermal paste	Thermal pad Slim SSRs	Thermal Pad RM, RA	Thermal pad RZ3
				
Dimensions HxWxD (mm)		34.6 x 14 x 0.13 (RG) 21 x 19 x 0.13 (RF) 23.8 x 11.2 x 0.20 (RK)	42 x 35 x 0.25	70 x 77 x 0.25
Description	2 ml syringe silicon based thermal compound	Thermal pad for RG, RF and RK series	Graphite thermal pad for RA, RD, RM, RAM, RS series	Graphite thermal pad for RZ3 series
Pack quantity	1	10	50	10
References	HTS02S	RGHT (for RG series) RFHT (for RF series) RKHT (for RK series)	KK071CUT	RZHT





* Conditions may apply. Please ask your Sales representative for further details.





CARLO GAVAZZI Automation Components. Specifications are subject to change without notice. Illustrations are for example only.

Solid state relays accessories

Terminal Adaptors

Types	RM fork terminal	RM FASTON terminals	RM spacers	Overload Relay Adaptor
				
Dimensions HxWxD (mm)	35 x 16.5 x 25 / 29	4.8 / 6.3	M3 x 12	
Description	RM, RS, RK and RAM terminal adaptor for 16 mm ² and 35 mm ² cable	Screw FASTON terminals, flat or 45° angled for output (6.3 mm) and input (4.8 mm) RM, RS, RAM terminals	Standoff spacer for RM, RS, RAM series M3 control terminals	Overload Relay Adaptor for REC and RGC3 series
Pack quantity	10	20	20	5
References	RM625FK (16 mm ²) RM635FK (35 mm ²) RM635FKP (35 mm ²)	RM48FO (4.8 mm, flat) RM48F4 (4.8 mm, 45°) RM63FO (6.3 mm, flat) RM63F4 (6.3 mm, 45°)	RMSPO3	REC3ADAPTOR

Types	RG plug terminals	RGCM plug terminals	RK plug terminals	Varistors
				
Description	2 pole spring loaded plug terminal, 2.5 mm ² for RG series	3 way, 2 pole box clamp plug terminal, 2.5 mm ² for RGC3 series	4 way, 4 pole / 2 pole spring loaded plug terminal, 5.08 mm for RK series	Surge / transient voltage protection for SSRs
Pack quantity	10	10	10	10
References	RGM25	RG3G25	RK4MT (4 way, 4-pole) RK2MT (4 way, 2-pole)	275 V: RV02 420 V: RV04 510 V: RV05 625 V: RV06 680 V: RV07

Types	Cables	Fans	Screw Kits	Temperature limit switches
				
Dimensions HxWxD (mm)		40 x 40 x 20 (RHSF40) 60 x 60 x 20 (RHSF60) 120 x 120 x 38 (RHS301F)		6.5 x 5.5 x 3
Description	Cable for RM1E...V, RA2A...C, RK...C and RA...S models with one-end terminated with a female plug for mounting on the SSR	RHSF40-24 to be mounted with RHS45C, RHS45B, RHS540, RHS542 RHSF60-24/240 to be mounted with RHS90A, RHS112A, RHS703 RHS301F115/230 to be mounted with RHS301 incl. bracket	Screw kits for assembling SSRs to heatsinks. M5 x 10 mm to be used with RA, RD, RM, RAM, RS, RK and RZ3 series. M4 x 15 mm used for RHS38AD heatsink. M5 x 23 / 30 mm to be used with RG series.	Temperature limit switches that may be fitted in the RZ3 housing between SSR and heatsink
	1	1	20	1
References	RCS3-100-1 [RM1E..V] RCS4-100-1 [RA2A..C] RCS4-400-1 [RA2A..C] RCS5-200-1 [RA..S] RCK4-100-1 [RK2..C] RCK2-100-1 [RK2..C]	RHSF40-24 (24 VDC) RHSF60-24 (24 VDC) RHSF60-230 (240 VAC) RHS301F115 (115 VAC) RHS301F230 (230 VAC)	SRWKITM5X10MM SRWKITM4X15MM SRWKITM5X23MM SRWKITM5X30MM	UP62-70 UP62-80 UP62-90

Solid state relays accessories

DIN mount heatsinks for solid state relays

Types	RHS300	RHS37A	RHS10015
			

Dimensions HxWxD (mm) (SSR not included)	105 x 82 x 20	18 x 110 x 52	100 x 82 x 29
Description	Heatsink for 1x 3-phase RZ3 series	Heatsink for 1x 1-phase RG series	Heatsink for max. 2x 1-phase RA, RD, RM, RAM, RS and RK series

Thermal resistance**

Without fan	5.40°C/W (>30 W)	4.00°C/W (>20 W)	4.00°C/W (>30 W)
With fan	Not available	Not available	Not available

Selection guide for heatsink assemblies*

Without fan	R...H1	R...H51	R...H47
With fan	Not available	Not available	Not available

Types	RHS100	RHS45C	RHS52A
			

Dimensions HxWxD (mm) (SSR not included)	44 x 82 x 48	45 x 103 x 55	22.5 x 110 x 90
Description	Heatsink for 1x 1-phase RA, RD, RM, RAM, RS and RK series	Heatsink for 1x 1-phase RA, RD, RM, RAM, RS and RK series	Heatsink for 1x 1-phase RG series

Thermal resistance**

Without fan	3.10°C/W (>25 W)	2.20°C/W (>45 W)	2.00°C/W (>45 W)
With fan	Not available	Not available	Not available

Selection guide for heatsink assemblies*

Without fan	R...H0	R...H15	R...H61
With fan	Not available	Not available	Not available

Types	RHS45B	RHS54..	RHS703..
			

Dimensions HxWxD (mm) (SSR not included)	45 x 103 x 80	54 x 110 x 51 54 x 135 x 51 (with fan)	72 x 110 x 75 72 x 141 x 75 (with fan)
Description	Heatsink for 1x 1-phase RA, RD, RM, RAM, RS and RK series	Heatsink for max. 3x 1-phase RG series, 1x 1-phase RA, RD, RM, RAM, RS and RK series: RHS540 (no fan) RHS540F40-24 (24 VDC fan) Heatsink for max. 2x 1-phase RG series: RHS542 (no fan) RHS542F40-24 (24 VDC fan)	Heatsink for max. 3x 1-phase RG series, 1x 1-phase RA, RD, RM, RAM, RS and RK series: RHS703 (no fan) RHS703F60-24 (24 VDC fan) RHS703F60-230 (240 VAC fan)

Thermal resistance**

Without fan	1.85°C/W (>50 W)	1.85°C/W (>60 W)	1.10°C/W (>60 W)
With fan	Not available	0.65°C/W	0.37°C/W

Selection guide for heatsink assemblies*



Without fan	R...H5	R...H65 [RHS540] R...H66 [RHS542]	R...H75 [RHS703]
With fan	Not available	R...H67 [RHS540F40-24] R...H68 [RHS542F40-24]	R...H76 [RHS703F60-24] R...H77 [RHS703F60-230]

* Conditions may apply. Please ask your Sales representative for further details.

** Refer to specific heatsink datasheet for further details on heatsink characteristics and assemblies.

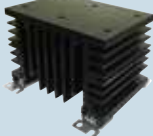

Solid state relays accessories

DIN mount heatsinks for solid state relays

Types	RHS90A	RHS301..	RHS112A..
			
Dimensions HxWxD (mm) (SSR not included)	90 x 103 x 80	119 x 82 x 94 124 x 146 x 122 (with fan)	112 x 103 x 80 112 x 120 x 80 (with fan)
Description	Heatsink for 1x 1-phase RA, RD, RM, RAM, RS and RK series	Heatsink for 1x 3-phase RZ3, 2x 1-phase RA, RD, RM, RAM, RS and RK series: RHS301 [no fan] RHS301F115C [115 VAC fan] RHS301F230C [230 VAC fan]	Heatsink for 1x 3-phase RZ3, 2x 1-phase RA, RD, RM, RAM, RS and RK series: RHS112A [no fan] RHS112AF60-24 [24 VDC fan] RHS112AF60-230 [230 VAC fan]
Thermal resistance**			
Without fan	0.97°C/W (>60 W)	0.82°C/W (> 80W)	0.76°C/W (>100 W)
With fan	Not available	0.28°C/W	0.35°C/W
Selection guide for heatsink assemblies*			
Without fan	R...H16	R...H2 [RHS301]	R...H7
With fan	Not available	R...H10 [RHS301F115C] R...H12 [RHS301F230C]	R...H18 [RHS112AF60-24] R...H52 [RHS112AF60-230]

Types	RHS11267DIND	RHS28009F80-24P	RHS28011F80-24P
			
Dimensions HxWxD (mm) (SSR not included)	119 x 125 x 94	280 x 87 x 122	280 x 87 x 122
Description	Heatsink for 1x 3-phase RZ3 series, max 3x 1-phase RG series, 2x 1-phase RA, RD, RM, RAM, RS and RK series	Heatsink for max. 9x 1-phase RG series or 4x 1-phase RA, RD, RM, RAM, RS and RK series with integrated fan and overtemperature protection	Heatsink for max. 11x 1-phase RG series or 3x 1-phase RA, RD, RM, RAM, RS and RK series with integrated fan and overtemperature protection
Thermal resistance**			
Without fan	0.54°C/W (>150 W)	Not available	Not available
With fan	Not available	0.12°C/W (24 VDC)	0.12°C/W (24 VDC)
Selection guide for heatsink assemblies*			
Without fan	R...H78D	Not available	Not available
With fan	Not available	R...H41	R...H44

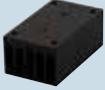
Thru wall mount heatsinks for solid state relays

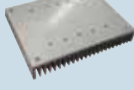
Types	RHS38ARFD	RHS10025D	RHS16225D
			
Dimensions HxWxD (mm) (SSR not included)	46 x 76 x 33	100 x 100 x 25	162 x 100 x 25
Description	Heatsink for 1x 1-phase RF series	Heatsink for max. 3x 1-phase RG series, 1x 1-phase RA, RD, RM, RAM, RS and RK series	Heatsink for 1x 3-phase RZ3 series, max. 3x 1-phase RA, RD, RM, RAM, RS, RK and RG series
Thermal resistance**			
Without fan	2.85°C/W (>40 W)	1.85°C/W (>60 W)	1.30°C/W (>90 W)
With fan	Not available	Not available	Not available
Selection guide for heatsink assemblies*			
Without fan	R..H53	R...H49	R...H55
With fan	Not available	Not available	Not available

* Conditions may apply. Please ask your Sales representative for further details.
** Refer to specific heatsink datasheet for further details on heatsink characteristics and assemblies.

Solid state relays accessories

Thru wall mount heatsinks for solid state relays

Types	RHS16225LD	RHS11267D	RHS30040D
			
Dimensions HxWxD (mm) (SSR not included)	162 x 250 x 25	112 x 125 x 67	300 x 200 x 40
Description	Heatsink for 1x 3-phase RZ3 series, max. 3x 1-phase RA, RD, RM, RAM, RS, RK and RG series	Heatsink for max. 3x 1-phase RG series or 1x 1-phase RA, RD, RM, RAM, RS and RK series	Heatsink for max. 12x 1-phase RG series or 8x 1-phase RA, RD, RM, RAM, RS and RK series
Thermal resistance**			
Without fan	0.84°C/W (>120 W)	0.54°C/W (>150 W)	0.40°C/W (>180 W)
With fan	Not available	Not available	Not available
Selection guide for heatsink assemblies*			
Without fan	R...H55L	R...H78	R...H57
With fan	Not available	Not available	Not available

Panel mount heatsinks for solid state relays

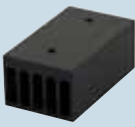
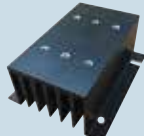
Types	RHS5050..	RHS38A..	RHS5840D
			
Dimensions HxWxD (mm) (SSR not included)	80 x 50 x 51	46 x 76 x 33	81 x 100 x 40
Description	RHS5050D: Heatsink for 1x 1-phase RA, RD, RM, RAM, RS and RK series RHS5050RFD: Heatsink for 1x 1-phase RF series	RHS38AD: Heatsink for 1x 1-phase RA, RD, RM, RAM, RS and RK series RHS38ARFD: Heatsink for 1x 1-phase RF series	Heatsink for max. 3x 1-phase RG series, 1x 1-phase RA, RD, RM, RAM, RS and RK series
Thermal resistance**			
Without fan	3.50°C/W (>25 W)	2.85°C/W (>40 W)	1.80°C/W (>60 W)
With fan	Not available	Not available	Not available
Selection guide for heatsink assemblies*			
Without fan	R...H60	R...H53	R...H48
With fan	Not available	Not available	Not available

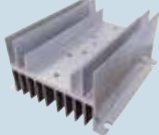
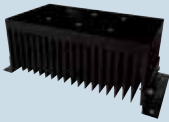
Types	RHS10067D	RHS10067LD	RHS320
			
Dimensions HxWxD (mm) (SSR not included)	121 x 76 x 67	121 x 140 x 67	240 x 100 x 93
Description	Heatsink for 1x 1-phase RA, RD, RM, RAM, RS and RK series	Heatsink for 2x 1-phase RA, RD, RM, RAM, RS, RK and RG series	Heatsink for 1x 3-phase RZ3 series, max. 3x 1-phase RA, RD, RM, RAM, RS, RK and RG series
Thermal resistance**			
Without fan	1.70°C/W (>20 W)	0.88°C/W (>80 W)	0.40°C/W (>120 W)
With fan	Not available	Not available	Not available
Selection guide for heatsink assemblies*			
Without fan	R...H58	R...H58L	R...H13
With fan	Not available	Not available	Not available

* Conditions may apply. Please ask your Sales representative for further details.

** Refer to specific heatsink datasheet for further details on heatsink characteristics and assemblies.

Soft starters

Scroll compressor soft starters

Types

RSBS

RSBD 45 & 75 mm

RSBT 45 & 120 mm

Soft starting of 1-Phase (RSBS) and 3-Phase (RSBD, RSBT) scroll compressors



Dimensions (mm)

60.4* x 137 x 81.4

12 A to 45 A:
106 x 45 x 125
55 A to 95 A:
150 x 75 x 170

16 A to 32 A (no relay output):
81 x 45 x 125
16 A to 32 A (with relay output):
97.5 x 45 x 125
55A to 95A:
150 x 120 x 170

Features

Internally bypassed, current limit start optional auxiliary relay output (Option V22), HP algorithm for high pressure starts

Compact 2- (RSBD) controlled soft starter for scroll compressors. Patented auto-adapt function for reduction of inrush current and for current balancing. No user settings required with HP algorithm optimised for multi-compressor systems

3-phase (RSBT) Controlled solution with internal bypass. Patented self-learning algorithm for optimal current reduction. Compliant to Class B (residential limits) for EMC emissions (16 A to 32 A). Optional serial communication for energy variables, alarms, start/stop.

Control specifications

Control input range

230 VAC

Option E: 110 - 400 VAC
Option F: 24 VAC / DC

Option E: 110 - 400VAC [RSBT 45 mm]
Option C: 24 VAC/DC & 110-400 VAC [RSBT 120 mm]

Controlled phases

1

2

3

Output specifications

Rated operational current (Ie)

RSBS2325...: 25 A
RSBS2332...: 32 A

RSBD 45 mm: 12/16/25/32/37/45A
RSBD 75 mm: 55/70/95 A

RSBT 45 mm: 16/25/32A
RSBT 120 mm: 55/70/95A

Operational voltage

230 VAC (-15%, +10%)

RSBD 45 mm: 220 - 400 VAC (-15%, +10%)
RSBD 75 mm: 220 - 600 VAC (-15%, +10%)

RSBT 45 mm: 220/400 VAC (-15%, +10%)
RSBT 120 mm: 220 - 480 VAC (-15%, +10%)

Number of starts per hour

12 (evenly distributed)

12 (evenly distributed)

12 (evenly distributed)

Assigned compressor rating @400 V

RSBS2325... / RSBS2332...****
3.7 kW (5 HP) / 4 kW (5 HP)

RSBD 45 mm:
5.5 kW (5 HP) to 22 kW (25 HP)
RSBD 75 mm:
30 kW (30 HP) to 55 kW (50 HP)

RSBT 45 mm:
7.5 kW (7.5 HP) to 15 kW (15 HP)
RSBT 120 mm:
22 kW (30 HP) to 45 kW (50 HP)

General specifications

Internally bypassed

Yes

Yes

Yes

Operational frequency

50/60 Hz ±10%

50/60 Hz +/- 10 Hz

50/60 Hz +/- 10 Hz

Ramp up/Ramp down

< 600ms/0s

<1s/0s

<1s/0s

Default Current limit

RSBS2325...V.2...: 40 Arms
RSBS2332...V.2...: 45 Arms

3.5xIe

RSBT 45 mm
RSBT..16: 40 A,
RSBT..25: 90 A,
RSBT..32: 110 A
RSBT 120 mm: 3.5xIe

Operating temperature

-20°C to +65°C (-4°F to +149°F)

-20°C to +60°C (-4°F to +140°F)

RSBT..16: -20°C to 60°C (-4°F to +140°F)
RSBT..25: -20°C to 55°C (-4°F to +131°F)
RSBT..32: -20°C to 50°C (-4°F to +122°F)

Storage temperature

-30°C to +70°C (-22°F to +158°F)

-40°C to +80°C (-40°F to +176°F)

-40°C to +85°C (-40°F to +185°F)

Wrong phase sequence indication

N/A

Yes

Yes

Degree of protection

IP 20

RSBD 45 mm: IP20
RSBD 75 mm: IP 20 (Housing) / IP 10 (Terminals)

RSBT 45 mm: IP20
RSBT 120 mm: IP 20 (Housing) / IP 10 (Terminals)

Approvals

CE - UL - cUL

RSBD 45 mm: CE - cULus - CCC
RSBD 75 mm: CE - cULus - CCC

RSBT 45 mm: CE - cULus** - VDE*** - CCC
RSBT 120 mm: CE - cULus

* For RSBS23...V22... auxiliary terminal is 10.5 mm protruding

** For options V50/ V51/ V61

*** Up to 15 AAC (Up to 32 AAC for RSBT..HPV models only)

**** Assigned compressor rating @ 230 V

Soft starters

Centrifugal pump soft starters

Types	RSWT 45 mm	RSWT 75 & 120 mm
Soft-starters with dedicated, self-learning algorithm for centrifugal pumps.		
Dimensions (mm)	RSWT4012/RSWT4016: 130 x 45 x 125 RSWT4025: 157 x 45 x 125	RSWT 75 mm: 177 x 75 x 206 RSWT 120 mm: 177 x 120 x 206
Features	3-phase controlled, internally bypassed. Self-learning algorithm dedicated to centrifugal pumps. RSWT.V00 version - 1-knob adjustment for ramp-up and ramp-down. RSWT.V10 version - Integrated overload protection (Class 10). RSWT40 versions - internally supplied.	3-phase controlled and internally bypassed. RSWT.V01. versions with PTC input protection. RSWT...V11.versions with integrated overload protection, PTC i/p, remote alarm reset. RSWT40 versions - internally supplied. 3 output relays for alarm, top of ramp and run indication.

Control specifications

Control input range	Option E: 110 - 400 VAC Option F: 24 VAC/DC Option G: 100 - 240 VAC [RSWT60..]	Option E: 110 - 400 VAC [RSWT40..] Option F: 24 VAC/DC [RSWT40....] Option G: 100 - 240 VAC [RSWT60..]
Controlled phases	3	3

Output specifications

Rated operational current AC 53b	12/16/25 A	32/37/45/55/70/90 A
Operational voltage	RSWT40: 220 - 400 VAC (-15%, +10%) RSWT60: 220 - 600 VAC (-15%, +10%)	RSWT40: 220 - 400 VAC (-15%, +10%) RSWT60: 220 - 600 VAC (-15%, +10%)
Number of starts per hour @40°C	20	20
Assigned motor rating @ 400 V	RSWTxx12: 5.5 kW (5 HP) RSWTxx16: 7.5 kW (7.5 HP) RSWTxx25: 11 kW (10 HP)	RSWTxx32: 15 kW (20 HP) RSWTxx37: 18.5 kW (25 HP) RSWTxx45: 22 kW (30 HP) RSWTxx55: 25 kW (35 HP) RSWTxx70: 37 kW (40 HP) RSWTxx90: 45 kW (50 HP)



General specifications

Internally bypassed	Yes	Yes
Operational frequency	50/60 Hz +/- 10%	50/60 Hz +/- 10%
Ramp up/Ramp down	RSWT40...V00: 1 - 20s RSWTxx...V10: 1-20s/0-20s	RSWT40...V010/V011: 1 - 20s RSWTxx...V110/V111: 1-20s/0-20s
Initial torque	Self-adjusted by RSWT	Self-adjusted by RSWT
Operating temperature	-20°C to 60°C (-4°F to +140°F)	-20°C to 60°C (-4°F to +140°F)
Storage temperature	-40°C to +80°C (-40°F to +176°F)	-40°C to +80°C (-40°F to +176°F)
Integrated overload protection	RSWT40...V00: No RSWTxx...V10: Yes	RSWT40...V010/V011: No RSWTxx...V110/V111: Yes
Degree of protection	IP 20	IP 20 (control circuit) IP 10 (power terminals)
Approvals	CE - cULus - CCC	CE - cULus - CCC

xx = 40 or 60

Soft starters

Motor control - Soft start and stop

Types	RSHR 3-Phase	RSGD 45mm	RSGD 75mm
Soft starting and stopping of 3-phase motors. Starting / stopping time and initial torque can be independently adjusted			
Dimensions (mm)	158.5 x 90 x 90	106 x 45 x 125 [RSGD..12.. - RSGD..32..] 150 x 45 x 132 [RSGD..37.. - RSGD..45..]	177 x 75 x 206 [RSGD..55.. - RSGD..85..] 177 x 75 x 221 [RSGD..100..]
Features	3-phase controlled. In Line or In Delta (6-wire) connection. Wrong Phase sequence detection. Motor PTC protection. Phase Loss Detection	Compact 2-phase controlled general purpose soft starter. Self-learning algorithm for better current balancing. Improved current reduction capability. Optional alarm and top of ramp relay output	Self-learning 2-phase controlled general purpose soft starter. Intergrated motor overload protection (Class 10) and serial communication (Modbus RS485)

Control specifications

Control input range	24-550 VAC/DC (Option "C") 24-600 VAC/DC (Option "D")	Option E0: 110 - 400 VAC [RSGD40..] Option OF: 24 VAC/DC [RSGD40..] Option GG: 100 - 240 VAC [RSGD60..]	Option E0: 110 - 400 VAC [RSGD40..] Option FO: 24 VAC/DC [RSGD40..] Option FF: 24VAC/DC [RSGD60..] Option GG: 100 - 240 VAC [RSGD60..]
Controlled phases	3	2	2



Output specifications

Rated operational current AC 53b	25 A [RSHR..25...] 32 A [RSHR..32...]	12/16/25/32/37/45 A	55/70/85/100
Operational voltage	127/220 VAC [RSHR22..] 230/400 VAC [RSHR40..] 277/480 VAC [RSHR48..] 346/600 VAC [RSHR60..] 220-480 VAC [RSHRM] 400-480 VAC [RSHRM]	RSGD40: 220 - 400 VAC (-15%, +10%) RSGD60: 220 - 600 VAC (-15%, +10%)	RSGD40: 220 - 400 VAC (-15%, +10%) RSGD60: 220 - 600 VAC (-15%, +10%)
Number of starts per hour @40°C	7 [RSHR2225.../RSHR4025...] 3 [RSHR4825.../RSHR6025.../RSHRM] 50 [RSHR..32...]	20: [RSGD..12/RSGD..16/RSGD..25] 10: [RSGD..32/RSGD..37/RSGD..45]	10
Assigned motor rating @ 400 V	In Line Connection/In Delta Connection RSHR4025CV.. 11 kW [10 HP] / 20 kW [20 HP] RSHR4032CV.. 15 kW [20 HP] / 22kW [30 HP]	RSGDxx12/RSGDxx16/RSGDxx25 3 kW (3 HP) / 4 kW (5 HP) / 5.5 kW (7.5 HP) 5.5 kW (5.0 HP) / 7.5 kW (7.5 HP) / 11 kW (10 HP) RSGDxx32/RSGDxx37/RSGDxx45 9 kW (10 HP) / 9 kW (10 HP) / 11 kW (15 HP) 15 kW (15 HP) / 18.5 kW (20 HP) / 22 kW (25 HP)	RSGD..55: 30kW/30HP RSGD..70: 37kW/40HP RSGD..85: 45kW/50HP RSGD..100:55kW/50HP

General specifications

Internally bypassed	No	Yes	Yes
Operational frequency	50/60 Hz ±10%	50/60 Hz ± 10%	50/60 Hz ± 2 Hz
Ramp up/Ramp down	1-10s / 0-30s; 0-1s / 0-1s [RSHR...V38]	1 - 20s/0 - 20s	1 - 30s/0 - 30s
Initial torque	0-70%	0 - 85%	Not required
Operating temperature	-20°C to +60°C (-4°F to +140°F)	-20°C to 60°C (-4°F to +140°F)	-20°C to 60°C (-4°F to +140°F)
Storage temperature	-50°C to +85°C (-58°F to +185°F)	-40°C to +80°C (-40°F to +176°F)	-40°C to +80°C (-40°F to +176°F)
Wrong phase sequence indication	Yes	Yes	Yes
Degree of protection	IP 20	IP 20	IP 20 (control circuit) IP 10 (power terminals)
Approvals	CE - UL - cUL - CCC	CE - cULus - CCC	CE - cULus - CCC

Soft starters

	Proportional controller	Motor reversing
Types	RSC..AA..+RSO...	RR2A
Phase angle control of 3-phase motors (AC53a) and heaters (AC51a). Reversing motor relay (RR..)		
Dimensions (mm)	65 x 103 x 74	41 x 103 x 74
Features	Proportional output for motor/heater control according to user controlled analogue input	Reversing with interlock, optoisolation 2-pole change-over, built-in transient overvoltage protection, interlocking reversing, LED status indication
Control specifications		
Control input range	0-20 mA (A-input) 4-20 mA (B-input)	10-40 VDC
Max. input current	20 mA	20 mA
Control supply	10 - 32 VDC	-
Max. supply current	180 mA	-
Output specifications		
Rated operational current		
AC 51a	16 Arms [RSO..10] 25 Arms [RSO..25] 50 Arms [RSO..50] 90 Arms [RSO..90] 110 Arms [RSO..110]	-
AC 53a	5 Arms [RSO..25] 15 Arms [RSO..50] 30 Arms [RSO..90] 40 Arms [RSO..110]	5 Arms [RR2A40D150/RR2A48D220] 11 Arms [RR2A40D400/RR2A48D550]
Operational voltage	150-250 Vrms [RSO22..] 220-420 Vrms [RSO40..] 400-510 Vrms [RSO48..] 400-625 Vrms [RSO60..]	400 Vrms [RR2A40D...] 480 Vrms [RR2A48D...]
General specifications		
Connections	Screw type with clamp	Screw type with clamp
Operating temperature	-20°C to +70°C	-20°C to +80°C
Storage temperature	-40°C to +100°C	-40°C to +100°C
Approvals/Marks	CE - UL - CSA - CCC	CE - UL - cUL - CCC
Reference		
	Control module	5 A
	RSC-AAM60	RR2A40D150 (1.5 kW)
	Output module: 400 VAC	RR2A40D400 (4.0 kW)
	25 A: RSO4025 (4 kW*)	11 A
	50 A: RSO4050 (11 kW*)	RR2A48D220 (2.2 kW)
	90 A: RSO4090 (15 kW*)	RR2A48D550 (5.5 kW)
	110 A: RSO40110 (22 kW*)	





* Output module can be 200, 400, 480, 600 VAC

* Correct heatsink assembly required. For further details please consult datasheet.

** Applicable when device is mounted to heatsink type RHS301





Motor protection relays

DMPU series

Types	Main module	Measurement module (5 A)	Measurement module (65 A)	I/O module
				
Dimensions HxWxD (mm)	35.5 x 90 x 63.2	53.5 x 90 x 63.2	53.5 x 90 x 92	17.5 x 90 x 63.2
Features	Motor start/stop, reverse, start/delta, ANSI motor protection functions, remote control and management, warning, dataloggers	3-phase voltage and split-core current measurement	3-phase voltage and pass through current measurement	Connected to DMPUC-PRB or DMPUC-MBT adds 2 inputs and 2 outputs to the system. Up to 10 modules can be used
Technical specifications				
Power supply	24 VDC ±20%	24 VDC from the main module	24 VDC from the main module	24 VDC from the main module
Inputs	3, configurable as contact or temperature	3-phase voltage: 100 to 690 V 3-phase current: 5 A (for higher current use CTD currents transformers series)	3-phase voltage: 100 to 690 V 3-phase current: up to 65 A	2, configurable as contact or temperature
Outputs		2 x SPST relay	2 x SPST relay	2 x SPST relay
Communication	Profibus DPV1 (DMPUC-PRB), Modbus TCP/IP (DMPUC-MBT), Modbus RTU (all)	Via cable to the main module	Via cable to the main module	Plugged in to the main module
General specifications				
Operating temperature	-25°C to +55°C (-13°F to 131°F)	-25°C to +55°C (-13°F to 131°F)	-25°C to +55°C (-13°F to 131°F)	-25°C to +55°C (-13°F to 131°F)
Degree of protection	IP 20	IP 20	IP 20	IP 20
Mounting	DIN-rail	DIN-rail	DIN-rail	DIN-rail
Approvals	CE - cULus listed - C-TIC	CE - cULus listed - C-TIC	CE, cULus listed, C-TIC	CE - cULus listed - C-TIC
References				
	DMPUC-PRB DMPUC-MBT	DMPUC-05	DMPUC-65	DMPUC-R2

Motor protection relays



DMPU series

Types	Operator interface	Earth leakage module	Core balance transformers	Programming software
				
Dimensions HxWxD (mm)	96 x 48 x 88.5	17.5 x 90 x 63.2	Hole Ø 35, 70, 120 or 210	
Features	Provides 2x8 characters lines display and 4 fully programmable keys	Connected to DMPUC-PRB or DMPUC-MBT adds direct earth leakage measurement and protection according to EN 60947-2. Ranges: 30 mA to 30 A	Core balance transformers for DMPUC-EL	Set parameters, program the control and monitoring functions of the system, monitor data, download dataloggers. Program operator interface pages and key functions
Technical specifications				
Power supply	24 VDC ±20%	24 VDC from the main module	None	
Inputs		Earth leakage, for transformers 250/1 to 1000/1, 3 as contact		Motor data, desired functions
Outputs		1 x SPST relay dedicated to earth leakage alarm		Configuration file, dataloggers in Excel format files
Communication	RS485 Modbus RTU ports	Plugged in to the main module		Using Modbus RTU or TCP/IP port of the main module
General specifications				
Operating temperature	-25°C to +60°C (-13°F to 140°F)	-25°C to +55°C (-13°F to 131°F)		
Degree of protection	Front: IP 65 Connections: IP 20	IP 20		
Mounting	Front panel	DIN-rail	Back panel	Windows XP, Windows Vista, Windows 7
Approvals	cULus listed	CE - cULus - C-TIC (with CTG)	CE - cULus - C-TIC (with DMPUC-EL)	
References				
	DMPUC-HMI	DMPUC-EL	CTG035 CTG070 CTG120 CTG210	DMPU-PS DMPU-PSHMI

Variable frequency drives

VariFlex³ variable frequency drives - RVL series

Accessories

Types	Size A	Size B	Braking unit
Drives, Inverters			
Dimensions HxWxD (mm)	141 x 72 x 139	144 x 118 x 147	132 x 77 x 130.5
Features	V/F control Soft PWM. 3 modes selectable, 32 bit Processor, 150% torque at 3 Hz, RJ45 Interface, built-in EMI filter, Parameter Lock & Parameter access code, Auto sequencer 8 programmable presets for frequency & run duration, Individual Accel/decel for auto sequencer preset speeds, Five Multi function Inputs, Output relay programmable NO or NC	V/F control Soft PWM. 3 modes selectable, 32 bit Processor, 150% torque at 3 Hz, RJ45 Interface, built-in EMI filter, Parameter Lock & Parameter access code, Auto sequencer 8 programmable presets for frequency & run duration, Individual Accel/decel for auto sequencer preset speeds, Five Multi function Inputs, Output relay programmable NO or NC	External braking unit for RVEF frequency drives, with 240 VAC and 480 VAC inverter voltage. Applicable motor rated capacity up to 2.2 kW
Technical specifications			
AC supply voltage	1-ph: 200-240 VAC; 3-ph: 380-480 VAC;	1-ph: 200-240 VAC; 3-ph: 380-480 VAC;	
AC supply frequency	50/60 Hz	50/60 Hz	
Output voltage	3-ph: 0-240 VAC [RVLFA120...] 3-ph: 0-480 VAC [RVLFA340...]	3-ph: 0-240 VAC [RVLFB120...] 3-ph: 0-480 VAC [RVLFB340...]	
Output frequency	0.01~650.00 Hz	0.01~650.00 Hz	
100% RMS output current	1.8 A [RVLFA...020F] 2.6 A [RVLFA...040F] 4.3 A [RVLFA...075F]	7.5 A [RVLFB120150F] 10.5 A [RVLFB120220F] 4.3 A [RVLFB340075F] 7.5 A [RVLFB340150F] 10.5 A [RVLFB340220F]	
Input displacement factor (cos φ)	> 0.97	> 0.97	
General specifications			
Operating temperature	-10°C to +50°C	-10°C to +50°C	-10°C to +50°C
Storage temperature	-20°C to +60°C	-20°C to +60°C	-20°C to +70°C
Degree of protection	IP 20	IP 20	IP 20
Power connections	Screw terminals	Screw terminals	
Control connections	Screw terminals	Screw terminals	
Drive connections			Screw terminals
Mounting	DIN-rail or panel mounting	DIN-rail or panel mounting	DIN-rail or panel mounting
Integrated cooling fan	No	Yes (1,5-2,2 kW)	
Switching frequency	1 to 16 kHz	1 to 16 kHz	
Approvals	CE - cULus	CE - cULus	CE - cULus
Braking unit			
Rate discharge current		240 V: 7.5 A	480 V: 3 A
Max. discharge current		240 V: 15 A	480 V: 7.5 A
References			
200 - 240 VAC, 1-phase	RVLFA120020F (0.20 kW - 0.25 HP) RVLFA120040F (0.40 kW - 0.50 HP) RVLFA120075F (0.75 kW - 1.00 HP)	RVLFB120150F (1.50 kW - 2.00 HP) RVLFB120220F (2.20 kW - 3.00 HP)	RVFTBU230
380 - 480 VAC, 3-phase		RVLFB340075F (0.75 kW - 1.00 HP) RVLFB340150F (1.50 kW - 2.00 HP) RVLFB340220F (2.20 kW - 3.00 HP)	RVFTBU480

Variable frequency drives

VariFlex³ variable frequency drives - RVFF series

Types	Size A	Size B	Size C
Drives, Inverters			

Dimensions HxWxD (mm)	385 x 140 x 177	416 x 210 x 215	500 x 265 x 225
-----------------------	-----------------	-----------------	-----------------

Features	V/F control, SLV, PM SLV with PWM mode, 32bit processor, overload 120% for 60sec, built-in filter (up to 55kw), simple PLC capability, 2 sets of PID functions, multi-pumps control, 6 multi-functions DI, 3 multi-functions D O, 2 Analogue inputs and 2 Analogue outputs, built-in RS485 modbus communication.		
----------	--	--	--

Technical specifications

AC supply voltage	3-ph: 380-480 VAC	3-ph: 380-480 VAC	3-ph: 380-480 VAC
AC supply frequency	50/60 Hz	50/60 Hz	50/60 Hz
Output voltage	3-ph: 380-480 VAC	3-ph: 380-480 VAC	3-ph: 380-480 VAC
Output frequency	0.1 ~ 400.0 Hz	0.1 ~ 400.0 Hz	0.1 ~ 400.0 Hz
100% RMS output current	9.2 A [RVFFA3400400F] 12.1 A [RVFFA3400550F] 17.5 A [RVFFA3400750F]	23 A [RVFFB3401100F] 31 A [RVFFB3401500F]	38 A [RVFFC3401850F] 44 A [RVFFC3402200F] 54 A [RVFFC3403000F]

General specifications



Operating temperature	-10°C to +50°C	-10°C to +50°C	-10°C to +50°C
Storage temperature	-20°C to +70°C	-20°C to +70°C	-20°C to +70°C
Degree of protection	IP 20	IP 20	IP 20
Power connections	Screw terminals	Screw terminals	Screw terminals
Control connections	Screw terminals	Screw terminals	Screw terminals
Drive connections	Screw terminals	Screw terminals	Screw terminals
Mounting	Panel mounting	Panel mounting	Panel mounting
Integrated cooling fan	Yes	Yes	Yes
Switching frequency	2 to 16 kHz	2 to 16 kHz	2 to 16 kHz
Approvals	CE - cULus	CE - cULus	CE - cULus

References

380 - 480 VAC, 3-phase	RVFFA3400400F (4 kW - 5 HP) RVFFA3400400F (5.5 kW - 7.5 HP) RVFFA3400750F (7.5 kW - 10 HP)	RVFFB3401100F (11 kW - 15 HP) RVFFB3401500F (15 kW - 20 HP)	RVFFC3401850F (18.5 kW - 25 HP) RVFFC3402200F (22 kW - 30 HP) RVFFC3403000F (30 kW - 40 HP)
------------------------	---	--	--

Variable frequency drives

VariFlex³ variable frequency drives - RVFF series

Types	Size D	Size E	Size F
Drives, Inverters			
Dimensions HxWxD (mm)	679 x 284 x 252	740 x 349 x 300	1105 x 463 x 325
Features	V/F control, SLV, PM SLV with PWM mode, 32bit processor, overload 120% for 60sec, built-in filter (up to 55kw), simple PLC capability, 2 sets of PID functions, multi-pumps control, 6 multi-functions DI, 3 multi-functions D O, 2 Analogue inputs and 2 Analogue outputs, built-in RS485 modbus communication.		
Technical specifications			
AC supply voltage	3-ph: 380-480 VAC;	3-ph: 380-480 VAC;	3-ph: 380-480 VAC;
AC supply frequency	50/60 Hz	50/60 Hz	50/60 Hz
Output voltage	3-ph: 380-480 VAC	3-ph: 380-480 VAC	3-ph: 380-480 VAC
Output frequency	0.1 ~ 400.0 Hz	0.1 ~ 400.0 Hz	0.1 ~ 400.0 Hz
100% RMS output current	73 A [RVFFD3403700F] 88 A [RVFFD3404500F] 103 A [RVFFD3405500F]	145 A [RVFFE3407500] 168 A [RVFFE3409000]	208 A [RVFFF34011000] 250 A [RVFFF34013200] 296 A [RVFFF34016000]
General specifications			
Operating temperature	-10°C to +50°C	-10°C to +50°C	-10°C to +50°C
Storage temperature	-20°C to +70°C	-20°C to +70°C	-20°C to +70°C
Degree of protection	IP 20	IP 20	IP 20
Power connections	Screw terminals	Screw terminals	Screw terminals
Control connections	Screw terminals	Screw terminals	Screw terminals
Drive connections	Screw terminals	Screw terminals	Screw terminals
Mounting	Panel mounting	Panel mounting	Panel mounting
Integrated cooling fan	Yes	Yes	Yes
Switching frequency	2 to 16 kHz	2 to 16 kHz	2 to 16 kHz
Approvals	CE - cULus	CE - cULus	CE - cULus
References			
380 - 480 VAC, 3-phase	RVFFD3403700F (37 kW - 50 HP) RVFFD3404500F (45 kW - 60 HP) RVFFD3405500F (55 kW - 75 HP)	RVFFE3407500 (75 kW - 100 HP) RVFFE3409000 (90 kW - 125 HP)	RVFFF34011000 (110 kW - 150 HP) RVFFF34013200 (132 kW - 175 HP) RVFFF34016000 (160 kW - 215 HP)

Limit switches - Safety hinge

Head types

Safety hinge

Safety hinge

Safety hinge



Family: PS38H

	PS38H M12 connector	PS38H 2 m cable	PS38H 2 m cable back output
Material body	Thermoplastic	Thermoplastic	Thermoplastic
Dimensions WxHxD (mm)	60 x 110 x 15	60 x 110 x 15	60 x 110 x 15

References contact block

Slow action T22: 2NO + 2NC	PS38H-IT2205-T01	PS38H-CT2205-T01	PS38H-CT2205-T02
Slow action T13: 1NO + 3NC	PS38H-IT1305-T01	PS38H-CT1305-T01	PS38H-CT1305-T02

General specifications (for all types)

Conformance	IEC 947-5-1 and European EN 60947-5-1 standards. Safety system of machinery up to SIL 3 or PLe according to EN ISO 13849-1.	IEC 947-5-1 and European EN 60947-5-1 standards. Safety system of machinery up to SIL 3 or PLe according to EN ISO 13849-1.	IEC 947-5-1 and European EN 60947-5-1 standards. Safety system of machinery up to SIL 3 or PLe according to EN ISO 13849-1.
Air temperature near the device	Operation - 20°C to + 80°C Storage - 20°C to + 80°C	Operation - 20°C to + 80°C Storage - 20°C to + 80°C	Operation - 20°C to + 80°C Storage - 20°C to + 80°C
Degree of protection	IP 67	IP 67	IP 67
Mechanical durability	1,000,000 operations	1,000,000 operations	1,000,000 operations
Operation frequency	1,200 cycles/h	1,200 cycles/h	1,200 cycles/h
B10d	2,000,000 cycles	2,000,000 cycles	2,000,000 cycles
Positive opening operation (according to IEC 947-5-1)	All NC contacts are positive opening operation (min. actuating torque 0.5 Nm)	All NC contacts are positive opening operation (min. actuating torque 0.5 Nm)	All NC contacts are positive opening operation (min. actuating torque 0.5 Nm)
Rated insulation voltage Ui	30 V	400 V	400 V
Protection against electrical shocks (according to IEC 536)	Class II	Class II	Class II
Thermal current Ith	2 A	4 A	4 A
Rated operational current	24 VDC - 2 A	24 - 120 - 250 - 400 VCA 4 A 24 VDC 2 A / 125 VDC 0.4 A / 250 VDC 0.3 A	24 - 120 - 250 - 400 VAC 4 A 24 VDC 2 A / 125 VDC 0.4 A / 250 VDC 0.3 A
Approvals	CE - UL - CSA	CE - UL - CSA	CE - UL - CSA

Limit switches - Miniature type

Head Types	PO Plain plunger	PY Nylon roller plunger	P8 Cross nylon roller plunger	RT Ø14 Nylon roller lever
------------	----------------------------	-----------------------------------	---	-------------------------------------

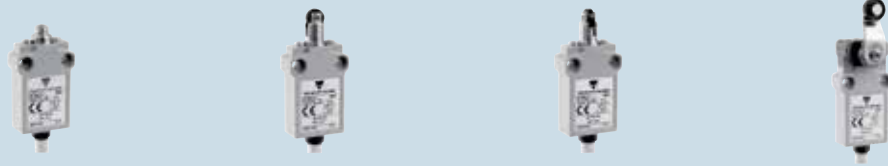

Dimensions HxWxD (mm)	35 x 60 x 16 1 m PVC cable	35 x 70 x 16 1 m PVC cable	35 x 70 x 16 1 m PVC cable	35 x 92 x 29.5 1 m PVC cable
-----------------------	-------------------------------	-------------------------------	-------------------------------	---------------------------------

PS31M (metal*) References contact block

Snap 1NO+1NC	⊕	PS31M-CS11PO-M00	PS31M-CS11PY-M00	PS31M-CS11P8-M00	PS31M-CS11RT-M00
Slow 1NO+1NC	⊕	PS31M-CT11PO-M00	PS31M-CT11PY-M00	PS31M-CT11P8-M00	PS31M-CT11RT-M00

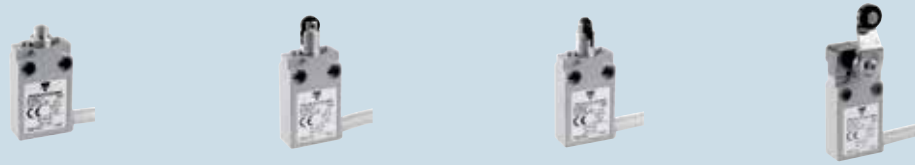

Dimensions WxHxD (mm)	31.5 x 60 x 16 1 m PVC cable	31.5 x 70 x 16 1 m PVC cable	31.5 x 70 x 16 1 m PVC cable	31.5 x 92 x 29.5 1 m PVC cable
-----------------------	---------------------------------	---------------------------------	---------------------------------	-----------------------------------

PS21M (metal*) References contact block

Snap 1NO+1NC	⊕	PS21M-CS11PO-M00	PS21M-CS11PY-M00	PS21M-CS11P8-M00	PS21M-CS11RT-M00
Slow 1NO+1NC	⊕	PS21M-CT11PO-M00	PS21M-CT11PY-M00	PS21M-CT11P8-M00	PS21M-CT11RT-M00

Head Types	Plain plunger with fixing nuts	Roller plunger with fixing nuts	Cross roller plunger with fixing nuts	R1 Adjustable lever with Ø18 nylon roller
------------	-----------------------------------	------------------------------------	--	---

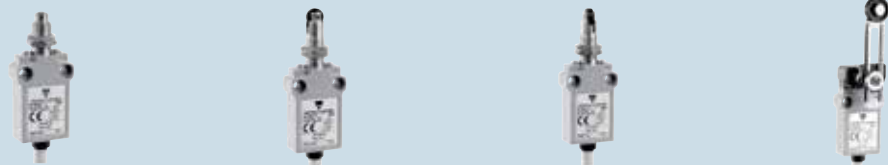

Dimensions (mm) WxHxD	35 x 74 x 16 1 m PVC cable	35 x 84.8 x 16 1 m PVC cable	35 x 84.8 x 16 1 m PVC cable	35 x 86...158 x 38.9 1 m PVC cable
-----------------------	-------------------------------	---------------------------------	---------------------------------	---------------------------------------

PS31M (metal*) References contact block

Snap 1NO+1NC	⊕	PS31M-CS11PO-MOL	PS31M-CS11PY-MOL	PS31M-CS11P8-MOL	PS31M-CS11RT-MOL
Slow 1NO+1NC	⊕	PS31M-CT11PO-MOL	PS31M-CT11PY-MOL	PS31M-CT11P8-MOL	PS31M-CT11RT-MOL

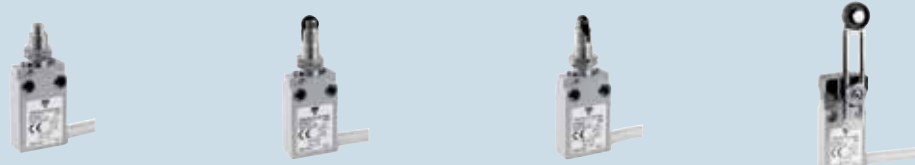

Dimensions WxHxD (mm)	31.5 x 74 x 16 1 m PVC cable	31.5 x 84.8 x 16 1 m PVC cable	31.5 x 84.8 x 16 1 m PVC cable	31.5 x 86...158 x 38.9 1 m PVC cable
-----------------------	---------------------------------	-----------------------------------	-----------------------------------	---

PS21M (metal*) References contact block

Snap 1NO+1NC	⊕	PS21M-CS11PO-MOL	PS21M-CS11PY-MOL	PS21M-CS11P8-MOL	PS21M-CS11RT-MOL
Slow 1NO+1NC	⊕	PS21M-CT11PO-MOL	PS21M-CT11PY-MOL	PS21M-CT11P8-MOL	PS21M-CT11RT-MOL

General specifications (for all types)

Mechanical life	>10 000 000 cycles	Rated thermal current (Ith)	10 A (IEC947-5-1)
Operating frequency	3600 cycles/h	Rated insulation voltage (Ui)	400 VAC (IEC947-5-1)
Operating Speed	1...1500 mm/s	Insulation resistance (500 VDC)	2 MΩ
Rated operating current (Ie)	1.5 A/230 V (Cat. AC15)	Degree of protection	IP 67
	1.1 A/24 V (Cat. DC13)	Approvals	CE - UL (upon request)

* Also available in thermoplastic (T type)

Limit switches - Limit type

Head Types	PO Plain plunger	PR Roller plunger	RH Plastic roller plunger	RT Nylon roller lever
------------	----------------------------	-----------------------------	-------------------------------------	---------------------------------

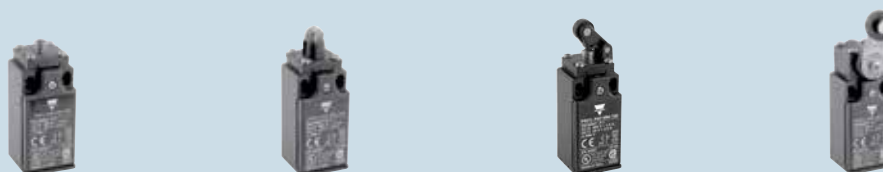

Family: L

	PS21 Thermoplastic*	PS21 Thermoplastic*	PS21 Thermoplastic*	PS21 Thermoplastic*
Dimensions WxHxD (mm)	30.3 x 73 x 30	30.3 x 84 x 30	30.3 x 92 x 30	30.3 x 106 x 45

References contact block

Snap 1NO+1NC	⊕	PS21L-PS11P0-T00	PS21L-PS11PR-T00	PS21L-PS11RH-T00	PS21L-PS11RT-T00
Slow 1NO+1NC	⊕	PS21L-PT11P0-T00	PS21L-PT11PR-T00	PS21L-PT11RH-T00	PS21L-PT11RT-T00
Slow Ov.**1NO+1NC	⊕	PS21L-PO11P0-T00	PS21L-PO11PR-T00	PS21L-PO11RH-T00	PS21L-PO11RT-T00
Slow 2NO		PS21L-PT20P0-T00	PS21L-PT20PR-T00	PS21L-PT20RH-T00	PS21L-PT20RT-T00
Slow 2NC	⊕	PS21L-PT02P0-T00	PS21L-PT02PR-T00	PS21L-PT02RH-T00	PS21L-PT02RT-T00
Snap 2NC	⊕	PS21L-PS02P0-T00	PS21L-PS02PR-T00	PS21L-PS02RH-T00	PS21L-PS02RT-T00

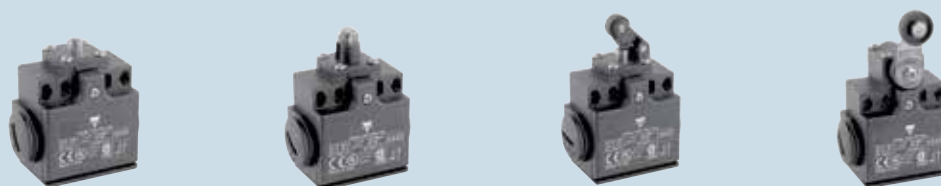

Family: L

	PS42 Thermoplastic*	PS42 Thermoplastic*	PS42 Thermoplastic*	PS42 Thermoplastic*
Dimensions HxWxD (mm)	57 x 66 x 33	57 x 77 x 33	57 x 85 x 33	57 x 99 x 45

References contact block

Snap 1NO+1NC	⊕	PS42L-PS11P0-T00	PS42L-PS11PR-T00	PS42L-PS11RH-T00	PS42L-PS11RT-T00
Slow 1NO+1NC	⊕	PS42L-PT11P0-T00	PS42L-PT11PR-T00	PS42L-PT11RH-T00	PS42L-PT11RT-T00
Slow Ov.**1NO+1NC	⊕	PS42L-PO11P0-T00	PS42L-PO11PR-T00	PS42L-PO11RH-T00	PS42L-PO11RT-T00
Slow 2NO		PS42L-PT20P0-T00	PS42L-PT20PR-T00	PS42L-PT20RH-T00	PS42L-PT20RT-T00
Slow 2NC	⊕	PS42L-PT02P0-T00	PS42L-PT02PR-T00	PS42L-PT02RH-T00	PS42L-PT02RT-T00
Snap 2NC	⊕	PS42L-PS02P0-T00	PS42L-PS02PR-T00	PS42L-PS02RH-T00	PS42L-PS02RT-T00

General specifications (for all types)

Degree of protection	IP 65 (plastic body) IP 66 (metal body)	Rated operational current	
Rated insulation voltage plastic body	(U _i)	le/AC-15 230 VAC	3.1 A
according to IEC 60947-1 and EN 60947-1	500 V	le/AC-13 24 VDC	2.8 V
according to UL 508, CSA C22-2 n°14	A 600, Q 600	Electrical durability (according to IEC 60947-5-1 annex C)	
Rated insulation voltage metal body	(U _i)	max. switching frequency Cycles/h	3600
according to IEC 60947-1 and EN 60947-1	400 V (PS21, PS42)	load factor	0.5
	500 V (PS31, PS43)	Air temperature near the device	
according to UL 508, CSA C22-2 n°14	A 300, Q 300 (PS21, PS42)	during operation	-25 to +70°C
	A 600, Q 600 (PS31, PS43)	for storage	-30 to +80°C
Conventional enclosed thermal voltage (U _{imp})	6 kV	Approvals	CE - UL - CSA

* also available in metal (Y type) ** Ov.: overlapping travel paths

Limit switches - Limit type

Head types

W1 Adjustable lever with Ø50 rubber roller

R1 Adjustable lever with Ø18 nylon roller

BE Ø18 nylon roller lever

LW Stainless steel spring cat whisker



Family: L

	PS21	PS21	PS21	PS21
	Thermoplastic*	Thermoplastic*	Thermoplastic*	Thermoplastic*
Dimensions WxHxD (mm)	30.3 x (126.5-186.5) x 52	30.3 x (98.5-170.5) x 45.5	30.3 x 114 x 33	30.3 x 188 x 30

References contact block

Snap 1NO+1NC	⊕	PS21L-PS11W1-T00	PS21L-PS11R1-T00	PS21L-PS11BE-T00	PS21L-PS11LW-T00
Slow 1NO+1NC	⊕	PS21L-PT11W1-T00	PS21L-PT11R1-T00	PS21L-PT11BE-T00	PS21L-PT11LW-T00
Slow Ov.**1NO+1NC	⊕	PS21L-PO11W1-T00	PS21L-PO11R1-T00	PS21L-PO11BE-T00	PS21L-PO11LW-T00
Slow 2NO		PS21L-PT20W1-T00	PS21L-PT20R1-T00	PS21L-PT20BE-T00	PS21L-PT20LW-T00
Slow 2NC	⊕	PS21L-PT02W1-T00	PS21L-PT02R1-T00	PS21L-PT02BE-T00	PS21L-PT02LW-T00
Snap 2NC	⊕	PS21L-PS02W1-T00	PS21L-PS02R1-T00	PS21L-PS02BE-T00	PS21L-PS02LW-T00



Family: L

	PS42	PS42	PS42	PS42
	Thermoplastic*	Thermoplastic*	Thermoplastic*	Thermoplastic*
Dimensions HxWxD (mm)	57 x (118.5-177) x 33	57 x (91.5-163.5) x 33	57 x 107 x 33	57 x 181 x 45

References contact block

Snap 1NO+1NC	⊕	PS42L-PS11W1-T00	PS42L-PS11R1-T00	PS42L-PS11BE-T00	PS42L-PS11LW-T00
Slow 1NO+1NC	⊕	PS42L-PT11W1-T00	PS42L-PT11R1-T00	PS42L-PT11BE-T00	PS42L-PT11LW-T00
Slow Ov.**1NO+1NC	⊕	PS42L-PO11W1-T00	PS42L-PO11R1-T00	PS42L-PO11BE-T00	PS42L-PO11LW-T00
Slow 2NO		PS42L-PT20W1-T00	PS42L-PT20R1-T00	PS42L-PT20BE-T00	PS42L-PT20LW-T00
Slow 2NC	⊕	PS42L-PT02W1-T00	PS42L-PT02R1-T00	PS42L-PT02BE-T00	PS42L-PT02LW-T00
Snap 2NC	⊕	PS42L-PS02W1-T00	PS42L-PS02R1-T00	PS42L-PS02BE-T00	PS42L-PS02LW-T00

General specifications (for all types)

Degree of protection	IP 65 (plastic body) IP 66 (metal body)	Rated operational current	
Rated insulation voltage plastic body	(U _i)	le/AC-15 230 VAC	3.1 A
according to IEC 60947-1 and EN 60947-1	500 V	le/AC-13 24 VDC	2.8 V
according to UL 508, CSA C22-2 n°14	A 600, Q 600	Electrical durability (according to IEC 60947-5-1 annex C)	
Rated insulation voltage metal body	(U _i)	max. switching frequency Cycles/h	3600
according to IEC 60947-1 and EN 60947-1	400 V (plastic body)	load factor	0.5
	500 V (PS31, PS43)	Air temperature near the device	
according to UL 508, CSA C22-2 n°14	A 300, Q 300 (PS21, PS42)	during operation	-25 to +70°C
	A 600, Q 600 (PS31, PS43)	for storage	-30 to +80°C
Conventional enclosed thermal voltage (U _{imp})	6 kV	Approvals	CE - UL - CSA

* also available in metal (M type) ** Ov.: overlapping travel paths

Limit switches - Limit type

Head types **PO** Plain plunger **PR** Roller plunger **RH** Plastic roller lever **RT** Nylon roller lever



Family: L

	PS43	PS43	PS43	PS43
	Metal	Metal	Metal	Metal
Dimensions HxWxD (mm)	66 x 102.5 x 43	66 x 115.5 x 43	67 x 129.5 x 43	66 x 128.5 x 61.5

References contact block

Snap 1NO+1NC	⊕	PS43L-PS11PO-M00	PS43L-PS11PR-M00	PS43L-PS11RH-M00	PS43L-PS11RT-M00
Slow 1NO+1NC	⊕	PS43L-PT11PO-M00	PS43L-PT11PR-M00	PS43L-PT11RH-M00	PS43L-PT11RT-M00
Slow Ov.**1NO+1NC	⊕	PS43L-PO11PO-M00	PS43L-PO11PR-M00	PS43L-PO11RH-M00	PS43L-PO11RT-M00
Slow 2NO		PS43L-PT20PO-M00	PS43L-PT20PR-M00	PS43L-PT20RH-M00	PS43L-PT20RT-M00
Slow 2NC	⊕	PS43L-PT02PO-M00	PS43L-PT02PR-M00	PS43L-PT02RH-M00	PS43L-PT02RT-M00
Snap 2NC	⊕	PS43L-PS02PO-M00	PS43L-PS02PR-M00	PS43L-PS02RH-M00	PS43L-PS02RT-M00
Slow 1NO+2NC	⊕	PS43L-PT12PO-M00	PS43L-PT12PR-M00	PS43L-PT12RH-M00	PS43L-PT12RT-M00
Slow 2NO+1NC	⊕	PS43L-PT21PO-M00	PS43L-PT21PR-M00	PS43L-PT21RH-M00	PS43L-PT21RT-M00
Slow 3NC	⊕	PS43L-PT03PO-M00	PS43L-PT03PR-M00	PS43L-PT03RH-M00	PS43L-PT03RT-M00
Slow 3NO		PS43L-PT30PO-M00	PS43L-PT30PR-M00	PS43L-PT30RH-M00	PS43L-PT30RT-M00

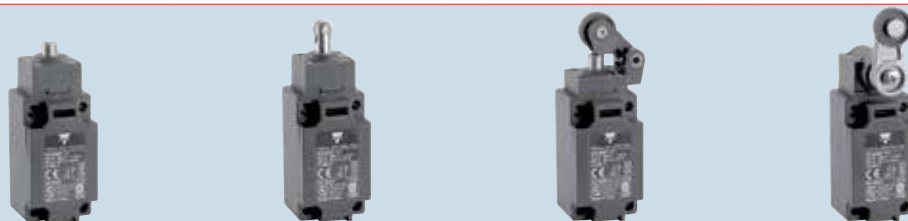

Family: L

	PS31	PS31	PS31	PS31
	Thermoplastic*	Thermoplastic*	Thermoplastic*	Thermoplastic*
Dimensions HxWxD (mm)	41 x 104 x 40.5	41 x 117 x 40.5	41 x 121 x 40.5	41 x 130 x 59

References contact block

Snap 1NO+1NC	⊕	PS31L-PS11PO-T00	PS31L-PS11PR-T00	PS31L-PS11RH-T00	PS31L-PS11RT-T00
Slow 1NO+1NC	⊕	PS31L-PT11PO-T00	PS31L-PT11PR-T00	PS31L-PT11RH-T00	PS31L-PT11RT-T00
Slow Ov.**1NO+1NC	⊕	PS31L-PO11PO-T00	PS31L-PO11PR-T00	PS31L-PO11RH-T00	PS31L-PO11RT-T00
Slow 2NO		PS31L-PT20PO-T00	PS31L-PT20PR-T00	PS31L-PT20RH-T00	PS31L-PT20RT-T00
Slow 2NC	⊕	PS31L-PT02PO-T00	PS31L-PT02PR-T00	PS31L-PT02RH-T00	PS31L-PT02RT-T00
Snap 2NC	⊕	PS31L-PS02PO-T00	PS31L-PS02PR-T00	PS31L-PS02RH-T00	PS31L-PS02RT-T00
Slow 1NO+2NC	⊕	PS31L-PT12PO-T00	PS31L-PT12PR-T00	PS31L-PT12RH-T00	PS31L-PT12RT-T00
Slow 2NO+1NC	⊕	PS31L-PT21PO-T00	PS31L-PT21PR-T00	PS31L-PT21RH-T00	PS31L-PT21RT-T00
Slow 3NC	⊕	PS31L-PT03PO-T00	PS31L-PT03PR-T00	PS31L-PT03RH-T00	PS31L-PT03RT-T00
Slow 3NO	⊕	PS31L-PT30PO-T00	PS31L-PT30PR-T00	PS31L-PT30RH-T00	PS31L-PT30RT-T00

* also available in metal (M type)

** Ov.: overlapping travel paths

Limit switches - Limit type

Head types

W1 Adjustable lever with Ø50 rubber roller

R1 Adjustable lever with Ø18 nylon roller

BE Ø50 nylon roller lever

LW Stainless steel spring cat whisker



Family: L

	PS43 Metal	PS43 Metal	PS43 Metal	PS43 Metal
Dimensions HxWxD (mm)	62 x (147.5-203.5) x 62.5	62 x (133.5-189.5) x 60	62 x 142.5 x 66	62 x 195,5 x 43

References contact block

Snap 1NO+1NC	⊕	PS43L-PS11W1-M00	PS43L-PS11R1-M00	PS43L-PS11W0-M00	PS43L-PS11LW-M00
Slow 1NO+1NC	⊕	PS43L-PT11W1-M00	PS43L-PT11R1-M00	PS43L-PT11W0-M00	PS43L-PT11LW-M00
Slow Ov.**1NO+1NC	⊕	PS43L-PO11W1-M00	PS43L-PO11R1-M00	PS43L-PO11W0-M00	PS43L-PO11LW-M00
Slow 2NO		PS43L-PT20W1-M00	PS43L-PT20R1-M00	PS43L-PT20W0-M00	PS43L-PT20LW-M00
Slow 2NC	⊕	PS43L-PT02W1-M00	PS43L-PT02R1-M00	PS43L-PT02W0-M00	PS43L-PT02LW-M00
Snap 2NC	⊕	PS43L-PS02W1-M00	PS43L-PS02R1-M00	PS43L-PS02W0-M00	PS43L-PS02LW-M00
Slow 1NO+2NC	⊕	PS43L-PT12W1-M00	PS43L-PT12R1-M00	PS43L-PT12W0-M00	PS43L-PT12LW-M00
Slow 2NO+1NC	⊕	PS43L-PT21W1-M00	PS43L-PT21R1-M00	PS43L-PT21W0-M00	PS43L-PT21LW-M00
Slow 3NC	⊕	PS43L-PT03W1-M00	PS43L-PT03R1-M00	PS43L-PT03W0-M00	PS43L-PT03LW-M00
Slow 3NO		PS43L-PT30W1-M00	PS43L-PT30R1-M00	PS43L-PT30W0-M00	PS43L-PT30LW-M00

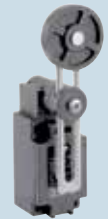

Family: L

	PS31 Thermoplastic*	PS31 Thermoplastic*	PS31 Thermoplastic*	PS31 Thermoplastic*
Dimensions HxWxD (mm)	50 x (149-205) x 65	41 x (135-191) x 60	50 x 144 x 64.5	41 x 195 x 40.5

References contact block

Snap 1NO+1NC	⊕	PS31L-PS11W1-T00	PS31L-PS11R1-T00	PS31L-PS11W0-T00	PS31L-PS11LW-T00
Slow 1NO+1NC	⊕	PS31L-PT11W1-T00	PS31L-PT11R1-T00	PS31L-PT11W0-T00	PS31L-PT11LW-T00
Slow Ov.**1NO+1NC	⊕	PS31L-PO11W1-T00	PS31L-PO11R1-T00	PS31L-PO11W0-T00	PS31L-PO11LW-T00
Slow 2NO		PS31L-PT20W1-T00	PS31L-PT20R1-T00	PS31L-PT20W0-T00	PS31L-PT20LW-T00
Slow 2NC	⊕	PS31L-PT02W1-T00	PS31L-PT02R1-T00	PS31L-PT02W0-T00	PS31L-PT02LW-T00
Snap 2NC	⊕	PS31L-PS02W1-T00	PS31L-PS02R1-T00	PS31L-PS02W0-T00	PS31L-PS02LW-T00
Slow 1NO+2NC	⊕	PS31L-PT12W1-T00	PS31L-PT12R1-T00	PS31L-PT12W0-T00	PS31L-PT12LW-T00
Slow 2NO+1NC	⊕	PS31L-PT21W1-T00	PS31L-PT21R1-T00	PS31L-PT21W0-T00	PS31L-PT21LW-T00
Slow 3NC	⊕	PS31L-PT03W1-T00	PS31L-PT03R1-T00	PS31L-PT03W0-T00	PS31L-PT03LW-T00
Slow 3NO	⊕	PS31L-PT30W1-T00	PS31L-PT30R1-T00	PS31L-PT30W0-T00	PS31L-PT30LW-T00

General specifications (for all types)

Degree of protection	IP 65 (plastic body) IP 66 (metal body)	Rated operational current	
Rated insulation voltage plastic body	(U _i)	le/AC-15 230 VAC	3.1 A
according to IEC 60947-1 and EN 60947-1	500 V	le/AC-13 24 VDC	2.8 V
according to UL 508, CSA C22-2 n°14	A 600, Q 600	Electrical durability (according to IEC 60947-5-1 annex C)	
Rated insulation voltage metal body	(U _i)	max. switching frequency Cycles/h	3600
according to IEC 60947-1 and EN 60947-1	400 V (PS21, PS42)	load factor	0.5
	500 V (PS31, PS43)	Air temperature near the device	
according to UL 508, CSA C22-2 n°14	A 300, Q 300 (PS21, PS42)	during operation	-25 to +70°C
	A 600, Q 600 (PS31, PS43)	for storage	-30 to +80°C
Conventional enclosed thermal voltage (U _{imp})	6 kV	Approvals	CE - UL - CSA

* also available in metal (M type) ** Ov.: overlapping travel paths

Limit switches - Safety type

Head types **Key Actuator 90° adj. head (key must be ordered separately)**



Family: S

	PS21	PS42	PS31	PS43
	Thermoplastic*	Thermoplastic*	Thermoplastic*	Thermoplastic*
Dimensions HxWxD (mm)	30.3 x 90 x 30	57 x 83 x 33	41.3 x 109.5 x 41	43 x 104.5 x 66

References contact block

Snap 1NO+1NC	⊕	PS21S-PS1105-T00	PS42S-PS1105-T00	PS31S-PS1105-T00	PS43S-PS1105-Y00
Snap 2NC	⊕	PS21S-PS0205-T00	PS42S-PS0205-T00	PS31S-PS0205-T00	PS43S-PS0205-Y00
Slow 1NO+1NC	⊕	PS21S-PT1105-T00	PS42S-PT1105-T00	PS31S-PT1105-T00	PS43S-PT1105-Y00
Slow Ov.**1NO+1NC	⊕	PS21S-PO1105-T00	PS42S-PO1105-T00	PS31S-PO1105-T00	PS43S-PO1105-Y00
Slow 2NC	⊕	PS21S-PT0205-T00	PS42S-PT0205-T00	PS31S-PT0205-T00	PS43S-PT0205-Y00
Slow 2NO+1NC	⊕			PS31S-PT2105-T00	PS43S-PT2105-Y00
Slow 1NO+2NC	⊕			PS31S-PT1205-T00	PS43S-PT1205-Y00
Slow 3NC	⊕			PS31S-PT0305-T00	PS43S-PT0305-Y00

Head types **Key actuator fully turnable head (key must be ordered separately)**

**Hinge Switch
Operated lever***



Family: S / H

	PS21	PS42	PS21	PS42
	Thermoplastic*	Thermoplastic*	Thermoplastic*	Thermoplastic*
Dimensions HxWxD (mm)	30.3 x 98.6 x 30	57 x 91.5 x 33	30.3 x 157 x 42	57 x 150 x 42

References contact block

Snap 1NO+1NC	⊕	PS21S-PS1109-T00	PS42S-PS1109-T00	PS21H-PS11HC-T00	PS42H-PS11HC-T00
Snap 2NC	⊕	PS21S-PS0209-T00	PS42S-PS0209-T00	PS21H-PS02HC-T00	PS42H-PS02HC-T00
Slow 1NO+1NC	⊕	PS21S-PT1109-T00	PS42S-PT1109-T00	PS21H-PT11HC-T00	PS42H-PT11HC-T00
Slow Ov.**1NO+1NC	⊕	PS21S-PO1109-T00	PS42S-PO1109-T00	PS21H-PO11HC-T00	PS42H-PO11HC-T00
Slow 2NC	⊕	PS21S-PT0209-T00	PS42S-PT0209-T00	PS21H-PT02HC-T00	PS42H-PT02HC-T00

Head types **Hinge shaft
Zinc plated steel**

**Hinge Shaft
Stainless steel**



Family: H

	PS21	PS42	PS21	PS42
	Thermoplastic*	Thermoplastic*	Thermoplastic*	Thermoplastic*
Dimensions HxWxD (mm)	30.3 x 79.5 x 51.2	57 x 72.5 x 52.5	30.3 x 79.5 x 51.2	30.3 x 72.5 x 52.5

References Contact Block

Snap 1NO+1NC	⊕	PS21H-PS11HZ-T00	PS42H-PS11HZ-T00	PS21H-PS11HS-T00	PS42H-PS11HS-T00
Snap 2NC	⊕	PS21H-PS02HZ-T00	PS42H-PS02HZ-T00	PS21H-PS02HS-T00	PS42H-PS02HS-T00
Slow 1NO+1NC	⊕	PS21H-PT11HZ-T00	PS42H-PT11HZ-T00	PS21H-PT11HS-T00	PS42H-PT11HS-T00
Slow Ov.**1NO+1NC	⊕	PS21H-PO11HZ-T00	PS42H-PO11HZ-T00	PS21H-PO11HS-T00	PS42H-PO11HS-T00
Slow 2NC	⊕	PS21H-PT02HZ-T00	PS42H-PT02HZ-T00	PS21H-PT02HS-T00	PS42H-PT02HS-T00

* also available in metal (M type) ** Ov.: overlapping travel paths

Limit switches - Safety type

Head types

Pull wire activated head
16 m cable max



Family: R

	PS31	PS43
	Metal	Metal
Dimensions HxWxD (mm)	40 x 162.75 x 43	63 x 158.25 x 43.3
References contact block		
Snap 1NO+1NC	PS31R-PS11N7-Y00	PS43R-PS11N7-Y00
Snap 2NC	PS31R-PS02N7-Y00	PS43R-PS02N7-Y00
Slow 1NO+1NC	PS31R-PT11N7-Y00	PS43R-PT11N7-Y00
Slow Ov.**1NO+1NC	PS31R-PO11N7-Y00	PS43R-PO11N7-Y00
Slow 2NC	PS31R-PT02N7-Y00	PS43R-PT02N7-Y00
Slow 2NO+1NC	PS31R-PT21N7-Y00	PS43R-PT21N7-Y00
Slow 1NO+2NC	PS31R-PT12N7-Y00	PS43R-PT12N7-Y00
Slow 3NC	PS31R-PT03N7-Y00	PS43R-PT03N7-Y00

Head types

Pull wire activated head
with pull button reset - 16 m cable max



Family: H

	PS31	PS43
	Metal	Metal
Dimensions HxWxD (mm)	40 x 162.75 x 43	63 x 158.25 x 44
References contact block		
Snap 1NO+1NC	PS31R-PS11N7-YK0	PS43R-PS11N7-YK0
Snap 2NC	PS31R-PS02N7-YK0	PS43R-PS02N7-YK0
Slow 1NO+1NC	PS31R-PT11N7-YK0	PS43R-PT11N7-YK0
Slow Ov.**1NO+1NC	PS31R-PO11N7-YK0	PS43R-PO11N7-YK0
Slow 2NC	PS31R-PT02N7-YK0	PS43R-PT02N7-YK0
Slow 2NO+1NC	PS31R-PT21N7-YK0	PS43R-PT21N7-YK0
Slow 1NO+2NC	PS31R-PT12N7-YK0	PS43R-PT12N7-YK0
Slow 3NC	PS31R-PT03N7-YK0	PS43R-PT03N7-YK0

General specifications (for all types)

Degree of protection	IP 65 (plastic body) IP 66 (metal body)	Rated operational current
Rated insulation voltage plastic body	(U _i)	le/AC-15 230 VAC 3.1 A
according to IEC 60947-1 and EN 60947-1	500 V	le/AC-13 24 VDC 2.8 V
according to UL 508, CSA C22-2 n°14	A 600, Q 600	Electrical durability (according to IEC 60947-5-1 annex C)
Rated insulation voltage metal body	(U _i)	max. switching frequency Cycles/h 3600
according to IEC 60947-1 and EN 60947-1	400 V (PS21, PS42)	load factor 0.5
	500 V (PS31, PS43)	Air temperature near the device
according to UL 508, CSA C22-2 n°14	A 300, Q 300 (PS21, PS42)	during operation -25 to +70°C
	A 600, Q 600 (PS31, PS43)	for storage -30 to +80°C
Conventional enclosed thermal voltage (U _{imp})	6 kV	Approvals CE - UL - CSA

* also available in metal (Y type) ** Ov.: overlapping travel paths

Limit switches - Safety type with pull button reset

Head Types	PO Steel plunger	PR Steel plunger with nylon roller	R3 Plastic roller lever on metal plunger	RT Lever with nylon roller
				



Family: K				
	PS21	PS21	PS21	PS21
	Thermoplastic*	Thermoplastic*	Thermoplastic*	Thermoplastic*
Dimensions HxWxD (mm)	30.3 x 88 x 36.5	30.3 x 99 x 36.5	30.3 x 107 x 36.5	39 x 106 x 45

References contact block					
Snap 1NO+1NC	⊕	PS21K-PS11PO-T00	PS21K-PS11PR-T00	PS21K-PS11R3-T00	PS43S-PS1105-Y00
Snap 2NC	⊕	PS21K-PS02PO-T00	PS21K-PS02PR-T00	PS21K-PS02R3-T00	PS43S-PS0205-Y00
Slow 1NO+1NC	⊕	PS21K-PT11PO-T00	PS21K-PT11PR-T00	PS21K-PT11R3-T00	PS43S-PT1105-Y00
Slow 2NC	⊕	PS21K-PT02PO-T00	PS21K-PT02PR-T00	PS21K-PT02R3-T00	PS21K-PT02RT-T00



Family: K				
	PS42	PS42	PS42	PS42
	Thermoplastic*	Thermoplastic*	Thermoplastic*	Thermoplastic*
Dimensions HxWxD (mm)	57 x 81 x 36.5	57 x 92 x 36.5	57 x 100 x 36.5	57 x 99 x 45

References contact block					
Snap 1NO+1NC	⊕	PS42K-PS11PO-T00	PS42K-PS11PR-T00	PS42K-PS11R3-T00	PS42K-PS11RT-T00
Snap 2NC	⊕	PS42K-PS02PO-T00	PS42K-PS02PR-T00	PS42K-PS02R3-T00	PS42K-PS02RT-T00
Slow 1NO+1NC	⊕	PS42K-PT11PO-T00	PS42K-PT11PR-T00	PS42K-PT11R3-T00	PS42K-PT11RT-T00
Slow 2NC	⊕	PS42K-PT02PO-T00	PS42K-PT02PR-T00	PS42K-PT02R3-T00	PS42K-PT02RT-T00

Head Types	R4 Roller Lever, external side actuation	LR Roller Lever Ø22, side actuation
		









Family: K		
	PS21	PS42
	Thermoplastic*	Thermoplastic*
Dimensions HxWxD (mm)	44 x 107 x 36.5	57 x 112 x 36.5

References contact block			
Snap 1NO+1NC	⊕	PS21K-PS11R4-T00	PS42K-PS11LR-T00
Snap 2NC	⊕	PS21K-PS02R4-T00	PS42K-PS02LR-T00
Slow 1NO+1NC	⊕	PS21K-PT11R4-T00	PS42K-PT11LR-T00
Slow 2NC	⊕	PS21K-PT02R4-T00	PS42K-PT02LR-T00

General specifications (for all types)			
Degree of protection	IP 65	Rated operational current	
Rated insulation voltage plastic body	(U _i)	le/AC-15 230 VAC	3.1 A
according to IEC 60947-1 and EN 60947-1	500 V	le/AC-13 24 VDC	2.8 V
according to UL 508, CSA C22-2 n°14	A 600, Q 600	Electrical durability (according to IEC 60947-5-1 annex C)	
Rated insulation voltage metal body	(U _i)	max. switching frequency Cycles/h	3600
according to IEC 60947-1 and EN 60947-1	400 V	load factor	0.5
	500 V	Air temperature near the device	
according to UL 508, CSA C22-2 n°14	A 300, Q 300 (PS21, PS42)	during operation	-25 to +70°C
	A 600, Q 600 (PS31, PS43)	for storage	-30 to +80°C
Conventional enclosed thermal voltage (U _{imp})	6 kV	Approvals	CE - UL - CSA





* Also available in metal (Y type) other types available

Industrial and Midi industrial relays

		Industrial relays		Midi industrial relays	
Types	RCP 8 (2 Poles)	RCP 11 (3 Poles)	RMI 2-10 (2 Poles)	RMI 4-5 (4 Poles)	
					
Dimensions HxWxD (mm)	56 x 35.5 x 35.5	56 x 35.5 x 35.5	36 x 21.5 x 28	36 x 21.5 x 28	
No. of Contacts	2 Change-over (octal)	3 Change-over (undecal)	2 Change-over	4 Change-over	
Contact rating	10 A	10 A	10 A	5 A	
Features	Test button / Flag / LED	Test button / Flag / LED	Test button / Flag / LED	Test button / Flag / LED	
Output specifications					
Max. load AC1	12 A / 250 VAC	12 A / 250 VAC	12 A / 250 VAC	6 A / 250 VAC	
Min. load	100 mA / 12 VDC	100 mA / 125 VDC	100 mA / 5 VDC	100 mA / 5 VDC	
Electrical life	> 100.000 cycles	> 100.000 cycles	> 100.000 cycles	> 100.000 cycles	
Switching power	2500 VA (resistive)	2500 VA (resistive)	2500 VA (resistive)	1250 VA (resistive)	
General specifications					
Voltage ranges VDC	6 - 12 - 24 - 48 - 60 - 100 - 110	6 - 12 - 24 - 48 - 60 - 100 - 110	5 - 6 - 9 - 12 - 24 - 36 - 48 - 60 - 100 - 110 - 220 - 240	5 - 6 - 9 - 12 - 24 - 36 - 48 - 60 - 100 - 110 - 220 - 240	
Voltage ranges VAC	6 - 12 - 24 - 48 - 115/120 - 230	6 - 12 - 24 - 48 - 115/120 - 230	6 - 12 - 24 - 36 - 48 - 115/120 - 220 - 240 - 380	6 - 12 - 24 - 36 - 48 - 115/120 - 220 - 240 - 380	
Insulation according to	EN 61810-5	EN 61810-5	EN 61810-5	EN 61810-5	
Consumption	1.5 W DC-2.5 VA AC	1.5 W DC-2.5 VA AC	1 W DC-1.5 VA AC	1 W DC-1.5 VA AC	
Approvals / Conformity	cURus - CSA - IMQ - RINA	cURus - CSA - IMQ - RINA	cURus - CSA - TÜV - CQC	cURus - CSA - TÜV - CQC	
References					
5 VDC			RMIA/B2-105 DC	RMIA/B4-55 DC	
6 VAC	RCP80026 VDC	RCP110036 VDC	RMIA/B2-106 AC	RMIA/B4-56 AC	
6 VDC	RCP80026 VAC	RCP110036 VAC	RMIA/B2-106 DC	RMIA/B4-56 DC	
12 VAC	RCP800212 VAC	RCP1100312 VAC	RMIA/B2-1012 AC	RMIA/B4-512 AC	
12 VDC	RCP800212 VDC	RCP1100312 VDC	RMIA/B2-1012 DC	RMIA/B4-512 DC	
24 VAC	RCP800224 VAC	RCP1100324 VAC	RMIA/B2-1024 AC	RMIA/B4-524 AC	
24 VDC	RCP800224 VDC	RCP1100324 VDC	RMIA/B2-1024 DC	RMIA/B4-524 DC	
48 VAC	RCP800248 VAC	RCP1100348 VAC	RMIA/B2-1048 AC	RMIA/B4-548 AC	
48 VDC	RCP800248 VDC	RCP1100348 VDC	RMIA/B2-1048 DC	RMIA/B4-548 DC	
60 VDC	RCP800260 VDC	RCP1100360 VDC	RMIA/B2-1060 DC	RMIA/B4-560 DC	
100 VDC	RCP8002100 VDC	RCP11003100 VDC	RMIA/B2-10100 DC	RMIA/B4-5100 DC	
110 VDC	RCP8002110 VDC	RCP11003110 VDC	RMIA/B2-10110 DC	RMIA/B4-5110 DC	
115/120 VAC	RCP8002115/120 VAC	RCP11003115/120 VAC	RMIA/B2-10115 AC	RMIA/B4-5115 AC	
230 VAC	RCP8002230 VDC	RCP11003230 VDC	RMIA/B2-10230 AC	RMIA/B4-5230 AC	
		Industrial relays sockets		Midi industrial relays sockets	
Types	ZPD 8XA ZPD 11XA	ZPD 8A ZPD 11A	ZMI 2NA ZMI 4NA	ZMI 2 / 3 / 4SA	
					
General specifications					
Dimensions HxWxD (mm)	65 X 27 X 38	65 X 27 X 38	42.5 x 75 x 27	42.5 x 75 x 27	
Rated volt. / Rated curr.	10 A @ 400 VAC	10 A @ 400 VAC	10 A @ 300 VAC	10/12 A @ 300 VAC	
Insulation voltage	> 3 kV	> 3 kV	> 4 kV	> 4 kV	
Socket material	Self-ext. PA6 + GF (V1)	Self-ext. PA6 + GF (V1)	Self-ext. PA6 + GF (V2)	Self-ext. PA6 + GF (V2)	
Mounting	DIN-rail	DIN-rail	DIN-rail	DIN-rail	
Degree of protection	IP 20	IP 20	IP 20	IP 20	
Approvals	CE - UL - CSA (10 A 300 VCA)	CE - cURus - CSA - IMQ - RINA	CE - cURus - CSA	CE - cURus - CSA	
References					
For RCP 8 / RCP 11	ZPD 8XA / ZPD 11XA	ZPD 8A / ZPD 11A			
For RMI2-10 / RMI4-5			ZMI 2NA / ZMI 4NA	ZMI 2 / 3 / 4SA	

Midi industrial relays

Midi industrial relays

Types	RPY 1	RPY 2	RPY 3	RPY 4
				
Dimensions HxWxD (mm)	36 x 21.5 x 28	36 x 21.5 x 28	36 x 31.5 x 28	36 x 41.5 x 28
No. of Contacts	1 Change-over	2 Change-over	3 Change-over	4 Change-over
Contact rating	16 A	10 A	10 A	10 A
Terminal types	Faston or PCB	Faston or PCB	Faston or PCB	Faston or PCB

Output specifications

Max. load AC1	16 A	10 A	10 A	10 A
Electrical life	1 x 10 ⁵	1 x 10 ⁵	1 x 10 ⁵	1 x 10 ⁵
Switching power	1 HP at 240 VAC 1/2 HP at 120 VAC	3/4 HP at 240 VAC 1/3 HP at 120 VAC	3/4 HP at 240 VAC 1/3 HP at 120 VAC	3/4 HP at 240 VAC 1/3 HP at 120 VAC

General specifications

Voltage ranges VDC	6 - 9 - 12 - 24 - 36 - 48 100 - 110 - 220 - 240	6 - 9 - 12 - 24 - 36 - 48 100 - 110 - 220 - 240	6 - 9 - 12 - 24 - 36 - 48 100 - 110 - 220	6 - 9 - 12 - 24 - 36 - 48 100 - 110 - 220
Voltage ranges VAC	6 - 12 - 24 - 36 - 48 - 110 120 - 120 - 220 - 240 - 380	6 - 12 - 24 - 36 - 48 - 110 120 - 120 - 220 - 240 - 380	6 - 12 - 24 - 36 - 48 - 110 120 - 120 - 220 - 240 - 380	6 - 12 - 24 - 36 - 48 - 110 120 - 120 - 220 - 240 - 380
Insulation Coil / Contact	2000/1200 VAC	2000/1200 VAC	2000/1200 VAC	2000/1200 VAC
Consumption	DC=0.9 W - AC=1.2 VA	DC=0.9 W - AC=1.2 VA	DC=1.4 W - AC=2 VA	DC=1.5 W - AC=2.5 VA
Approvals / Conformity	UL - CSA - TÜV	UL - CSA - TÜV	UL - CSA - TÜV	UL - CSA - TÜV

References

Consult your Carlo Gavazzi Partner or Distributor	Several options available: Led, diode, etc...	Several options available: Led, diode, etc...	Several options available: Led, diode, etc...	Several options available: Led, diode, etc...
---	--	--	--	--

Midi industrial relays sockets

Types	ZPY08A	ZPY11A	ZPY14A
			

General specifications

Dimensions HxWxD (mm)	27.8 x 30 x 69.8	27.8 x 40 x 69.8	27.8 x 50.5 x 69.8
Rated volt. / Rated curr.	10 A @ 300 VAC	10 A @ 300 VAC	10 A @ 300 VAC
Insulation voltage	> 4 kW	> 4 kW	> 4 kW
Socket material	PA6 - V2	PA6 - V2	PA6 - V2
Mounting	DIN Rail	DIN Rail	DIN Rail
Degree of protection	IP 00	IP 00	IP 00
Approvals	UL - cUL - CSA	UL - cUL - CSA	UL - cUL - CSA

References

Consult your Carlo Gavazzi Partner or Distributor	For Relays: RPYA 001 and RPYA 002	For Relays: RPYA 003	For Relays: RPYA 004
---	-----------------------------------	----------------------	----------------------

Industrial and Midi industrial relays

Slim relays

Types

RSLM100

RSLM001



Dimensions HxWxD (mm)	15 x 28 x 5	15 x 28 x 5
No. of Contacts	1 Normally open	1 Change-over
Contact rating	6 A	6 A

Output specifications

Max. load AC1	6 A / 250 VAC	6 A / 250 VAC
Min. load	170 mW / 24 VDC 210 mW / 48-60 VDC	170 mW / 24 VDC 210 mW / 48-60 VDC
Mechanical endurance	> 100,000 cycles	> 100,000 cycles
Switching power	1500 VA	1500 VA

General specifications

Voltage ranges VDC	12 - 24 - 48 - 60	12 - 24 - 48 - 60
Consumption	170 mW ~ 210 mW	170 mW ~ 210 mW
Approvals / Conformity	cURus - CSA - VDE - CQC	cURus - CSA - VDE - CQC

References

12 VDC	RSLM100012	RSLM001012
24 VDC	RSLM100024	RSLM001024
48 VDC	RSLM100048	RSLM001048
60 VDC	RSLM100060	RSLM001060

SLIM Relay Sockets

Types

ZRLS1.NA

ZRLS1.GA

ZRLP

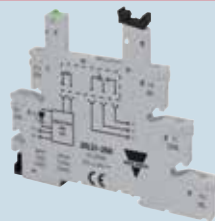

General specifications

Dimensions HxWxD (mm)	88 x 55 x 6	101 x 80 x 6	33 x 30 x 6
Rated volt. / Rated curr.	6 A @ 300 VAC	6 A @ 300 VAC	6 A @ 300 VAC
Insulation voltage	> 3 kV	> 3 kV	> 3 kV
Socket material	PA66 + GF (VO)	PA66 + GF (VO)	PA66 + GF (VO)
Mounting	DIN-rail	DIN-rail	PCB
Terminal Type	Screw cage	Spring loaded	
Approvals	CE - cURus	CE - cURus	CSA - UR



References

Input Voltage 6~24 VAC/VDC	ZRLS12NA	ZRLS12GA
Input Voltage 48~60 VAC/VDC	ZRLS13NA	ZRLS13GA
Input Voltage 110~125 VAC/VDC	ZRLS14NA	ZRLS14GA
Input Voltage 220~240 VAC/VDC	ZRLS15NA	ZRLS15GA

ZRLP

Power relays

Power relays

Types	NB (1/2 Poles)	NF (1/2 Poles)	NP (1/2 Poles)
			
Dimensions HxWxD (mm)	55 x 50.5 54.5	36 x 50.5 x 54.5	36 x 50.5 x 33.5
No. of Contacts	1 Normally open 2 Normally open	1 Normally open 2 Normally open	1 Normally open 2 Normally open
Contact rating	30 A	30 A	30 A
Terminal types	Bolt	Faston	PCB
Output specifications			
Max. load AC1	30 A (1NO) - 25 A (2NO)	30 A (1NO) - 25 A (2NO)	30 A (1NO) - 25 A (2NO)
Electrical life	1 x 10 ⁵	1 x 10 ⁵	1 x 10 ⁵
Switching power	7500 VA / 840 W	7500 VA / 840 W	7500 VA / 840 W
General specifications			
Voltage ranges VDC	3 - 6 - 12 - 24 - 48 - 100 - 110 - 200	3 - 6 - 12 - 24 - 48 - 100 - 110 - 200	3 - 6 - 12 - 24 - 48 - 100 - 110 - 200
Voltage ranges VAC	6 - 12 - 24 - 48 - 120 - 220	6 - 12 - 24 - 48 - 120 - 220	6 - 12 - 24 - 48 - 120 - 220
Insulation according to	4000 VAC	4000 VAC	4000 VAC
Consumption	DC=1.9 W - AC=2.7 VA	DC=1.9 W - AC=2.7 VA	DC=1.9 W - AC=2.7 VA
Approvals / Conformity	UL - cUL	UL - cUL	UL - cUL

Power relays

Power relays

CF (2 Poles)



CS (2 Poles)



Dimensions (mm) WxHxD	26.42 x 68.58 x 34.54	26.42 x 52.32 x 34.54
No. of Contacts	2 Normally open 2 Change-over	2 Normally open 2 Change-over
Contact rating	30 A	30 A
Terminal types	Faston	PCB
Output specifications		
Max. load AC1	30 A (2NO) - 20 A (2CO)	30 A (2NO) - 20 A (2CO)
Electrical life	1 x 10 ⁵	1 x 10 ⁵
Switching power	8310 VA / 840 W	8310 VA / 840 W
General specifications		
Voltage ranges VDC	6 - 12 - 24 - 48	6 - 12 - 24 - 48
Voltage ranges VAC	24 - 120 - 208 - 240 - 277	24 - 120 - 208 - 240 - 277
Insulation according to	4000 VAC	4000 VAC
Consumption	DC=1.7 W - AC=4 VA	DC=1.7 W - AC=4 VA
Approvals / Conformity	UL - cUL	UL - cUL

Sockets for electromechanical relays

Types	ZD 35/2A	ZD 50/2A	ZD 35/3A	ZD 50/3A

General specifications

Rated volt. / Rated curr.	12 A @ 300 VAC	12 A @ 300 VAC	12 A @ 300 VAC	12 A @ 300 VAC
Insulation voltage	> 5 kV	> 5 kV	> 5 kV	> 5 kV
Socket material	Self-ext. PA6 + GF (V1)	Self-ext. PA6 + GF (V1)	Self-ext. PA6 + GF (V1)	Self-ext. PA6 + GF (V1)
Mounting	DIN-rail	DIN-rail	DIN-rail	DIN-rail
Degree of protection	IP 20	IP 20	IP 20	IP 20
Approvals	UL - CSA (12 A, 300 VCA)	UL - CSA (12 A, 300 VCA)	UL - CSA (12 A, 300 VCA)	UL - CSA (12 A, 300 VCA)

References

For relay:	MZ 1P 5/10 A	MZ B 1P 5/10 A	MZ 1P 5/10 A	MZ B 1P 5/10 A
	M15 M 8 A	MZ 2P 5/10 A	M15 M 8 A	MZ 2P 5/10 A
	M25 1P 12 A	MZ 1P 16 A	M25 1P 12 A	MZ 1P 16 A
	LC 10 A	M15 M 8 A	LC 10 A	M15 M 8 A
		M25 1P 16 A		M25 1P 16 A
		M25 2P 8 A		M25 2P 8 A
	LC 5/16 A		LC 5/16 A	

For detailed informations consult your Carlo Gavazzi Partner or Distributor

Hold down spring to be ordered separately:
 • SZD15 for M15/M25 relays
 • SZD20 for LC relays
 • SZD25 for MZ relays

Hold down spring to be ordered separately:
 • SZD15 for M15/M25 relays
 • SZD20 for LC relays
 • SZD25 for MZ relays

Hold down spring to be ordered separately:
 • SZD15 for M15/M25 relays
 • SZD20 for LC relays
 • SZD25 for MZ relays

Hold down spring to be ordered separately:
 • SZD15 for M15/M25 relays
 • SZD20 for LC relays
 • SZD25 for MZ relays

Types

Additional modules for ZMI and ZD sockets



General specifications

Dimensions (mm) WxHxD	23 x 12.5 x 8.5
Terminal material	CuSn
Degree of protection	IP 40
Operating temperature	-40°C to +70°C
Ambient humidity	85RH non condensing
Approvals / Conformity	No approvals

References

Consult your Carlo Gavazzi Partner or Distributor

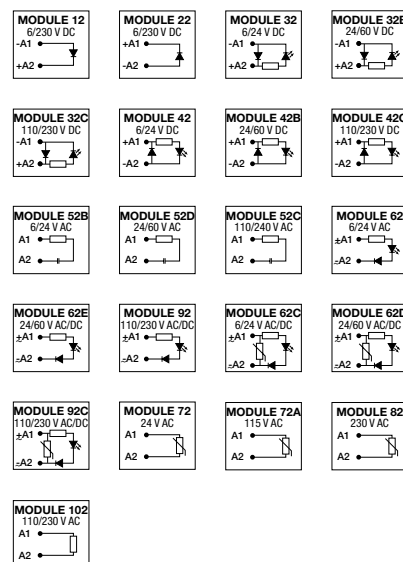





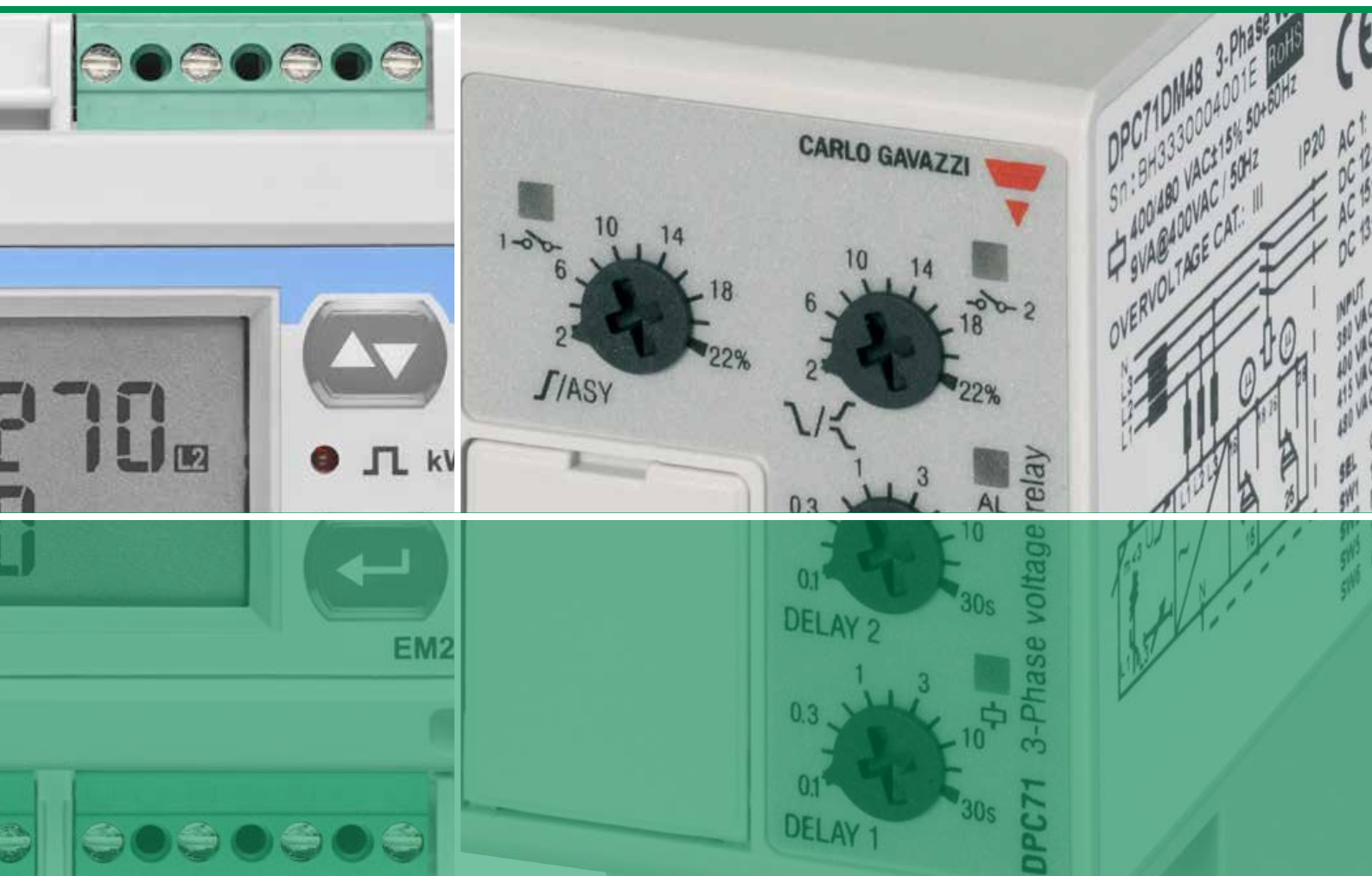

Controls



Energy management	174
Current transformers	184
Energy monitoring solution	192
PV monitoring solution	195
Monitoring relays	200
Timers	212
Counters	217
Surge arresters	220
Digital panel meters	222
Converters and Gateway	226
Safety modules	227
Configurable safety modules	231
Switching power supplies	233





Energy management

	Energy meter	Energy analyzer	Energy analyzer	
Types	EM10 DIN	EM11 DIN	EM210 AV	EM210 MV
				
Dimensions HxWxD (mm)	90 x 18 x 67	90 x 18 x 67	72 x 72 x 65	72 x 72 x 65
Description	1-phase energy meter 1-DIN module	1-phase energy analyzer 1-DIN module	3-phase energy analyzer 4-DIN modules and 72 x 72 panel mounting	3-phase energy analyzer 4-DIN modules and 72 x 72 panel mounting
Function	kWh TRMS method	V, A, Hz, W, W _{dmd} , var, PF, kWh, kvarh TRMS method	System: ±kWh, kvarh, W, var, PF, An and h-meter (only [X]), Phase-sequence Single-phase: V _{LL} , V _{LN} , A, PF, THD (V, A, up to 15th H. THD only [X]) TRMS method	System: ±kWh, kvarh, W, var, PF, An, h-meter, Phase-sequence Single-phase: V _{LL} , V _{LN} , A, PF, THD (V, A, up to 15th H.) TRMS method
Input specifications				
Range code	120 VAC [AV7] 230 VAC [AV8] Ib: 5 A, I _{max} : 32 AAC	120 VAC [AV7] 230 VAC [AV8] Ib: 5 A, I _{max} : 32 AAC	120 / 230 VAC, 400 VAC In: 5 A; I _{max} : 6 A (current connection by CT)	120 / 230 VAC, 400 VAC By 333mV CT [CTV] or by Rogowski sensors [ROG4K]
Accuracy		±0.5% RDG (V, A)	±0.5% RDG (V, A)	±0.5% RDG (V, A)
Active energy	Class 1 (EN62053-21) Class B (EN50470-3)	Class 1 (EN62053-21) Class B (EN50470-3)	Class 1 (EN62053-21) Class B (EN50470-3)	Class 1 (EN62053-21)
Reactive energy		Class 2 (EN62053-23)	Class 2 (EN62053-23)	Class 2 (EN62053-23)
Display	LCD 4+2, 5+1, 6 DGT (kWh)	LCD 4 DGT (inst. variables) 4+2, 5+1, 6 DGT (energies)	LCD 3 DGT (inst. variables) 5+2, 6+1, 7 DGT (energies)	LCD 3 DGT (inst. variables) 5+2, 6+1, 7 DGT (energies)
Output specifications				
Pulse output	1-open collector	1-open collector	1 static opto-mosfet	1 static opto-mosfet
Alarm output		1-relay		
Communication			RS485 (2-wire, Modbus)	RS485 (2-wire, Modbus)
General specifications				
Power supply	Self power supply [X]	Self power supply [X]	Self power supply [X] Universal power supply 90-260 VAC/DC [H] (MID version)	Self power supply
Approvals/Marks	CE - cULus - MID [AV8]	CE - cULus - MID [AV8]	CE - cULus - MID [PF]	CE - cULus
References				
For ordering key details, please refer to www.productselection.net				

Energy management

	Energy meter	Quick-fit dual energy meter	3-phase current transformer	Panel adapter for energy meter
Types	EM21 72R	EM270	TCD X	EM200-96 Adapter
				
Dimensions HxWxD (mm)	72 x 72 x 65	72 x 72 x 65	TCD1X: 72 x 75 x 66.8 TCD2X: 72 x 105 x 50 TCD3X: 78 x 135 x 50	96 x 96 x 41.4
Description	3-phase energy meter 4-DIN modules and 72 x 72 panel mounting	3-phase energy meter 4-DIN modules and 72 x 72 panel mounting	3-phase current transformers for EM270 quick fit meter. Connection to the meter by means of RJ11 connector (included).	Adapter frame from 72 x 72 mm to 96 x 96 mm panel mounting. Installation by fixing brackets included in the meter.
Function	System: kWh, kvarh, W, var, PF, Hz, Phase sequence Single-phase: V _{LN} , V _{LL} , A, PF TRMS method	System: kWh, kvarh, kW, kvar Single-phase: kWh, W, W _{dmd} , W _{dmd max} , A, V _{LL} , V _{LN} Virtual sum of the two 3-phase or six 1-phase loads TRMS method	Suitable to be installed downstream the circuit breakers (same width). Automatic setting of the CT ratio in the meter	Suitable for EM210, EM270, EM271, EM280, EM21-72D, EM21-72R, EM21-72V
Input specifications				
Range	120 / 230 VAC, 400 VAC 3-phase current input by included current sensors (three ranges available: 90A - 150A - 250A)	120 / 230 VAC, 400 VAC In: from 160 to 630 A by TCD X	TCD1X: 160 A TCD2X: 250 A TCD3X: 630 A	
Accuracy	±0.5% RDG (V) ±1% RDG (A)	±0.5% RDG (V, A)	Equivalent to Class 0.5 (IEC61869-2)	
Active energy	Class 2 (EN62053-21)	Equivalent to Class 1 (EN62053-21)		
Reactive energy		Equivalent to Class 2 (EN62053-23)		
Display	LCD 3 DGT (inst. variables) 6+1, 7 DGT (energies)	LCD 3 DGT (inst. variables) 6+1, 7 DGT (energies)		
Output specifications				
Pulse output	1 static opto-mosfet	2 static opto-mosfet		
Communication	RS485 (2-wire, Modbus) M-BUS by means of VMU-B	RS485 (2-wire, Modbus) M-BUS by means of VMU-BM2...B		
General specifications				
Power supply	Self power supply	Self power supply	n.a.	
Approvals/Marks	CE - cULus	CE - cULus	CE - cULus (with EM 270)	CE
References				
For ordering key details, please refer to www.productselection.net				

Energy management

	Quick fit dual energy meter	3-phase current transformer	Quick fit 6-channel energy meter	6-channel current transformer block
Types	EM271	TCD M	EM280	TCD06B
				
Dimensions HxWxD (mm)	72 x 72 x 65	TCD0M: 3 by 26 x 40 x 26, hole 9.6 TCD1M: 3 by 31 x 46 x 31, hole 15.7 TCD2M: 3 by 41 x 66 x 38, hole 15.5 TCD3M: 3 by 50 x 78 x 39, hole 20.5	72 x 72 x 65	TCD06BX (solid core): 118 x 53 x 34, hole 7.0, hole centre distance 17.5 TCD06BS (split core): 118 x 45 x 59, hole 8.5, hole centre distance 17.5
Description	Quick fit energy meter with daisy chaining of voltage and serial connections and fast RJ connection of TCD M 3-phase split-core current sensors, for retrofit applications. Managing of two 3-phase or six 1-phase loads. 4-DIN modules and 72 x 72 panel mounting	3-phase split core current sensors for EM271 quick fit meter. Connection to the meter by means of RJ11 connector (included)	Quick fit energy meter with daisy chaining of voltage and serial connections and fast RJ connection of TCD06B 6-channel current transformer block. Managing of two 3-phase or six 1-phase loads. 4-DIN modules and 72 x 72 panel mounting	6-channel current transformer blocks with hole centre distance 17.5 mm (same of miniature circuit breakers) for EM280 quick fit meter. Connection to the meter by means of RJ11 connector (included)
Function	System: kWh, kvarh, kW, kvar Single-phase: kWh, W, W _{dmd} , W _{dmd max} , A, V _{LL} , V _{LN} Virtual sum of the two 3-phase or six 1-phase loads TRMS method	Suitable to be installed in any existing installation. Automatic setting of the CT ratio in the meter	System: kWh, kvarh, kW, kvar Single-phase: kWh, W, W _{dmd} , W _{dmd max} , A, V _{LL} , V _{LN} Virtual sum of the two 3-phase or six 1-phase loads TRMS method	Suitable to be installed in any new and existing installation. Automatic setting of the CT ratio in the meter
Input specifications				
Range	120 / 230 VAC, 400 VAC In: from 60 to 400 A by TCD M	TCD0M: 60 A TCD1M: 100 A TCD2M: 200 A TCD3M: 400 A	120 / 230 VAC, 400 VAC In: 32 A by TCD06BX and TCD06BS	TCD06B: 32 A
Accuracy	±0.5% RDG (V, A)	Equivalent to Class 1 (IEC61869-2)	±0.5% RDG (V, A)	Equivalent to Class 0.5 (IEC61869-2)
Active energy	Equivalent to Class 1 (EN62053-21)		Equivalent to Class 1 (EN62053-21)	
Reactive energy	Equivalent to Class 2 (EN62053-23)		Equivalent to Class 2 (EN62053-23)	
Display	LCD 3 DGT (inst. variables) 6+1, 7 DGT (energies)		LCD 3 DGT (inst. variables) 6+1, 7 DGT (energies)	
Output specifications				
Pulse output	2 static opto-mosfet		2 static opto-mosfet	
Communication	RS485 (2-wire, Modbus)		RS485 (2-wire, Modbus)	
General specifications				
Power supply	Self power supply		Self power supply	
Approvals/Marks	CE - cULus	CE - cULus (with EM 271)	CE - cULus	CE - cULus (with EM 280)
References				
For ordering key details, please refer to www.productselection.net				

Energy management

Multifunction meter

Energy analyzer

Types

WM10 DIN

EM24 DIN

EM340



Dimensions HxWxD (mm)	90 x 72 x 67	90 x 72 x 67	90 x 54 x 63
Description	3-phase multifunction meter 4 DIN modules	3-phase energy analyzer 4 DIN modules	3-phase energy analyzer with Touch Tech technology and wrong connection detection 3-DIN modules
Function	System: V_{LN} , V_{LL} , W , var , PF , Hz , phase sequence Single-phase: V_{LN} , V_{LL} , A , W , var TRMS method	System: $\pm kWh$, $\pm kvarh$, V_{LL} , V_{LN} , var , VA , W_{dmd} , W , VA_{dmd} , Hz , hour counter, gas and water Max: A_{dmd} , W_{dmd} , VA_{dmd} Single-phase: V_{LL} , V_{LN} , A , W , var , VA , PF , kWh , $kvarh$ TRMS method	System: $\pm kWh$, $\pm kvarh$, $kWh+$ by tariff (2), V_{LN} , V_{LL} , PF , Hz , $\pm W$, W_{dmd} , $W_{dmd} max$, $\pm var$, VA Single-phase: kWh , V_{LN} , V_{LL} , A , PF , W , var , VA TRMS method

Input specifications

Range code	400 V_{LLAC} Ib: 10 A; I _{max} 65 A 3-phase	120 / 208 V_{LL} [AV6]; 400 V_{LL} [AV5] In: 1 / 5 A, I _{max} : 10 AAC [AV5 and AV6]; 208/400 V_{LL} [AV2] 400 V_{LL} [AV9] Ib: 10A, I _{max} : 65AAC (AV2 and AV9)	3-phase 208-400 V_{LLAC} [AV2] Ib: 5 A, I _{max} : 65 AAC; 3-phase
Accuracy	$\pm 0.5\%$ RDG (V, A)	$\pm 0.5\%$ RDG (V, A)	$\pm 0.5\%$ RDG (V, A)
Active energy		Class 1 (EN62053-21) Class B (EN50470-3)	Class 1 (EN62053-21) Class B (EN50470-3)
Reactive energy		Class 2 (EN62053-23)	Class 2 (EN62053-23)
Display	LCD 3 x 3 DGT (inst. variables)	LCD 3x 4 DGT (inst. variables) 6+2, 7+1, 8 DGT (energies)	Backlit LCD with touch keypad 3x 4 DGT (inst. variables) 3x 6+2, 7+1, 8 DGT (energies)

Output specifications

Pulse output		2-open collector / relay	1-open collector [O1]
Alarm output		2-relay / open collector	
Communication		Modbus RTU [S1] / M-BUS [Mx] / Dupline [DP]	Modbus RTU [S1] M-bus [MT]
Inputs		3 digital input	1 (dual tariff management)



General specifications

Power supply	Self power supply	Self power supply [X] (AV2 and AV9). Auxiliary power supply: 18 to 60 VAC/DC [L], 115 / 230 VAC [D], according to the model (AV5 and AV6)	Self power supply [X]
Approvals/Marks	CE	CE - cULus [AV5 and AV6] - MID	CE - MID

References

For ordering key details, please refer to www.productselection.net

Energy management

	Energy meter		Energy analyzer	
Types	EM110	EM111	EM112	EM112
				
Dimensions HxWxD (mm)	90 x 18 x 63	90 x 18 x 63	90 x 36 x 63	
Description	1-phase energy meter kWh 1-DIN module	1-phase energy analyser with Touch Tech technology 1-DIN module	1-phase energy analyser with Touch Tech technology 2-DIN modules	
Function	kWh	V_{LN} , A, Hz, $\pm W$, W_{dmd} , $W_{dmd\ max}$, $\pm var$, PF, $\pm kWh$, $\pm kvarh$, kWh+ by tariff (2) TRMS method	V_{LN} , A, Hz, $\pm W$, W_{dmd} , $W_{dmd\ max}$, $\pm var$, PF, $\pm kWh$, $\pm kvarh$, kWh+ by tariff (2) TRMS method	
Input specifications				
Range code	120 VAC [AV7] 230 VAC [AV8] Ib: 5 A, I _{max} : 45 AAC; 1-phase	120 VAC [AV7] 230 VAC [AV8] Ib: 5 A, I _{max} : 45 AAC; 1-phase	120 VAC [AV1] 230 VAC [AV0] Ib: 5 A, I _{max} : 100 AAC; 1-phase	
Accuracy	n.a.	$\pm 0.5\%$ RDG (V, A)	$\pm 0.5\%$ RDG (V, A)	
Active energy	Class 1 (EN62053-21) Class B (EN50470-3)	Class 1 (EN62053-21) Class B (EN50470-3)	Class 1 (EN62053-21) Class B (EN50470-3)	
Reactive energy	n.a.	Class 2 (EN62053-23)	Class 2 (EN62053-23)	
Display	Electromechanical 6+1 DGT (energy)	Backlit LCD with touch keypad 4 DGT (inst. variables) 5+2, 6+1, 7 DGT (energies)	Backlit LCD with touch keypad and supercapacitor backup (up to 48h) up to 2 x 4 DGT (inst. variables) 6+2, 7+1, 8 DGT (energies)	
Output specifications				
Pulse output	1-open collector [O1]	1-open collector [O1]	1-open collector [O1]	
Communication		Modbus RTU [S1] M-bus [M1]	Modbus RTU [S1] M-bus [M1]	
Inputs		1 (dual tariff management)	1 (dual tariff management)	
General specifications				
Power supply	Self power supply [X]	Self power supply [X]	Self power supply [X]	
Approvals/Marks	CE - MID - cULus [AV7 only]	CE - MID - cULus [AV7 only]	CE - MID - cULus [AV1 only]	
References				
For ordering key details, please refer to www.productselection.net				

Energy management

Multifunction indicator

Energy transducer

Types

WM12-DIN

ET112

ET340



Dimensions HxWxD (mm)	90 x 108 x 64.5	90 x 36 x 63	90 x 54 x 63
Description	3-phase multifunction power indicator. 6-DIN modules	1-phase energy transducer with wrong connection detection 2-DIN modules	3-phase energy transducer with wrong connection detection 3-DIN modules
Function	System: V_{LL} , V_{LN} , An, VA, V_{Admd} , W_{dmd} , W, var, PF, Hz Max: A, W_{dmd} Single phase: V_{LL} , V_{LN} , A, VA, W, var, PF	V_{LN} , A, Hz, $\pm W$, W_{dmd} , W_{dmd} max, $\pm var$, PF, $\pm kWh$, $\pm kvarh$, kWh+ by tariff (2) TRMS method	System: $\pm kWh$, $\pm kvarh$, kWh+ by tariff (2), V_{LN} , V_{LL} , PF, Hz, $\pm W$, W_{dmd} , W_{dmd} max, $\pm var$, VA Single-phase: kWh, V_{LN} , V_{LL} , A, PF, W, var, VA, THD TRMS method

Input specifications

Range code	400 / 660 V_{LL} / 5(6) AAC [AV5] 100 / 208 V_{LL} / 5(6) AAC [AV6] (current connection by CT)	120 VAC [AV1] 230 VAC [AV0] Ib: 5 A, I _{max} : 100 AAC; 1-phase	3-phase 208-400 V_{LL} AC [AV2] Ib: 5 A, I _{max} : 65 AAC; 3-phase
Accuracy	$\pm 0.5\%$ FS (V, A)	$\pm 0.5\%$ RDG (V, A)	$\pm 0.5\%$ RDG (V, A)
Active energy		Class 1 (EN62053-21)	Class 1 (EN62053-21)
Reactive energy		Class 2 (EN62053-23)	Class 2 (EN62053-23)
Display	LED 3x 3 DGT		

Output specifications

Communication		Modbus RTU [S1]	Modbus RTU [S1]
Inputs	RS485 port (on request) [S]	1 (dual tariff management)	1 (dual tariff management)

General specifications

Power supply	24 VAC [A], 48 VAC [B], 115 VAC [C], 230 VAC [D], 18 to 60 VDC [3]	Self power supply [X]	Self power supply [X]
Approvals/Marks	CE - cULus	CE	CE

References

For ordering key details, please refer to www.productselection.net

Energy management

Multifunction meter

Power analyzers

Types

WM12 96

WM14 Basic/Profibus/Advanced

EM26 96



Dimensions HxWxD (mm)	96 x 96 x 46	96 x 96 x 46 (Panel mounting) 90 x 108 x 64.5 (DIN rail mounting)	96 x 96 x 61
Description	3-phase multifunction power indicator. 96 x 96 panel mounting	3-phase power analyzer 96 x 96 panel mounting or 6-DIN modules	3-phase power analyzer 96 x 96 panel mounting
Function	System: V_{LL} , V_{LN} , A, An, VA, V_{Admd} , W, W_{dmd} , var, PF, Hz Max: A, W_{dmd} Single phase: V_{LL} , V_{LN} , A, VA, W, var, PF	System: kWh, kvarh, V_{LL} , V_{LN} , An, PF, W, var, VA, W_{dmd} , V_{Admd} , Hz, hour meter Max: A, A_{dmd} , W_{dmd} Single phase: V_{LL} , V_{LN} , A, A_{dmd} , PF, W, var, VA, THD (AX) Max: V_{LN} , A, A_{dmd} , W (AX) Min: V_{LN} , A, PF (AX)	System: \pm kWh, \pm kvarh, V_{LL} , V_{LN} , var, VA, W, W_{dmd} , V_{Admd} , VA, PF, Hz, THD, hour counter, gas and water Max: A_{dmd} , W_{dmd} , V_{Admd} Single phase: V_{LL} , V_{LN} , A, W, var, VA, PF, A_{dmd} , kWh, kvarh TRMS method

Input specifications

Range code	400 / 660 V_{LL} AC 5(6) AAC [AV5], 100 / 208 V_{LL} AC 5(6) AAC [AV6] (current connection by CT)	400 / 660 V_{LL} AC 5(6) AAC [AV5], 100 / 208 V_{LL} AC 5(6) AAC [AV6] (current connection by CT)	120 / 208 V_{LL} AC [AV6], 400 / 660 V_{LL} AC [AV5], In: 1 / 5A, I_{max} : 10 AAC
Accuracy	$\pm 0.5\%$ FS (V, A)	$\pm 0.5\%$ FS (V, A)	$\pm 0.5\%$ RDG (V, A)
Active energy		Class 1	Class 1 (EN62053-21) Class B (EN50470-3)
Reactive energy		Class 2	Class 2 (EN62053-23)
Display	LED 3x 3 DGT	LED 3x 3-DGT 8+1 DGT (energies)	LCD backlight 3x 4 DGT (inst. variables) 6+2, 7+1, 8 DGT (energies)

Output specifications

Pulse output		2 open collector [O2AX]	3-open collector [O3] / relay [B2]
Alarm output		2 relays with PLC-type control function on 16 variables (AND / OR) [R2AX]	2-relay [R2] / open collector [O3]
Communication	RS485 port [S]	RS485 port [S] Profibus DP port (on request on 96 model) [DG]	RS485 (2-wire) [S1] M-BUS by means of VMU-B
Inputs			3 digital inputs [I3]

General specifications

Power supply	24 VAC [A], 48 VAC [B], 115 VAC [C], 230 VAC [D], 18 to 60 VDC [3]	24 VAC [A], 48 VAC [B], 115 VAC [C], 230 VAC [D], 18 to 60 VDC [3], 90 to 260 AC/DC [H DG], 18 to 60 VAC/DC [L AX], 90 to 260 VAC/DC [H AX]	90 to 260 VAC/DC [H]
Approvals/Marks	CE - cULus	CE - cULus Advanced version [AX]	CE - cULus - MID



References

For ordering key details, please refer to www.productselection.net

Energy management

Modular power analyzers

Modular power quality analyzers

Types	WM20 96	WM30 96	WM40 96
			
Dimensions HxWxD (mm)	96 x 96 x 50	96 x 96 x 50	96 x 96 x 50
Description	3-phase modular power quality analyzer 96 x 96 panel mounting	3-phase modular power quality analyzer 96 x 96 panel mounting	3-phase modular power quality analyzer 96 x 96 panel mounting
Function	System: total/partial \pm kWh and \pm kvarh, V_{LN} , V_{LL} , VA, W, var, PF, Hz, THD (V,A) Single phase: V_{LN} , V_{LL} , VA, AL, An, W, var, PF, THD Phase-sequence-asymmetry loss	System: total/partial \pm kWh and \pm kvarh, V_{LN} , V_{LL} , VA, W, var, PF, Hz, THD (V,A) Single phase: V_{LN} , V_{LL} , VA, AL, An, W, var, PF, THD Phase-sequence-asymmetry loss	System: Total/partial \pm kWh and \pm kvarh (multi-tariff), V_{LN} , V_{LL} , VA, W, var, PF, Hz, THD, K-factor Single phase: V_{LN} , V_{LL} , VA, AL, An (calculated or measured), W, var, PF, THD, TDD; Phase sequence-asymmetry-loss Load profile, event stamping, data logger, utility and hour counters

Input specifications

Range code	400 / 690 V _{LL} AC 1(2) AAC [AV4] 400 / 690 V _{LL} AC 5(6) AAC [AV5] 100 / 208 V _{LL} AC 5(6) AAC [AV6] 100 / 208 V _{LL} AC 1(2) AAC [AV7]	400 / 690 V _{LL} AC 1(2) AAC [AV4] 400 / 690 V _{LL} AC 5(6) AAC [AV5] 100 / 208 V _{LL} AC 5(6) AAC [AV6] 100 / 208 V _{LL} AC 1(2) AAC [AV7]	400 / 690 V _{LL} AC 1(2) AAC [AV4] 400 / 690 V _{LL} AC 5(6) AAC [AV5] 100 / 208 V _{LL} AC 5(6) AAC [AV6] 100 / 208 V _{LL} AC 1(2) AAC [AV7]
Accuracy	$\pm 0.2\%$ RDG (V, A)	$\pm 0.2\%$ RDG (V, A)	$\pm 0.2\%$ RDG (V, A)
Active energy	Class 0.5S according to EN62053-22	Class 0.5S according to EN62053-22	Class 0.5S according to EN62053-22
Reactive energy	Class 2 according to EN62053-23	Class 2 according to EN62053-23	Class 2 according to EN62053-23
Display	LCD backlight 3x 4 DGT (inst. variables) 8+2, 9+1, 10 DGT (energies)	LCD backlight 4x 4 DGT (inst. variables) 8+2, 9+1, 10 DGT (energies)	LCD backlight 4x 4 DGT (inst. variables) 8+2, 9+1, 10 DGT (energies)

Output specifications

Pulse output	Up to 2 digital outputs	Up to 2 digital outputs	Up to 8 digital outputs
Alarm output	Up to 2 freely configuration virtual alarms	Up to 4 freely configuration virtual alarms	Up to 16 freely configuration virtual alarms
Communication	Optical port Modbus RS485/232 port + RTC [S1], BACnet SMTP [B3], Modbus TCP Ethernet port [E2], BACNet-IP [B1], Profibus [P1]	Optical port Modbus RS485/232 port + RTC [S1], BACnet SMTP [B3], Modbus TCP Ethernet port [E2], BACNet-IP [B1], Ethernet/IP [E6], Profibus [P1]	Optical port Modbus RS485/232 port + RTC [S1], BACnet SMTP [B3], Modbus TCP Ethernet port [E2], BACNet-IP [B1], Ethernet/IP [E6], Profibus [P1]
Analogue output		up to 2	up to 4
Inputs			up to 6 digital inputs



General specifications

Power supply	18 to 60 VAC/DC [L] 90 to 260 VAC/DC [H]	18 to 60 VAC/DC [L] 90 to 260 VAC/DC [H]	18 to 60 VAC/DC [L] 90 to 260 VAC/DC [H]
Approvals/Marks	CE - cULus	CE - cULus	CE - cULus





References

For ordering key details, please refer to www.productselection.net

Energy management

	Modular power quality analyzers		Modular power quality transducer
Types	WM3 96	WM5 96	PQT H
			
Dimensions HxWxD (mm)	96 x 96 x 124	96 x 96 x 124	90 x 90 x 140
Description	3-phase modular power quality analyzer 96 x 96 panel mounting	3-phase modular smart power quality analyzer 96 x 96 panel mounting	3-phase modular smart power quality transducer 96 x 96 DIN rail mounting
Function	System: total/partial \pm kWh, \pm kvarh (4 tariff), V_{LN} , V_{LL} , An, VA, VA_{dmd} , W, W_{dmd} , var, PF, Hz, THD Single phase: V_{LN} , V_{LL} , A, W, var, PF, THD	System: kWh, kvarh, V_{LN} , V_{LL} , An, W, var, VA, PF, Hz Single-phase: V_{LN} , V_{LL} , A, W, var, VA, PF, THD THD and single H up to the 63rd H (V, A)	System: kWh, kvarh, V_{LN} , V_{LL} , An, W, var, VA, PF, Hz Single-phase: V_{LN} , V_{LL} , A, W, var, VA, PF, THD THD and single H up to the 63rd H (V, A)
Input specifications			
Range code	400 VAC-1/5 AAC [AV5] 690 VAC-1/5 AAC [AV7] In: 1/5A, I _{max} : 6 AAC	120/208 V _{LL} [AV6], 400/690 V _{LL} [AV5] In: 1/5A, I _{max} : 10 AAC	120/208 V _{LL} [AV6], 400/690 V _{LL} [AV5] In: 1/5A, I _{max} : 10 AAC
Accuracy	\pm 0.5% RDG (V, A)	\pm 0.2% RDG (V, A)	\pm 0.2% RDG (V, A)
Active energy	Class 1 (kWh)	Class 0.5 (EN62053-22)	Class 0.5 (EN62053-22)
Reactive energy	Class 2 (kvarh)	Class 2 (EN62053-23)	Class 2 (EN62053-23)
	Matrix LCD backlight 4x 4 DGT (instantaneous variables) 4x 7+2, 8+1, 9 DGT (energies)	Matrix LCD backlight 4x 4 DGT (instantaneous variables) 4x 7+2, 8+1, 9 DGT (energies)	
Output specifications			
Pulse output	Up to 2 single / dual open collector or relay modules	Up to 16, by: single / dual or quadruple open collector or relay modules	Up to 16, by: single / dual or quadruple open collector or relay modules
Alarm output	Up to 2 single / dual open collector or relay modules	Up to 16, by: single / dual or quadruple open collector or relay modules	Up to 16, by: single / dual or quadruple open collector or relay modules
Communication	RS 422 / 485 port RS232 port + RTC	RS422 / 485, RS232+RTC modules. Optical port (ANSI C12.18/Modbus) Internet / Ethernet comm. [E2]	RS422 / 485, RS232+RTC modules. Optical port (ANSI C12.18/Modbus) Internet / Ethernet comm. [E2]
Analogue output	Up to 2 single / dual analog output modules	Up to 8, by single / dual (mA/V) output modules	Up to 8, by single / dual (mA/V) output modules
Inputs	Up to 3 digital inputs	Up to 12 (W_{dmd} , VA_{dmd} sync.; tariff, contact status reading)	Up to 12 (W_{dmd} , VA_{dmd} sync.; tariff, contact status reading)
General specifications			
Power supply	18 to 60 VAC/DC [L] 90 to 260 VAC/DC [H]	18 to 60 VAC/DC [L], 90 to 260 VAC/DC [H]	18 to 60 VAC/DC [L], 90 to 260 VAC/DC [H]
Approvals/Marks	CE - cURus - CSA	CE - cURus - CSA	CE - cURus - CSA
References			
For ordering key details, please refer to www.productselection.net			

Energy management

	Compact transducers		DC energy analyzers	
Types	CPT DIN	CPT DIN Advanced	VMU-E	VMU-X
				
Dimensions HxWxD (mm)	83.5 x 45 x 98.5	83.5 x 45 x 98.5	1-DIN module	1-DIN module
Description	3-phase compact power transducer	3-phase compact power transducer	DC energy analyzer: V, A, W, kWh	Power supply module for VMU-E unit
Function	4-digit data format instantaneous variable, 8+1-digit format energy variables, 5+2-digit data format hours TRMS method System: kWh, kvarh, V _{LL} , A _n , PF, W, var, VA, W _{dmd} , VA _{dmd} , Hz, hour meter Max: W _{dmd} Single-phase: V _{LL} , V _{LN} , A, Admd, PF, W, var, VA	4-digit data format instantaneous variable, 8+1-digit format energies, 5+2-digit format hours TRMS method System: kWh, kvarh, V _{LL} , V _{LN} , A _n , PF, W, var, VA, W _{dmd} , VA _{dmd} , Hz, hour Max: W _{dmd} , VA _{dmd} Single-phase: V _{LL} , V _{LN} , A, Admd, PF, W, var, VA, THD, (A, V) Max: V _{LN} , A, Admd, W Min: V _{LN} , A, PF		
Input specifications				
Range code	120 / 208 VAC [AV6], 400 / 690 VAC [AV5], 1 AAC and 5 AAC	120 / 208 VAC [AV6], 400 / 690 VAC [AV5], 1 AAC and 5 AAC	400 VDC 20 ADC [AV00] (up 1000 ADC by external shunt 120 mV) 400 VDC 1000 ADC [AV10] (by 10 VDC current sensor)	
Accuracy	±0.5% RDG (A,V)	±0.5% RDG (A,V)	±0.5% RDG (V, A)	
Active energy	kWh: Class 1	kWh: Class 1 (EN62053-21)	Class 1	
Reactive energy	kvarh: Class 2	kvarh: Class 2 (EN62053-23)		
Display			LCD 6 DGT	
Output specifications				
Pulse output		2 (open collector) [O2]		1 opto-mosfet
Alarm output		2 (relays) with PLC-type control function on 16 variables (AND / OR) [R2]		1 opto-mosfet
Communication	RS422/485 [S1], RS232 [S2]	RS422/485 [S1], RS232 [S2]		RS485 Modbus RTU
Analogue output		Up to 3: 20 mA [A1-3], 10 VDC [V1-3]		
General specifications				
Power supply	18 to 60 VAC/DC [L], 90 to 260 VAC/DC [H]	18 to 60 VAC/DC [L], 90 to 260 VAC/DC [H]	Self power supply through VMU-X unit [X]	38 to 265 VAC/DC [U]
Approvals/Marks	CE - cURus - CSA	CE - cURus - CSA	CE	CE
References				
For ordering key details, please refer to www.productselection.net				

Current transformers

Current transformers

Types	CTD 1Z	CTD 2Z	CTD 3Z
-------	--------	--------	--------



Dimensions HxWxD (mm)	76 x 44 x 31	86 x 56 x 42	99 x 75 x 45
-----------------------	--------------	--------------	--------------

Input specifications

	Current transformer 1-phase AC	Current transformer 1-phase AC	Current transformer 1-phase AC
Operating frequency	48 to 62 Hz	48 to 62 Hz	48 to 62 Hz
Max. system voltage	0.72 kV	0.72 kV	0.72 kV
Rated insulation level	3 kV / 1 min @ 50 Hz	3 kV / 1 min @ 50 Hz	3 kV / 1 min @ 50 Hz
Security factor	≤ 5	≤ 5	≤ 5

Output specifications

Secondary current	5 A	5 A	5 A
-------------------	-----	-----	-----

General specifications

Class	1 / 3	0.5 / 1 / 3	0.5 / 1 / 3
Bus-bar size (mm) [diameter]	[22]	30 x 10 / 25 x 20 [28]	40 x 10 / 30 x 20 / 25 x 25 [33]
Standards	EN 61869-2	EN 61869-2	EN 61869-2

Primary current

	Burden (VA)			Burden (VA)			Burden (VA)					
	Class	0.5	1	3	Class	0.5	1	3	Class	0.5	1	3
Accuracy class depending on the burden of the secondary circuit	50 A			1.5	40 A			2.5	100 A	1.5		
	60 A		1.5		50 A			2.5	150 A	1.5		
	75 A		1.5		100 A	2.5			200 A	1.5		
	80 A		1.5		150 A	2.5			250 A	2.5		
	100 A		2.5		200 A	3.75			300 A	2.5		
	125 A		2.5		250 A	5			400 A	5		
	150 A		2.5		300 A	5			500 A	5		
	200 A		3.75		400 A	5			600 A	5		
	250 A		3.75		500 A	5						
	300 A		3.75		600 A	5						

References

For ordering key details, please refer to www.productselection.net

Current transformers

Current transformers

Types	TADK	TADK2	CTD 1X	CTD 2X
				

Dimensions HxWxD (mm)	115.5 x 75 x 44	115.5 x 75 x 44	66 x 46 x 30	86 x 56 x 42
-----------------------	-----------------	-----------------	--------------	--------------

Input specifications

	Current transformer 1-phase AC	Current transformer 1-phase AC	Current transformer 1-phase AC	Current transformer 1-phase AC
Operating frequency	48 to 62 Hz	48 to 62 Hz	48 to 62 Hz	48 to 62 Hz
Max. system voltage	0.72 kV	0.72 kV	0.72 kV	0.72 kV
Rated insulation level	3 kV/1 min @ 50 Hz	3 kV/1 min @ 50 Hz	3 kV/1 min @ 50 Hz	3 kV/1 min @ 50 Hz
Security factor	≤ 5	≤ 5	≤ 5	≤ 5

Output specifications

Secondary current	5 A standard (1 A on request)	5 A standard (1 A on request)	5 A 1 A	5 A 1 A
-------------------	----------------------------------	----------------------------------	------------	------------

General specifications

Class	0.5	0.5	0.5 / 1 / 3	0.5 / 1 / 3
Bus-bar size (mm) [diameter]	no (wounded primary)	25 x 5 (fixed bar)	20 x 5 [23]	32 x 5 / 30 x 10 / 25 x 20 / 25 x 12 [24]
Standards	IEC 60185	IEC 60185	EN 60044-1, cURus (*)	EN 60044-1, cURus (*)

Primary current

	Burden (VA)				Burden (VA)				Burden (VA)				Burden (VA)			
	Class	0.5	1	3	Class	0.5	1	3	Class	0.5	1	3	Class	0.5	1	3
Accuracy class depending on the burden of the secondary circuit	1 A	10			1 A	10			50 A		1	1.25	40 A			1.25
	5 A	10			5 A	10			60 A		1	1.25	50 A			1.5
	10 A	10			10 A	10			70 A		1.5	1.75	60 A			2
	15 A	10			15 A	10			75 A	1	1.25	1.75	70 A			2.5
	25 A	10			25 A	10			80 A	1.25	1.5	2	75 A		1.75	2.5
	40 A	10			40 A	10			100 A	1.5	1.75	2.25	80 A		2	2.75
					50 A	10			120 A	1.75	2	2.5	100 A		2.5	3
					60 A	10			125 A	2	2.25	2.75	120 A		2.75	3.75
					80 A	10			150 A	2.25	2.5	3	125 A	2	2.75	3.75
					100 A	10			160 A	2.5	2.75	3.25	150 A	3	4	5
					150 A	10			200 A	3	3.25	3.75	160 A	3	4	5
					200 A	10			250 A	4.5	4.75	5.25	200 A	4	5	6.5
					250 A	10			300 A	5	5.5	6	250 A	5.5	7	8
													300 A	7	8.5	9.5
													400 A	12	13.5	14.5
													500 A	14	15.5	16.5
												600 A	17.5	19	20	

References

For ordering key details, please refer to www.productselection.net
 (*) The list of the cURus approved current transformers is available on the datasheets on www.productselection.net

Current transformers

Current transformers

Types	CTD 3X	CTD 4X	CTD 8V CTD 8H	CTD 8Q
-------	--------	--------	------------------	--------

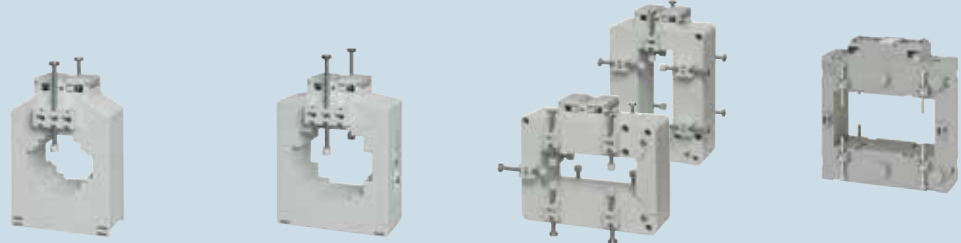

Dimensions HxWxD (mm)	109 x 77 x 42	113 x 90 x 42	133 x 87 x 40 104 x 117 x 40	144 x 129 x 40
-----------------------	---------------	---------------	---------------------------------	----------------

Input specifications

	Current transformer 1-phase AC	Current transformer 1-phase AC	Current transformer 1-phase AC	Current transformer 1-phase AC
Operating frequency	48 to 62 Hz	48 to 62 Hz	48 to 62 Hz	48 to 62 Hz
Max. system voltage	0.72 kV	0.72 kV	0.72 kV	0.72 kV
Rated insulation level	3 kV/1 min @ 50 Hz	3 kV/1 min @ 50 Hz	3 kV/1 min @ 50 Hz	3 kV _{RMS} , 50 Hz, 1 min
Security factor	≤ 5	≤ 5	≤ 5	≤ 5

Output specifications

Secondary current	5 A 1 A	5 A 1 A	5 A 1 A	5 A 1 A
-------------------	------------	------------	------------	------------

General specifications

Class	0.5 / 1 / 3	0.5 / 1 / 3 / 5P5	0.5 / 1 / 3	0.5
Bus-bar size (mm) [diameter]	51 x 15 / 40 x 20 / 32 x 32 / 40 x 20 [41]	64 x 20 / 51 x 43 / [51]	80 X 30	55 x 100
Standards	EN 60044-1, cURus (*)	EN 60044-1, cURus (*)	EN 60044-1, cURus (*)	EN 60044-1

Primary current





	Burden (VA)			Burden (VA)			Burden (VA)			Burden (VA)					
	Class	0.5	1	3	Class	0.50	1	3	Class	0.5	1				
Accuracy class depending on the burden of the secondary circuit	50 A			1.75	150 A			2.5	5	150 A		2	1000 A	15	
	60 A			2	200 A			3.25	6	200 A		4	1500 A	15	
	70 A			2.25	250 A	2.5	4.5			250 A		5	2000 A	15	
	75 A			3	300 A	3	4			300 A		2	6	2500 A	15
	80 A			3	400 A	6	9			400 A	3	5	8	3000 A	15
	100 A		2	3.5	500 A	10	12.5			500 A	5	7	10	4000 A	15
	120 A		2.25	4	600 A	11	13.5			600 A	6	10	12		
	125 A		2.5	4.5	700 A	12.5	15			700 A	6	10	12		
	150 A	2.25	3	6	750 A	13	15.5			750 A	8	12	15		
	160 A	2.5	3.5	6.5	800 A	14	16.5			800 A	8	12	15		
	200 A	3	4.5	8.5	1000 A	17.5	20			1000 A	10	15	20		
	250 A	3.5	6.5	10.5	1200 A	20	22.5			1200 A	12	15	20		
	300 A	7	10	13	1250 A	20	22.5			1250 A	12	15	20		
	400 A	9	14	17	1500 A	27.5	30			1500 A	15	20	25		
	500 A	14	18	21	1600 A	27.5	30			1600 A	15	20	25		
	600 A	17	21	24						2000 A	20	25	30		
700 A	22	26	29						2500 A	25	30	40			
750 A	24	28	31												
800 A	25	29	32												

References

For ordering key details, please refer to www.productselection.net
 (*) The list of the cURus approved current transformers is available on the datasheets on www.productselection.net

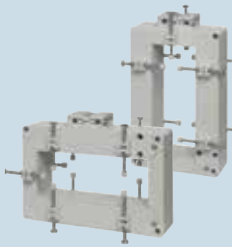
Current transformers

Current transformers

Types	CTD 9V CTD 9H	CTD 10V CTD 10H	CTD 11V CTD 11H	CTD 12V CTD 12H
				
Dimensions HxWxD (mm)	178 x 92 x 40 109 x 162 x 40	178 x 107 x 40 124 x 162 x 40	178 x 98 x 40 115 x 160 x 40	178 x 125 x 40 140 x 157 x 40

Input specifications

	Current transformer 1-phase AC	Current transformer 1-phase AC	Current transformer 1-phase AC	Current transformer 1-phase AC
Operating frequency	48 to 62 Hz	48 to 62 Hz	48 to 62 Hz	48 to 62 Hz
Max. system voltage	0.72 kV	0.72 kV	0.72 kV	0.72 kV
Rated insulation level	3 kV / 1 min @ 50 Hz	3 kV / 1 min @ 50 Hz	3 kV _{RMS} , 50 Hz	3 kV _{RMS} , 50 Hz
Security factor	≤ 5	≤ 5	≤ 5	≤ 5

Output specifications

Secondary current	5 A 1 A	5 A 1 A	5 A 1 A	5 A 1 A
-------------------	------------	------------	------------	------------

General specifications

Class	0.5 / 1 / 3	0.5 / 1 / 3	0.5	0.5
Bus-bar size (mm)	125 x 35	125 x 50	125 x 37	125 x 53
Standards	EN 60044-1, cURus (*)	EN 60044-1, cURus (*)	EN 60044-1	EN 60044-1

Primary current

	Burden (VA)			Burden (VA)			Burden (VA)		Burden (VA)	
	Class	0.5	1	3	Class	0.50	1	3	Class	0.5
Accuracy class depending on the burden of the secondary circuit	400 A		3	6	400 A	1	7	10	1000 A	15
	500 A	2	4	8	500 A	3	10	14	1500 A	15
	600 A	4	6	10	600 A	5	12	17	2000 A	15
	700 A	4	8	10	700 A	8	15	20	2500 A	15
	750 A	4	8	10	750 A	10	15	20	3000 A	15
	800 A	4	8	10	800 A	10	15	20	4000 A	15
	1000 A	6	10	13	1000 A	12	20	25		
	1200 A	8	12	15	1200 A	15	25	30		
	1250 A	8	12	15	1250 A	15	25	30		
	1500 A	10	15	18	1500 A	20	30	40		
	1600 A	10	15	18	1600 A	20	30	40		
	2000 A	15	20	24	2000 A	25	40	50		
	2500 A	20	25	30	2500 A	30	50	60		
	3000 A	25	30	35	3000 A	30	50	60		
	3200 A	25	30	35	3200 A	30	50	60		

References

For ordering key details, please refer to www.productselection.net
 (*) The list of the cURus approved current transformers is available on the datasheets on www.productselection.net

Current transformers

Split core current transformers

Types

CTD 5S

CTD 6S

CTD 8S

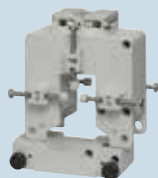

Dimensions HxWxD (mm)

94 x 83 x 40

114 x 107 x 40

133 x 87 x 40

Input specifications

	Split core current transformer 1-phase AC	Split core current transformer 1-phase AC	Split core current transformer 1-phase AC
Operating frequency	48 to 62 Hz	48 to 62 Hz	48 to 62 Hz
Max. system voltage	0.72 kV	0.72 kV	0.72 kV
Rated insulation level	3 kV _{RMS} , 50 Hz, 1 min	3 kV _{RMS} , 50 Hz, 1 min	3 kV _{RMS} , 50 Hz, 1 min
Security factor	≤ 5	≤ 5	≤ 5

Output specifications

Secondary current	5 A 1 A	5 A 1 A	5 A 1 A
-------------------	------------	------------	------------

General specifications

Class	1	1	1
Bus-bar size (mm)	27 x 32	52 x 51	81 x 31
Standards	EN 60044-1, cURus (*)	EN 60044-1, cURus (*)	EN 60044-1, cURus (*)

Primary current

	Burden (VA)			Burden (VA)			Burden (VA)		
	Class	1	3	Class	1	3	Class	1	3
100 A			1.5	150 A		1.5	150 A		1.5
125 A	1.5	1.5		200 A	1.5	2	200 A		1.5
150 A	1.5	2.5		250 A	1.5	3.75	250 A		2
200 A	1.5	5		300 A	1.5	5	300 A		2
250 A	1.5	5		400 A	2.5	5	400 A	3	5
300 A	2.5	7.5		500 A	5	10	500 A	5	7
400 A	5	10		600 A	7.5	15	600 A	6	10
				700 A	7.5	15	700 A	6	10
				750 A	7.5	15	750 A	8	12
				800 A	10	15	800 A	8	12
				1000 A	10	15	1000 A	10	15
							1200 A	12	15
							1250 A	12	15
							1500 A	15	20
							1600 A	15	20
							2000 A	20	25
							2500 A	25	30

Accuracy class depending on the burden of the secondary circuit

References

For ordering key details, please refer to www.productselection.net
 (*) The list of the cURus approved current transformers is available on the datasheets on www.productselection.net

Current transformers

Split core current transformers Active current sensor

Types CTD 9S CTD 10S ROG 400

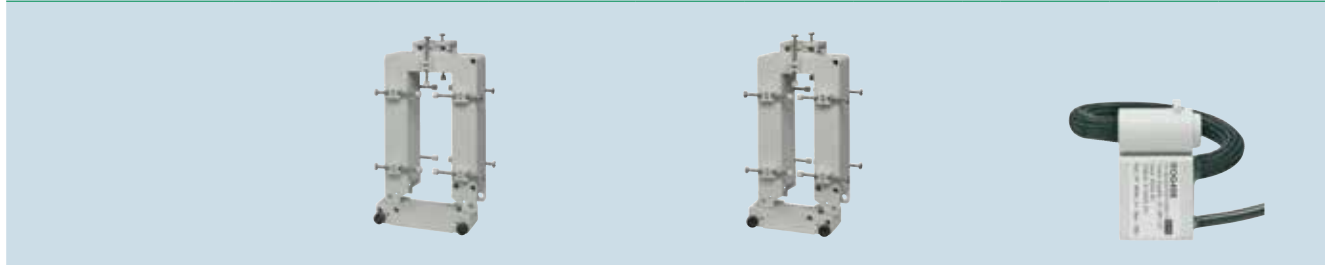

Dimensions HxWxD (mm)	178 x 92 x 40	178 x 107 x 40	54 x 29 x 17
-----------------------	---------------	----------------	--------------

Input specifications

	Split core current transformer 1-phase AC	Split core current transformer 1-phase AC	Split core AC current sensor 1-phase AC
Operating frequency	48 to 62 Hz	48 to 62 Hz	45 to 65 Hz
Max. system voltage	0.72 kV	0.72 kV	
Rated insulation level	3 kV _{RMS} , 50 Hz, 1 min	3 kV _{RMS} , 50 Hz, 1 min	3 kV _{RMS} , 50 Hz
Security factor	≤ 5	≤ 5	

Output specifications

Secondary current	5 A 1 A	5 A 1 A	4 to 20 mA DC
-------------------	------------	------------	---------------

General specifications

Class	1	1	
Bus-bar size (mm) [diameter]	125 x 35	125 x 50	[40]
Standards	EN 60044-1, cURus (*)	EN 60044-1, cURus (*)	

Primary current

	Burden (VA)			Burden (VA)		
	Class	1	3	Class	1	3
400 A			3	400 A	1	7
500 A	2		4	500 A	3	10
600 A	4		6	600 A	5	12
700 A	4		8	700 A	8	15
750 A	4		8	750 A	10	15
800 A	4		8	800 A	10	15
1000 A	6		10	1000 A	12	20
1200 A	8		12	1200 A	15	25
1250 A	8		12	1250 A	15	25
1500 A	10		15	1500 A	20	30
1600 A	10		15	1600 A	20	30
2000 A	15		20	2000 A	25	40
2500 A	20		25	2500 A	30	50
3000 A	25		30	3000 A	30	50
3200 A	25		30	3200 A	30	50

Accuracy class depending on the burden of the secondary circuit

400 AAC

References

For ordering key details, please refer to www.productselection.net
 (*) The list of the cURus approved current transformers is available on the datasheets on www.productselection.net

Current transformers

Split core and Rogowski current sensors for EM210_MV

Types

CTV-1X

CTV-2X

CTV-3X



Input / output specifications

Primary current 50/60 Hz	60 A (1-70 A)	100 A (1-120 A)	200 A
Secondary output	333 mV	333 mV	333 mV

General specifications

Accuracy	1%	1%	1%
Linearity	0.5%	0.5%	0.5%
Phase error at nominal current	≤4°	≤2°	≤2°
Max. system voltage	660 V	660 V	660 V
Opening angle	180°	180°	180°
Certifications	CE - cURus	CE - cURus	CE - cURus

References

CTV1X60A333MV

CTV2x100A333MV

CTV3X200A333MX

Types

CTV-4X

CTV-8X

ROG4K

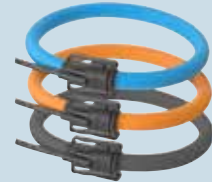

Input / output specifications

Primary current 50/60 Hz	400 A (20-480 A max)	800 A (1-1000 A max)	4000 A
Secondary output	333 mV	333 mV	

General specifications

Accuracy	1%	1%	1%
Linearity	0.5%		
Phase error at nominal current	≤2°	≤2°	
Max. system voltage	660 V	660 V	600V (cat III)
Opening angle	180°		
Coil length			400, 600 or 900 [XXX]
Certifications	CE - cURus	CE - cURus	CE - cURus

References





CTV4X400A333MV

CTV8X800A333MV

ROG4K1002M [XXX] 3X

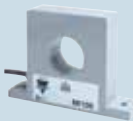
Current transformers

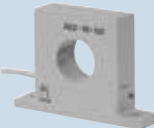
Current transformers for monitoring relays

Types	MI	MP	A 82	E 83
				
Dimensions HxWxD (mm)	45 x 52 x 16 [5 / 20] 67.5 x 95 x 20 [100 / 500]	45 x 120 x 16 [5 / 20] 114 x 150 x 23 [100 / 500]	67.5 x 95 x 20	56 x 22.5 x 49
Function	1-phase AC. Output voltage. Cable hole.	3-phase AC. Output voltage. Cable hole.	1-phase AC. Output 0 / 4-20 mA DC, 0-10 VDC (A82-30). Cable hole. Led indication.	1-phase AC. Output 4-20 mA DC. Cable hole. DIN-rail mounting.

Input specifications

Input current	0.5 - 5 AAC [5] 2 - 20 AAC [20] 10 - 100 AAC [100] 50 - 500 AAC [500]	0.5 - 5 AAC [5] 2 - 20 AAC [20] 10 - 100 AAC [100] 50 - 500 AAC [500]	0 - 25 AAC [25] 0 - 50 AAC [50] 0 - 100 AAC [100] 0 - 250 AAC [250] 0 - 500 AAC [500]	0 - 5 AAC 0 - 10 AAC 0 - 15 AAC 0 - 20 AAC 0 - 25 AAC 0 - 30 AAC 0 - 50 AAC
Max. current continuously	20 AAC [5] 50 AAC [20] 250 AAC [100] 750 AAC [500]	20 AAC [5] 50 AAC [20] 250 AAC [100] 750 AAC [500]	600 AAC	100 AAC
Dielectric voltage	6 kV ACrms	6 kV ACrms	6 kV ACrms	

Output specifications

Output value	0.4 - 4 Vp The output voltage is proportional to the input current	0.4 - 4 Vp The output voltage is proportional to the highest current value in the 3 conductors which are drawn through the holes of the current metering transformer	A82 - 10: 0-20 mA DC A82 - 20: 4-20 mA DC A82 - 30: 0-10 VDC The output current (A82-10, A82-20) and voltage (A82-30) are proportional to the input current	4 - 20 mA DC The output current is proportional to the input current
Output tolerance	± 5% @ In	± 5% @ In	± 2% @ 50 Hz	± 2% @ 50 Hz
Rated insulation voltage (cable)	250 VACrms	250 VACrms	250 VACrms	



General specifications

Cable hole diameter	10.5 mm [5 / 20] 27 mm [100 / 500]	3 x 12 mm [5 / 20] 3 x 27 mm [100 / 500]	27 mm	12 mm
Connection cable	2 m PVC 2 x 0.5 mm ²	2 m PVC 2 x 0.5 mm ²	A82-10, A82-30: 2 m, 3x0.25 m ² A82-20: 2 m, 2x0.25 m ²	Screw terminal 2 x 1.5 mm ²
Operating temperature	-20°C to +60°C	-20°C to +60°C	-20°C to +50°C	-20°C to +50°C



References

	MI 5	MP 3005	A 82-XX 25	E 83-20 50
	MI 20	MP 3020	A 82-XX 50	
	MI 100	MP 3100	A 82-XX 100	
	MI 500	MP 3500	A 82-XX 250	
			A 82-XX 500	
			XX = 10: 0-20 mA DC = 20: 4-20 mA DC = 30: 0-10 VDC	



Energy monitoring solution

	Aggregation server	Aggregation server
Types	Em ² -Server	VMU-Y EM
		
Dimensions		2-DIN module
Description	Em ² -Server is a cloud solution capable of aggregating information from up to 100 installations powered by VMU-C EM units. Data from the plants are transmitted through Internet, stored inside the embedded database and presented by the integrated web interface. Em ² -Server + VMU-C EM is a solid, reliable and plug'n play architecture aimed at managing multiple sites projects	VMU-Y EM is an embedded solution capable of aggregating information from up to 10 installations powered by VMU-C EM units. Data from the plants are transmitted through Internet, stored inside the embedded database and presented by the integrated web interface. VMU-Y EM + VMU-C EM is a solid, reliable and plug'n play architecture aimed at managing multi-site installations
Type	Virtual Machine Software	Micro PC
Storage memory		32 GB
Back-up memory		Micro-SD / Micro-SDHC / USB
Compatibility		
Host Operating System	Operating system compatible with VMWARE 64 bit technology	
Virtual Machine Compatibility	VMWARE 64 bit	
Hardware compatibility	64 bit architecture compatible with VMWARE 64 bit	
Cloud compatibility	Hosting providers compatible with VMWARE technology	
Software/Firmware specification		
Data acquisition	By means of Carlo Gavazzi's DP (Data push) protocol	By means of Carlo Gavazzi's DP (Data push) protocol
Integrated operating system	64 bit Linux	Embedded Linux
Integrated Data Base	Industrial class SQL relational database	Industrial class SQL relational database
User Interface	Integrated multi-user, multilingual web interface	Integrated multi-user, multilingual web interface
LED		
Status and colour	One led with different colors for modem communication, data synchronization, alarms and power supply	
Communication port and Output specifications		
Ethernet	1 port for Internet / LAN connection	
USB	1 USB "A" (for USB stick) and 1 USB "mini-A" (service port)	
Connections		
Ethernet	RJ-45 connector (10 / 100 Base-T)	
USB	High Speed USB 2.0	
General specifications		
Managed VMU-C PV units	From 20 to 100	Up to 10
Software installation	By DVD containing the Em ² -Server Virtual machine	
Licensing	Perpetual license based on connected VMU-C EM units	
Voltage supply	From 12 to 28 VDC	
Power consumption	≤ 5 W	
Approvals/Marks	CE - cULus listed	
References		
For ordering key details, please refer to www.productselection.net		



Energy monitoring solution

	Web-server	USB dongle connection module
Types	VMU-C EM	VMU-D
		
Dimensions HxWxD (mm)	2-DIN module	2-DIN module
Description	Web-server which controls and supervises any electrical installation acquiring information from energy meters, power analyzers and VMU I/O modules. It provides information via Internet, so data are available anywhere	Accessory module for connecting third party USB dongle modems (3G or 4G) approved by Carlo Gavazzi to VMU-C or VMU-Y systems
Type	Micro PC	USB dongle connection module
Storage memory	4 GB	
Back-up memory	Micro-SD / Micro-SDHC / USB	
Mobile communication specifications		
SIM card		Depending on the modem unit
Compatibility		Compatible with USB modems (3G or 4G) approved by Carlo Gavazzi
Supported services		Internet communication; SMS
LED		
Status and colour	One LED with different colours for internal BUS communication, communication ports, alarms and power supply	Single colour green for power supply status
Communication port and Output specifications		
RS485	1 port for VMU I/O modules, 1 port for power analyzers and energy meters	
Ethernet	1 port for Internet / LAN connection	
USB	1 USB "A" (for USB stick) and 1 USB "mini-A" (service port)	1 USB "A" (for USB dongle modem connection)
Antenna		
Connector		Depending on the modem unit
Type		Depending on the modem unit
Connections		
RS485	3 screw terminals per port	
Ethernet	RJ-45 connector (10 / 100 Base-T)	
USB	High Speed USB 2.0	
General specifications		
Voltage supply	From 12 to 28 VDC	From 12 to 28 VDC
Power consumption	≤ 5 W	IN/OUT connection to supply also the VMU-C / VMU-Y unit; consumption depending on the connected optional modules (range: from 8.6 W to 18.6 W)
Approvals/Marks	CE - cULus listed	CE - cULus listed
References		
For ordering key details, please refer to www.productselection.net		

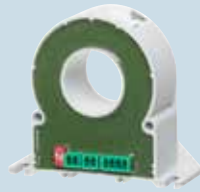

Energy monitoring solution

	VMU I/O optional modules			Contactless power analyzers
Types	VMU-M EM	VMU-P EM	VMU-O EM	CPA
				
Dimensions	1-DIN module	1-DIN module	1-DIN module	CPA050 63x46x25 (without connectors) CPA0300 99x89x30 (without connectors)
Description	Master unit 6-DGT readout	Environment variable measurement unit	Inputs / outputs unit	Contactless power analysers
Function	VMU-M performs the local bus management of VMU-P both measuring units and VMU-O I/O unit	2 temperatures, 1 analogue and 1 pulse rate output	VMU-O allows to add, for every single unit, available in the local bus two digital inputs and two relay outputs	CPA monitors electrical variables (V,A,W, var, VA, kWh, PF, HZ, THD) in 1-phase AC (from 1 to 400 Hz) or DC systems
Input specifications				
Range code	2 Pt100 or Pt1000, 3-wires (-50.0 to +200.0°C) or one digital input and one pulse input, for local management	2 Pt100 or Pt1000, 3-wires 1 analogue input (20 mA or 120 mV). 1 pulse rate input (0 to 1000 Hz max.) [2TIW]	2 digital inputs for "Protection trip detection or others"	One current input (Hall effect): 50AAC/50ADC (CPA050) or 300AAC/400ADC(CPA300) One voltage input: 800VAC/1000VDC
Accuracy	±(0.5%RDG + 5DGT)	±(0.2%RDG + 1DGT)		±(0.5%F.S.) for V,A,W
Output specifications				
Alarm	Real and virtual alarm management of all variables coming from VMU-M and VMU-P with local event logging		2 digital outputs for alarm notification of local alarms or as a digital input status changing. SPST relay type	Virtual alarm detection of voltage over-range and current over-range
Serial communication	Local bus: up to 1 VMU-P and 3 VMU-O units RS485 communication port (Modbus)	Local bus: one VMU-P unit per bus	Local bus: up to 3 VMU-O units	RS485 communication port (Modbus)
Others		Front multicolour LED to show the status of the unit	Front multicolour LED to show the status of the unit	Front LED to show the Power- ON status of the device
General specifications				
Power supply	12 to 28 VDC power supply	Self-power supply from VMU-M unit	Self-power supply from VMU-M unit	9 to 30 VDC power supply
Approvals/Marks	cULus approved	cULus approved	cULus approved	CE
References				
For ordering key details, please refer to www.productselection.net				

PV monitoring solution



Aggregation server		Aggregation server
Types	Eos-Server	VMU-Y PV
		
Dimensions		2-DIN module
Description	<p>Eos-Server is a cloud solution capable of aggregating information from up to 100 PV plants powered by VMU-C PV units. Data from the plants are transmitted through Internet, stored inside the embedded database and presented by the integrated web interface. Eos-Server + VMU-C PV is a solid, reliable and plug'n play architecture aimed at managing portfolios of plants</p>	<p>VMU-Y PV is an embedded solution capable of aggregating information from up to 10 PV plants powered by VMU-C PV units. Data from the plants are transmitted through Internet, stored inside the embedded database and presented by the integrated web interface. VMU-Y PV + VMU-C PV is a solid, reliable and plug'n play architecture aimed at managing portfolios of plants</p>
Type	Virtual Machine Software	Micro PC
Storage memory		32 GB
Back-up memory		Micro-SD / Micro-SDHC / USB
Compatibility		
Host operating system	Operating system compatible with VMWARE 64 bit technology	
Virtual machine compatibility	VMWARE 64 bit	
Hardware compatibility	64 bit architecture compatible with VMWARE 64 bit	
Cloud compatibility	Hosting providers compatible with VMWARE technology	
Software/Firmware specification		
Data acquisition	By Means of Carlo Gavazzi's DP protocol	By Means of Carlo Gavazzi's DP (Data push) protocol
Integrated operating system	64 bit Linux	Embedded Linux
Integrated Data Base	Industrial class SQL relational database	Industrial class SQL relational database
User Interface	Integrated multi-user, multilingual web interface	Integrated multi-user, multilingual web interface
LED		
Status and colour	One led with different colors for modem communication, data synchronization, alarms and power supply	
Communication port and Output specifications		
Ethernet	1 port for Internet / LAN connection	
USB	1 USB "A" (for USB stick) and 1 USB "mini-A" (service port)	
Connections		
Ethernet	RJ-45 connector (10 / 100 Base-T)	
USB	High Speed USB 2.0	
General specifications		
Managed VMU-C PV units	From 20 to 100	Up to 10
Software installation	By DVD containing the Eos-Server Virtual machine	
Licensing	perpetual license based on connected VMU-C PV units	
Voltage supply	From 12 to 28 VDC	
Power consumption	≤ 5 W	
Approvals/Marks	CE - cULus listed	
References		
For ordering key details, please refer to www.productselection.net		

PV monitoring solution

	Web-server	USB dongle connection module
Types	VMU-C PV	VMU-D
		
Dimensions HxWxD (mm)	2-DIN module	2-DIN module
Description	VMU-C is a Web-server which controls and supervises a photovoltaic installation acquiring information from Eos-Array groups, inverters and energy meters. The VMU-C provides information via Internet so data are available wherever you are. VMU-C is also capable of M2M communication by scheduling FTP uploads or by interacting with its HTTP API.	Accessory module for connecting third party USB dongle modems (3G or 4G) approved by Carlo Gavazzi to VMU-C or VMU-Y systems
Type	Micro PC	USB dongle connection module
Storage memory	4 GB	
Back-up memory	Micro-SD / Micro-SDHC / USB	
Mobile communication specifications		
SIM card		Depending on the modem unit
Compatibility		Compatible with USB modems (3G or 4G) approved by Carlo Gavazzi
Supported services		Internet communication; SMS
LED		
Status and colour	One led with different colors for internal BUS communication, communication ports, alarms and power supply	Single colour green for Power supply status
Communication port and Output specifications		
RS485	1 port for Eos-Arrays, 1 port for inverters and energy meters	
Ethernet	1 port for Internet / LAN connection	
USB	1 USB "A" (for USB stick) and 1 USB "mini-A" (service port)	1 USB "A" (for USB dongle modem connection)
Antenna		
Connector		Depending on the modem unit
Type		Depending on the modem unit
Connections		
RS485	3 screw terminals per port	
Ethernet	RJ-45 connector (10 / 100 Base-T)	
USB	High Speed USB 2.0	
General specifications		
Voltage supply	From 12 to 28 VDC	From 12 to 28 VDC
Power consumption	≤ 5 W	IN/OUT connection to supply also the VMU-C / VMU-Y unit; consumption depending on the connected optional modules (range: from 8.6W to 18.6W)
Approvals/Marks	CE - cULus listed	CE - cULus listed
References		
For ordering key details, please refer to www.productselection.net		

PV monitoring solution

EOS-Array solar control solution

Types	VMU-M	VMU-S	VMU-P
			
Dimensions HxWxD (mm)	1-DIN module	1-DIN module	1-DIN module
Description	Master unit 6-DGT readout	String unit, with built-in protection fuseholder	Environment variable measurement unit
Function	VMU-M performs the local bus management of VMU-S, VMU-P both measuring units and VMU-O I/O unit	Variables measuring unit, DC current, voltage, power and energy metering. String control and efficiency measurement	PV module temperature, air temperature, sun irradiation and wind speed metering
Input specifications			
Range code	2 Pt100 or Pt1000, 3-wire (-50.0°C to +200.0°C) or one digital input and one pulse input. [T2]	Direct connections 16 A / 1000 VDC [AV10]. Measurements: V, A, W, Wh	2 Pt100 or Pt1000, 3-wire (PV and air temperature). 1 irradiance input (up to 120 mV [2TIW] or 4-20 mA [2TCW]). 1 wind speed input (0 to 1000 Hz max.)
Accuracy	±(0.5% RDG + 5DGT)	±(0.5% RDG + 2DGT)	±(0.2% RDG + 1DGT)
Output specifications			
Alarm	Real and virtual alarm management of all variables coming from VMU-M, VMU-S, and VMU-P with event logging		
Serial communication	Local bus: up to 15 mixed VMU-S, VMU-P and VMU-O units RS485 communication port (Modbus) [S1]	Local bus: up to 15 VMU-S units in the same bus [S]	Local bus: one VMU-P unit per bus [S]
Others	Data logger (V, A, W, PV cell and air temperature, irradiation, wind speed) DC/AC efficiency	Diagnostics functions: antitheft control, fuse blow detection, wrong PV panel connection. Front multicolour LED to show the status of the unit	Front multicolour LED to show the status of the unit
General specifications			
Power supply	12 to 28 VDC power supply [A]	Self-power supply from VMU-M unit [X]	Self-power supply from VMU-M unit [X]
Approvals/Marks	CE - cULus Listed	CE - cULus Listed	CE - cULus Listed
References			
For ordering key details, please refer to www.productselection.net			

PV monitoring solution

EOS-Array solar control solution

Types

VMU-O...AT

VMU-AT



Dimensions HxWxD (mm)	1-DIN module	1-DIN module
Description	Inputs/outputs unit	Optical fiber anti-theft sensor
Function	VMU-O allows to add, for every single unit, available in the local bus two digital inputs and two relay outputs. Optical fiber anti-theft alarm [I3R1AT] with VMU-AT module	Optical fiber interruption alarm. Up to 200 m lenght of optical fiber loop

Input specifications

Range code	2 digital inputs for "Protection trip detection or others" [I2]	Optical fiber plastic type PF0221000
------------	---	--------------------------------------

Output specifications

Alarm	2 digital outputs for alarm notification as string alarm or as a digital input status changing. SPST relay type. [R2]	NPN or PNP
Serial communication	Local bus: up to 7 VMU-O units	
Others	Front multicolour LED to show the status of the unit	

General specifications



Power supply	Self-power supply from VMU-M unit [X]	Self power supply through VMU-O AT unit [X]
Approvals/Marks	CE - cULus Listed	CE

References

For ordering key details, please refer to www.productselection.net



PV monitoring solution

EOS-Array Lite solar control solution

Types	VMU-ML	VMU-S0	VMU-P
			
Dimensions HxWxD (mm)	1-DIN module	1-DIN module	1-DIN module
Description	Master unit 6-DGT readout	String unit, with built-in protection fuseholder	Environment variable measurement unit
Function	VMU-ML performs the local bus management of VMU-S0, VMU-P both measuring units and VMU-O output unit	Variables measuring unit, DC current and voltage	PV module temperature, air temperature, sun irradiation
Input specifications			
Range code		Direct connections 16 A / 1000 VDC [AV10]. Measurements: V, A	1 Pt100 or Pt1000, 3-wire (PV and air temperature). 1 irradiation input (up to 120 mV [1TI] or 4 - 20 mA [2TCW])
Accuracy		±(0.5%RDG + 2DGT)	±(0.2%RDG + 1DGT)
Output specifications			
Alarm	Single real or virtual alarm management of all variables coming from VMU-ML, VMU-S0, and VMU-P with event logging		
Serial communication	Local bus: up to 15 mixed VMU-S0, VMU-P and VMU-O units RS485 communication port (Modbus) [S1]	Local bus: up to 15 VMU-S0 units in the same bus [S]	Local bus: one VMU-P unit per bus [S]
Others	Front dual colour LED to show the status of the unit	Diagnostics functions: wrong PV panel connection	Front multicolor LED to show the status of the unit
General specifications			
Power supply	12 to 28 VDC power supply [A]	Self-power supply from VMU-ML unit [X]	Self-power supply from VMU-ML unit [X]
Approvals/Marks	CE - cULus Listed	CE - cULus Listed	CE - cULus Listed
References			
For ordering key details, please refer to www.productselection.net			

Monitoring relays

Current relays

Types	DIA 01 PIA 01	DIA 53	DIB 01 PIB 01
			
Dimensions HxWxD (mm) DIN RAIL housing Plug-in housing	80 x 22.5 x 99.5 [D] 80 x 36 x 94 [P]	81 x 17.5 x 67.2 [Mini-D]	80 x 22.5 x 99.5 [D] 80 x 36 x 94 [P]
Function	Over current monitoring relay. 1-phase AC / DC. Direct input or on CT 5A. Setpoint adjustable. Hysteresis adjustable.	Over current monitoring relay. 1-phase AC. Setpoint adjustable. 2-wire connection. Reaction time < 50 ms for F versions. 12 mm hole for insulated current carrying wire.	Over or under current monitoring relay. 1-phase AC / DC TRMS. Direct input or on CT 10A. Setpoint adjustable. Hysteresis adjustable. Delay time adjustable. 12 mm hole for insulated current carrying wire [100 A].

Input specifications

Measuring range	0.5 - 5 AAC/DC	2 - 20 AAC [20A] 5 - 50 AAC [50A] 10 - 100 AAC [100A]	0.1 - 5 mAAC/DC [5 MA] 1 - 50 mAAC/DC [50 MA] 10-500 mAAC/DC [500 MA] 0.1-5 AAC/DC [5 A] 1-10 AAC/DC [10 A] 2-100 AAC [100 A]
-----------------	----------------	---	--

Output specifications

	1 x SPDT relay	Static output	1 x SPDT relay
Max. load AC1	8 A / 250 VAC		8 A / 250 VAC
Max. load DC12	5 A / 24 VDC	100 mA	5 A / 24 VDC
Electrical life	>1 x 10 ⁵ operations		>1 x 10 ⁵ operations



General specifications

Power supply	24-48 VAC/DC [D48] 115 / 230 VAC [B23]	40 VDC max. Powered by the measured current	24-48 VAC/DC [D48] 115 / 230 VAC [B23] 24 VDC / 24-240 VAC [M24]
Approvals/Marks	CE - UL - CSA	CE - UL - CSA	CE - UL - CSA

References





DIA01C D48 5A	DIA53S 724 20A	DIB01C ... 5MA
PIA01C D48 5A	DIA53S 724 50A	DIB01C ... 50MA
DIA01C B23 5A	DIA53S 724 100A	DIB01C ... 500MA
PIA01C B23 5A	DIA53S 724 20A F	DIB01C ... 5A
	DIA53S 724 50A F	DIB01C ... 10A
	DIA53S 724 100A F	DIB01C M24 100A
		PIB01C ... 5MA
		PIB01C ... 50MA
		PIB01C ... 500MA
		PIB01C ... 5A
		PIB01C ... 10A
		... = insert code for Power Supply

Monitoring relays

Current relays			
Types	DIB 71	DIB 02 PIB 02	DIC 01 PIC 01
			
Dimensions HxWxD (mm)	81 x 35.5 x 67.2 [Mini-D]	80 x 22.5 x 99.5 [D] 80 x 36 x 94 [P]	80 x 45 x 99.5 [D] 80 x 36 x 94 [P]
DIN RAIL housing			
Plug-in housing			
Function	Over or under current monitoring relay. 1-phase AC/DC TRMS. Direct input or on CT 5 A. Setpoint adjustable. Hysteresis adjustable. Delay time adjustable.	Over or under current monitoring relay. 1-phase AC/DC TRMS. Input on shunt or CT MI / MP. Setpoint adjustable. Hysteresis adjustable. Delay time adjustable.	Process signal monitoring relay. 1-phase AC/DC TRMS. Direct input, CT A82 or CT MI / MP. 2 setpoints separately adjustable. Hysteresis adjustable. 2 delay functions separately adjustable.
Input specifications			
Measuring range	0.1 - 5 mAAC/DC [5MA] 1 - 50 mAAC/DC [50MA] 10 - 500 mAAC/DC [500 MA] 0.1 - 5 AAC/DC [5A]	6 - 150 mVAC/DC 0.4 - 4 V _P	0.5 - 20 mAAC/DC 0.1 - 10 VAC/DC 0.4 - 4 V _P
Output specifications			
	1 x SPDT relay	1 x SPDT relay	1 x SPDT relay [P] 2 x SPDT relays [D]
Max. load AC1	5 A / 250 VAC	8 A / 250 VAC	5 A / 250 VAC
Max. load DC12	5 A / 24 VDC	5 A / 24 VDC	5 A / 24 VDC
Electrical life	>1 x 10 ⁵ operations	>1 x 10 ⁵ operations	>1 x 10 ⁵ operations
General specifications			
Power supply	24 / 48 VAC [B48] 115 / 230 VAC [B23]	24 - 48 VAC/DC [D48] 115 / 230 VAC [B23]	24 - 48 VAC/DC [D48] 115 / 230 VAC [B23]
Approvals/Marks	CE - UL - CSA	CE - UL - CSA	CE - UL - CSA
References			
	DIB71C B48 5MA	DIB02C D48 150MV	DIC01D D48 AV0
	DIB71C B48 50MA	PIB02C D48 150MV	PIC01C D48 AV0
	DIB71C B48 500MA	DIB02C B23 150MV	DIC01D B23 AV0
	DIB71C B48 5A	PIB02C B23 150MV	PIC01C B23 AV0
	DIB71C B23 5MA		
	DIB71C B23 50MA		
	DIB71C B23 500MA		
	DIB71C B23 5A		





Monitoring relays

Voltage relays

Types	DUA 01 PUA 01	DUA 52	DUA 55	DUB 01 PUB 01
				
Dimensions HxWxD (mm) DIN RAIL housing Plug-in housing	80 x 22.5 x 99.5 [D] 80 x 36 x 94 [P]	81 x 17.5 x 67.2 [Mini-D]	81 x 17.5 x 67.2 [Mini-D]	80 x 22.5 x 99.5 [D] 80 x 36 x 94 [P]
Function	Over current and voltage monitoring relay. 1-phase AC/DC. Setpoint adjustable. Hysteresis adjustable.	Under voltage monitoring relay for DC battery. Setpoint adjustable. Hysteresis adjustable. Measures its own power supply.	Over and under voltage monitoring relay. 1-phase (measures its own power supply) AC TRMS.	Over or under voltage monitoring relay. 1-phase AC/DC TRMS. Setpoint adjustable. Hysteresis adjustable. Delay time adjustable.
Input specifications				
Measuring range	2 - 500 VAC/DC 0.4 - 4 V _P	8 - 28 VDC [724] 38 - 58 VDC [748]	208 / 220 / 230 / 240 VAC	0.1 - 10 VAC/DC [10 V] 2-500 VAC/DC [500 V]
Output specifications				
	1 x SPDT relay	1 x SPDT relay	1 x SPDT relay	1 x SPDT relay
Max. load AC1	8 A / 250 VAC	5 A / 250 VAC	5 A / 250 VAC	8 A / 250 VAC
Max. load DC12	5 A / 24 VDC	5 A / 24 VDC	5 A / 24 VDC	5 A / 24 VDC
Electrical life	>1 x 10 ⁵ operations	>1 x 10 ⁵ operations	>1 x 10 ⁵ operations	>1 x 10 ⁵ operations
General specifications				
Power supply	24 - 48 VAC/DC [D48] 115 / 230 VAC [B23]	8 - 28 VDC [724] 38 - 58 VDC [748]	208 - 480 VAC	24-48 VAC/DC [D48] 115 / 230 VAC [B23]
Approvals/Marks	CE - UL - CSA	CE - UL - CSA	CE - UL - CSA	CE - UL - CSA
References				
	DUA01C D48 500V	DUA52 C724	DUA55 CM44	DUB01C D48 10V
	PUA01C D48 500V	DUA52 C748		DUB01C D48 500V
	DUA01C B23 500V			PUB01C D48 10V
	PUA01C B23 500V			PUB01C D48 500V
				DUB01C B23 10V
				DUB01C B23 500V
				PUB01C B23 10V
				PUB01C B23 500V





Monitoring relays

Voltage relays

Types	DUB 71	DUB 02 PUB 02	DUB 03 PUB 03	DUC 01 PUC 01
				
Dimensions HxWxD (mm)	81 x 35.5 x 67.2 [Mini-D]	80 x 22.5 x 99.5 [D] 80 x 36 x 94 [P]	80 x 22.5 x 99.5 [D] 80 x 36 x 94 [P]	80 x 45 x 99.5 [D] 80 x 36 x 94 [P]
DIN RAIL housing				
Plug-in housing				
Function	Over or under voltage monitoring relay. 1-phase AC/DC TRMS. Setpoint adjustable. Hysteresis adjustable. Delay time adjustable.	Over and under voltage monitoring relay. 1-phase (measures its own power supply) AC TRMS. Over and under voltage setpoints separately adjustable. Hysteresis adjustable. Delay time adjustable (ON/OFF).	Over or under voltage monitoring relay. 1-phase (measures its own power supply) AC/DC TRMS. Setpoint adjustable. Hysteresis adjustable. Delay time adjustable.	Over and under voltage monitoring relay. 1-phase AC/DC TRMS. 2 setpoints separately adjustable. Hysteresis adjustable. 2 delay functions separately adjustable.
Input specifications				
Measuring range	0.1 - 10 VAC/DC [10 V] 2-500 VAC/DC [500 V]	24/115/230 VAC	24/48/115/240 VAC/DC	2 - 500 VAC/DC [500 V]
Output specifications				
	1 x SPDT relay	1 x SPDT relay	1 x SPDT relay [P]	1 x SPDT relay [C] 2 x DPDT relay [D]
Max. load AC1	5 A / 250 VAC	8 A / 250 VAC	8 A / 250 VAC	8 A / 250 VAC
Max. load DC12	5 A / 24 VDC	5 A / 24 VDC	5 A / 24 VDC	5 A / 24 VDC
Electrical life	>1 x 10 ⁵ operations	>1 x 10 ⁵ operations	>1 x 10 ⁵ operations	>1 x 10 ⁵ operations
General specifications				
Power supply	24/48 VAC [B48] 115 / 230 VAC [B23]	24/115/230 VAC	12 - 240 VAC/DC	24 - 48 VAC/DC [D48] 115 / 230 VAC [B23]
Approvals/Marks	CE - UL - CSA	CE - UL - CSA	CE - UL - CSA	CE - UL - CSA
References				
	DUB71C B48 10V	DUB02C T23	DUB03C W24	DUC01D D48 500V
	DUB71C B48 500V	PUB02C T23	PUB03C W24	PUC01C D48 500V
	DUB71C B23 10V			DUC01D B23 500V
	DUB71C B23 500V			PUC01C B23 500V

Monitoring relays

3-phase voltage relays

Types	DPA 01 PPA 01	DPA 51 DPA 71	DPA 03 PPA 03	DPA 53
				
Dimensions HxWxD (mm) DIN RAIL housing	80 x 22.5 x 99.5 [D]	81 x 17.5 x 67.2 [Mini-D] 81 x 35.5 x 67.2 [Mini-D]	80 x 22.5 x 99.5 [D]	81 x 17.5 x 67.2 [Mini-D]
Plug-in housing	80 x 36 x 94 [P]		80 x 36 x 94 [P]	
Function	Phase sequence, total and partial phase loss monitoring relay. 3-phase AC (measures its own power supply). Regenerated voltage.	Phase sequence, total and partial phase loss monitoring relay. 3-phase AC (measures its own power supply). Regenerated voltage.	Under voltage, phase sequence, total and partial phase loss monitoring relay. 3-phase (measures its own power supply) AC TRMS.	Under voltage, phase sequence, total and partial phase loss monitoring relay. 3-phase (measures its own power supply) AC TRMS.

Input specifications

Measuring range	208 - 240 VAC [M23] 208 - 415 VAC [P] [M44] 208 - 480 VAC [D] [M44] 380 - 415 VAC [P] [M48] 380 - 480 VAC [D] [M48] 380 - 600 VAC [M60] 380 - 690 VAC [M69]	208 - 240 VAC [M23] 208 - 480 VAC [M44] 380 - 480 VAC [M48]	208 - 240 VAC [M23] 380 - 415 VAC [P] [M48] 380 - 480 VAC [D] [M48] 600 - 690 VAC [M69]	208 - 240 VAC [M23] 380 - 480 VAC [M48]
-----------------	---	---	--	--

Output specifications

	1 x SPDT relay [C] 1 x DPDT relay [D]	1 x SPDT relay [C] 1 x DPDT relay [D]	1 x SPDT relay	1 x SPDT relay
Max. load AC1	8 A / 250 VAC	5 A / 250 VAC	8 A / 250 VAC	5 A / 250 VAC
Max. load DC12	5 A / 24 VDC	5 A / 24 VDC	5 A / 24 VDC	5 A / 24 VDC
Electrical life	>1 x 10 ⁵ operations	>1 x 10 ⁵ operations	>1 x 10 ⁵ operations	>1 x 10 ⁵ operations

General specifications



Power supply	208 - 240 VAC [M23] 208 - 415 VAC [P] [M44] 208 - 480 VAC [D] [M44] 380 - 415 VAC [P] [M48] 380 - 480 VAC [D] [M48] 380 - 600 VAC [M60] 380 - 690 VAC [M69]	208 - 240 VAC [M23] 208 - 480 VAC [M44] 380 - 480 VAC [M48]	208 - 240 VAC [M23] 380 - 415 VAC [P] [M48] 380 - 480 VAC [D] [M48] 600 - 690 VAC [M69]	208 - 240 VAC [M23] 380 - 480 VAC [M48]
Approvals/Marks	CE - UL - CSA	CE - UL - CSA	CE - UL - CSA	CE - UL - CSA

References

DPA01D M23	DPA51C M44	DPA03C M23	DPA53C M23
PPA01D M23	DPA71D M23	PPA03C M23	DPA53C M48
DPA01C M44	DPA71D M48	DPA03C M48	
PPA01C M44		PPA03C M48	
DPA01D M48		DPA03C M69	
PPA01D M48			
DPA01C M60			
DPA01C M69			

Monitoring relays

3-phase voltage relays

Types	DPA 55	DPB 01 PPB 01	DPB 51
			
Dimensions HxWxD (mm) DIN RAIL housing Plug-in housing	81 x 17.5 x 67.2 [Mini-D]	80 x 22.5 x 99.5 [D] 80 x 36 x 94 [P]	90 x 17.5 x 67.2 [Mini-D]
Function	Over and under voltage, phase sequence, total and partial phase loss monitoring relay. 3-phase (measures its own power supply) AC TRMS. Two tolerance voltage windows.	Over and under voltage monitoring relay with phase loss and phase sequence. 3-phase +N (measures its own power supply) AC TRMS. N versions without phase sequence detection. W4 versions supplied between L and N. 2 setpoints separately adjustable. Delay time adjustable.	Over and under voltage monitoring relay with phase loss, neutral loss and phase sequence. 3-phase +N (measures its own power supply) AC TRMS. 2 setpoints separately adjustable. Delay time adjustable.
Input specifications			
Measuring range	208 - 480 VAC	208 - 240 VAC [M23] 380 - 415 VAC [P] [M48] 380 - 480 VAC [D] [M48]	208 - 480 VAC
Output specifications			
	1 x SPDT relay	1 x SPDT relay	1 x SPDT relay
Max. load AC1	5 A / 250 VAC	8 A / 250 VAC	5 A / 250 VAC
Max. load DC12	5 A / 24 VDC	5 A / 24 VDC	5 A / 24 VDC
Electrical life	>1 x 10 ⁵ operations	>1 x 10 ⁵ operations	>1 x 10 ⁵ operations
General specifications			
Power supply	208 - 480 VAC	208 - 240 VAC [M23] 380 - 415 VAC [P] [M48] 380 - 480 VAC [D] [M48] [W]	208 - 480 VAC
Approvals/Marks	CE - UL - CSA	CE - UL - CSA	CE - UL - CSA
References			
	DPA55C M44	DPB01C M23	DPB51C M44
		PPB01C M23	DPB51C M44T
		DPB01C M23 N	DPB51C M44B006
		PPB01C M23 N	DPB51C M44B006T
		DPB01C M48	
		PPB01C M48	
		DPB01C M48 W4	
		PPB01C M48 W4	
		DPB01C M48 N	
		PPB01C M48 N	
		DPB01C M48 N W4	
		PPB01C M48 N W4	

Monitoring relays

3-phase voltage relays

Types	DPB 71	DPB 02 PPB 02	DPC 01 PPC 01
-------	--------	------------------	------------------



Dimensions HxWxD (mm) DIN RAIL housing Plug-in housing	81 x 35.5 x 67.2 [Mini-D]	80 x 22.5 x 99.5 [D] 80 x 36 x 94 [P]	80 x 45 x 99.5 [D] 80 x 36 x 94 [P]
Function	Over and under voltage monitoring relay with phase loss and phase sequence. 3-phase +N (measures its own power supply) AC TRMS. 2 setpoints separately adjustable. Delay time adjustable.	Asymmetry monitoring relay with phase sequence / phase loss. 3-phase +N (measures its own power supply) AC TRMS. Adjustable asymmetry. Delay time adjustable.	Over and under voltage monitoring relay with phase loss / phase sequence, asymmetry and tolerance. 3-phase +N (measures its own power supply) AC TRMS. Setpoint separately adjustable by function.

Input specifications

Measuring range	208 - 240 VAC [M23] 380 - 480 VAC [M48]	208 - 240 VAC [M23] 380 - 415 VAC [P] [M48] 380 - 480 VAC [D] [M48]	208 - 240 VAC [M23] 380 - 415 VAC [P] [M48] 380 - 480 VAC [D] [M48] 600 - 690 VAC [M69] Frequency 50 - 60 Hz 100 - 115 VAC [M11 400Hz] 208 - 240 VAC [M23 400Hz] 380 - 415 VAC [M48 400Hz] 440 - 480 VAC [M49 400Hz] 600 - 690 VAC [M69 400Hz] Frequency 50 - 400 Hz
-----------------	--	---	--

Output specifications

	1 x SPDT relay	1 x SPDT relay	2 x SPDT relay
Max. load AC1	5 A / 250 VAC	8 A / 250 VAC	8 A / 250 VAC
Max. load DC12	5 A / 24 VDC	5 A / 24 VDC	5 A / 24 VDC
Electrical life	>1 x 10 ⁵ operations	>1 x 10 ⁵ operations	>1 x 10 ⁵ operations

General specifications



Power supply	208 - 240 VAC [M23] 380 - 480 VAC [M48]	208 - 240 VAC [M23] 380 - 415 VAC [P] [M48] 380 - 480 VAC [D] [M48]	100 - 115 VAC [M11] 208 - 240 VAC [M23] 380 - 415 VAC [P] [M48] 380 - 480 VAC [D] [M48] 440 - 480 VAC [M49] 600 - 690 VAC [M69]
Approvals/Marks	CE - UL - CSA	CE - UL - CSA	CE - UL - CSA

References

	DPB71C M23	DPB02C M23	DPC01D M23
	DPB71C M48	PPB02C M23	PPC01D M23
		DPB02C M48	DPC01D M48
		PPB02C M48	PPC01D M48
			DPC01D M69
			DPC01D M11 400HZ
			DPC01D M23 400HZ
			DPC01D M48 400HZ
			DPC01D M49 400HZ
			DPC01D M69 400HZ

Monitoring relays

3-phase multifunction voltage relays

Types	DPC 71 PPC 71	DPC 02	DPD
			
Dimensions (mm) HxWxD			
DIN RAIL housing	81 x 35.5 x 67.2 [D]	80 x 45 x 99.5 [D]	80 x 45 x 99.5 [D]
Plug-in housing	81.2 x 35.5 x 75 [P]		
Function	Over and under voltage monitoring relay with phase loss / phase sequence, asymmetry and tolerance. 3-phase +N (measures its own power supply) AC TRMS. Setpoints separately adjustable by function.	Over and under voltage / over and under frequency with phase loss and phase sequence monitoring relay. 3-phase+N (measures its own power supply) AC TRMS. Setpoints separately adjustable. Separately adjustable delay times. Adjustable frequency range.	Over and under voltage / over and under frequency with phase loss and phase sequence monitoring relay. NFC Communication 3-phase / 3-phase+N. Setpoints separately adjustable. Separately adjustable delay times. Adjustable frequency range.

Input specifications

Measuring range	208 - 240 VAC [M23] 380 - 415 VAC [P] [M48] 380 - 480 VAC [D] [M48]	Voltage: 208 - 240 VAC [M23] 380 - 415 VAC [M48] 440 - 480 VAC [M49] 600 - 690 VAC [M69] Frequency: 50 / 60 Hz	Voltage: 102 V _{LN} to 318 V _{LN} 176 V _{LL} to 552 V _{LL} Frequency: 45 Hz to 440 Hz
-----------------	---	--	---

Output specifications

Max. load AC1	2 x SPDT relays 5 A / 250 VAC	2 x SPDT relays 8 A / 250 VAC	2 x SPDT relays 8 A / 250 VAC
Max. load DC12	5 A / 24 VDC	5 A / 24 VDC	5 A / 24 VDC
Electrical life	>1 x 10 ⁵ operations	>1 x 10 ⁵ operations	>1 x 10 ⁵ operations

General specifications

Power supply	208 - 240 VAC [M23] 380 - 415 VAC [P] [M48] 380 - 480 VAC [D] [M48]	208 - 240 VAC [M23] 308 - 415 VAC [M48] 440 - 480 VAC [M49] 600 - 690 VAC [M69]	120 V _{LN} to 277 V _{LN} 208 V _{LL} to 480 V _{LL} Frequency: 50 Hz to 400 Hz
Approvals/Marks	CE - UL - CSA	CE - UL - CSA ENEL DK 5950 [B003]	CE - cULus - CCC

References

DPC71D M23	DPC02D M23	DPD02D M44
PPC71D M23	DPC02D M48	DPD02D M44B
DPC71D M48	DPC02D M49	
PPC71D M48	DPC02D M69	
	DPC02D M23 B003	
	DPC02D M48 B003	

Monitoring relays

Interface protection relays

Types

DPC 72

PI-DIN



Dimensions HxWxD (mm)

90 x 71.6 x 66.3 [D]

90 x 71.6 x 66.3

Description

Digital interface protection relay with over and under voltage / over and under frequency, phase loss and phase sequence controls. Frequency derivative monitoring [B001, B003], voltage quality [B002], RS485 port, event counter, datatimestamping and auto-test function. 3-phase (measures its own power supply) AC TRMS. Setpoints separately adjustable. Separately adjustable delay times. Programmable via PC (DpcSoft free configuration software).

1- or 3-phase systems monitoring relay interface protection.

Measuring input

Voltage range

380-415 VAC [M48]

230 V_{LN}, 400 V_{LL}

Frequency range

45-65 Hz

47.5 to 51.5 Hz

Display

LCD, 2 lines 4 DGT, 1 line 8 DGT

LCD, 2 lines 4 DGT, 1 line 8 DGT

Input specifications

VDE-AR-N-4105

2 digitals

CEI 0-21

4 digitals

Output specifications

Type

1 x DPDT relays

2 x SPDT relays

Max. load AC1

8 A / 250 VAC

8 A @ 250 VAC

Max. load DC12

5 A / 24 VDC

5 A / 24 VDC

Electrical life

>1 x 10⁵ operations

>1 x 10⁵ operations

Serial communication protocol

RS485

RS485

Protocol

Modbus RTU

Modbus RTU

General specifications

Power supply

308 - 415 VAC [M48]

115..230 VCA -20% +15%
(48..62 Hz)
Option 24 VDC -20% +10%

Approvals/Marks

CE - VDE 0126-1-1 [B002]

CE - VDE V 0126-1-1:2013 - VDE AR N 4105 - CEI 0 - 21

References

DPC72D M48 B01

DPC72D M48 B02

CEI 0-21 (AC aux power)

PIDIN0021HI4R2S1XX

CEI 0-21 (DC aux power)

PIDIN0021LI4R2S1XX

VDE V 0126-1-1:2013 (AC aux power)

VDE AR N 4105 (AC aux power)



PIDIN0126HI2R2S1XX

VDE V 0126-1-1:2013 (DC aux power)

VDE AR N 4105 (DC aux power)



PIDIN0126LI2R2S1XX

Monitoring relays

	Frequency relays		Cosφ relays
Types	DFB 01 PFB 01	DFC 01	DWA 01 PWA 01
			
Dimensions HxWxD (mm)		80 x 45 x 99.5 [D]	
DIN RAIL housing	80 x 22.5 x 99.5 [D]		80 x 22.5 x 99.5 [D]
Plug-in housing	80 x 36 x 94 [P]		80 x 36 x 94 [P]
Function	Frequency monitoring relay. 1-phase AC (measures its own power supply). 2 setpoints separately adjustable. Delay time adjustable.	Frequency monitoring relay. 1-phase AC (measures its own power supply). 2 setpoints separately adjustable. 2 separately adjustable delay times. 2 separate relay outputs.	Cosφ monitoring relay. 1- or 3-phase AC (measures its own power supply). Direct input or through external CT. Power ON delay adjustable.
Input specifications			
Measuring range	50 / 60 Hz	50 / 60 Hz	cosφ : 0.1-0.99
Output specifications			
	1 x SPDT relay	2 x SPDT relay	1 x SPDT relay
Max. load AC1	8 A / 250 VAC	8 A / 250 VAC	8 A / 250 VAC
Max. load DC12	5 A / 24 VDC	5 A / 24 VDC	5 A / 24 VDC
Electrical life	>1 x 10 ⁵ operations	>1 x 10 ⁵ operations	>1 x 10 ⁵ operations
General specifications			
Power supply	24 - 240 VAC	24 - 48 VAC [B48] 115 - 230 VAC [B23]	208 - 240 VAC [M23] 380 - 415 VAC [P] [M48] 380 - 480 VAC [D] [M48]
Approvals/Marks	CE - UL - CSA	CE - UL - CSA	CE - UL - CSA
References			
	DFB01C M24	DFC01D B48	DWA01C M23 5A
	PFB01C M24	DFC01D B23	PWA01C M23 5A
			DWA01C M48 5A
			PWA01C M48 5A

Monitoring relays

Power and power factor relays

Types	DWB 01 PWB 01	DWB 02 PWB 02	DWB 03 PWB 03
			
Dimensions HxWxD (mm)	80 x 45 x 99.5 [D] 80 x 36 x 94 [P]	80 x 45 x 99.5 [D] 80 x 36 x 94 [P]	80 x 45 x 99.5 [D] 80 x 36 x 94 [P]
DIN RAIL housing			
Plug-in housing			
Function	Power factor monitoring relay. 1- or 3-phase (measures its own power supply) AC TRMS. Direct input or through external CT. 2 separately adjustable setpoints. Delay time adjustable. Power ON delay adjustable.	Active power monitoring relay. 1- or 3-phase (measures its own power supply) AC TRMS. Direct input or through external CT. 2 separately adjustable setpoints. Delay time adjustable. Power ON delay adjustable.	Active power monitoring relay. 1- or 3-phase AC TRMS power direction (measures its own power supply). Direct input or through external CT. 2 separately adjustable setpoints. Delay time adjustable. Power ON delay adjustable.

Input specifications

Measuring range	cosφ : 0.1 - 0.99	208 - 690 VAC 0.5 - 5 AAC 1 - 10 AAC 0.4 - 4 Vp	208 - 690 VAC 0.5 - 5 AAC 1 - 10 AAC 0.4 - 4 Vp
-----------------	-------------------	--	--

Output specifications

	1 x SPDT relays	1 x SPDT relays	1 x SPDT relays
Max. load AC1	8 A / 250 VAC	8 A / 250 VAC	8 A / 250 VAC
Max. load DC12	5 A / 24 VDC	5 A / 24 VDC	5 A / 24 VDC
Electrical life	>1 x 10 ⁵ operations	>1 x 10 ⁵ operations	>1 x 10 ⁵ operations



General specifications

Power supply	208 - 240 VAC [M23] 380 - 415 VAC [P] [M48] 380 - 480 VAC [D] [M48] 600 - 690 VAC [M69]	208 - 240 VAC [M23] 380 - 415 VAC [P] [M48] 380 - 480 VAC [D] [M48] 600 - 690 VAC [M69]	208 - 240 VAC [M23] 380 - 415 VAC [P] [M48] 380 - 480 VAC [D] [M48] 600 - 690 VAC [M69]
Approvals/Marks	CE - UL - CSA	CE - UL - CSA	CE - UL - CSA

References

	DWB01C M23 10A	DWB02C M23 10A	DWB03C M23 10A
	PWB01C M23 10A	PWB02C M23 10A	PWB03C M23 10A
	DWB01C M48 10A	DWB02C M48 10A	DWB03C M48 10A
	PWB01C M48 10A	PWB02C M48 10A	PWB03C M48 10A
	DWB01C M69 10A	DWB02C M69 10A	DWB03C M69 10A

Monitoring relays

	Temperature relays	Motor thermistor relays	Pump alternating relays
Types	DTA 01 PTA 01 DTA 02 PTA 02	DTA 71 DTA 72	DLA 71 DLA 73
			
Dimensions HxWxD (mm)			
DIN RAIL housing	80 x 22.5 x 99.5 [D]	81 x 35.5 x 67.2 (Mini-D)	81 x 35.5 x 67.2 (Mini-D)
Plug-in housing	80 x 36 x 94 [P]		
Function	Motor temperature monitoring relays. PTC insulated input. Automatic set-point. Short circuit detection. Latch, test and reset function (DTA02, PTA02).	Motor Thermistor relays. PTC insulated input. Automatic set-point. Short circuit and Open Circuit detection. Automatic Reset (DTA71) Latch, test, reset, ready for reset functions. (DTA02).	Pump alternating relay. For 2 or 3 pumps. Differential or sequential mode. Automatic rotation of the pumps. Output relay managed by one independent input contact (DLA73).

Output specifications

	1 x SPDT relay 1 x SPST relay [DTA01]	1 x SPDT relay [DTA01] 2 x SPDT relay [DTA01]	2 x SPST relay [DLA71] [2P] 3 x SPST relay [DLA71] [3P] 3 x SPST relay [DLA73]
Max. load AC1	8 A / 250 VAC	8 A / 250 VAC	5 A / 250 VAC
Max. load DC12	5 A / 24 VDC	5 A / 24 VDC	5 A / 24 VDC
Electrical life	>1 x 10 ⁵ operations	>1 x 10 ⁵ operations	>1 x 10 ⁵ operations

General specifications

Power supply	24 - 48 VAC/DC [D48] 115 VAC [115] 230 VAC [230]	24 - 240 VAC/DC	24 / 48 VAC [B48] 115 / 230 VAC [B23]
Approvals/Marks	CE - UL - CSA	CE - UL	CE - UL - CSA

References

DTA01C D48	DTA71CM24	DLA71D B48 2P
PTA01C D48	DTA72DM24	DLA71T B48 3P
DTA01C 115		DLA71D B23 2P
PTA01C 115		DLA71T B23 3P
DTA01C 230		DLA73T B23 2P
PTA01C 230		DLA73T B48 2P
DTA02C D48		
PTA02C D48		
DTA02C 115		
PTA02C 115		
DTA02C 230		
PTA02C 230		

Timers

Delay on operate

Types	DAA 01 PAA 01	DAA 51 DAA 71	FAA 01 FAA 08
-------	------------------	------------------	------------------



Dimensions HxWxD (mm)			
DIN RAIL housing	80 x 22.5 x 99.5 [D] 80 x 36 x 94 [P]	81 x 17.5 x 67.2 [Mini-D] 81 x 35.5 x 67.2 [Mini-D]	
Plug-in housing			48 x 48 x 83.4

Function	Delay on operate (manual start).	Delay on operate (automatic start).	Delay on operate. Symmetrical recycler. Interval. One shot.
----------	----------------------------------	-------------------------------------	--

Input specifications

Time range	0.1 s - 1 s 1 s - 10 s 6 s - 60 s 60 s - 600 s 0.1 h - 1 h 1 h - 10 h 10 h - 100 h	0.1 s - 1 s 1 s - 10 s 6 s - 60 s 60 s - 600 s 0.1 h - 1 h 1 h - 10 h 10 h - 100 h	Full scale 12 0.02 - 1.2 s 0.2 - 12 s 2 - 120 s 0.2 - 12 m 2 - 120 m 0.2 - 12 h 2 - 120 h	Full scale 30 0.05 - 3 s 0.5 - 30 s 5 - 300 s 0.5 - 30 m 5 - 300 m 0.5 - 30 h 5 - 300 h
------------	--	--	--	--

Output specifications

	1 x SPDT relay [C] 2 x SPDT relays [D]	1 x SPDT relay [C] 1 x DPDT relay [D]	1 x DPDT relay 11-pin [01] 8-pin [08]
Max. load AC1	8 A / 250 VAC	5 A / 250 VAC	5 A / 250 VAC
Max. load DC12	5 A / 24 VDC	5 A / 24 VDC	5 A / 24 VDC
Electrical life	>1 x 10 ⁵ operations	>1 x 10 ⁵ operations	>1 x 10 ⁵ operations

General specifications

Power supply	24 VDC / 24 - 240 VAC [C] 24 - 240 VAC/DC [D]	24 VDC / 24-240 VAC [CM24] 24-240 VAC / DC [DM24] 12-240 VAC / DC [DW24]	12-240 VAC / DC
Approvals/Marks	CE - UL - CSA	CE - UL - CSA - RINA [DAA51 only] - CCC [DAA51_B001 only]	CE - UL - CSA

References

DAA01C M24	DAA51C M24	FAA01D W24
PAA01C M24	DAA71D M24	FAA08D W24
DAA01D M24	DAA71D W24	
PAA01D M24		

Timers

Delay on operate

Delay on release

Types	HAA 08 HAA 14	DBA 02 PBA 02	DBA 52
			

Dimensions HxWxD (mm)			
DIN RAIL housing		80 x 22.5 x 99.5 [D] 80 x 36 x 94 [P]	81 x 17.5 x 67.2 [Mini-D]
Plug-in housing	28 x 21.5 x 64		
Function	Delay on operate. Symmetrical recycler with ON or OFF first. Interval.	Delay on release.	Delay on release.

Input specifications

Time range	0.1 s - 1 s 1 s - 10 s 6 s - 60 s 60 s - 600 s 0.1 h - 1 h 1 h - 10 h 10 h - 100 h	0.1 s - 1 s / 1 s - 10 s 6 s - 60 s / 60 s - 600 s 0.1 h - 1 h / 1 h - 10 h 10 h - 100 h	0.1 s - 1 s / 1 s - 10 s 6 s - 60 s / 60 s - 600 s 0.1 h - 1 h / 1 h - 10 h 10 h - 100 h
------------	--	---	---

Output specifications

	1 x 4PDT relay [Q] 1 x DPDT relay [D] 14-pin [14] 8-pin [08]	1 x SPDT relay	1 x SPDT relay
Max. load AC1	5 A / 250 VAC	8 A / 250 VAC	5 A / 250 VAC
Max. load DC12	5 A / 24 VDC	5 A / 24 VDC	5 A / 24 VDC
Electrical life	>1 x 10 ⁵ operations	>1 x 10 ⁵ operations	>1 x 10 ⁵ operations



General specifications

Power supply	24-240 VAC / DC	24 VDC / 24-240 VAC	24 VDC / 24-240 VAC
Approvals/Marks	CE - UL - CSA	CE - UL - CSA	CE - UL - CSA

References





	HAA14Q M24 HAA08D M24	DBA02C M24 PBA02C M24	DBA52C M24
--	--------------------------	--------------------------	------------

Timers

	True delay on release		Recycler	
Types	D/PBB 01 D/PBB 02	DBB 51	DCB 01 PCB 01	DCB 51
				
Dimensions HxWxD (mm) DIN RAIL housing Plug-in housing	80 x 22.5 x 99.5 [D] 80 x 36 x 94 [P]	81 x 17.5 x 67.2 [Mini-D]	80 x 22.5 x 99.5 [D] 80 x 36 x 94 [P]	81 x 17.5 x 67.2 [Mini-D]
Function	True delay on release.	True delay on release.	Asymmetrical recycler with ON and OFF time first. One shot. Two state delay on operate.	Asymmetrical recycler with ON or OFF first.
Input specifications				
Time range	D/PBB01: 0.1 s - 1 s / 1 s - 10 s 6 s - 60 s / 60 s - 600 s D/PBB02: 60 s - 600 s / 0.1 h - 1 h 1 h - 10 h	1 s - 10 s [10S] 6 s - 60 s [1M] 60 s - 600 s [10M]	0.1 - 1 s / 1 - 10 s 6 - 60 s / 60 s - 600 s 0.1 h 1 h / 1 h - 10 h 10 h - 100 h	0.1 - 1 s / 1 - 10 s 6 - 60 s / 60 s - 600 s 0.1 h 1 h / 1 h - 10 h 10 h - 100 h
Output specifications				
	1 x SPDT relay [C] 1 x DPDT relay [D]	1 x SPDT relay	1 x SPDT relay [C] 2 x SPDT relays [D]	1 x SPDT relay
Max. load AC1	8 A / 250 VAC	5 A / 250 VAC	8 A / 250 VAC	5 A / 250 VAC
Max. load DC12	5 A / 24 VDC	5 A / 24 VDC	5 A / 24 VDC	5 A / 24 VDC
Electrical life	>1 x 10 ⁵ operations	>1 x 10 ⁵ operations	>1 x 10 ⁵ operations	>1 x 10 ⁵ operations
General specifications				
Power supply	24-240 VAC / DC [M24] 12-24 VDC [724]	24 VDC / 24-240 VAC	24 VDC / 24-240 VAC [C] 24-240 VAC / DC [D]	24 VDC / 24-240 VAC
Approvals/Marks	CE - UL - CSA	CE - UL - CSA	CE - UL - CSA	CE - UL - CSA
References				
	DBB01C M24	DBB51C M24 10S	DCB01C M24	DCB51C M24
	PBB01C M24	DBB51C M24 1M	PCB01C M24	
	DBB01D M24	DBB51C M24 10M	DCB01D M24	
	PBB01D M24		PCB01D M24	
	DBB01C 724			
	PBB01C 724			
	DBB01D 724			
	PBB01D 724			
	DBB02C M24			
	PBB02C M24			
	DBB02D M24			
	PBB02D M24			

Timers

Multifunction

Types	DMB 01 PMB 01	DMB 51 DMB 71	FMB 01	DMC 01 PMC 01
				
Dimensions HxWxD (mm)	80 x 22.5 x 99.5 [D]	81 x 17.5 x 67.2 [Mini-D] 81 x 35.5 x 67.2 [Mini-D]	48 x 48 x 83.4	80 x 22.5 x 99.5 [D] 80 x 45 x 99.5 [D] 80 x 36 x 94 [P]
Plug-in housing	80 x 36 x 94 [P]			
Function	Multifunction: <ul style="list-style-type: none"> • Delay on operate - manual start • Delay on release • Interval - manual start • Symmetrical recycler • Double interval • Interval on trigger open 	Multifunction: <ul style="list-style-type: none"> • Delay on operate - manual start • Delay on release • Interval - manual start • Symmetrical recycler • Double interval • Interval on trigger open 	Multifunction: (Trigger, Gate and Reset inputs) <ul style="list-style-type: none"> • Delay on operate - manual start • Delay on release • Interval - manual start • Symmetrical recycler • Double interval • Interval on trigger open 	Multifunction: <ul style="list-style-type: none"> • Delay on operate - manual start • Delay on operate - automatic and manual start • Delay on release • Interval - manual start • Interval - automatic and manual start • Interval - manual start with no time reset • Interval - automatic and manual start with no time reset

Input specifications

Time range	0.1 s - 1 s / 1 s - 10 s 6 s - 60 s / 60 s - 600 s 0.1 h - 1 h / 1 h - 10 h 10 h - 100 h	0.1 s - 1 s / 1 s - 10 s 6 s - 60 s / 60 s - 600 s 0.1 h - 1 h / 1 h - 10 h 10 h - 100 h	Full scale: 12 0.02 - 1.2 s / 0.2 - 12 s 2 - 120 s / 0.2 - 12 m 2 - 120 m / 0.2 - 12 h 2 - 120 h Full scale: 30 0.05 - 3 s / 0.5 - 30 s 5 - 300 s / 0.5 - 30 m 5 - 300 m / 0.5 - 30 h 5 - 300 h	0.1 s - 1 s / 1 s - 10 s 6 s - 60 s / 60 s - 600 s 0.1 h - 1 h / 1 h - 10 h 10 h - 100 h
------------	---	---	--	---

Output specifications

	1 x SPDT relay [C] 1 x DPDT relay [D]	1 x SPDT relay [C] 1 x DPDT relay [D]	1 x DPDT relay	1 x SPDT relay [C] 2 x SPDT relay [D]
Max. load AC1	8 A / 250 VAC	5 A / 250 VAC	5 A / 250 VAC	8 A / 250 VAC
Max. load DC12	5 A / 24 VDC	5 A / 24 VDC	5 A / 24 VDC	5 A / 24 VDC
Electrical life	>1 x 10 ⁵ operations	>1 x 10 ⁵ operations	>1 x 10 ⁵ operations	>1 x 10 ⁵ operations

General specifications



Power supply	24 VDC & 24-240 VAC [C] 24-240 VAC/DC [D]	24 VDC & 24-240 VAC [M24] 12-240 VAC/DC [W24]	12-240 VAC/DC	24 VDC [724] 24 / 48 VAC [B48] 115 / 230 VAC [B23] 24 VAC [024] 115 VAC [115] 230 VAC [230]
Approvals/Marks	CE - UL - CSA - RINA [DMB01 only]	CE - UL - CSA - RINA [DMB51 only] - CCC [DMB51_B006 only]	CE - UL - CSA	CE - UL - CSA

References

	DMB01C M24	DMB51C M24	FMB01D W24	DMC01C xxx
	PMB01C M24	DMB51C W24		PMC01C yyy
	DMB01D M24	DMB71D M24		DMC01D xxx
	PMB01D M24	DMB71D W24		PMC01D yyy





xxx= 724, B23, B48
yyy= 724, 024, 115, 230

Timers

	Mini-E timers	Star delta	
Types	EAS EBS ECS	DAC 01 PAC 01	DAC 51
			
Dimensions HxWxD (mm)	56 x 22.5 x 49 [Mini-E]	80 x 22.5 x 99.5 [D]	81 x 17.5 x 67.2 [Mini-D]
DIN RAIL housing	56 x 22.5 x 44 [Mini-E] [F]		
Plug-in housing		80 x 36 x 94 [P]	
Function	EAS - Delay on operate (automatic start). EBS - Interval (automatic start). ECS - Symmetrical recycler (ON/OFF automatic start) thyristor output. Screw or fast-ON connection. DIN-rail or chassis mounting	Star delta	Star delta
Input specifications			
Time range	[10S]: 0.5 s - 10 s [1M]: 0.1 m - 1 m [10M]: 1 m - 10 m	0.1 s - 1 s / 1 s - 10 s 6 s - 60 s / 60 s - 600 s	0.1 s - 1 s / 1 s - 10 s 6 s - 60 s / 60 s - 600 s
Star to delta relay (neutral centre position)		50 - 130 ms between star to delta position	50 - 130 ms between star to delta position
Output specifications			
	Static output 500 mA, 700 mA [F]	1 x SPDT relay (with neutral centre position)	1 x SPDT relay (with neutral centre position)
Max. load AC1		8 A / 250 VAC	5 A / 250 VAC
Max. load DC12		5 A / 24 VDC	5 A / 24 VDC
Electrical life		>1 x 10 ⁵ operations	>1 x 10 ⁵ operations
General specifications			
Power supply	24-230 VAC / DC [EAS] 24-230 VAC [EBS], [ECS]	24-240 VAC / DC [M24] 380-415 VAC [M40]	24-240 VAC / DC
Approvals/Marks	CE - UL - CSA	CE - UL - CSA	CE - UL - CSA
References			
	EAS S M23 ...	DAC01C M24	DAC51C M24
	EAS S M23 ... F	PAC01C M24	
	EBS S M23 ...	DAC01C M40	
	EBS S M23 ... F	PAC01C M40	
	ECS S M23 A ...		
	ECS S M23 B ...		
	ECS S M23 A ... F		
	ECS S M23 B ... F		
	... = insert code for Time Range		

Counters

Electromechanical counters

Types	EMCT46/EMCT47	E2CT4	E1CT4	ECH4
				
Version	Micro	Mini	Standard	Combination time and energy meter
Dimensions HxWxD (mm)	13.8 x 25 x 35.2 20 x 30 x 36.2	24 x 48 x 53.8	24 x 48 x 49	48 x 48 x 38
Technical data				
Number of digit	6/7	5	6	7/8
Reset	no	yes	no	no
Digit height, visible (mm)	4 x 1.7 / 4 x 1.2	4 x 1.7	4 x 1.7	4 x 1.7
Panel cut-out (mm)	e.g. 27 x 14	45 x 22 / 31 x 20	45 x 22 / 31 x 20	46 x 46 X Ø50.5
Mounting type	Panel / PCB	Panel / base mount / PCB	Panel / base mount / PCB	Panel / DIN-rail
Degree of protection	up to IP 65	IP 41	IP 41	IP 52 front side
Pulse voltage min. / max.	1.5 to 24 VDC	24 to 230 VAC 12 to 24 VDC	24 to 230 VAC 12 to 24 VDC	0 to 260 VAC 0 to 260 VDC
Max. count frequency	10 Hz	10 Hz	10 Hz	10 Hz
Min. power consumption	70 mW	0.75 VA (115 VAC) 1.5 VA (230 VAC) 130 mW VDC	0.75 VA (115 VAC) 1.5 VA (230 VAC) 50 mW VDC	1 W / 1.43 VA

References





EMCT46xxxxxx
EMCT47xxxxxx

E2CT4xxxxxx

E1CT4xxxxxx

ECH4

Electronic counters

Types	FKA	DCT86	DMF861	DMF862
				
Version	LCD-Panel mount	LED-Panel mount	LED-Panel mount	LED-Panel mount
Dimensions HxWxD (mm)	DIN 48 x 24	DIN 48 x 24	DIN 48 x 24	DIN 48 x 24
Function				
Totaliser	yes			
Pulse counter		yes	yes	2 pulse counters, Pulse counter and timer, Pulse and frequency meter or 2 timers
Position display for encoders			yes	
Frequency meter/Tachometer			yes	
Timer			yes	
Technical data				
Number of digit	8	6	6	6
Reset	manual / electric	manual / electric	manual / electric	manual / electric
Digit height, visible (mm)	8	8	8	8
Panel cut-out(mm)	45 x 22	45 x 22	45 x 22	45 x 22
Degree of protection	IP 65 front side	IP 65 front side	IP 65 front side	IP 65 front side
Power supply	Lithium battery	10 to 30 VDC	10 to 30 VDC	10 to 30 VDC
Count inputs	NPN/PNP 10 to 260 VAC/DC	NPN/PNP	NPN/PNP	NPN/PNP
References				
	FKAxxxxxx	DCT86xxxxxx	DMF861xxxxxx	DMF862xxxxxx

Counters

Digital multifunction

Types

DMF1461
DMF1462

Version	LED - Panel mount	LED - Panel mount
Dimensions HxWxD (mm)	DIN 96 x 48	DIN 96 x 48

Function

Pulse counter	Yes	2 pulse counters, Pulse counter and timer, Pulse and frequency meter or 2 timers
Position display for encoders	Yes	
Frequency meter / Tachometer	Yes	Yes
Timer	Yes	Yes

Technical data

Number of digit	6	6
Reset	manual / electric	manual / electric
Preset	-	-
Digit height, visible (mm)	14	14
Panel cut-out (mm)	92 x 45	92 x 45
Degree of protection	IP 65 front side	IP 65 front side
Max. count frequency (Hz)	60000	60000
Supply voltage	90...260 VAC / 10...30 VDC	90...260 VAC / 10...30 VDC
Count inputs	Schmitt-Trigger	Schmitt-Trigger

References

DMF1461xxx0
DMF1462xx0

Hour meter electromechanical

Types

E1HM4
E2HM4
E2HM35
E1HM35

Version	Panel mount	Panel mount	Panel mount	DIN rail
Dimensions HxWxD (mm)	DIN 48 x 24 - DIN 28 x 53	DIN 48 x 48	Ø71.1 - Ø58,7	90 x 36 x 66



Technical data

Number of digit	7/8	7/8	6	7
Time range	0.01~99999.99h	0.01~99999.99h	0.01~99999.9h	0.01~99999.99h
Digit height, visible (mm)	4	4	3.5	3.5
Panel cut-out (mm)	45 x 22 / 50 x 25	46 x 46	Ø50.08	-
Degree of protection	IP 65 front side	IP 65 front side	IP 65 front side	IP 65 front side
Min. power consumption (W/VA)	0.5 / 1.2	0.5 / 1.2	0.7 / 0.4	1 / 2.5
Voltage range	20...264 VAC 10...130 VDC	20...440 VAC 10...30 VDC	115...230 VAC 10...80 VDC	24 / 115 / 230 VAC 10...27 VDC

References





E1HM4xxxxxx
E2HM4xxxxxx
E2HM35xxxxxx
E1HM35xxxxxx

Counters

	Hour meter electronic LCD		Electronic multifunction counters
Types	FSA01	FSA02	DMF61 / DMF62
			
Version	LCD panel mount	LCD panel mount	LCD panel mount
Dimensions HxWxD (mm)	DIN 24 x 48	DIN 24 x 48	DIN 48 x 48
Technical data			
Number of digit	7	8	2 x 6
Time range	0.01 h; h.min	0.01 h; h.min	
Max. Count frequency (Hz)			50000
Preset			61 : 1 / 62 : 2
Reset	manual / electrical	manual / electrical	electronic
Digit height, visible (mm)	8	8	
Panel cut-out (mm)	45 x 22	45 x 22	45 x 45
Mounting type	Panel mount	Panel mount	Panel mount
Degree of protection	IP 65 front side	IP 65 front side	IP 65 front side
Power supply	Lithium battery (>8years)	Lithium battery (>8years)	90 to 260 VAC 10 to 30 VDC
Output			Relay or Optocoupler
Input			2 count inputs, gate, reset, lock, MPI, 4 optional inputs
References			
	FSA01xxxxx	FSA02xxxxx	DMF6101xxxx0 DMF6201xxxx0

Surge arresters

Surge arresters for AC lines

Types	DSF A/P	DSB A 52	DSB P 53	DSB P 54
				
Dimensions HxWxD (mm)	90 x 18 x 72 [51] 90 x 36 x 72 [52] 90 x 54 x 72 [53] 90 x 72 x 72 [54]	90 x 36 x 72	90 x 54 x 72	90 x 72 x 72
Description	No backup fuse Surge arresters for AC lines single or 3phase network types TN-S; TT; IT; TN-C Removable cartridges No leakage current	Surge arresters for AC lines single phase. Removable cartridges	Surge arresters for AC lines three phase Removable cartridges	Surge arresters for AC lines three phase Removable cartridges
Output specifications				
Out (Alarm)	1 x SPDT relay	1 x SPDT relay (option)	1 x SPDT relay (option)	1 x SPDT relay (option)
General specifications				
SPD class	Class II	Class II	Class II	Class II
Max. continuous voltage U _c	150 VAC 300 VAC 385 VAC 460 VAC 550 VAC 750 VAC	275 VAC / 350 VDC 385 VAC / 500 VDC	275 VAC / 350 VDC 385 VAC / 500 VDC 440 VAC / 580 VDC	275 VAC / 350 VDC 385 VAC / 500 VDC 440 VAC / 580 VDC
I _n (8/20)	20 kA 10 kA [DSF5xCA750]	20 kA / pole	20 kA / pole	20 kA / pole
I _{max} (8/20)	50 kA 25 kA [DSF5xCA750]	40 kA / pole	40 kA / pole	40 kA / pole
I _{imp} (10/350)	-	-	-	-
Response time	< 25 ns	< 25 ms with GDT 25 ms (L-N), 100 ms (N-PE) without GDT	< 25 ms	< 25 ms with GDT 25 ms (L-N), 100 ms (N-PE) without GDT
Back-up fuse	Not required up to 200 kArms	125 A gL	125 A gL	125 A gL
Mounitng	DIN rail	DIN rail	DIN rail	DIN rail
Temperature range	-40°C to +80°C -40°F to +176°F	-40°C to +80°C -40°F to +176°F	-40°C to +80°C -40°F to +176°F	-40°C to +80°C -40°F to +176°F
Approvals/Marks	CE, UR (UL 1449 3rd ED.), CSA	CE: IEC61643	CE: IEC61643	CE: IEC61643

References

For ordering key details, please refer to www.productselection.net

Surge arresters

	Surge arresters for PV systems		Surge arresters for communication lines	
Types	DSF D	DSC	DSB S	DSB DP
				
Dimensions HxWxD (mm)	90 x 36 x 72 [52] 90 x 54 x 72 [53]	90 x 72 x 72	90 x 12 x 71.5	90 x 12 x 71.5

Description	No backup fuse, 2-pole [52] or 3-pole [53] surge arresters for P.V. installations No leakage	Class I and II Surge arresters for DC systems	Surge arresters for RS485 communication lines Removable cartridges	Surge arresters for Dupline® and Smarthouse communication lines Removable cartridges
-------------	---	---	---	---

Output specifications

Out (Alarm)	1 x SPDT relay	1 x SPDT relay	None	None
-------------	----------------	----------------	------	------

General specifications



SPD class	Class II	Class I, II	Class C1/C2/C3 (IEC 60643-21)	Class C1/C2/C3 (IEC 60643-21)
Max. continuous voltage U_c	600 VDC [600, 1200] 1000 VDC [1000] 1200 VDC [1200]	1000 V	6 VDC	18 VDC
I_n (8/20)	20 kA [600, 1200] 12.5 kA [1000]	20 kA / pole	10 kA / pole	10 kA / pole
I_{max} (8/20)	40 kA [600, 1200] 25 kA [1000]	40 kA / pole	20 kA / pole	20 kA / pole
I_{imp} (10/350)	-	12.5 kA / pole	-	-
Response time	< 25 ns	<25 ns	<1 ns	<1 ns
Back-up fuse	Not required up to 200 kArms	N.A.		
Mounting	DIN rail	DIN rail	DIN rail	DIN rail
Temperature range	-40°C to +80°C -40°F to +176°F	-40°C to +80°C -40°F to +176°F	-40°C to +80°C -40°F to +176°F	-40°C to +80°C -40°F to +176°F
Approvals/Marks	CE, UR (UL 1449 3 rd ED.), UTE C 61-740-51, CSA	CE: IEC616431; UTE C61-740-51	CE: IEC 60643-21	CE: IEC 60643-21

References



DSF52XD600PV	DSC54CD1000PV	DSB51XXS	DSB51XXDP
DSF52CD600PV	DSC54XD1000PV		
DSF52XD1000PV			
DSF52CD1000PV			
DSF53XD1200PV			
DSF53CD1200PV			

Digital panel meters

Ammeters, voltmeters and frequency meters

Types	DI3 DIN	DI3 72	LDI 3
			
Dimensions HxWxD (mm)	89 x 52.5 x 58.5	72 x 72 x 75.5	48 x 96 x 83
Function	3-digit meter. 1-phase AC, DC. Voltmeter, ammeter frequency meter.	Microprocessor based indicator. AC / DC Ammeter, Voltmeter. Freq. meter 3-digit display red LED. Height: 14.2 mm.	Microprocessor based indicator. AC / DC Ammeter, Voltmeter. Freq. meter 3-digit display.
Input specifications			
Range code	1 A / 100 VAC [AV1] 5 A / 500 VAC [AV5] 1 A / 60 mV / 100 V / 500 VDC [AV6] 1 Hz to 1000 Hz [F1K]	[AV1]: 1 AAC / 100 VAC [AV5]: 5 AAC / 500 VAC [AV6]: 1 ADC / 60 mV / 100 V / 500 VDC	[AV1]: 1 AAC / 100 VAC [AV5]: 5 AAC / 500 VAC [AV6]: 1 ADC / 60 mV / 100 V / 500 VDC [F1K]: 1 to 1000 Hz
Accuracy	0.5% FS (0.1% FS frequency meter)	±0.5% FS	±0.5% FS (±0.3% FS frequency meter)
Indication	Max.	999 [AV1 / AV5], 000 [AV1 / AV5]	999
	Min.	000 [AV1 / AV5] -99 [AV6]	000 [AV1 / AV5] -99 [AV6]
Range selection / decimal point pos.	Selectable by DIP-switch	Selectable by DIP-switch	Selectable by DIP-switch
Display refresh time	1 time/s	1 time/s	1 time/s
General specifications			
Power supply	24 VAC [A] 48 VAC [B] 115 VAC [C] 230 VAC [D]	24 VAC [A], 48 VAC [B], 115 VAC [C], 230 VAC [D]	24 VAC [A], 48 VAC [B], 115 VAC [C], 230 VAC [D]
Option		IP65[EX]	IP65[IX], tropicalization [XT]
Safety Standards	EN 61010-1, IEC 61010-1, VDE0411	EN 61010-1, IEC 61010-1, VDE0411	EN 61010-1, IEC 61010-1, VDE0411
Approvals/Marks	CE - CSA	CE - CSA	CE - c CSA us
References			
For ordering key details, please refer to www.productselection.net			

Digital panel meters

	Ammeters and voltmeters		Thermometer and ohmmeter
Types	LDI 35 AV0	LDI 35 AV2	LDI 35 CF
			
Dimensions HxWxD (mm)	48 x 96 x 83	48 x 96 x 83	48 x 96 x 83
Function	Microprocessor based indicator/controller, AC / DC ammeter, voltmeter, 3½-digit or 3-digit + dummy zero display	Microprocessor based indicator/controller, AC / DC ammeter, voltmeter, 3½-digit or 3-digit + dummy zero display	Microprocessor based indicator/controller, Temperature resistance Measur. in °C or °F, 3½-digit or 3-digit + dummy zero display
Input specifications			
Range code	Current: 2 mA DC, 20 mA DC Voltage: 200 mV DC, 20 VDC, 200 VDC [AV0]	Current: 2 AAC/DC, 5 AAC/DC Voltage: 200 VAC/DC, 500 VAC/DC [AV2]	Pt100, Ni100 [CFX]; Pt1000 [CFP]; TC-J-LK-S-T [CFX/CFP]; 200.0Ω [CFX]; 2000Ω [CFP]
Accuracy	±0.3% FS	DC: ±0.3% FS, AC: ±0.5% FS	TC, PT100/1000, resistance ±0.3% FS, Ni 100 ±0.5% FS
Indication	Max.	3½-dgt: 1999, 3+0-dgt: 9990	Depending on range and type of the temperature probe
	Min.	3½-dgt: -1999, 3+0-dgt: -1990	
Resistance			0 to 200 Ω (2000 Ω)
Range election / decimal point pos.	Programmable	Programmable	Programmable
Display refresh time	4 times/s	4 times/s	4 times/s
Functions			
	Password protection. Scaling factor. Diagnostics. Digital filter programm. Max. data hold.	Password protection. Scaling factor. Diagnostics. Digital filter programm. Max. data hold.	Password protection. Scaling factor. Diagnostics. Digital filter programm. Max. data hold.
Output specifications			
Setpoints	1 optional alarm [1] 5 A / 250 VAC / DC Excit. output 40 mA / 15 VDC [AX]	1 optional alarm [1] 5 A / 250 VAC / DC Excit. output 40 mA / 15 VDC [AX]	1 optional alarm [1] 5 A / 250 VAC / DC Excit. output 40 mA / 15 VDC [AX]
General specifications			
Power supply	120 [E], 230 [D], 240 [F], 24 [A], 48 [B], 115 [C] VAC, 9 - 32 [3] VDC, 40 - 150 [6] VDC	120 [E], 230 [D], 240 [F], 24 [A], 48 [B], 115 [C] VAC, 9 - 32 [3] VDC, 40-150 [6] VDC	120 [E], 230 [D], 240 [F], 24 [A], 48 [B], 115 [C] VAC, 9 - 32 [3] VDC, 40-150 [6] VDC
Option	IP65[IX], excit. out [AX], tropicalization [XT]	IP65[IX], excit. out [AX], tropicalization [XT]	IP65[IX], excit. out [AX], tropicalization [XT]
Safety Standards	EN 61010-1, IEC 61010-1, VDE0411	EN 61010-1, IEC 61010-1, VDE0411	EN 61010-1, IEC 61010-1, VDE0411
Approvals/Marks	CE - c CSA us	CE - c CSA us	CE - c CSA us
References			
For ordering key details, please refer to www.productselection.net			

Digital panel meters

Ammeters and voltmeters

Types

LDM 30

LDM 35 H

LDM 40



Dimensions HxWxD (mm)

48 x 96 x 83

48 x 96 x 83

48 x 96 x 83

Function

3-digit + dummy 0 μ P-based indicator, red LED display

3 1/2-digit μ P-based indicator and controller, 3 1/2-DGT or 3-DGT + dummy 0 red LED display

4-digit μ P-based indicator and controller

Input specifications

Range code	1A / 100 VAC [AV1]; 5A / 500 VAC [AV5]	(0.2-2-20 mA, 0.2-2-20 V) [LSE]; (0.2- 2-5 A, 20-200-500 V) [HSX]; DC and AC TRMS	(0.2-2-20 mA, 0.2-2-20 V) [LSE]; (0.2- 2-5 A, 20-200-500 V) [HSX]; DC and AC TRMS
Accuracy	$\pm 0.5\%$ FS, ± 1 DGT	DC: $\pm(0.3\%$ RDG + 3DGT) AC: $\pm(0.5\%$ RDG + 3DGT)	DC: $\pm(0.1\%$ RDG + 2DGT) AC: $\pm(0.3\%$ RDG + 2DGT)
Indication	Max.	9990	9999
	Min.	000	0 (AC) -9999 (DC) 4-digit LED red
Range selection / decimal point pos.	Selectable by dipswitch	Programmable	Programmable
Display refresh time	2 times/s	5 times/s	5 times/s

Functions

Signal / display scaling. Digital filter. Peak and valley.

Signal / display scaling. Digital filter. Peak and valley.

Output specifications

Up to 2 Alarm relay, [1-2]

Up to 2 Alarm relay, [1-2],
Analogue 0 to 20 mA,
0 to 10 V [AV],
RS485

General specifications



Power supply	24 / 48 VAC [B], 115 / 230 VAC [D]	90 to 260 VAC / DC [H], 18 to 60 VAC / DC [L]	90 to 260 VAC / DC [H], 18 to 60 VAC / DC [L]
Option	Tropicalization [XT], IP 65 [IX]	Tropicalization [TX]	Tropicalization [T]
Safety Standards	EN61010-1 IEC61010-1	EN61010-1 IEC61010-1	EN61010-1 IEC61010-1
Approvals/Marks	CE - c UR us - c CSA us	CE - c UR us - c CSA us	CE - c UR us - c CSA us

References





For ordering key details, please refer to www.productselection.net

Digital panel meters





Modular meter and conditioner

Types	UDM 35	UDM40/USC	UDM 60
			
Dimensions HxWxD (mm)	48 x 96 x 105	44 x 113 x 107 (USC) 48 x 96 x 105 (UDM40)	48 x 96 x 105
Function	MODULAR Microprocessor-based indicator / controller AC/DC Ammeter / Voltmeter / resistance / temperature measurement	MODULAR Microprocessor-based indicator / controller AC/DC Ammeter / Voltmeter / resistance / temperature measurement	MODULAR 6-DGT μ P-based controller
Input specifications			
Range code	0.2-2-20 mA DC/AC 0.2-2-20 VDC/AC [LSX] + AUX 13 VDC [LSE] or 25 VDC [LSF]; 0.2-2-5 A DC/AC; 20-200-500 V DC/AC [HSX]; TC: J-K-S-T-E, Pt100-250-500- 1000 [TRX]; 0.02-0.2-2-20 k Ω [TRX] 0.001 Hz to 50 Hz for DC signal [TF1] 0.001 Hz to 50 Hz for AC signal [TF2]	0.2-2-20 mA DC/AC 0.2-2-20 VDC/AC [LSX] + AUX 13 VDC [LSE] or 25 VDC [LSF]; 0.2-2-5 A DC/AC; 20-200-500 VDC/AC [HSX]; TC: J-K-S-T-E, Pt100-250-500- 1000 [TRX]; 0.02-0.2-2-20 k Ω [TRX] 0.001 Hz to 50 Hz for DC signal [TF1] 0.001 Hz to 50 Hz for AC signal [TF2]	Speed, frequency, rate, period, totalizer 0.001 Hz to 50 Hz for DC signal [TF1] 0.001 Hz to 50 Hz for AC signal [TF2]
Accuracy	0.1% RDG	0.1% RDG	$\pm(0.001\%RDG + 3DGT)$
Indication	Max. 1999 Min. 0 (AC) -1999 (DC), 3 1/2-digit LED red	9999 0 (AC) -9999 (DC), 4-digit LED. Colours: red, green, orange	9 999 999 0 6-DGT, LCD backlighted display
Range election / decimal	Programmable	Programmable	Programmable
Display refresh time	5 times/s	5 times/s	
Functions			
	Password protection. Scaling factor. Min Max data storage. Programmable digital filter. Range selection. Programmable via PC.	Password protection. Scaling factor. Min Max data storage. 16 linearization points. Programmable digital filter. Range selection. Programmable via PC.	Signal/display scaling. Analogue output scaling. Digital filter. Peak and valley. Linearization. Combination of the inputs according to predefined functions. Pulse metering and totalizing.
Output specifications			
Setpoints	Analogue 0 to 20 mA, 0 to 10 V [AV] Serial RS485 [SX], Serial RS232 [SY], Single relay output [R1], Dual relay output [R2], Dual relay + dual open coll. output [R4], Four relay output [R5]	Analogue 0 to 20 mA, 0 to 10 V [AV] Serial RS485 [SX], Serial RS232 [SY], Single relay output [R1], Dual relay output [R2], Dual relay + dual open coll. output [R4], Four relay output [R5]	Analogue 0 to 20 mA, 0 to 10 V [AV] Serial RS485 [SX], Serial RS232 [SY], Single relay output [R1], Dual relay output [R2], Dual relay + dual open coll. output [R4], Four relay output [R5]
General specifications			
Power supply	90 to 260 AC/DC [H], 18 to 60 VAC/DC [L] 10 to 28 VDC [3]	90 to 260 AC/DC [H], 18 to 60 VAC/DC [L] 10 to 28 VDC [3]	90 to 260 AC/DC [H], 18 to 60 VAC/DC [L] 10 to 28 VDC [3]
Option	Tropicalization [TX]	Tropicalization [TX]	Tropicalization [TX]
Safety Standards	EN 61010-1, IEC 61010-1	EN 61010-1, IEC 61010-1	EN 61010-1, IEC 61010-1
Approvals/Marks	CE - c UR us - c CSA us	CE - c UR us - c CSA us	CE - c UR us - c CSA us
References			
For ordering key details, please refer to www.productselection.net			

Converters and gateway

	Serial converter		Ethernet gateway	M-bus converter
Types	SIU-PC2	SIU-PC3	SIU-TCP2	VMU-B
				
Dimensions HxWxD (mm)	Front: 100 x 67	Front: 60 x 37.5	Front: 78 x 65	Front: 90 x 17.5
Function	RS422 / RS485 to RS232 converter	RS422 / RS485 to USB converter	Ethernet to RS232 / 485 Gateway	Modbus to M-bus converter
Port 1				
Port connections	RS232 9-pole, female	USB type A	Ethernet, 10 / 100 Mbps RJ45	RS485
Baud rate	Max 230400 Baud	Max 961.6 kBaud	Max 230400 Baud	
Port 2				
Port connections	RS422, RS485 2-wire and 4-wire communication	RS232, RS485 2-wire communication	RS232, RS485 2-wire and 4-wire communication	M-bus
General specifications				
Power supply	12 to 30 VDC Suggested adapter: SPD12-101 (120 to 240 VAC/DC)	Self supplied by USB port	9 to 30 VDC AD5V1A: AC / DC power supply adapter (on request)	18 to 260 VAC/DC
Approvals/Marks	CE - FCC	CE - FCC	CE	CE
References				
	SIU PC2	SIU PC3	SIU TCP2	VMUBM1US1B1X01
	SIU PC21 (2kV insulated)			VMUBM2US1B1B

Safety modules

	Emergency stop and safety gates			Two hand device
Types	NES02D	NES13D	NA13D	ND12D
				
Dimensions HxWxD (mm)	99 x 22.5 x 114	99 x 22.5 x 114	99 x 22.5 x 114	99 x 22.5 x 114
Safety category	Category 4 (EN ISO 13849-1:2008)	Category 4 (EN ISO 13849-1:2008)	Category 4 (EN ISO 13849-1)	Category 4 (EN ISO 13849-1:2008)
Performance level	PLe (EN ISO 13849-1:2008)	PLe (EN ISO 13849-1:2008)	PLe (EN ISO 13849-1)	PLe (EN ISO 13849-1:2008)

Function	Category 0 emergency stop module safety gates (mech. switches)	Category 0 emergency stop module safety gates (mech. switches)	Category 0 emergency stop module safety gates (mech. switches)	Two hand device
----------	--	--	--	-----------------

Output specifications

	2 x NO safety relay	3 x NO safety relay + 1 NC relay	3 x NO safety relay + 1 NC relay	2 x NO safety relay
Max. load AC1	6 A @ 230 VAC	6 A @ 230 VAC	6 A @ 230 VAC	6 A @ 230 VAC
Max. load DC12	6 A @ 24 VDC	6 A @ 24 VDC	6 A @ 230 VAC	6 A @ 24 VDC
Electrical life	> 10 ⁵ operations	> 10 ⁵ operations	> 10 ⁵ operations	> 10 ⁵ operations

Input specifications

Type	2 x NO, voltage free	2 x NO, voltage free	2 x NO, voltage free	2 x NO, 2 x NC, voltage free
------	----------------------	----------------------	----------------------	------------------------------



General specifications

Power supply	24 VAC / DC -15% +10%	24 VAC / DC -15% +10%	24 VAC/DC -15% +10% 110 VAC -15% +10% [110CG] 230 VAC -15% +10% [230CG]	24 VAC/DC -15% +10% 110 VAC -15% +10% [110CG] 230 VAC -15% +10% [230CG]
Screw terminals	Fixed [SA, SC] Detachable [DA, DC]	Fixed [SA, SC] Detachable [DA, DC]	Fixed	Fixed
Start	Automatic / Manual [SA, DA] Monitored manual [SC, DC]	Automatic / Manual [SA, DA] Monitored manual [SC, DC]	Automatic / Manual	Automatic
Approvals/Marks	CE - UL - TÜV	CE - UL - TÜV	CE	CE - UL - TÜV

References

	NES02DB24SA	NES13DB24SA	NA13D	ND12D
	NES02DB24SC	NES13DB24SC	NA13D110CG	ND12D110CG
	NES02DB24DA	NES13DB24DA	NA13D230CG	ND12D230CG
	NES02DB24DC	NES13DB24DC		

Safety modules

	Safety mat & edge		Safety light curtains
Types	NSE02C	NST02C	NLG02D / NLG13D
			
Dimensions HxWxD (mm)	80 x 22.5 x 99.5	80 x 22.5 x 99.5	99 x 22.5 x 114
Safety category	Category 3 (EN ISO 13849-1: 2008)	Category 3 (EN ISO 13849-1: 2008)	Category 4 (EN ISO 13849-1:2008)
Performance level	PLd (EN ISO 13849-1:2008)	PLd (EN ISO 13849-1:2008)	PLe (EN ISO 13849-1:2008)
Function	Safety mat & edge module	Safety mat module	Light curtains safety modules

Output specifications

	2 x NO safety relay	2 x NO safety relay	2 x NO safety relay [NLG02] 3 x NO safety relay + 1 NC relay [NLG13]
Max. load AC1	5 A @ 230 VAC	5 A @ 230 VAC	6 A @ 230 VAC
Max. load DC12	5 A @ 24 VDC	5 A @ 24 VDC	6 A @ 24 VDC
Electrical life	> 10 ⁵ operations	> 10 ⁵ operations	> 10 ⁵ operations

Input specifications

Type	2-wire mats or safety edges	4-wire mats (SM...)	2 x NO min 10 mA / 17 V max 60 mA / 38 V [NLG02] max 30 mA / 38 V
------	-----------------------------	---------------------	---

General specifications





Power supply	24 VAC/DC ±15%	24 VAC/DC ±15%	24 VDC - 15% +10%
Screw terminals	Fixed	Fixed	Fixed [SA, SC] Detachable [DA, DC]
Start	Automatic / Manual [SA, DA] Monitored manual [SC, DC]	Automatic / Manual [SA, DA] Monitored manual [SC, DC]	Automatic / Manual [SA, DA] Monitored manual [SC, DC]
Approvals/Marks	CE - TÜV	CE - TÜV	CE - UL - TÜV

References



	NSE02CB24SA	NST02CB24SA	NLG02D724SA
	NSE02CB24SC	NST02CB24SC	NLG02D724SC
			NLG02D724DA
			NLG02D724DC
			NLG13D724SA
			NLG13D724SC
			NLG13D724DA
			NLG13D724DC

Safety modules

Safety gates (magnetic sensors)

Types	NSO02	NSO13	NSC02	NSC13
				
Dimensions HxWxD (mm)	99 x 22.5 x 114	99 x 22.5 x 114	99 x 22.5 x 114	99 x 22.5 x 114
Safety category	Category 4 (EN ISO 13849-1:2008)	Category 4 (EN ISO 13849-1:2008)	Category 4 (EN ISO 13849-1:2008)	Category 4 (EN ISO 13849-1:2008)
Performance level	PLe (EN ISO 13849-1:2008)	PLe (EN ISO 13849-1:2008)	PLe (EN ISO 13849-1:2008)	PLe (EN ISO 13849-1:2008)
Function	Safety gates module	Safety gates module	Safety gates module	Safety gates module
Output specifications				
	2 x NO safety relay	3 x NO safety relay + 1 NC relay	2 x NO safety relay	3 x NO safety relay + 1 NC relay
Max. load AC1	6 A @ 230 VAC	6 A @ 230 VAC	6 A @ 230 VAC	6 A @ 230 VAC
Max. load DC12	6 A @ 24 VDC	6 A @ 24 VDC	6 A @ 24 VDC	6 A @ 24 VDC
Electrical life	> 10 ⁵ operations	> 10 ⁵ operations	> 10 ⁵ operations	> 10 ⁵ operations
Input specifications				
Type	2 x NO, SMS or mechanical	2 x NO, SMS or mechanical	1 x NO, 1 x NC, SMS or mechanical	1 x NO, 1 x NC, SMS or mechanical
General specifications				
Power supply	24 VAC/DC -15% +10%	24 VAC/DC -15% +10%	24 VAC/DC -15% +10%	24 VAC/DC -15% +10%
Screw terminals	Fixed [SA, SC] Detachable [DA, DC]	Fixed [SA, SC] Detachable [DA, DC]	Fixed [SA, SC] Detachable [DA, DC]	Fixed [SA, SC] Detachable [DA, DC]
Start	Automatic / Manual [SA, DA] Monitored manual [SC, DC]	Automatic / Manual [SA, DA] Monitored manual [SC, DC]	Automatic / Manual [SA, DA] Monitored manual [SC, DC]	Automatic / Manual [SA, DA] Monitored manual [SC, DC]
Approvals/Marks	CE - UL - TÜV	CE - UL - TÜV	CE - UL - TÜV	CE - UL - TÜV
References				
	NSO02DB24SA	NSO13DB24SA	NSC02DB24SA	NSC13DB24SA
	NSO02DB24SC	NSO13DB24SC	NSC02DB24SC	NSC13DB24SC
	NSO02DB24DA	NSO13DB24DA	NSC02DB24DA	NSC13DB24DA
	NSO02DB24DC	NSO13DB24DC	NSC02DB24DC	NSC13DB24DC

Safety modules

	Lift levelling		Extension
Types	NA12DLIFT	NXL12DG	NE14D
			
Dimensions HxWxD (mm)	99 x 22.5 x 114	99 x 22.5 x 114	99 x 22.5 x 114
Safety category			Category 4 (EN ISO 13849-1:2008)
Performance level			PL _e (EN ISO 13849-1:2008)
Function	Lift levelling module (EN 81-20, 81-50, EN 12015, EN 12016)	Lift levelling module (EN 81-20, 81-50, EN 12015, EN 12016)	Extension safety module
Output specifications			
	2 x NO safety relay	2 x NO safety relay 1 x NC auxiliary output	4 x NO safety relay + 1 NC (feedback)
Max. load AC1	6 A @ 230 VAC	6 A @ 230 VAC	6 A @ 230 VAC
Max. load DC12			6 A @ 24 VDC
Electrical life	> 10 ⁵ operations	> 10 ⁵ operations	> 10 ⁵ operations
Input specifications			
Type	4-wire 2 NO Channel with short-circuit detection	[NXL12DG002] 3-wire, 2 NO 1 common terminal [NXL12DG020] 4-wire, 2 NO channel with short-circuit detection	2 x NO, voltage free
General specifications			
Power supply	12 VAC/DC -15% +10% 24 VAC/DC -15% +10%	24 VAC/DC -15% +10%	24 VAC/DC -15% +10% 110 VAC -15% +10% [110CG] 230 VAC -15% +10% [230CG]
Screw terminals	Fixed	Fixed	Fixed
Start			
Approvals/Marks	CE - TÜV	CE - TÜV	CE
References			
	NA12DLIFT	NXL12DG002	NE14DCG
	NA12D12LIFT	NXL12DG020	NE14D110CG
			NE14D230CG

Configurable safety modules

Types	CERTUS Master Module
	CMM
	
Dimensions HxWxD (mm)	99 x 22.5 x 114
Safety level	Safety Integrity Level SIL 3, according to IEC 61508 Safety Integrity Level SIL CL 3, according to IEC 62061 Performance Level PL e and Cat. 4, according to ISO/EN 13489-1
Function	Can stand-alone managing and monitoring different safety sensors and commands at the same time. Manages up to 14 expansion units leaving out C2 R/C4 R modules

Safety inputs and outputs specifications

CMM as a stand alone unit	- 8 digital inputs, PNP active high according to EN 61131-2 - 2 pairs of solid state programmable safety outputs (OSSD), PNP active high 400 mA at 24 VDC max
Max. digital inputs with expansion modules	128
Max. digital outputs with expansion modules	16 pairs (OSSD)
Max. n° of expansion modules	14, leaving out C2 R/C4 R modules

Non-Safety inputs and outputs specifications

Test outputs	4
Programmable digital signal outputs	2
Input for Start/Restart interlock and EDM	2

General specifications

Rated voltage	24 VDC ±20% / supply from Class II
Digital inputs	PNP active high, according to EN 61131-2
OSSD	PNP active high - 400 mA @ 24 VDC (every OSSD)
Enclosure protection class	IP 20
Terminal blocks protection class	IP 2x

Types I/O Expansion Modules



	C 8I 2O	C 8I / C 16I	C 12I 8TO
			

Dimensions HxWxD (mm)	99 x 22.5 x 114		
Safety category	Category 4		
Performance level	PL e		
Function	expansion modules		

General specifications

PFHd (IEC 61508:1998)	5.72E-9	5.75E-9 [C 8I] 7.09E-9 [C 16I]	3.24E-9
Rated voltage	24 VDC ±20%		
Dissipated power	3 W max		
Digital inputs	8 / PNP active high according to EN 61131-2	PNP active high according to EN 61131-2 8 [C 8I] 16 [C 16I]	12 / PNP active high according to EN 61131-2
Test output	4 for sensor monitoring and checking short-circuits and overloads	4 for sensor monitoring and checking short-circuits and overloads	8 for sensor monitoring and checking short-circuits and overloads

Configurable safety modules



	OSSD + standard Relay Expansion Modules		Speed monitoring Modules	
Types	C 2OSSD / C 4OSSD	C 2R / C 4R	C PSS / C ES1 / C ES2	
				
Dimensions HxWxD (mm)	99 x 22.5 x 114	99 x 22.5 x 114	99 x 22.5 x 114	
Safety category	Category 4	Category 4	Category 4	
Performance level	PL e	PL e	PL e	
Rated voltage	24 VDC ±20%	24 VDC ±20%	24 VDC ±20%	

Function	Expansion modules	Expansion modules	<p>Can be used to control the following:</p> <ul style="list-style-type: none"> • Zero speed, Max. speed, Speed range; • Direction of movement, rotation/translation; <p>Up to 4 speed thresholds can be set for each logic output (axis). Each unit incorporates two logic outputs that can be configured using the software and is thus capable of controlling up to two independent axes</p>
----------	-------------------	-------------------	---

General specifications

PHFd (IEC 61508:1998)	3.16E-9 [C 2OSSD] / 3.44E-9 [C 4OSSD]
Dissipated power	3 W max
Digital output	PNP active high 2 [C 2OSSD]; PNP active high 4 [C 4OSSD]
Switching voltage	240 VAC
Switching current	6 A max
Contacts	2 NO + 1 NC [C 2R] connectable to 1 OSSD pair 4 NO + 2 NC [C 4R] connectable to 2 OSSD pairs
Feedback contacts	1 NC [C 2R] / 2 NC [C 4R]
Max number of axis	2
Max number of encoders	1 encoder [C ES1] / 2 encoders [C ES2]
Max number of proximity	2

Data and Diagnostics Communication + Bus Transfer Expansion Modules

Types	C DDC	C BT
		
Dimensions HxWxD (mm)	99 x 22.5 x 114	
Safety category	Category 4	
Performance level	PL e	
Rated voltage	24 VDC ±20%	



Function	Communication with most common industrial fieldbus system	Interface expansion module allowing the connection of remote expansions. Ideal solution for the interconnection of the safety functions of several machines in a production line
----------	---	--

General specifications

Connection	Shielded cable compatible with RS485
Max connection distance	50 m
Max number of CBT modules per system	6
References	<p>Profibus [C PFBUS] DeviceNET [C DNET] CANopen [C CAN] Ethernet IP [C EIP] EtherCAT [C ECAT] PROFINET [C PFNET] Universal Serial Bus [C OMMS]</p> <p>1 connection (1 input or 1 output) [C BT1] 2 connections (1 input and 1 output) [C BT2]</p> <p>The C BT1 is placed at the beginning or at the end of the network connected with a single cable, whilst the C BT2 goes in the middle.</p>

Switching power supplies

Single phase switching power supplies

Types	SPD 5 / 10 / 18 W				SPD 30 / 60 W			SPD 90 / 100 W		
										
Dimensions HxWxD (mm)	90 x 22.5 x 114				90 x 40.5 x 114			90 x 54 x 114		
Output specifications										
Voltage	5 VDC	12 VDC	15 VDC	24 VDC	12 VDC	24 VDC	48 VDC	12 VDC	24 VDC	48 VDC
Current SPD 5 W	1 A	420 mA	340 mA	210 mA						
Current SPD 10 W	2 A	840 mA	670 mA	420 mA						
Current SPD 18 W	3 A	1.5 A	1.2 A	750 mA						
Current SPD 30 W					2.5 A	1.25 A	625 mA			
Current SPD 60 W					5 A	2.5 A	1.25 A			
Current SPD 90 W										3.8 A
Current SPD 100 W								8.4 A	4.2 A	2.1 A
Line regulation		±1%			±0.5%			±1%		
Load regulation		±2%			±0.5%			±1%		
Efficiency	75%	77%	77%	77%	86%	89%	89%	85%		
Input specifications										
Voltage range	Multi voltage: 90 to 265 VAC or 120 to 370 VDC				Multi voltage: 85 to 264 VAC or 90 to 375 VDC			Multi voltage: 90 to 264 VAC or 120 to 375 VDC		
Frequency range	47 to 63 Hz				47 to 63 Hz			47 to 63 Hz		
General specifications										
Ambient temperature	-40°C to +71°C				-40°C to +71°C			-35°C to +71°C		
Storage	-40°C to +85°C				-40°C to +85°C			-40°C to +85°C		
Derating (>60°C)	3 % / °C				2.5 % / °C			2.5 % / °C		
Approvals/Marks	cULus - TÜV - CE - UL Class 2 - Class I DIV2				cULus - TÜV - CE - UL Class 2 - Class I DIV2			cULus - TÜV - CE - UL Class 2 (90W) - Class I DIV2		
Installation	DIN Rail				DIN Rail			DIN Rail		
Connection	Screw terminals / Spring terminals (B)				Screw terminals / Spring terminals (B)			Screw terminals / Spring terminals (B)		
Main features										
	Adjustable output voltage. Internal noise filter. Short circuit protection. Overload protection (110-135%).				Adjustable output voltage. Internal noise filter. Short circuit protection. Overload protection (110-135%). Output "Power ready" signal VDC (only model 24 VDC).			Adjustable output voltage. Internal noise filter. Short circuit protection. Overload protection (102-108%), PFC. Overvoltage protection (102-106%). Output "Power ready" signal VDC.		
LED indicator for "power on"	Yes				Yes			Yes		
LED indicator for DC "too low"	Yes				No - SPD24 with transistor output			Yes with relay output		
References										
5 VDC										
Screw terminals	SPD05051 / SPD05101 SPD05181									
Spring terminals	SPD05051B / SPD05101B SPD05181B									
12 VDC										
Screw terminals	SPD12051 / SPD12101 SPD12181				SPD12301 / SPD12601			SPD121001		
Spring terminals	SPD12051B / SPD12101B SPD12181B				SPD12301B / SPD12601B					
24 VDC										
Screw terminals	SPD24051 / SPD24101 SPD24181				SPD24301 / SPD24601			SPD24901L / SPD241001		
Spring terminals	SPD24051B / SPD24101B SPD24181B				SPD24301B / SPD24601B					
48 VDC										
Screw terminals					SPD48301 / SPD48601			SPD481001		
Spring terminals					SPD48301B / SPD48601B					

Switching power supplies

Single phase switching power supplies

Types	SPD 120 W / 120 W(N)			SPD 240 W		SPD 300 W		SPD 480 W	
									

Dimensions HxWxD (mm)	124.5 x 64 x 123.6			124.5 x 83.5 x 123.6		124.5 x 83.5 x 123.6		124.5 x 175.5 x 123.6	
-----------------------	--------------------	--	--	----------------------	--	----------------------	--	-----------------------	--

Output specifications

Voltage	12 VDC	24 VDC	48 VDC	24 VDC	48 VDC	24 VDC	48 VDC	24 VDC	48 VDC
Current	10 A	5 A	2.5 A	10 A	5 A	12.5 A	6.25 A	20 A	10 A
Line regulation		±0.5%	±0.5%		±0.5%		±0.5%		±0.5%
Load regulation		±1%	±1%		±1%		±1%		±1%
Efficiency	84%	86%	86%	89%	90%	89%	90%	89%	90%

Input specifications

Voltage range	Autoselect: 90 to 132 VAC, 180 to 264 VAC, 120 to 375 VDC			Autoselect: 90 to 132 VAC, 180 to 264 VAC, 120 to 375 VDC		Autoselect: 90 to 132 VAC, 180 to 264 VAC, 120 to 375 VDC		Autoselect: 90 to 132 VAC, 186 to 264 VAC, 120 to 370 VDC	
Frequency range	47 to 63 Hz			47 to 63 Hz		47 to 63 Hz		47 to 63 Hz	
PFC	0.7			0.75		0.75		0.99	

General specifications

Ambient temperature	-35°C to +71°C			-40°C to +71°C		-30°C to +71°C		-40°C to +71°C	
Storage	-40°C to +85°C			-40°C to +85°C		-40°C to +85°C		-40°C to +85°C	
Derating (>60°C)	2.5 % / °C			2.5 % / °C		2.5 % / °C		2.5 % / °C > 56°C	
Approvals/Marks	cULus - TÜV - CE - Class I DIV2			cULus - TÜV - CE - Class I DIV2		cULus - TÜV - CE - Class I DIV2		cULus - TÜV - CE - Class I DIV2	
Installation	DIN Rail			DIN Rail		DIN Rail		DIN Rail	
Connection	Screw terminals / Spring terminals (B)			Screw terminals / Spring terminals (B)		Screw terminals / Spring terminals (B)		Screw terminals / Spring terminals (B)	

Main features





	Adjustable output voltage. Internal noise filter. Short circuit protection. Overload protection (110-145%). Parallel connection up to 3 supplies and PFC function on (N) model only	Adjustable output voltage. Internal noise filter. Short circuit protection. Overload protection (110-145%). Parallel connection up to 3 supplies standard. PFC function integrated	Parallel function, PFC and Output ready	Adjustable output voltage. Internal noise filter. Short circuit protection. Overload protection (120-140%). Parallel connection up to 3 supplies standard. PFC function integrated
LED indicator for "power on"	Yes	Yes	Yes, 24 V with output ready	Yes
LED indicator for DC "too low"	Yes - with relay output (SPD24 only)	Yes - with relay output (SPD24 only)	Yes	Yes - with relay output (SPD24 only)

References



12 VDC				
Screw terminals	SPD121201 SPD121201N			
Detatch. screw terminals	SPD121201B SPD121201BN			
24 VDC				
Screw terminals	SPD241201 SPD241201N	SPD242401	SPD243001	SPD244801
Detatch. screw terminals	SPD241201B SPD241201BN	SPD242401B	SPD243001B	SPD244801B
48 VDC				
Screw terminals	SPD481201 SPD481201N	SPD482401	SPD483001	SPD484801
Detatch. screw terminals	SPD481201B SPD481201BN	SPD482401B	SPD483001B	SPD484801B

Switching power supplies

Three phase switching power supplies





Types	SPD 120 W 3-ph		SPD 240 W 3-ph		SPD 480 W 3-ph		SPD 960 W 3-ph	
								
Dimensions HxWxD (mm)	124 x 74.3 x 118.8		124 x 89.0 x 118.8		124 x 150 x 118.8		126.2 x 275.8 x 118.8	
Output specifications								
Voltage	12 VDC	24 VDC	24 VDC	48 VDC	24 VDC	48 VDC	24 VDC	48 VDC
Current	10 A	5 A	10 A	5 A	20 A	10 A	40 A	20 A
Line regulation	±1%		±1%		±1%		±1%	
Load regulation	±1%		±1%		±1%		±1%	
Efficiency	87%	89%	90%	91%	90%	91%	92%	93%
Input specifications								
Voltage range	340 to 575 VAC 480 to 820 VDC		340 to 575 VAC 480 to 820 VDC		340 to 575 VAC 480 to 820 VDC		340 to 575 VAC 480 to 820 VDC	
Frequency range	47 to 63 Hz		47 to 63 Hz		47 to 63 Hz		47 to 63 Hz	
PFC	0.55		0.55		0.65		0.80	
General specifications								
Ambient temperature	-40°C to +71°C		-25°C to +71°C		-30°C to +71°C		-40°C to +71°C	
Storage	-40°C to +85°C		-25°C to +85°C		-40°C to +85°C		-40°C to +85°C	
Derating	2.5 % / °C > 61°C		2.5 % / °C > 61°C		2.5 % / °C > 61°C		3.5 % / °C > 61°C	
Approvals/Marks	cULus - TÜV - CE - Class I Div 2		cULus - TÜV - CE - Class I Div 2		cULus - TÜV - CE - Class I Div 2		cULus - TÜV - CE - Class I Div 2	
Installation	DIN Rail		DIN Rail		DIN Rail		DIN Rail	
Connection	Screw terminals		Screw terminals		Screw terminals / Detach conn.		Screw terminals	
Main features								
	Can be used as Bi or Three phase, Parallel function and PFC		Can be used as Bi or Three phase, Parallel function and PFC		Can be used as Bi or Three phase, Parallel function and PFC		Can be used as Bi or Three phase. Active parallel function and PFC	
LED indicator for "power on"	Yes, 24 V with output ready		Yes, 24 V with output ready		Yes, 24 V with output ready		Yes, 24 V with output ready	
LED indicator for DC "too low"	Yes		Yes		Yes		Yes	
References								
12 VDC								
Screw terminals	SPD121203							
24 VDC								
Screw terminals	SPD241203	SPD242403	SPD244803	SPD249603 SPD249603L (without parallel function and output ready)				
48 VDC								
Screw terminals	SPD482403		SPD484803		SPD489603			

Switching power supplies, redundant modules

	Bi-phase switching power supplies			Redundant modules	
Types	SPD 100 W			SPD Redundant Module	SPM Redundant Module
					
Dimensions HxWxD (mm)	90 x 54 x 114			90 x 54 x 114	91 x 35 x 56
Output specifications					
Voltage	12 VDC	24 VDC	48 VDC	24 VDC	24 VDC
Current	8.4 A	4.2 A	2.1 A	20 A	10 A
Line regulation	±1%				
Load regulation	±1%				
Efficiency	86%	87%	89%		
Input specifications					
Voltage range	340 to 575 VAC, 480 to 820 VAC			21 to 28 VDC	21 to 48 VDC
Frequency range	47 to 63 Hz				
PFC	0.55				
General specifications					
Ambient temperature	-40°C to +71°C			-40°C to +71°C	
Storage	-40°C to +85°C			-40°C to +85°C	
Derating (>60°C)	2.5% / °C				
Approvals/Marks	cULus - TÜV - CE - Class I DIV2			cULus - TÜV - CE	CE
Installation	DIN Rail			DIN Rail	DIN Rail
Connection	Screw terminals			Screw terminals	Screw terminals
Main features					
	Parallel function, PFC and Output ready			2 Relay outputs for remote monitoring	
LED indicator for "power on"	Yes - with relay output (SPD24 only)			Yes - with relay output (SPD24 only)	
LED indicator for DC "too low"	Yes				
References					
12 VDC					
Screw terminals	SPD121002				
24 VDC					
Screw terminals	SPD241002			SPD24RM20	SPM2RM2410
48 VDC					
Screw terminals	SPD481002				

Switching power supplies

Low profile DIN rail mounting

Types	SPM 1 7.5 W to 10 W	SPM 3 15 W to 30 W	SPM 4 35 W to 60 W	SPM 5 60 W to 100 W
				
Dimensions HxWxD (mm)	91 x 18 x 55.5	91 x 52 x 55.5	91 x 71 x 55.5	91 x 90 x 55.5
Output specifications				
Voltage	5 VDC, 12 VDC, 15 VDC, 24 VDC	5 VDC, 12 VDC, 15 VDC, 24 VDC	5 VDC, 12 VDC, 15 VDC, 24 VDC	5 VDC, 12 VDC, 15 VDC, 24 VDC, 24 VDC (S ver.)
Current	1.5 A - 0.83 A 0.67 A - 0.42 A	3.0 A - 2.1 A 2.0 A - 1.3 A	7.0 A - 4.5 A 4.0 A - 2.5 A	12 A - 6 A - 5 A 4.2 A - 3.8 A
Output Power	5 V - 7.5 W 12 V, 15 V, 24 V - 10 W	5 V - 15 W 12 V - 25 W 15 V, 24 V - 30 W	5 V - 35 W 12 V - 54 W 15 V, 24 V - 60 W	5 V - 60 W 12 V - 72 W 15 V - 75 W 24 V - 100 W or 24 V - 91 W (for class 2 compliance)
Line regulation	±1%	±1%	±1%	±1%
Load regulation	±1%	±1%	±1%	±1%
Input specifications				
Voltage range	Autoselec.. 90 to 264 VAC, 120 to 370 VDC	Autoselec.. 90 to 264 VAC, 120 to 370 VDC	Autoselec.. 90 to 264 VAC, 120 to 370 VDC	Autoselec.. 90 to 264 VAC, 120 to 370 VDC
Frequency range	47 to 63 Hz	47 to 63 Hz	47 to 63 Hz	47 to 63 Hz
General specifications				
Ambient temperature	-25°C to +71°C	-25°C to +71°C	-25°C to +71°C	-25°C to +71°C
Storage	-25°C to +85°C	-25°C to +85°C	-25°C to +85°C	-25°C to +85°C
Derating (>60°C)	2.5 % / °C	2.5 % / °C	2.5 % / °C	2.5 % / °C
Approvals/Marks	cULus - TÜV - CE - UL Class 2 - Class I DIV2	cULus - TÜV - CE - UL Class 2 - Class I DIV2	cULus - TÜV - CE - UL Class 2 - Class I DIV2	cULus - TÜV - CE - UL Class 2 (up to 91 W) - Class I DIV2
Installation	DIN Rail	DIN Rail	DIN Rail	DIN Rail
Connection	Screw terminals	Screw terminals	Screw terminals	Screw terminals
Main features				
		Adjustable output voltage	Adjustable output voltage	Adjustable output voltage
LED indicator for "power on"	Yes	Yes	Yes	Yes
LED indicator for DC "too low"	Yes	Yes	Yes	Yes
References				
5 VDC	SPM1-051	SPM3-051	SPM4-051	SPM5-051
12 VDC	SPM1-121	SPM3-121	SPM4-121	SPM5-121
15 VDC	SPM1-151	SPM3-151	SPM4-151	SPM5-151
24 VDC	SPM1-241	SPM3-241	SPM4-241	SPM5-241
24 VDC (Class 2 UL)				SPM5-241S

Switching power supplies

Enclosed switching power supplies

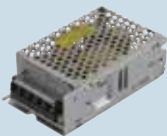
Types	SPPC 25 W	SPPC 35 W	SPPC 50 W	SPPC 75 W
				
Dimensions HxWxD (mm)	79 x 51 x 28.8	101.6 x 63.5 x 33	99 x 82 x 35	129 x 98 x 38
Output specifications				
Voltage	5 V, 12 V, 24 V	5 V, 12 V, 24 V	5 V, 12 V, 15 V, 24 V, 48 V	5 V, 12 V, 24 V, 48 V
Current	5 A, 2.1 A, 1.1 A	6 A, 3 A, 1.5 A	8 A, 4.2 A, 3.4 A, 2.2 A, 1.12 A	12 A, 6 A, 3.2 A, 1.62 A
Line regulation	±0.5%	±0.5%	±0.5%	±0.5%
Load regulation	±2.0%, ±1.0%, ±1.0%	±1.0%	±1.0%	±2.0%
Efficiency (typ)	115 VAC 230 VAC	76%, 80%, 84% 78%, 82%, 85%	79%, 83%, 86% 80%, 84%, 87%	79%, 84%, 87%, 88% 80%, 85%, 88%, 89%
Input specifications				
Voltage range	90 to 264 VAC 127 to 370 VDC	90 to 264 VAC 127 to 370 VDC	90 to 264 VAC 27 to 370 VDC	90 to 264 VAC 127 to 370 VDC
Frequency range	47 to 63 Hz	47 to 63 Hz	47 to 63 Hz	47 to 63 Hz
General specifications				
Ambient temperature	-25°C to +70°C	-25°C to +70°C	-25°C to +70°C	-25°C to +70°C
Storage	-40°C to +85°C	-40°C to +85°C	-40°C to +85°C	-40°C to +85°C;
Derating (>50°C)	2% / °C	2% / °C	1.5% / °C	1.5% / °C
Cooling	Free air convection	Free air convection	Free air convection	Free air convection
Approvals/Marks	CE - cURus	CE - cURus	CE - cURus	CE - cURus
Installation	Screw terminal	Screw terminal	Screw terminal	Screw terminal
Main features				
Mounting	Horizontal and Vertical (DIN rail mounting accessories available)	Horizontal and Vertical (DIN rail mounting accessories available)	Horizontal and Vertical (DIN rail mounting accessories available)	Horizontal and Vertical (DIN rail mounting accessories available)
References				
5 VDC	SPPC 525 1	SPPC 535 1	SPPC 550 1	SPPC 575 1
12 VDC	SPPC 1225 1	SPPC 1235 1	SPPC 1250 1	SPPC 1275 1
15 VDC			SPPC 1550 1	
24 VDC	SPPC 2425 1	SPPC 2435 1	SPPC 2450 1	SPPC 2475 1
48 VDC			SPPC 4850 1	SPPC 4875 1

Switching power supplies

Compact enclosed switching power supplies

Types	SPPC 100 W	SPPC 150 W	SPPC 150 W (PFC) Power Factor Correction	SPPC 150 W PFC Compact
				

Dimensions HxWxD (mm)	129 x 98 x 38	199 x 98 x 38	194 x 99 x 50	160 x 98 x 38
-----------------------	---------------	---------------	---------------	---------------

Output specifications

Voltage	5 V, 12 V, 24 V, 48 V	5 VDC, 12 VDC, 15 VDC, 24 VDC, 48 VDC	5 VDC, 12 VDC, 15 VDC, 24 VDC, 48 VDC	5 VDC, 12 VDC, 15 VDC, 24 VDC, 48 VDC
Current	20 A, 8.5 A, 4.2 A, 2.2 A	26 A, 12.5 A, 10 A, 6.5 A, 3.3 A	30 A, 12.5 A, 10 A, 6.3 A, 3.2 A	12.5 A, 10 A, 6.3 A, 3.2 A
Line regulation	±0.5%	±0.5%	±0.5%	±0.5%
Load regulation	±2% (5, 12 V) ±1% (24, 48 V)	±1%	±1%	±2%, ±2%, ±1%, ±1%
Efficiency (typ)	84%, 87%, 88%, 88%	up to 85%	up to 87%	86%, 87%, 87%, 88%
Built-in active PFC			PFC > 0.98 @ 115 VAC; PFC > 0.95 @ 230 VAC	Active PFC, PF > 0.95

Input specifications

Voltage range	90 to 264 VAC 127 to 370 VDC	88 to 132 VAC 176 to 264 VAC 124 to 186 VDC 248 to 370 VDC	88 to 264 VAC 124 to 370 VDC	90 to 264 VAC 120 to 370 VDC
Frequency range	47 to 63 Hz	47 to 63 Hz	47 to 63 Hz	47 - 63 VAC

General specifications

Ambient temperature	-25°C to +70°C	-25°C to +70°C	-25°C to +70°C	-20°C to +70°C
Storage	-40°C to +85°C	-40°C to +85°C	-30°C to +85°C	-30°C to +85°C
Output short circuit		Long-term, Auto recovery	Long-term, Auto recovery	Long-term, Auto recovery
Derating (>50°C)	See derating curve	2.5% / °C	2.5% / °C	Refer to derating diagram
Cooling	Free air convection	Free air convection	Free air convection	Free air convection
Approvals/Marks	CE - cURus	CE - cURus	CE - cURus	CE - cURus
Installation	Screw terminal	Screw terminal	Screw terminal	Screw terminal

Main features





Mounting	Horizontal and Vertical (DIN rail mounting accessories available)	Horizontal and Vertical (DIN rail mounting accessories available)	Horizontal and Vertical (DIN rail mounting accessories available)	Horizontal and Vertical (DIN rail mounting accessories available)
----------	---	---	---	---

References



5 VDC	SPPC51001	SPPC-5150 1	SPPC-5150 1F	
12 VDC	SPPC121001	SPPC-12150 1	SPPC-12150 1F	SPPC-12150 1FC
15 VDC		SPPC-15150 1	SPPC-15150 1F	SPPC-15150 1FC
24 VDC	SPPC241001	SPPC-24150 1	SPPC-24150 1F	SPPC-24150 1FC
48 VDC	SPPC481001	SPPC-48150 1	SPPC-48150 1F	SPPC-48150 1FC

Switching power supplies

Compact enclosed switching power supplies



Types	SPPC 200 W	SPPC 240 W	SPPC 320 W	SPPC 480 W
				
Dimensions HxWxD (mm)	199 x 99 x 50	199 x 99 x 50	199 x 99 x 50	218 x 116.5 x 41
Output specifications				
Voltage	5 V, 12 V, 24 V, 48 V	12 V, 24 V	5 V, 12 V, 24 V, 48 V	12 V, 24 V, 36 V, 48 V
Current	40 A, 16.7 A, 8.4 A, 4.2 A	20 A, 10 A	55 A, 25 A, 13 A, 6.7 A	34 A, 22 A, 14 A, 11 A
Line regulation	±0.5%	±0.5%	±0.5%	±0.5%, ±0.5%, ±0.5%, ±0.2%
Load regulation	±1.0%	±1.0%	±1.0%	±1.0%
Efficiency (typ)	79%, 84%, 86%, 87.5%	84%, 86%	79%, 84.5%, 87%, 87.5%	88%, 89%, 90%, 90%
Built-in active PFC	(115 VAC): PF>0.98 (230 VAC): PF>0.96	(115 VAC): PF>0.98 (230 VAC): PF>0.96	(115 VAC): PF>0.98 (230 VAC): PF>0.96	(115 VAC): PF>0.98 (230 VAC): PF>0.96
Input specifications				
Voltage range	85 to 264 VAC 120 to 370 VDC	85 to 264 VAC 120 to 370 VDC	85 to 264 VAC 120 to 370 VDC	90 to 264 VAC 127 to 370 VAC
Frequency range	47 to 63 Hz	47 to 63 Hz	47 to 63 Hz	47 to 63 Hz
General specifications				
Ambient temperature	-25°C to +70°C	-25°C to +70°C	-25°C to +70°C	-30°C to +70°C
Storage	-40°C to +85°C	-40°C to +85°C	-40°C to +85°C	-40°C to +85°C
Output short circuit	Long-term, Auto recovery	Long-term, Auto recovery		
Derating (>50°C)	2% / °C	2% / °C	2% / °C	2% / °C
Cooling	Forced air (built-in DC fan controlled by load and internal temperature)	Forced air (built-in DC fan controlled by load and internal temperature)	Forced air (built-in DC fan controlled by load and internal temperature)	Forced air (built-in DC fan controlled by load and internal temperature)
Approvals/Marks	CE - cURus	CE - cURus	CE - cURus	CE - cURus
Installation	Screw terminal	Screw terminal	Screw terminal	Screw terminal
Main features				
Mounting	Horizontal and Vertical (DIN rail mounting accessories available)	Horizontal and Vertical (DIN rail mounting accessories available)	Horizontal and Vertical (DIN rail mounting accessories available)	Horizontal and Vertical (DIN rail mounting accessories available)
References				
5 VDC	SPPC 5200 1FC		SPPC 5320 1FC	
12 VDC	SPPC 12200 1FC	SPPC 12240 1FC	SPPC 12320 1FC	SPPC 12480 1FC
15 VDC				SPPC 24480 1FC
24 VDC	SPPC 24200 1FC	SPPC 24240 1FC	SPPC 24320 1FC	SPPC 36480 1FC
48 VDC	SPPC 48200 1FC		SPPC 48320 1FC	SPPC 48480 1FC

Switching power supplies

	Compact enclosed switching power supplies		Compact DIN Rail power supplies	
Types	SPPC 600 W	SPPC 800 W	SPDM 30 / 50 / 75 W	SPDM 120 W
				
Dimensions HxWxD (mm)	218 x 116.5 x 41	226 x 116.5 x 41	90 x 22.5 x 100 90 x 30 x 100 90 x 40.5 x 100	124 x 45 x 119
Output specifications				
Voltage	12 V, 24 V, 36 V, 48 V	24 V, 48 V	12 V, 24 V	24 V
Current	(100 to 127 VAC): 34 A, 22 A, 14 A, 11 A (128 to 264 VAC): 42 A, 26.5 A, 17.5 A, 13.6 A	(100 to 127 VAC): 27 A, 14 A (128 to 264 VAC): 33 A, 16.5 A	SPDM 30: 2 A, 1.25 A SPDM 50: 4 A, 2.1 A SPDM 75: 5.5 A, 3 A	5 A
Line regulation	±0.5%	±0.5%	±1.0%	±0.5%
Load regulation	±1.0%	±1.0%	±1.0%	±1.0%
Efficiency (typ)	88%, 89%, 90%, 90%	88%, 89%	from 85% to 89%	88%
Built-in active PFC	(115 VAC): PF>0.98 (230 VAC): PF>0.96	(115 VAC): PF>0.98 (230 VAC): PF>0.96		
Input specifications				
Voltage range	90 to 264 VAC 127 to 370 VAC	90 to 264 VAC 127 to 370 VAC	85 to 264 VAC 120 to 375 VDC	90 to 264 VAC 127 to 370 VDC
Frequency range	47 to 63 Hz	47 to 63 Hz	47 to 63 Hz	47 to 63 Hz
General specifications				
Ambient temperature	-30°C to +70°C	-30°C to +70°C	-25°C to +70°C	-20°C to +70°C
Storage	-40°C to +85°C	-40°C to +85°C	-40°C to +85°C	-40°C to +85°C
Output short circuit	Yes	Yes	Yes	Yes
Derating (>50°C)	2% / °C	2% / °C	2.5% / °C	Refer to datasheet diagram
Cooling	Forced air (built-in DC fan controlled by load and internal temperature)	Forced air (built-in DC fan controlled by load and internal temperature)	Natural air convection	Natural air convection
Approvals/Marks	CE - cURus	CE - cURus	CE - cURus	CE
Installation	Screw terminal	Screw terminal	Screw or spring terminals	Screw terminals
Main features				
Mounting	Horizontal and Vertical (DIN rail mounting accessories available)	Horizontal and Vertical (DIN rail mounting accessories available)	DIN rail	DIN rail
References				
12 VDC	SPPC 12600 1FC			
15 VDC	SPPC 24600 1FC	SPPC 24800 1FC		
24 VDC	SPPC 36600 1FC			SPDM241201
48 VDC	SPPC 48600 1FC	SPPC 48800 1FC		
			For ordering key details, please refer to www.productselection.net	

Switching power supplies, backup systems

High Compactness DIN Rail power supplies

Types	SPDC 120 W	SPDC 240 W
		
Dimensions HxWxD (mm)	124 x 32 x 119	124 x 45 x 119
Output specifications		
Voltage	12 V, 24 V	24 V
Current	10 A, 5 A	10 A
Line regulation	±0.5%	±0.5%
Load regulation	±1.0%	±1.0%
Efficiency (typ)	from 89.5% to 91%	88%
Built-in active PFC	>0.95	>0.95
Input specifications		
Rated input voltage	110 VAC - 240 VAC	110 VAC - 240 VAC
Voltage range	90 to 264 VAC 127 to 370 VDC	90 to 264 VAC 127 to 370 VDC
Frequency range	47 to 63 Hz	47 to 63 Hz
General specifications		
Ambient temperature	-25°C to 70°C	-25°C to 70°C
Storage	-40°C to 85°C	-40°C to 85°C
Output short circuit	Yes	Yes
Derating (>50°C)	Refer to datasheet diagram	Refer to datasheet diagram
Cooling	Free air convection	Free air convection
Approvals/Marks	CE - cULus	CE - cULus
Installation	Screw terminals	Screw terminal
Main features		
Mounting	DIN rail mounting	DIN rail mounting
DC OK Out	SPST relay	SPST relay
References		
12 VDC	SPDC121201	
24 VDC	SPDC241201	SPDC242401

Switching power supplies, backup systems

	UPS controller	Switching power supply and UPS	Low profile DIN battery charger	Battery Racks for UPS and chargers
Types	SPUC	SPUBC	SPM5BC	SPUBAT 24V
				

Dimensions HxWxD (mm)	90 x 54 x 114	115 x 65 x 135	91 x 90 x 57	175 x 62 x 120 200 x 82 x 160 210 x 145 x 130 210 x 210 x 210
-----------------------	---------------	----------------	--------------	--

Output specifications

Voltage	12 / 24 VDC	24 VDC	12 V / 24 V	24 VDC
Charging voltage	12 V Model Min. 9.1 VDC ~ 13.75 VDC Max. 24 V Model Min. 18.7 VDC ~ 28 VDC Max.	27.5 VDC (Std.), 28.8 VDC (Boost)	13.6 VDC / 27.2 VDC	
Power supply Current	30 A	5 A + 5 A with battery charged + 5 A for 4 s	30 W / 60 W	
Charging current max	2.5 A	5 A	1.25 A - 2.5 A 30 W / 2.5 A - 5 A 60 W	120 mA, 320 mA, 720 mA, 1.2 A
Battery Capacity				1.2 / 3.2 / 7.2 / 12 Ah
Battery Type				AGM VRLA

Input specifications

Rated Voltage input	12 / 24 VDC	115 VAC, 230 VAC, 277 VAC	110 VAC / 240 VAC	24 V
Voltage range	12 V Model 11 VDC to 14 VDC 24 V Model 22.5 VDC to 28 VDC	90 to 305 VAC	90 to 264 VAC 120 to 375 VDC	27.5 @ 20°C 26.8 @ 30°C 26.1 @ 40°C VDC End of charge voltage (trickle)
Frequency range		47 to 63 Hz	47 to 63 Hz	
Max Charging Current				0.36 / 0.9 / 2.16 A

General specifications

Ambient temperature	-40°C to +71°C	-25°C to +70°C	-40°C to +51°C	0°C to +40°C
Storage	-40°C to +85°C	-40°C to +85°C	-40°C to +85°C	0°C to +40°C
Derating (+51°C to +70°C)	2.5% /°C	Refer to datasheet diagram	Refer to datasheet diagram	
Cooling	Free air convection	Free air convection	Free air convection	Free air convection
Approvals/Marks	CE - cURus - TÜV	CE - cURus	CE - TÜV	CE
Installation	Screw terminal	Screw terminal	Screw terminal	Screw terminal

Main features

Mounting	DIN rail mounting	DIN rail mounting	Horizontal and Vertical (DIN rail mounting accessories available)	Wall / DIN rail mounting
Battery diagnosys	No	Yes	No	
DC OK Out	Yes	Yes	No	
Battery OK Out	Yes	Yes	No	
Mains / Backup Out	Yes	Yes	Yes	

References

12 V 30 A max	SPUC12360			
24 V 30 A max	SPUC24720			
PS + UPS 24V 120W		SPUBC24120		
12V 30W			SPM5BC 1230	
24V 30W			SPM5BC 2430	
12V 60W			SPM5BC 1260	
24V 60W			SPM5BC 2460	
24 V 1.2 Ah Battery				SPUBAT241A2
24 V 3.2 Ah Battery				SPUBAT243A2
24 V 7.2 Ah Battery				SPUBAT247A2
24 V 12 Ah Battery				SPUBAT2412A

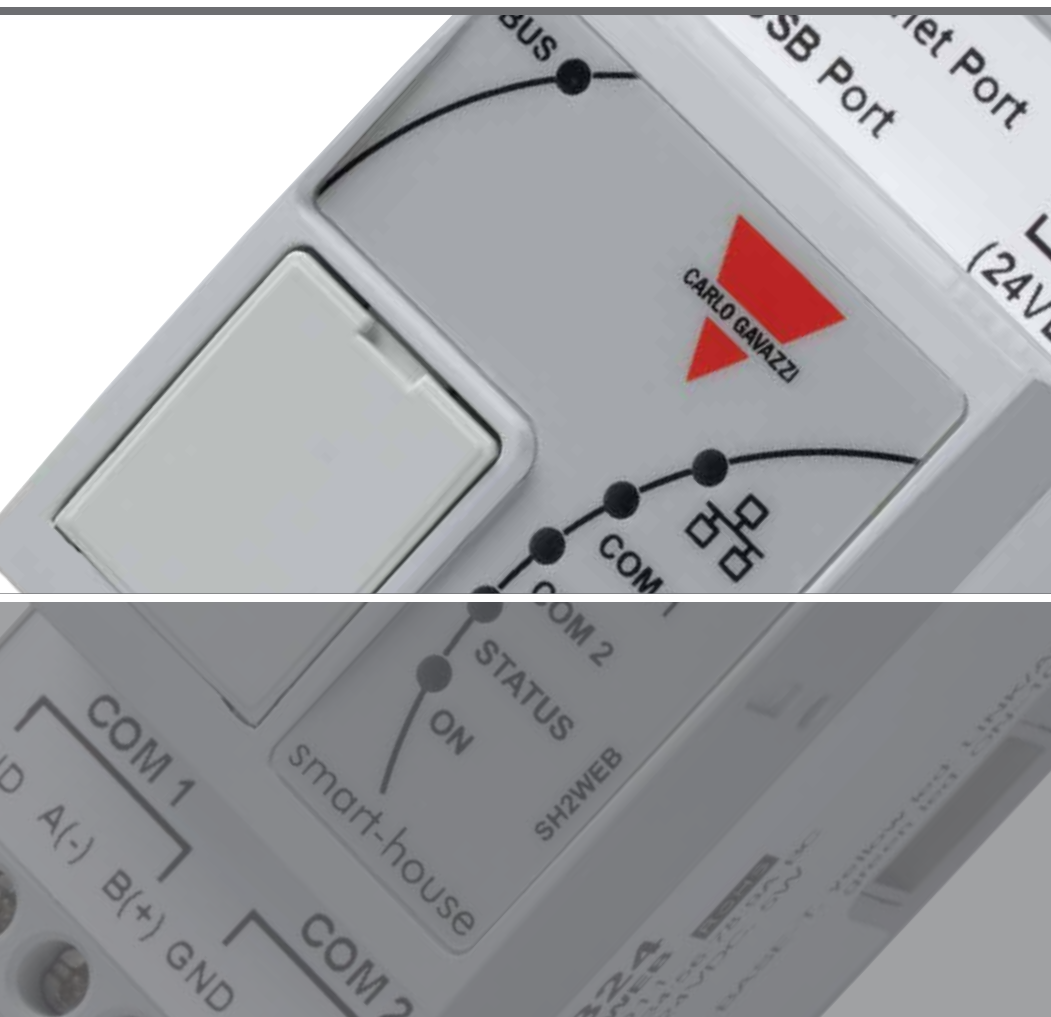

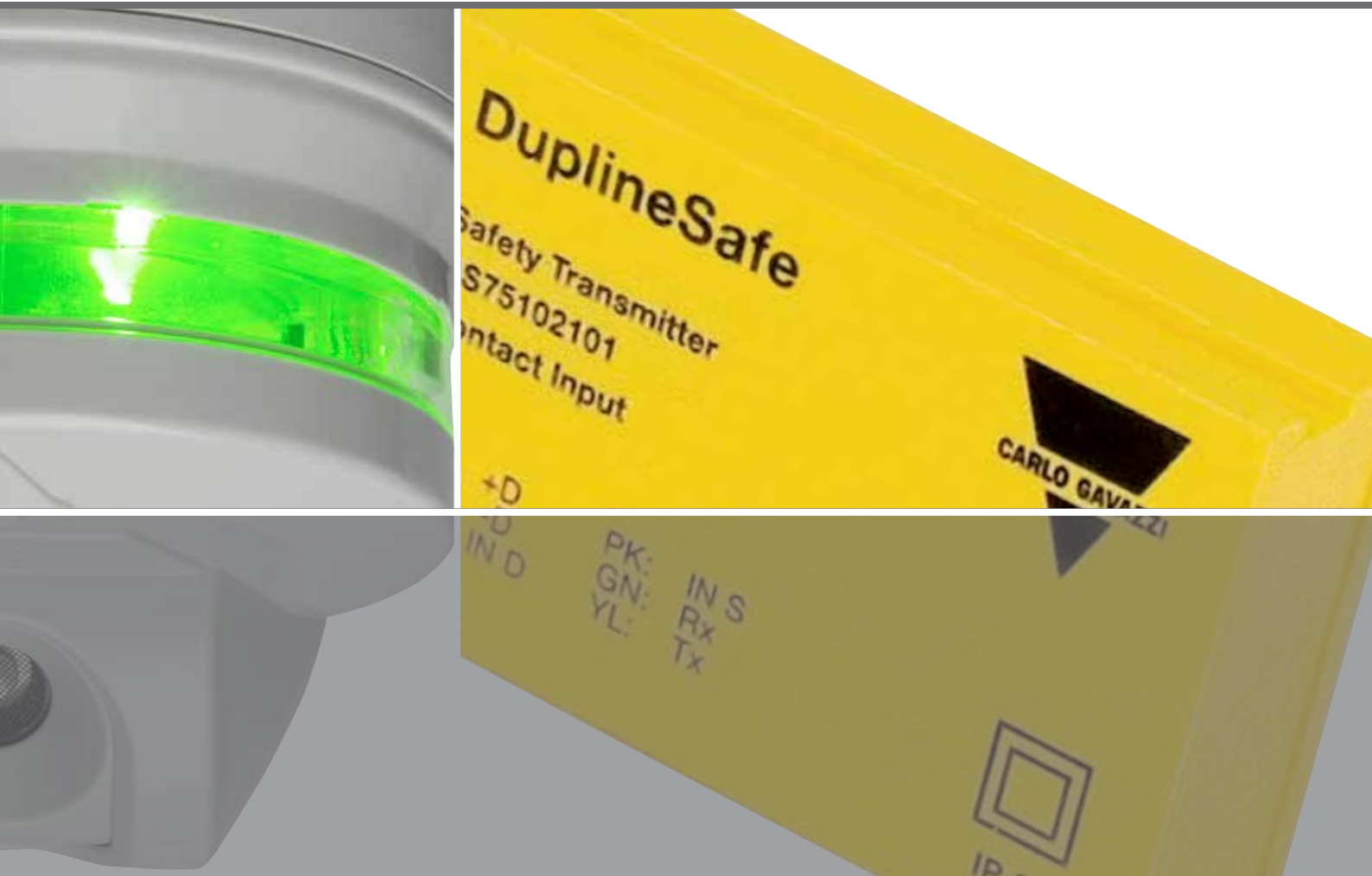

Fieldbuses





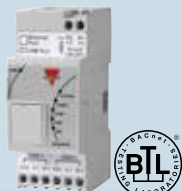

Dupline® Home and Building automation	246
Dupline® Parking guidance system	262
Dupline® DuplineSafe	265
Dupline® Industrial	267
Dupline® Irrigation	280
Dupline® Elevator	281

Dupline® Home and Building automation

	Controller		Bus generators	
Function	Home	Building	Wired	Wired
				
Dimensions (mm)	2-DIN module	2-DIN module	2-DIN module	2-DIN module
Functions	Controller with home/building automation functions and energy data logging configurable by software	BACnet controller, BTL certified, converting Dupline® and Energy Meter data points to BACnet/IP objects	Smart Dupline® generator	Dupline® generator
Electrical specifications				
Power supply	24 VDC ± 20%	24 VDC ± 20%	24 VDC ± 20%	24 VDC ± 20%
General specifications				
LEDs	Green, yellow, blue, red	Green, yellow, blue, red	Green, yellow	Green, yellow
Mounting	DIN-rail (2 modules)	DIN-rail (2 modules)	DIN-rail (2 modules)	DIN-rail (2 modules)
Degree of protection	Front: IP 40 Screw terminal: IP 20	Front: IP 40, Screw terminal: IP 20	Front: IP 40, Screw terminal: IP 20	Front: IP 40, Screw terminal: IP 20
Pollution degree	2 (IEC 60664-1, par. 4.6.2)		2 (IEC 60664-1, par. 4.6.2)	2 (IEC 60664-1, par. 4.6.2)
Operating temperature	-20°C to +50°C	-20°C to +50°C	-20°C to +50°C	-20°C to +50°C
Storage temperature	-30°C to +70°C	-30°C to +70°C	-50°C to +85°C	-50°C to +85°C
Humidity (non condensing)	90% @ 40°C	90% @ 40°C	20 to 80 %	20 to 80 %
Main features	Home automation master unit with datalogging capability. Linux based PC with 2 USB ports, ethernet port, 2 RS485 ports, local bus	Automatically creates BACnet/IP objects for all Dupline and energy meter data points. Ethernet port for BACnet/IP communication	Smart Dupline® bus generator. Connection of up to 250 slave modules	Dupline® bus generator
References				
	SH2WEB24	SB2WEB24	SH2MCG24	SH2DUG24

Dupline® Home and Building automation

	Bus generator		Network module	USB dongle connection module
Function	Wireless	DALI Master	Repeater	
				
Dimensions (mm)	2-DIN module	2-DIN module	2-DIN module	2-DIN module
Functions	Wireless base unit for generating wireless network	DALI Master and DALI Power supply	Repeater and isolator	Remote access by Internet when a wired connection is not available Plug 'n' play configuration SMS alerting SMS commands Email alertin
Electrical specifications				
Power supply	24 VDC, 115-240 VAC	230 VAC	230 VAC	12 to 28 VDC
General specifications				
LEDs	Green, yellow, blue	Green, yellow, yellow	Green, yellow, yellow	Green
Mounting	DIN-rail (2 modules)	DIN-rail (2 modules)	DIN-rail (2 modules)	DIN-rail (2 modules)
Degree of protection	Front: IP 40, Screw terminal: IP 20	Front: IP 40, Screw terminal: IP 20	Front: IP 40, Screw terminal: IP 20	Front: IP 40, Screw terminal: IP 20
Pollution degree	2 (IEC 60664-1, par. 4.6.2)	2 (IEC 60664-1, par. 4.6.2)	2 (IEC 60664-1, par. 4.6.2)	
Operating temperature	-20°C to +50°C	-20°C to +50°C	0°C to +50°C	-25°C to +65°C
Storage temperature	-50°C to +85°C	-40°C to +70°C	-50°C to +85°C	-30°C to +70°C
Humidity (non condensing)	20 to 80 %	20 to 80 %	20 to 90 %	
Main features	Wireless bus generator. Connection of up to 250 slave modules. Based on IEEE 802.15.4, @ 2.4 GHz Range up to 700 m	Acts as a gateway between Smart Dupline® and DALI. Enables the use of DALI lighting actuators in the system	Extends the transmission distance by regenerating the carrier signal and providing 300 mA bus output. Acts as an isolator between primary and secondary Dupline®	Compatible with Sx2WEB system Mobile Internet connection Compatible with USB dongle modems. Watchdog features to prevent common mobile network hassles
References				
	SH2WBU230N	SB2DALI230	SB2REP230	SH2DSP24

Dupline® Home and Building automation

Relay modules

Output type	SPST relay	Bistable relay	Bistable relay	Bistable relay
-------------	------------	----------------	----------------	----------------



Dimensions (mm)	2-DIN module	2-DIN module	2-DIN module	26 x 39 x 17
Functions	Four-relay output module	Four-relay output module	Two-relay output module with energy measurement	Small sized remote relay output

Electrical specifications

Outputs	4	4	2	1
Power supply	24 VDC	Bus	230 VAC	Bus

General specifications

LEDs	Green, yellow, red	Green, yellow, red	Green, yellow, red	
Mounting	DIN-rail (2 modules)	DIN-rail (2 modules)	DIN-rail (2 modules)	Decentralized
Degree of protection	Front: IP 40, Screw terminal: IP 20	Front: IP 40, Screw terminal: IP 20	Front: IP 40, Screw terminal: IP 20	
Pollution degree	2 (IEC 60664-1, par. 4.6.2)	2 (IEC 60664-1, par. 4.6.2)	2 (IEC 60664-1, par. 4.6.2)	3 (IEC 60664)
Operating temperature	-20°C to +50°C	-20°C to +50°C	-20°C to +50°C	-20°C to +50°C
Storage temperature	-50°C to +85°C	-50°C to +85°C	-50°C to +85°C	-50°C to +85°C
Humidity (non condensing)	20 to 80 %	20 to 80 %	20 to 80 %	20 to 80 %
Main features	Load: 5 A, voltage free x 4 Local bus	Load: 16 A, 230 VAC x 4 Local bus	Load: 16 A, 230 VAC x 2 Energy reading, Local bus	Load: 13 A, 250 VAC

References





SH2RE1A424

SH2RE16A4





SH2RE16A2E230

BDA-RE13A-U





Dupline® Home and Building automation

	Relay modules		Roller blind modules	
Output type	Bistable relay	SPST relay	SPST relay	SPST relay
				
Dimensions (mm)	40 x 45 x 31	50 x 50 x 30	2-DIN module	2-DIN module
Functions	Wireless relay output module with energy measurement	Decentralized module for up/down control of one rollerblind motor	Relay output module for up/down control of two AC rollerblind motors	Relay output module for up/down control of two DC rollerblind motors
Electrical specifications				
Outputs	1	1 SPST relay & 1 SPDT relay	2 SPST + 2 SPDT relay	2 SPST + 2 SPDT relay
Inputs		AC	AC	DC
Power supply	230/110 VAC	230 VAC ± 15%	24 VDC ± 20%	24 VDC ± 20%
General specifications				
LEDs	Green, blue		Green, yellow, red	Green, yellow, red
Mounting		Eurobox	DIN-rail (2 modules)	DIN-rail (2 modules)
Degree of protection			Front: IP 40, Screw terminal: IP 20	Front: IP 40, Screw terminal: IP 20
Pollution degree	2 (IEC 60664-1, par. 4.6.2)	3 (IEC 60664)	2 (IEC 60664-1, par. 4.6.2)	2 (IEC 60664-1, par. 4.6.2)
Operating temperature	-20°C to +50°C	-20°C to +50°C	-20°C to +50°C	-20°C to +50°C
Storage temperature	-50°C to +85°C	-50°C to +85°C	-50°C to +85°C	-50°C to +85°C
Humidity (non condensing)	20 to 80 %	20 to 80 %	20 to 80 %	20 to 80 %
Main features	Load: 10 A , 250 VAC Energy reading, Wireless	Up/down control, tilting, local bus	Up/down control, tilting, local bus	Up/down control, tilting, local bus
References				
		SHDRODC230	SH2ROAC224	SH2RODC224
115...230 VAC				
230 VAC	SHJWRE10AE230			
115 VAC	SHJWRE10AE115			
Capacitive push buttons	SHJWRE10AExLS230			

Dupline® Home and Building automation

Output type	Dimmer modules		Output modules	
	Power mosfet	Wireless dimmer	1 to 10 V output	Solid state relay
				
Dimensions (mm)	2-DIN module	40 x 45 x 31	2-DIN module	2-DIN module
Functions	Power dimmer up to 500 W for R, L, C load and LED lamps	Power dimmer up to 200 W for R, L, C load and LED lamps	Analogue output dimmer for adjustable ballast with 1 to 10 V input	Four-solid-state relay output module
Electrical specifications				
Outputs	1	1	4	4
Power supply	230 VAC	230/110 VAC	24 VDC ± 20%	24 VDC ± 20%
General specifications				
LEDs	Green, yellow, red	Green, blue	Green, yellow, red	Green, yellow, red
Mounting	DIN-rail (2 modules)		DIN-rail (2 modules)	DIN-rail (2 modules)
Degree of protection	Front: IP 40, Screw terminal: IP 20		Front: IP 40, Screw terminal: IP 20	Front: IP 40, Screw terminal: IP 20
Pollution degree	2 (IEC 60664-1, par. 4.6.2)	2 (IEC 60664-1, par. 4.6.2)	2 (IEC 60664-1, par. 4.6.2)	2 (IEC 60664-1, par. 4.6.2)
Operating temperature	-20°C to +50°C	-20°C to +50°C	-20°C to +50°C	-20°C to +50°C
Storage temperature	-50°C to +85°C	-50°C to +85°C	-50°C to +85°C	-50°C to +85°C
Humidity (non condensing)	20 to 80 %	20 to 80 %	20 to 80 %	20 to 80 %
Main features	Local bus / Energy reading	Wireless universal dimmer with energy reading		Load: 10 W x 4 Local bus
References				
With energy reading	SH2D500WE230			
Without energy reading	SH2D500W1230			
230 VAC	SHJWD200WE230			
115 VAC	SHJWD200WE115			
Capacitive push buttons	SHJWD200WE_xLS230			
			SH2D10V424	SH2SSTRI424

Dupline® Home and Building automation

	Energy meter modules		Digital input module	Fire Damper
Function	Dupline® connection	Wireless	4 inputs	I/O module
				

Dimensions (mm)	2-DIN module	40 x 45 x 31	2-DIN module	150x110x70
Functions	Energy meter with direct connection up to 16 A	Energy meter with direct connection up to 16 A	Input module, configurable as contact or pulse counter	I/O-module for control of two fire dampers

Electrical specifications

Inputs			4	4
Outputs				2
Motor type	1	1		
Power supply	115...240 VAC	115...240 VAC	24 VDC ± 20%	24...230 VAC





General specifications

LEDs	Green, yellow, red	Green, blue	Green, yellow, red	Green, yellow (3)
Mounting	DIN-rail (2 modules)		DIN-rail (2 modules)	Box ready for wall mounting
Degree of protection	Front: IP 40, Screw terminal: IP 20		Front: IP 40, Screw terminal: IP 20	IP50
Pollution degree	2 (IEC 60664-1, par. 4.6.2)	2 (IEC 60664-1, par. 4.6.2)	2 (IEC 60664-1, par. 4.6.2)	2 (IEC 60664-1, par. 4.6.2)
Operating temperature	-20°C to +50°C	-20°C to +50°C	-20°C to +50°C	0°C to +50°C
Storage temperature	-50°C to +85°C	-50°C to +85°C	-50°C to +85°C	-50°C to +85°C
Humidity (non condensing)	20 to 80 %	20 to 80 %	20 to 80 %	20 to 90 %
Main features	Values readout: A, V, W, Wdmd, VA, var, PF, kWh	Values readout: A, V, W, Wdmd, VA, var, PF, kWh	Voltage free, NPN, PNP, counter	Box ready for decentral mounting near dampers

References





			SH2INDI424	
115...230 VAC	SH2EM16A230			
230 VAC		SHJWEM16A230		SBB4I20230
115 VAC		SHJWEM16A115		
24 VAC				SBB4I2024

Dupline® Home and Building automation





	Transparent module	Analogue output modules	Analogue input modules	
Function		0 to 10 V output	Input module	Pulse counter
				
Dimensions (mm)	8.5 x 90 x 67	50 x 30 x 18	50 x 30 x 18	28 x 14 x 10
Functions	Transparent module for simplifying the wiring of the smart-house installation	Output module with 2 analogue outputs	Input module with 2 analogue inputs	Decentral 4 input pulse counter module
Electrical specifications				
Inputs	2 x 0-20 / 4-20 mA inputs			
Outputs	2 x 0-10 VDC			
Power supply	No power supply needed	24 VDC	24 VDC	Powered by bus
General specifications				
Mounting	DIN-rail	Inside wall box or environmental sensor housings	Inside wall box or environmental sensor housings	small sized plug-in
Degree of protection	Front: IP 40 Screw terminal: IP 20	IP 20	IP 20	IP 20
Pollution degree	2 (IEC 60664-1, par. 4.6.2)	2(IEC 60664-1, par. 4.6.2)	2 (IEC 60664-1, par. 4.6.2)	
Operating temperature	-20°C to +50°C	0°C to +50°C	0°C to +50°C	0°C to +50°C
Storage temperature	-30°C to +70°C	-50°C to +85°C	-50°C to +85°C	-50°C to +70°C
Humidity (non condensing)	20 to 80 %	20 to 90 %	20 to 90 %	20 to 90%
References				
	SH1DUPFT	SHPOUTV224	SHPINA224	
50 inputs				SHPINCTS04
Contact inputs				SHPINCNT4

Dupline® Home and Building automation

Analogue input modules

Function	Input module	Input module	Input module	Input module
				
Dimensions (mm)	50 x 30 x 18	50 x 30 x 18	50 x 30 x 18	50 x 30 x 18
Functions	Input module with 3 analogue inputs	Input module with 4 analogue inputs	Input module with 2 analogue inputs	Input module with 2 analogue inputs
Electrical specifications				
Inputs	3 x 0-10 VDC	2 x 0-10 VDC, 1 x thermistor 10K3 input 1 x variable resistor 1-11 KΩ	1 x thermistor 10K3 1 x variable resistor 1-11 KΩ	2* Ni1000/Pt1000 inputs
Power supply	24 VDC	24 VDC	Bus	Bus
General specifications				
Mounting	Inside wall box or environmental sensor housings	Inside wall box or environmental sensor housings	Inside wall box or environmental sensor housings	Inside wall box or environmental sensor housings
Degree of protection	IP 20	IP 20	IP 20	IP 20
Pollution degree	2 (IEC 60664-1, par. 4.6.2)	2 (IEC 60664-1, par. 4.6.2)	2 (IEC 60664-1, par. 4.6.2)	2 (IEC 60664-1, par. 4.6.2)
Operating temperature	0°C to +50°C	0°C to +50°C	0°C to +50°C	0°C to +50°C
Storage temperature	-50°C to +85°C	-50°C to +85°C	-50°C to +85°C	-50°C to +85°C
Humidity (non condensing)	20 to 90 %	20 to 90 %	20 to 90 %	20 to 90 %
References				
	SHPINV324	SHPINV2T1P124	SHPINT1P1	SHPINNI2

Dupline® Home and Building automation

Light Switch interfaces		Input modules		
Function	Input module	Input/output	Digital	Voltage
				
Dimensions (mm)	28 x 28 x 10	28 x 28 x 10	89 x 66 x 29	28 x 28 x 10
Functions	Input module for voltage free outputs	Input / output module for voltage free outputs and PNP transistor inputs	Input module for voltage free outputs or NPN transistor outputs.	Opto-isolated input voltage module, 90-265 VAC
Electrical specifications				
Inputs	4/8	4	4-contact or NPN transistor inputs	90 - 265 VAC
Outputs		4 PNP		
Power supply	Powered by bus	Powered by bus	Powered by bus	Powered by bus
General specifications				
LEDs			Green, yellow, red	
Mounting	In a junction box or behind a switch/pushbutton input	In a junction box or behind a switch/pushbutton input		
Degree of protection	IP 20	IP 20	IP 20	IP 20
Pollution degree				3 (IEC 60664)
Operating temperature	0°C to +50°C	0°C to +50°C	-20°C to +50°C	-20°C to +50°
Storage temperature	-20°C to +70°C	-20°C to +70°C	-50°C to +85°C	-50° to +70°C
Humidity (non condensing)	20 to 80%	20 to 80 %	20 to 80%	20 to 80%
References				
			BDD-INCON4-U	BDA-INVOL-U
4 contacts	BDB-INCON4-U			
8 contacts	BDB-INCON8-U			
Output voltage 3.3 V		BDB-IOCP8-U		
Output voltage 8 V		BDB-IOCP8A-U		

Dupline® Home and Building automation

Glass Switches



Function	Switch	Dimming	Temperature
Dimensions (mm)	120 x 80 x 27.2, 80 x 80 x 27.9	120 x 80 x 27.2, 80 x 80 x 27.9	120 x 80 x 27.2, 80 x 80 x 27.9
Functions	Programmable glass touch switch	Programmable glass touch switch for dimming control	Programmable glass touch switch for temperature control

Electrical specifications

Number of switches	4/6	4	4
Power supply	24 VDC	24 VDC	24 VDC

General specifications



Colour	Black/white	Black/white	Black/white
LEDs	Blue/white	Blue/white	Blue/white
Mounting	Ø60 box, 503 box	Ø60 box, 503 box	Ø60 box, 503 box
Degree of protection	IP 20	IP 20	IP 20
Pollution degree	3 (IEC 60664)	3 (IEC 60664)	3 (IEC 60664)
Operating temperature	-10°C to +50°C	-10°C to +50°C	-10°C to +50°C
Storage temperature	-20°C to +70°C	-20°C to +70°C	-20°C to +70°C
Humidity (non condensing)	20 to 80%	20 to 80%	20 to 80%
Remarks	Approved according to UL60950, integrated temperature probe	Approved according to UL60950	Approved according to UL60950, integrated temperature probe

References

4 push buttons, Ø60 box	SHG060WLS4, SHG060BLS4		
6 push buttons, 503 box	SHG503WLS6, SHG503BLS6		
Display for dimming, Ø60 box		SHG060WSLD, SHG060BSLD	
Display for dimming, 503 box		SHG503WSLD, SHG503SLD	
Temperature display, Ø60 box			SHG060WSLT, SHG060BSLT
Temperature display, 503 box			SHG503WSLT, SHG503BSLT

Dupline® Home and Building automation

Light Switches

Function	4 pushbutton	4 pushbutton	4 pushbutton + PIR + Luxmeter
			
Dimensions (mm)	44 x 44 / 55 x 55	44 x 44 / 55 x 55	44 x 44 / 55 x 55
Functions	Light switch for building automation applications	Wireless light switch for building automation applications	Light switch and PIR sensor for detecting presence and/or movement in indoor installations

Electrical specifications

Number of switches	4	4	4
Power supply	Powered by bus	Supplied by battery, type Lithium button 2450 3V	Powered by bus

General specifications



Colour	Black/white	Black/white	Black/white
LEDs	White/blue	Red/blue	White/blue
Mounting	Compatible with many types of wall boxes see datasheet	Compatible with many types of wall boxes see datasheet	Compatible with many types of wall boxes see datasheet
Degree of protection	IP 20	IP 20	IP 20
Pollution degree	3 (IEC 60664)	3 (IEC 60664)	3 (IEC 60664)
Operating temperature	-20°C to +50°C	-20°C to +50°C	0°C to +50°C
Storage temperature	-30°C to +60°C	-30°C to +60°C	-20°C to +70°C
Humidity (non condensing)	20 to 80%	20 to 80%	20 to 80%
Other functions	Humidity and temperature sensor (...TH)	55x55: Flat design, mountable on any surface, embedded temperature sensor	Operating distance: 8 m Angle: 90°
Remarks	Approved according to UL60950	Approved according to UL60950	Approved according to UL60950

References

44 x 44 Wallbox Btcino, Niko, Fuga	B4X-LS4-U	SHA4XWLS4	SHA4XLS4P90L
55 x 55 Compatible with many types of wall boxes - see datasheet	B5X-LS4-U	SHE5XWLS4WF SHE5XWLS4BF	SHE5XLS4P90L
55 x 55 Compatible with many types of wall boxes - see datasheet Temperature		SHE5XWLS4WFT SHE5XWLS4BFT	
44 x 44 Wallbox Btcino, Niko, Fuga Temperature and humidity	SHA4XLS4TH		
55 x 55 Compatible with many types of wall boxes - see datasheet Temperature and humidity	SHE5XLS4TH		

Dupline® Home and Building automation

Movement / Presence sensors

Function	Temperature display	150° PIR /Luxmeter	90° PIR/Luxmeter
			
Dimensions (mm)	44 x 44 / 55 x 55	44 x 44 / 55 x 55	44 x 44 / 55 x 55
Functions	Temperature controller with display	PIR sensor for detecting presence and/or movement in indoor installations	PIR sensor for detecting presence and/or movement in indoor installations

Electrical specifications



Number of switches	4		
Power supply	Powered by bus	Powered by bus	Powered by bus
General specifications			
Colour	White/black	White/black	White/black
LEDs	White/blue	White/blue	White/blue
Mounting	Wallbox Btcino, Niko, Fuga / Elko, Gira, Jung	Wallbox Btcino, Niko, Fuga / Elko, Gira, Jung	Wallbox Btcino, Niko, Fuga / Elko, Gira, Jung
Degree of protection	IP 20	IP 20	IP 20
Pollution degree	3 (IEC 60664)	3 (IEC 60664)	3 (IEC 60664)
Operating temperature	-10°C to +50°C	-20°C to +50°C	0°C to +50°C
Storage temperature	-20°C to +70°C	-30°C to +70°C	-20°C to +70°C
Humidity (non condensing)	20 to 80%	20 to 80%	20 to 80%
Remarks	Approved according to UL60950	Operating distance: 8 m angle: 150°	Operating distance: 8 m Angle: 90°

References

44 x 44 Wallbox Btcino, Niko, Fuga	SHA4XTEMDIS	SHA4XP150/SHA4XP150L	B4X-PIR90-U
55 x 55 Compatible with many types of wall boxes - see datasheet	SHE5XTEMDIS	SHE5XP150/SHE5XP150L	B5X-PIR90-U
44 x 44 Wallbox Btcino, Niko, Fuga + luxmeter			SHA4XP90L
55 x 55 Compatible with many types of wall boxes - see datasheet + luxmeter			SHE5XP90L

Dupline® Home and Building automation

Movement / Presence sensors

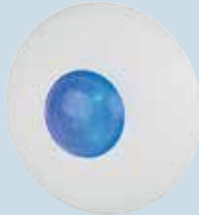
Function	90° PIR/ Luxmeter	90° PIR/ Luxmeter	90° PIR/ Luxmeter	360° PIR/ Luxmeter
				
Dimensions (mm)	104 x 55 x 57	Ø 76 x 25	67 x 52 x 34	Ø 90 x 40
Functions	PIR sensor for detecting presence and/or movement in indoor installations	PIR sensor for detecting presence and/or movement in indoor installations	PIR sensor for detecting presence and/or movement in indoor /outdoor installations	PIR sensor for detecting presence and/or movement in indoor installations with a built-in luxmeter

Electrical specifications

Power supply	Powered by bus	Powered by bus	Powered by bus	Powered by bus
--------------	----------------	----------------	----------------	----------------

General specifications

Colour	White	White	White	White
LEDs	Red	Blue	Red	Blue
Mounting	Wall mounting	LK ceilingbox PL52 or PL55	Wall mounting	Ceiling mounting
Degree of protection	IP 40	IP 20	IP 64 / IP 20	IP 20
Pollution degree	3 (IEC 60664)	3 (IEC 60664)	3 (IEC 60664)	3 (IEC 60664)
Operating temperature	0°C to +50°C	0°C to +50°C	-20°C to +50°C	0°C to +50°C
Storage temperature	-20°C to +70°C	-20°C to +70°C	-30°C to +70°C	-20°C to +70°C
Humidity (non condensing)	20 to 80%	20 to 80%	20 to 80%	20 to 80%
Main features	Operating distance: 12 m Angle: 90°	Operating distance: ≤ 8 m Angle: 90°	Operating distance: 0.5 - 15 m Angle: 90°	Operating distance: ≤ 7.5 m Angle: 360° Lens: dual detecting zones





References

	BSD-PIR90-U	BSB-PIR90-U	SHSQP360L
Luxmeter	SHSDP90L	SHSBP90L	
Outdoor			BSP-PIR90-U
Indoor			BSP-PIR90A-U
Outdoor + luxmeter			SHSPP90L
Indoor + luxmeter			SHSPP90LA

Dupline® Home and Building automation

Touch displays

Environmental sensors

Function	Graphical display	Display	RGB LED	Blind
				
				
Dimensions (mm)	187 x 147 / 147 x 107	80 x 90 x 26	80 x 90 x 26	80 x 90 x 26
Functions	High definition 7" and 4.3" colour touchscreens, BACnet, Modbus and KNX gateway	Room sensors for CO ₂ , temperature and %RH measurement - with display	Room sensors for CO ₂ , temperature and %RH measurement - with LED indication	Room sensors for CO ₂ , temperature and %RH measurement

Electrical specifications

Power supply	24 VDC ± 20%	Bus	Bus	Bus
--------------	--------------	-----	-----	-----





General specifications

Mounting	Wall mounting	Wall mounting	Wall mounting	Wall mounting
Indication	Display	Display	Red, green, blue	None
Degree of protection	Front: IP66 Rear: IP20	IP 20	IP 20	IP 20
Pollution degree		2 (IEC 60664-1, par. 4.6.2)	2 (IEC 60664-1, par. 4.6.2)	2 (IEC 60664-1, par. 4.6.2)
Operating temperature	0°C to +50°C	-20°C to +50°C	-20°C to +50°C	-20°C to +50°C
Storage temperature	-20°C to +70°C	-40°C to +70°C	-40°C to +70°C	-40°C to +70°C
Humidity (non condensing)	5 to 85% RH	0 to 90 %	0 to 90 %	0 to 90 %
Main features	Windows CE, 7", 800 x 480 pixel / 4.3", 480 x 272 pixel, Ethernet port, BACnet, Modbus, KNX, data logging, configurable graphical display and alarms management	CO ₂ measuring range: 0 to 2000 ppm CO ₂ measurement: Dual source infrared NDIR technology Temperature measuring range: -20°C to +50°C (-4 to 122°F) Humidity measuring range: 0 to 100 %RH	CO ₂ measuring range: 0 to 2000 ppm CO ₂ measurement: Dual source infrared NDIR technology Temperature measuring range: -20°C to +50°C (-4 to 122°F) Humidity measuring range: 0 to 100 %RH	CO ₂ measuring range: 0 to 2000 ppm CO ₂ measurement: Dual source infrared NDIR technology Temperature measuring range: -20°C to +50°C (-4 to 122°F) Humidity measuring range: 0 to 100 %RH





References

7", 800 x 480 pixel	BTM-T7-24			
4.3", 480 x 272 pixel	BTM-T4-24			
Display, CO ₂ + temperature		SHSUCOTD		
Display, CO ₂ + temperature + humidity		SHSUCOTH		
Display, temperature + humidity		SHSUTH		
Display, temperature		SHSUTD		
RGB Led, CO ₂ + temperature			SHSUCOTL	
RGB Led, temperature + humidity			SHSUCOHL	
CO ₂ + temperature				SHSUCOT
CO ₂ + temperature + humidity				SHSUCOTH
Temperature + humidity				SHSUTH
Temperature				SHSUT



Dupline® Home and Building automation

	Smoke	Water	Window	Alarm
Function	Smoke detector	Water sensor	Wireless sensor	Keypad
				
Dimensions (mm)	Ø 100 x 54	70 x 39 x 15.5	sensor: 60 x 30 x 15.5, magnet: 32 x 10.2 x 11.5	130 x 50 x 8
Functions	Smoke detector for home/ building applications	Water detection sensor for home/building applications	Wireless, battery powered reed sensor with additional input	Programmable keypad for building access control and alarm control in indoor and outdoor applications
Electrical specifications				
Inputs			Reed, voltage free	12 pushbuttons
Power supply	Powered by bus / 9 VDC battery	Powered by bus	Battery	9-17 VDC
General specifications				
Colour	White	White	White	Black / white
LEDs	Red		Red/blue	Yellow, red, green, programmable
Mounting	Ceiling mounting	Wall mounting	Wall mounting, screw and double side tape	Wall box mounting
Degree of protection	IP 43	IP 67	IP20	IP 67
Pollution degree			2 (IEC 60664-1, par. 4.6.2)	
Operating temperature	0°C to +50°C	-20°C to +50°C	-20°C to +50°C	-15°C to +60°C
Storage temperature	-5°C to +85°C	-50°C to +85°C	-30°C to +85°C	-30° to 80°C
Humidity (non condensing)	20 to 80%	20 to 80 %	20 to 80 %	100%
Main features	Detection area: 60 m ²	Input for Felson probe		28 user-programmable codes, Buzzer output
References				
		BSF-WAT-U		BACC-KEYPAD-DC-U
Battery backup	BSG-SMOA-U			
No battery backup	BSG-SMO-U			
Reed contact			SHDWWISEN	
Reed contact + voltage free			SHDWWISENIN1	



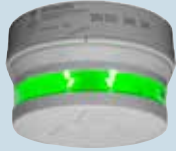

Dupline® Home and Building automation

	Enviromental sensor		Light	Temperature
Function	Weather station	Anemometer	Luxmeter	Outdoor
				
Dimensions (mm)	96 x 77 x 118	183 x 137 x 145	55 x 53 x 36	67 x 35 x 15
Functions	Weather station for measurement of temperature, wind speed, brightness and precipitation	Anemometer for building automation applications	Luxmeter for indoor / outdoor installations	Temperature sensor for indoor and outdoor applications
Electrical specifications				
Power supply	12 to 40 VDC / 12 to 28 VAC	Powered by bus	Powered by bus	Powered by bus
General specifications				
Colour	White		White	Light grey
Mounting	Wall mounting	Wall mounting	Wall mounting	Direct wall mounting
Connection				Cable / plug
Degree of protection	IP 44	IP 54	IP 44	IP 67
Pollution degree		2 (IEC 60664-1, par. 4.6.2)		
Operating temperature	-30°C to +50°	-20°C to +60°C	-30°C to +60°C	-40°C to +60°C
Storage temperature	-30°C to +70°C	-20°C to +60°C		-55°C to +85°C
Humidity (non condensing)	5 to 95%	20 to 80%		20 to 80%
Main features	GPS receiver	Measuring range: 2 to 25 m/s Heating system	Measuring range: 0 to 20 kLux	
Remarks				Approved according to UL60950
References				
	SHOWEAGPS	BSN-ANE-U	BSH-LUX-U	
Cable, 2 m				BSI-TEMANAB-U
Plug, M12				BSI-TEMANA-U



Dupline® Parking guidance system

	Sensor	Led indicator	Baseholder
Types	SBPSUSLxx	SBPILED	SBPBASEx
			
Dimensions (mm)	Ø116 x 78	Ø116 x 50	Ø116 x 26 / Ø116 x 44
Functions	Ultrasonic sensors for detection of cars and with RGB LED indication	LED indicator with RGB LED indication	Baseholder for Carpark sensors and LED indicator
Housing type	Direct mounting on base holder to rail, ceiling or conduit/pipe	Direct mounting on base holder to rail, ceiling or conduit/pipe	Direct mounting of base holder on rail, ceiling or conduit/pipe
Electrical specifications			
Features/Signal types	3-wire sensor with built-in RGB LEDs. Programmable from the SBP2WEB configuration software. Can detect available or occupied spaces or be used in count systems	3-wire LED indicator with built-in RGB LEDs. Programmable from the SBP2WEB24 configuration software. To be mounted outside the parking space	Baseholder for sensors and LED indicators. No programming. Only wire connected
Power supply	3-wire system with Dupline® and sensor supply	3-wire system with Dupline® and sensor supply	
General specifications			
Degree of protection	IP 34	IP 34	IP 34
Operating temperature	-40°C to +70°C	-40°C to +70°C	-40°C to +70°C
Storage temperature	-40°C to +85°C	-50°C to +85°C	-50°C to +85°C
References			
45 degree sensor	SBPSUSL45		
Vertical sensor	SBPSUSL		
Counting sensor	SBPSUSCNT		
LED indicator		SBPILED	
Baseholder for cable tray / conduit			SBPBASEA
Baseholder for ceiling			SBPBASEB

Dupline® Parking guidance system

	Carpark Master generator	Carpark Controller	Carpark Server	Carpark Display interface
Types	SBP2MCG324	SBP2WEB24	SBP2CPY24	SBP2DI48524
				
Dimensions	2-DIN module	2-DIN module	2-DIN module	2-DIN module
Functions	The Carpark Master Generator provide 28 VDC power and bus on a 3-wire connection with up to 90 sensors	Programmable controller with functions for parking guidance, booking, energy saving. One controller can manage up to 7 Dupline® networks (630 spaces).	Carpark server to link together up to 10 carpark controllers SBP2WEB24 in a TCP/IP network to manage large networks (up to 6300 spaces).	Module that interface between Dupline and Modbus RTU for Carpark displays
Housing type	Mounting on DIN rail	Mounting on DIN rail	Mounting on DIN rail	Mounting on DIN-rail
Electrical specifications				
Features/Signal types	3-wire master generator for carpark sensors and LED indicators. Other smartbuilding components such as PIR, CO sensors and HVAC modules can be connected to the same bus	Various I/O's and function parameters are available as BACnet/IP objects through the Ethernet port, thereby allowing seamless integration with any building management system, thereby allowing energy saving functions for lighting and ventilation	The webserver aggregates data from multiple carpark controllers in a single centralized database, allowing the user to access them as a graphical user interface through a PC with a standard Web-browser	Interface module between Dupline® and Modbus RTU. RS485 to display. Up to 300 m.
Power supply	28 VDC	24 VDC	24 VDC	24 VDC
General specifications				
Degree of protection	IP 20	IP 20	IP 20	IP20
Pollution degree	-20°C to +50°C	-25°C to +50°C	-25°C to +50°C	-20°C to +50°C
Operating temperature	-50°C to +85°C	-30°C to +70°C	-30°C to +70°C	-50°C to +85°C
References				
Carpark master generator	SBP2MCG324			
Carpark controller		SBP2WEB24		
Carpark server			SBP2CPY24	
Display interface				SBP2DI48524

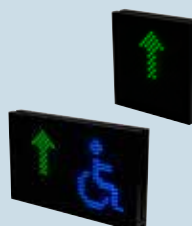
Dupline® Parking guidance system

				Displays			
Types	SBPDISxxxxT	SBPDISxT	SBPDIS9x				
							
Dimensions (mm)	215 x 215 x 45 215 x 535 x 45 215 x 358 x 45 215 x 428 x 45 215 x 464 x 45	215 x 253 x 45 215 x 360 x 45 215 x 467 x 45	215 x 950 x 45				
Functions	Displays with: green arrow or red cross, disabled sign and up to 3 clear white digits. Programmable from Carpark software	Displays with: 2 - 4 clear white digits. Programmable from Carpark software	9 character matrix display with clear white LED. Can combine text and digits. Programmable from Carpark software				
Housing type	Black aluminium box with acrylic glass front	Black aluminium box with acrylic glass front	Black aluminium box with acrylic glass front				
Electrical specifications							
Power supply	24 VDC / 5-25 W (40- 60 W heated version)	24 VDC / 14-30 W (50-65 W heated version)	24 VDC / 62 W (120 W heated version)				
Features							
	Guides the driver by showing moving green arrow or red cross as well as number of free spaces for a lane or area in the carpark. Blue sign for disabled can be added. RS485 communication	Guides the driver by showing number of free spaces for a lane or area in the carpark by the use of clear white digits. RS485 communication	Show a text or a combination with up to 4 digits on max. 9 character. The text is of costumers own choice. RS485 communication				
General specifications							
Degree of protection	IP 54	IP 54	IP 54				
Pollution degree	3 (IEC 60664)	3 (IEC 60664)	3 (IEC 60664)				
Operating temperature	-20°C to +50°C -40°C to + 50°C (heated version)	-20°C to +50°C -40°C to + 50°C (heated version)	-20°C to +50°C -40°C to + 50°C (heated version)				
Humidity	5 to 90% non condensing	5 to 90% non condensing	5 to 90% non condensing				
References							
Arrow	SBPDISA (T)						
Arrow / disabled	SBPDISARH (T) / SBPDISALH (T)						
Arrow / disabled / 1 digit	SBPDIS1ARH (T) / SBPDIS1ALH (T)						
Arrow / 2 digit	SBPDIS2AR (T) / SBPDIS2AL (T)						
Arrow / 3 digit	SBPDIS3AR (T) / SBPDIS3AL (T)						
2 digit	SBPDIS2 (T)						
3 digit	SBPDIS3 (T)						
4 digit	SBPDIS4 (T)						
9 digit	SBPDIS9 (T)						

Dupline® DuplineSafe

	Input module	Output module	Gateway / interface	
Types	GS7510 2101	GS3830 0143	GS3891 0125	GSTI 50
				

Dimensions (mm)	57.5 x 36.0 x 16.4	144 x 77 x 70	144 x 77 x 70	55 x 70 x 15
Functions	Bus-powered safety input module	DuplineSafe relay output module. Monitors up to 63 DuplineSafe inputs	Profibus-DP Gateway passive with Safety mapping	Dupline® Modbus interface module with Safety mapping
Housing type		DIN-rail mounting H8	DIN-rail mounting H8	Compact plastic housing

Electrical specifications

Number of channels	2	2		
Features/Signal types	1 x NC contact	2 x NO Relays Force Guided contact	Reads/controls up to 128 inputs/outputs through Profibus-DP, Communication speed up to 12 Mbaud	
Power supply	Powered through the Dupline® network	230 VAC ± 15%	115 = 115 VAC 230 = 230 VAC	Powered by the RS485 com port





General specifications

Degree of protection	IP 67	IP 20	IP 20	IP 20
Pollution degree	3 (IEC 60664)	3 (IEC 60664)		
Operating temperature	-40°C to +50°C	-25°C to +50°C	0°C to +50°C	-20°C to +60°C
Storage temperature	-40°C to +70°C	-30°C to +70°C	-20°C to +85°C	-30°C to +85°C
Humidity (non condensing)	20 to 80%	20 to 80%	20 to 80%	
Remarks	Approved according to IEC/EN 61508, EN 62061 and ISO/EN 13849-1 PL e	Approved according to IEC/EN 61508, EN 62061 and ISO/EN 13849-1 PL e	Certified by PNO	Supports Modbus RTU function code 3 and code 16

References



Cable connection	GS7510 2101			
Cable connection cULus approved	GS7510 2192			
Plug connector	GS7510 2101-1			
Plug connector cULus approved	GS7510 2192-1			
Output relay		GS3830 0143		
Gateway / interface			GS3891 0125	GSTI 50

Dupline® DuplineSafe





	Optical fibre converter	Repeater	Configuration tool	
Types	GS3492/GS3493	GS3892 0000	GS7380 0080	GS7380 0081
				
Dimensions (mm)	77 x 72 x 70	77 x 144 x 70	28 x 90 x 145	25 x 50 x 100
Functions	Optical repeater for converting DuplineSafe from electrical to optical transmission media	DuplineSafe signal repeater for extension of transmission distance	Configuration and test unit for DuplineSafe	USB Configuration unit for DuplineSafe
Housing type	DIN-Rail, H4	DIN-Rail H8	Handheld	Handheld
Electrical specifications				
Number of channels	Adjusts automatically	Adjusts automatically		
Features/Signal types	All Dupline® signal types	Regenerates the Dupline® signal carrier through channel generator output		Windows based programming tool for safety output relay module and safety input modules
Power supply	230 = 115/230 VAC	024 = 024 VAC 115 = 115 VAC 230 = 230 VAC	9 V battery 6LR61	Supplied by the USB port
General specifications				
Degree of protection	IP 20	IP 40	IP 40	IP 40
Pollution degree				3 (IEC 60664)
Operating temperature	0°C to +50°C	0°C to +50°C	-10°C to +45°C	0°C to +50°C
Storage temperature	-20°C to +85°C	-50°C to +85°C	-20°C to +70°C	-20°C to +60°C
Humidity (non condensing)				
Remarks	Operates pair-wise. Runs on 50/125, 62.5/125 or 100/140 micro m with STN connectors		Adapt 7380 is included	
References				
		GS3892 0000	GS7380 0080	GS7380 0081
Optical/electrical converter	GS3492 0000			
Electrical/optical converter	GS3493 0000			

Dupline® Industrial

Channel generators/interfaces





Types	G3490	G3496	G3800
			
Dimensions (mm)	77 x 72 x 70	77 x 72 x 70	77 x 144 x 70
Functions	Standard channel generator	Plug & Play RS232/RS485 Interface with built-in protocols for specific PLC brands and Modbus	Controller and Modbus Interface with built-in GSM Modem (option) or external Radio Modem Logger (option)
Housing type	DIN-Rail, H4	DIN-Rail, H4	DIN-Rail, H8
Electrical specifications			
Number of channels	Selectable	Selectable	Selectable
Features/Signal types		Possibility for 3-wire operation with DC-power on the 3 rd wire	4 x Contact/PNP input +4 x PNP 10-30 VDC output 2 x RS232+1 x RS485. Possibility for alarms, monitoring and control via SMS messages
Power supply	024 = 24 VAC 115 = 115 VAC 230 = 230 VAC 824 = 15-30 VDC	700 = 20-30 VDC	800 = 10-30 VDC 230 = 115-230 VAC
General specifications			
Degree of protection	IP 20	IP 20	IP 20
Operating temperature	-20°C to +50°C	0°C to +50°C	0°C to +50°C
Storage temperature	-50°C to +85°C	-50°C to +85°C	-20°C to +85°C
Remarks		Built-in protocol for specific PLC brands for easy interfacing	Up to 32 controllers can be networked together via RS485 or Ethernet via converter module
References			
Channel Generator	G3490 0000		
Optolink	G3496 0000		
LG	G3496 0001		
GE-Fanuc	G3496 0002		
Mitsubishi	G3496 0003		
Omron	G3496 0004		
Modbus	G3496 0005		
Allen-Bradley	G3496 0006		
Schneider	G3496 0007		
Koyo	G3496 0008		
Matsushita	G3496 0009		
Siemens	G3496 0010		
Toshiba	G3496 0011		
IDEC	G3496 0012		
-GSM Modem, -RS485			G3800 0015
+GSM Modem, -RS485			G3800 1015
-GSM Modem, +RS485			G3800 0016
+GSM Modem, +RS485			G3800 1016
-GSM Modem, +RS485, +Logging			G3800 0036
+GSM Modem, +RS485, +Logging			G3800 1036

Dupline® Industrial





	Channel generators/interfaces		Digital input modules	
Types	G3891	GTI50	G3410 5501	G3420
				
Dimensions (mm)	77 x 144 x 70	55 x 70 x 15 mm	77 x 72 x 70	77 x 72 x 70
Functions	Gateways to Fieldbus systems (Profibus-DP, DeviceNet etc.)	Dupline® Modbus RTU Interface module for Text Displays and Touch screens	Dupline® powered transmitter with 8 monostable volt-free contacts	Input module for external supply with optoisolated inputs
Housing type	DIN-Rail, H8	Closed plastic housing with 25p male sub-D	DIN-Rail, H4	DIN-Rail, H4
Electrical specifications				
Number of channels	Selectable		8	8
Features/Signal types		Supports Modbus RTU function code 3 and code 16	Volt-free input contacts	Contact/NPN Voltage (6-265 VAC/DC)
Power supply	230 = 115/230 VAC	Powered by RS485 port	Powered by Dupline®	024 = 24 VAC 115 = 115 VAC 230 = 230 VAC 800 = 10-30 VDC
General specifications				
Degree of protection	IP 20	IP 20	IP 20	IP 20
Operating temperature	0°C to +50°C	-20°C to +60°C	-20°C to +50°C	-20°C to +50°C
Storage temperature	-20°C to +85°C	-50°C to +85°C	-50°C to +85°C	-50°C to +85°C
Remarks	Low power consumption			
References				
GTI50				
Profibus-DP with C. G.	G3891 0020			
Profibus-DP analogue output multiplex	G3891 0021			
DeviceNet	G3891 0050			
Lonworks	G3891 0051			
Modbus / TCP	G3891 0052			
Profibus-DP passive	G3891 0120			
8 channel	G3410 5501			
Contact/NPN				G3420 5501
Voltage				G3420 5502

Dupline® Industrial





Digital input modules

Types	G4420 7401	G5010	G6391 0240	G8810 2201
				
Dimensions (mm)	36 x 85 x 58	49 x 22.5 x 56	34.2 x 37.5 x 36.8	28 x 14 x 10
Functions	Input module for counting of pulses from energy meters, item detectors etc	Dupline powered single input Module	Plug-in module to EM4 or WM22 with 2 SO input contacts for measuring water, gas etc	Small-sized 2-channel monostable transmitter
Housing type	DIN-Rail, H2	DIN-Rail, Mini-E	Plug-in	Plug-in
Electrical specifications				
Number of channels	4	1	2	2
Features/Signal types	Contact input (DIN 43 864). Max. count frequency: 14 Hz	Contact input	Reads actual internal value of total energy and/or reactive energy from EM4/WM22 and transmits to Dupline®. 2 x SO contact input	2 contact inputs for push buttons
Power supply	230 = 230 VAC 724 = 15-30 VDC	Powered through the Dupline® network	Powered through the Dupline® network and EM4/WM22	Supplied by Dupline®
General specifications				
Degree of protection	IP 40	IP 20	IP 20	IP 65
Operating temperature	-20°C to +60°C	-20°C to +50°C	0°C to +50°C	-40°C to +70°C
Storage temperature	-20°C to +85°C	-50°C to +85°C	-20°C to +85°C	-40°C to +70°C
Remarks	Decentral counting. Counter values stored in non-volatile memory			Address coding by GAP 1605
References				
4 channel Counter	G4420 7401			
1 channel		G5010 1106		
2 channels		G5010 2206		G8810 2201
2 channel plug-in module			G6391 0240	



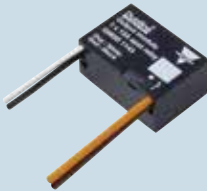

Dupline® Industrial

	Digital I/O modules		Digital output modules	
Types	G3440 4443	G3440 5543	G3430 / G3830	G34305545
				
Dimensions (mm)	77 x 72 x 70	77 x 72 x 70	77 x 72 x 70 77 x 144 x 70 (H8)	77 x 72 x 70
Functions	Combined I/O module for external supply with optoisolated inputs and relay outputs	I/O module for digital signals	Output modules for external supply with isolated outputs	Central relay module with 8 x SPST relays for resistive loads
Housing type	DIN-Rail, H4	DIN-Rail, H4	DIN-Rail, H4 DIN-Rail, H8 (G3830 5543)	DIN-Rail, H4
Electrical specifications				
Number of channels	4	6	1, 2, 4, 8	8
Features/Signal types	2 x 6-265 VAC/DC inputs + 2 x SPST relay outputs	4 opto isolated inputs and 2 SPST relay outputs	10 A SPDT relay 5 A SPST relay 0.7 A NPN transistor 0.7 A PNP transistor	8 x 16 A/250 VAC relays Inrush current: <130 A
Power supply	024 = 24 VAC 115 = 115 VAC 230 = 230 VAC 824 = 15-30 VDC	230 = 230 VAC	024 = 24 VAC 115 = 115 VAC 230 = 230 VAC 800 = 10-30 VDC 824 = 15-30 VDC	024 = 24 VAC 115 = 115 VAC 230 = 230 VAC
General specifications				
Degree of protection	IP 20	IP 20	IP 20	IP 20
Operating temperature	-20°C to +50°C	-20°C to +50°C	-20°C to +50°C	-5°C to +50°C
Storage temperature	-50°C to +85°C	-50°C to +85°C	-50°C to +85°C	-50°C to +85°C
Remarks				Total module load max. 32 A
References				
2 input + 2 output SPST	G3440 4443			
4 input + 2 output SPST		G3440 5543		
1 x 10 A SPDT			G3430 1149	
2 x 10 A SPDT			G3430 2249	
4 x 5 A SPST			G3430 4443	
4 x 16 A SPST			G3430 4445	
8 x 5 A SPST			G3830 5543	
8 x 0.7 A NPN			G3430 5511	
8 x 0.7 A PNP			G3430 5521	
8 x 16 A SPST (Max. 32 A)				G3430 5545



Dupline® Industrial

	Digital output modules		Analogue input modules	
Types	G8830 1143	G3429 6470	G3210 1161	G3210 1111
				
Dimensions (mm)	26 x 39 x 17	77 x 72 x 70	77 x 36 x 70	77 x 36 x 70
Functions	Decentral relay module with 1 x SPST relay for control of lights	Universal analogue input module for external supply	Analogue input module powered from Dupline® and input signal	Dupline®- powered Analogue input module for Pt100 temperature sensor
Housing type	Compact regular, with solid cables. For decentral installation	DIN-Rail, H4	DIN-Rail, H2	DIN-Rail, H2
Electrical specifications				
Number of channels	1	Selectable	1	1
Features/Signal types	1 x 13 A/250 VAC relay Inrush current: <130 A	4 x isolated analogue input. Input type individually configurable (0-20 mA, 4-20 mA, 0-10 VDC)	1 x 4-20 mA input	1 x Pt100 3-wire input Ranges: (-50°C to +40°C) (+30°C to +120°C) (-10°C to +100°C)
Power supply	Powered through the Dupline® network	024 = 24 VAC 115 = 115 VAC 230 = 230 VAC 800 = 10-30 VDC	Powered through the Dupline® network and 4-20 mA input signal	Powered through the Dupline® network
General specifications				
Degree of protection	IP 20	IP 20	IP 20	IP 20
Operating temperature	0°C to +50°C	0°C to +50°C	0°C to +50°C	0°C to +50°C
Storage temperature	-50°C to +85°C	-20°C to +85°C	-50°C to +85°C	-50°C to +85°C
Remarks	Recommended minimum load 100 mA / 12 V	Protocol freely selectable (Analink, Multiplexed BCD or 8-bit)	Uses Analink 8-bit protocol	Uses Analink 8-bit protocol. Built-in cable compensation
References				
Universal analogue output	G3429 6470			
Dupline powered analogue input	G3210 1161			
-50°C to +40°C	G3210 1111			
+30°C to +120°C	G3210 1112			
-10°C to +100°C	G3210 1113			
1 x 13 A SPST	G8830 1143			

Dupline® Industrial

	Analogue output modules	Decentral analogue input modules		
Types	G3439 6470	G8810 6265	G8810 6311	G8810 6312
				
Dimensions (mm)	77 x 72 x 70	50 X 30 X 18	50 X 30 X 18	50 X 30 X 18
Functions	Universal analogue output module for external supply	Decentral analogue module with 3 x 0-10 VDC inputs designed for HVAC systems	Decentral analogue module with 2 x 0-10 VDC, 1 x thermistor and 1 x variable resistor inputs designed for HVAC systems	Decentral analogue module with 1 x thermistor and 1 x variable resistor inputs designed for HVAC systems
Housing type	DIN-Rail, H4	Compact housing for decentral installation	Compact housing for decentral installation	Compact housing for decentral installation
Electrical specifications				
Number of channels	Selectable	3	4	2
Features/Signal types	4 x analogue outputs. Output type configurable for 0-20 mA, 4-20 mA or 0-10 VDC	3 x 0-10 VDC input	2 x 0-10 VDC input 1 x thermistor 10k3 input 1 x variable resistor 1 - 11 KΩ input	1 x thermistor 10k3 input 1 x variable resistor 1 - 11 KΩ input
Power supply	024 = 24 VAC 115 = 115 VAC 230 = 230 VAC 800 = 10-30 VDC	Powered from external 15 - 30 VDC	Powered from external 15 - 30 VDC	Dupline® powered
General specifications				
Degree of protection	IP 20	IP 20	IP 20	IP 20
Operating temperature	0°C to +50°C	0°C to +50°C	0°C to +50°C	0°C to +50°C
Storage temperature	-20°C to +85°C	-20°C to +85°C	-20°C to +85°C	-20°C to +85°C
Remarks	Protocol freely selectable (Analink, Multiplexed BCD or 8-bit)	Analink protocol 8 bit resolution	Analink protocol 8 bit resolution	Analink protocol 8 bit resolution
References				
Universal analogue output	G3439 6470			
Decentral 3 x input		G8810 6265		
Decentral 4 x input			G8810 6311	
Decentral 2 x input Bus powered				G8810 6312

Dupline® Industrial

	Digital sensors		Temperature sensor
Types	G6110 1145	G8910 1101	G8911 1010
			
Dimensions (mm)	M18 x 55	Ø11 x 68	67 x 35 x 15
Functions	Dupline® powered inductive proximity switch	Dupline® powered magnet proximity switch	Temperature sensor for outdoor use. With built-in PT1000 transducer
Housing type	M18	Cylindrical	Flat pack sensor housing
Electrical specifications			
Number of channels	1	1	1
Features/Signal types	Detects proximity of metal objects	Detects proximity of magnet	1 x Analink Range: -30°C to +60°C
Power supply	Powered through the Dupline® network	Powered through the Dupline® network	Powered through the Dupline® network
General specifications			
Degree of protection	IP 67	IP 67	IP 67
Operating temperature	-25°C to +70°C	-20°C to +50°C	-25°C to +70°C
Storage temperature	-30°C to +80°C	-20°C to +70°C	-55°C to +85°C
Remarks	Available with cable or M12 connector. Flush mounting	Available in Ø 11 plastic housing or with M14 metal thread	8-bit resolution
References			
Cable	G6110 1145		
M12 plug	G6110 1145-1		G8911 1010
Ø11		G8910 1101	
M14		G8910 1101-G	

Dupline® Industrial

Types	Repeater		Optolink interface	
Housing	D3892 0000	G3491 0000	G3491 0090	
				
Dimensions (mm)	77 x 144 x 70	77 x 72 x 70	77 x 72 x 70	
Functions	Dupline® signal Repeater for extension of transmission distance	RS232 to fibre optic interface	RS232 to fibre opto-link interface	
Housing type	DIN-Rail, H8	DIN-Rail, H4	DIN-Rail, H4	
Electrical specifications				
Number of channels	Adjusts automatically	Adjusts automatically	Adjusts automatically	
Features/Signal types	All Dupline® signal types. Regenerates the Dupline® signal carrier through channel-generator output	Reads/controls up to 63 Dupline® systems which are networked through optolinks (G3491 0000)	Used as interface between computer or PLC with RS232 and a fibre optic Lan-ring	
Power supply	024 = 24 VAC 115 = 115 VAC 230 = 230 VAC	024 = 24 VAC 115 = 115 VAC 230 = 230 VAC	024 = 24 VAC 115 = 115 VAC 230 = 230 VAC	
General specifications				
Degree of protection	IP 20	IP 20	IP 20	
Operating temperature	0°C to +50°C	0°C to +50°C	0°C to +50°C	
Storage temperature	-50°C to +85°C	-50°C to +85°C	-20°C to +85°C	
Remarks		Operates with G3491 0090	Operates with G3491 0000	
References				
Repeater (Booster)	D3892 0000			
Dupline® fibre interface	G3491 0000			
RS232 to optolink interface	G3491 0090			

Dupline® Industrial

	Converters		Display modules	Power supply
Types	G3491 0040	G3492 / G3493	G5460 6606	G3485 0000



Dimensions (mm)	77 x 72 x 70	77 x 72 x 70	96 x 96 x 78	77 x 72 x 70
Functions	Private line Modem for long distance transmission of Dupline® signals	Optical repeater for converting Dupline® from electrical to optical transmission media	LED status indicator for 16 Dupline® channels	3-wire power supply, used when multiple Dupline® modules are supplied through a DCbus
Housing type	DIN-Rail, H4	DIN-Rail, H4	Panel mounting	DIN-Rail, H4

Electrical specifications

Number of channels	Adjusts automatically	Adjusts automatically	16	Selectable
Features/Signal types	Digital, 8-bit analogue, non-multiplexed 3 1/2 digit BCD analogue	All Dupline® signal types	Each of the 16 LED's indicates the status of the digital channels assigned to it	Supply current ≤ 4 A (up to 25°C) or ≥ 3 A (up to 50°C)
Power supply	024 = 24 VAC 115 = 115 VAC 230 = 230 VAC	230 = 115/230 VAC	024 = 24 VAC 115 = 115 VAC 230 = 230 VAC	15-30 VDC



General specifications

Degree of protection	IP 20	IP 20	IP 40	IP 20
Operating temperature	0°C to +50°C	0°C to +50°C	0°C to +50°C	-5°C to +50°C
Storage temperature	-20°C to +85°C	-20°C to +85°C	-20°C to +60°C	-20°C to +85°C
Remarks	Operates pair-wise	Operates pair-wise. Runs on 0/125, 62.5/125 or 100/140 micro m with STN connectors		Multiple units can be connected in parallel to increase length and size of a Dupline® system

References



Long distance modem	G3491 0040			
Optical/electrical converter		G3492 0000		
Electrical/optical converter		G3493 0000		
LED indicator for Dupline			G5460 6606	
3-wire power supply				G3485 0000 700

Dupline® Industrial

Software			
Types	DUPDATAACC	DUP-SERV-ADD	DUP-SERV-SW
			
Functions	Software package with DDE-driver and ActiveXdriver for G3800. Controller and interface unit	A data logging, visualization and alarm handling software package to be installed in a windows based PC	A data logging, visualization and alarm handling software package to be installed in a windows based PC
Features	All Dupline® signal types. Copy and paste of dynamic Dupline links into EXCEL spreadsheets	Works only with G3800 xx36. Log and control energy consumption, analogue values and digital events and alarms	Works only with G3800 xx36. Log and control energy consumption, analogue values and digital events and alarms
References	DUPDATAACC	DUP-SERV-ADD	DUP-SERV-SW2
DDE-Server	DUPDATAACC		
Dupline-Online One License			DUP-SERV-SW
ADD-License to Dupline-Online		DUP-SERV-ADD	
Dupline-Online two license			DUP-SERV-SW2



Dupline® Industrial

Accessories

Types	GAP1605	GTU8	G3282 2002 230
			
Dimensions (mm)	120 x 65 x 22	145 x 90 x 28	77 x 36 x 70
Functions	Dupline® coding device for assigning addresses to Dupline® I/O modules and sensors	Dupline® test unit for monitoring and control of Dupline® channels	Dupline® bus separator
Housing type	Handheld	Handheld	H2 Housing
Electrical specifications			
Number of channels	NA	Adjusts automatically	2
Features/Signal types		Digital, multiplexed BCD, 8-bit analogue signals and split I/O. Also prepared to calibrate sensors in Carpark system	Disconnect the secondary side of the Dupline® bus when a short-circuit is detected
Power supply	9 V battery	Powered through the Dupline® network	230 V
General specifications			
Degree of protection	IP 40	IP 40	IP 20
Operating temperature	0°C to +50°C	0°C to +50°C	0°C to +50°C
Storage temperature	-20°C to +60°C	-20°C to +85°C	-20°C to +85°C
Remarks		Options for latching digital signals and for reading multiplexed BCD values	
References			
Programmer	GAP1605		
Display			
Monitoring and control unit	GTU8		
Bus separator	G3282 2002 230		

Dupline® Industrial

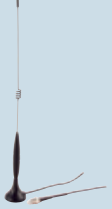
Accessories

Types	ADAPT 1605	ANT1	ANT2	D3212 4000
				
Dimensions (mm)	25 x 50 x 100		15 x 35 x 120	36 x 70 x 77
Functions	Codings adaptor between GAP1605 and Dupline® modules without standard connection plug	GSM antenna 900 MHz	Active antenna used for radio controlled clock	Synchronizer module for analogue modules
Housing type	Handheld box		Glued plastic casing	H2 housing
Electrical specifications				
Features/Signal types	4 clip-on terminals for Dupline® modules. Includes a M12 plug for modules like G8911 1010		Input signal is 77.5 kHz	Max. 112 analogue signals with up to 12 bit resolution
Power supply		Powered by G3800 XXXX	Powered by G3800 XXXX	Powered by Dupline®
General specifications				
Degree of protection	IP 20	IP 67	IP 40	IP 40
Operating temperature	0°C to +50°C	-25°C to +60°C	0°C to +50°C	-20°C to +50°
Storage temperature	-20°C to +60°C	-20°C to +60°C	-20°C to +60°C	-50°C to +85°C
Remarks				Transmits always on A1-A4
References				
Adaptor	ADAPT 1605			
Antenna		ANT1	ANT2	
Synchronizer				D3212 4000

Dupline® Industrial

Accessories

Types	DT01/DT02	ETHCONV 2	ETHCONV 3	ETHCONV 4
				

Dimensions (mm)	17.5 x 70 x 77	22 x 75.2 x 80	22 x 90 x 100.4	29 x 89.2 x 118.5
Functions	Cable termination unit	Ethernet to RS232 converter	Ethernet to RS232 converter	Ethernet to RS485 converter
Housing type	H1 housing	Metal housing	Metal housing	Plast housing

Electrical specifications

Number of channels		1	2	2
Features/Signal types	Removes distortion caused by reflection	1 port RJ45 10/100 Mbit TCP/IP based ethernet	2 port RJ45 10/100 Mbit TCP/IP based ethernet	2 port RJ45 10/100 Mbit TCP/IP based ethernet
Power supply	No power needed	12-48 VDC/130 mA	12-30 VDC/305 mA	12-30 VDC/305 mA





General specifications



Degree of protection	IP 20	IP 20	IP 20	IP 30
Operating temperature	-20°C to +50°C	0°C to +55°C	0°C to +55°C	0°C to +55°C
Storage temperature	-50°C to +85°C	-40°C to +75°C	-40°C to +75°C	-40°C to +75°C
Remarks		Automatic dedicated installation tool available	Automatic dedicated installation tool available	Automatic dedicated installation tool available

References

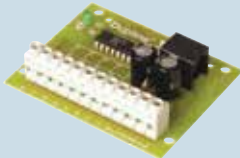
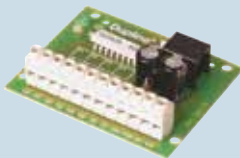

Standard Dupline®	DT01			
Hi-line Dupline®	DT02			
1 Channel		ETHCONV2		
2 Channels			ETHCONV3	ETHCONV4

Dupline® Irrigation

	Digital I/O modules		Converter	Tools
Types	GH3440 4412	GH6440 4412	GH3485 0000	GHTU8
				
Dimensions (mm)	77 x 72 x 70	80 x 77 x 50	77 x 72 x 70	145 x 90 x 28
Functions	I/O module for irrigation valve control	I/O module for irrigation valve control	Dupline® to Hi-Line converter	Dupline test unit for monitoring and control of Dupline® channels. Used for Hi-line modules
Housing type	DIN-Rail, H4	Fully molded housing for under ground installation	DIN-Rail, H4	Handheld
Electrical specifications				
Number of channels	4	4	Adjusts automatically	Adjusts automatically
Features/Signal types	2 outputs for control of 3-wire 12 VDC latching valve, and 2 contact inputs	2 outputs for control of 3-wire 12 VDC latching valve, and 2 contact inputs	Converts the Dupline® signal to Hi-Line 28 VDC level for control of irrigation valves (see GH3440 4412 and GH6440 4412)	Digital, multiplexed BCD and 8-bit analogue signals
Power supply	Powered through Hi-Line signal (see GH34850000)	Powered through Hi-Line signal (see GH34850000)	724 = 20-30 VDC	Powered through the Dupline® network
General specifications				
Degree of protection	IP 20	IP 67	IP 20	IP 40
Operating temperature	0°C to +50°C	0°C to +50°C	0°C to +50°C	0°C to +50°C
Storage temperature	-50°C to +85°C	-50°C to +85°C	-50°C to +85°C	-20°C to +85°C
Remarks				Options for latching digital signals and for reading multiplexed BCD values
References				
2 outputs and 2 inputs	GH3440 4412	GH6440 4412		
Converter			GH3485 0000	
Monitoring and control unit				GHTU8

Dupline® Elevator			
	Input module	Output module	Input/output module
Types	G2120	G2130	G2140 4421
			
Dimensions (mm)	Open PCB 72.3 x 59	Open PCB 74 x 59	Open PCB 54 x 40
Functions	8 contact inputs for push buttons or transistors. LED indications for supply and carrier	8 outputs for control of floor indicators and lamps. LED indications for supply and carrier	2 push button inputs. 2 PNP-transistor outputs. LED indications for supply and carrier
Housing type	Snap locks or DIN-rail (vertical or horizontal)	Snap locks or DIN-rail (vertical or horizontal)	Snap locks or DIN-rail (vertical or horizontal)
Electrical specifications			
Number of channels	8	8	4
Features/Signal types	3-wire operation with DC-power on wire 3	3-wire operation with DC-power on wire 3	3-wire operation with DC-power on wire 3
Power supply	700 = 10 - 30 VDC	700 = 10 - 30 VDC	700 = 10 - 30 VDC
General specifications			
Operating temperature	-20°C to +50°C	-20°C to +50°C	-20°C to +50°C
References			
NPN	G2120 5501 700	G2130 5511 700	
PNP	G2120 5502 700	G2130 5521 700	G2140 4421 700

Dupline® Elevator

	Input/output module	Master modules	
Types	G2140 55.0	G2196	G3496
			
Dimensions (mm)	Open PCB 74 x 59	Open PCB 86 x 54	77 x 72 x 70
Functions	4 push-button inputs 4 transistor outputs LED indications for supply and carrier	128 signals RS 485/RS 232 interface to control system LED indications for supply, carrier and RS485Tx	Plug & Play RS232/RS485 Interface with built-in protocols for specific PLC brands and Modbus
Housing type	Snap locks or DIN-rail (vertical or horizontal)	Snap locks or DIN-rail (vertical or horizontal)	DIN-Rail, H4
Electrical specifications			
Number of channels	8	128 inputs and 128 outputs	Selectable
Features/Signal types	3-wire operation with DC-power on 3 wires	3-wire operation with DC-power on 3 wires	Possibility for 3-wire operation with DC-power on 3 wires
Power supply	700 = 10 - 30 VDC	700 = 20 - 30 VDC	700 = 20 - 30 VDC
General specifications			
Degree of protection			IP 20
Operating temperature	-20°C to +50°C	-20°C to +60°C	0°C to +50°C
Storage temperature			-50°C to +85°C
Remarks			Built-in protocol for specific PLC brands for easy interfacing
References			
NPN	G2140 5510 700		
PNP	G2140 5520 700		
Standard protocol		G2196 0000 700	G3496 0000 700
Lucky Goldstar K-series		G2196 0001 700	G3496 0001 700
GE-Fanuc 90-30 series		G2196 0002 700	G3496 0002 700
Mitsubishi FX & A-series		G2196 0003 700	G3496 0003 700
Omron		G2196 0004 700	G3496 0004 700
Modbus RTU Slave		G2196 0005 700	G3496 0005 700
Allen-Bradley			G3496 0006 700
Schneider			G3496 0007 700
Koyo			G3496 0008 700
Matsushita			G3496 0009 700
Siemens			G3496 0010 700
Toshiba			G3496 0011 700
IDEC			G3496 0012 700

OUR SALES NETWORK IN EUROPE

AUSTRIA

Carlo Gavazzi GmbH
Ketzergasse 374,
A-1230 Wien
Tel: +43 1 888 4112
Fax: +43 1 889 10 53
office@carlogavazzi.at

BELGIUM

Carlo Gavazzi NV/SA
Mechelsesteenweg 311,
B-1800 Vilvoorde
Tel: +32 2 257 4120
Fax: +32 2 257 41 25
sales@carlogavazzi.be

DENMARK

Carlo Gavazzi Handel A/S
Over Hadstenevej 40,
DK-8370 Hadsten
Tel: +45 89 60 6100
Fax: +45 86 98 15 30
handel@gavazzi.dk

FINLAND

Carlo Gavazzi OY AB
Petaksentie 2-4,
FI-00630 Helsinki
Tel: +358 9 756 2000
Fax: +358 9 756 20010
myynti@gavazzi.fi

FRANCE

Carlo Gavazzi Sarl
Zac de Paris Nord II, 69, rue de la Belle Etoile,
F-95956 Roissy CDG Cedex
Tel: +33 1 49 38 98 60
Fax: +33 1 48 63 27 43
french.team@carlogavazzi.fr

GERMANY

Carlo Gavazzi GmbH
Pforstr. 10-14
D-64293 Darmstadt
Tel: +49 6151 81000
Fax: +49 6151 81 00 40
info@gavazzi.de

GREAT BRITAIN

Carlo Gavazzi UK Ltd
4.4 Frimley Business Park,
Frimley, Camberley, Surrey GU16 7SG
Tel: +44 1 276 854 110
Fax: +44 1 276 682 140
sales@carlogavazzi.co.uk

ITALY

Carlo Gavazzi SpA
Via Milano 13,
I-20020 Lainate
Tel: +39 02 931 761
Fax: +39 02 931 763 01
info@gavazziacbu.it

NETHERLANDS

Carlo Gavazzi BV
Wijkermeerweg 23,
NL-1948 NT Beverwijk
Tel: +31 251 22 9345
Fax: +31 251 22 60 55
info@carlogavazzi.nl

NORWAY

Carlo Gavazzi AS
Melkeveien 13,
N-3919 Porsgrunn
Tel: +47 35 93 0800
Fax: +47 35 93 08 01
post@gavazzi.no

PORTUGAL

Carlo Gavazzi Lda
Rua dos Jerónimos 38-B,
P-1400-212 Lisboa
Tel: +351 21 361 7060
Fax: +351 21 362 13 73
carlogavazzi@carlogavazzi.pt

SPAIN

Carlo Gavazzi SA
Avda. Iparraguirre, 80-82,
E-48940 Leioa (Bizkaia)
Tel: +34 94 480 4037
Fax: +34 94 431 6081
gavazzi@gavazzi.es

SWEDEN

Carlo Gavazzi AB
V:a Kyrkogatan 1,
S-652 24 Karlstad
Tel: +46 54 85 1125
Fax: +46 54 85 11 77
info@carlogavazzi.se

SWITZERLAND

Carlo Gavazzi AG
Verkauf Schweiz/Vente Suisse
Sumpfstrasse 3,
CH-6312 Steinhausen
Tel: +41 41 747 4535
Fax: +41 41 740 45 40
info@carlogavazzi.ch

OUR SALES NETWORK IN THE AMERICAS

USA

Carlo Gavazzi Inc.
750 Hastings Lane,
Buffalo Grove, IL 60089, USA
Tel: +1 847 465 6100
Fax: +1 847 465 7373
sales@carlogavazzi.com

CANADA

Carlo Gavazzi Inc.
2660 Meadowvale Boulevard,
Mississauga, ON L5N 6M6, Canada
Tel: +1 905 542 0979
Fax: +1 905 542 22 48
gavazzi@carlogavazzi.com

MEXICO

Carlo Gavazzi Mexico S.A. de C.V.
Calle La Montaña no. 28, Fracc. Los Pastores
Naucalpan de Juárez, EDOMEX CP 53340
Tel & Fax: +52.55.5373.7042
mexicosales@carlogavazzi.com

BRAZIL

Carlo Gavazzi Automação Ltda.
Av. Francisco Matarazzo, 1752
Conj 2108 - Barra Funda - São Paulo/SP
Tel: +55 11 3052 0832
Fax: +55 11 3057 1753
info@carlogavazzi.com.br

OUR SALES NETWORK IN ASIA AND PACIFIC

SINGAPORE

Carlo Gavazzi Automation Singapore Pte. Ltd.
61 Tai Seng Avenue #05-06
Print Media Hub @ Paya Lebar iPark
Singapore 534167
Tel: +65 67 466 990
Fax: +65 67 461 980
info@carlogavazzi.com.sg

MALAYSIA

Carlo Gavazzi Automation (M) SDN. BHD.
D12-06-G, Block D12,
Pusat Perdagangan Dana 1,
Jalan PJU 1A/46, 47301 Petaling Jaya,
Selangor, Malaysia.
Tel: +60 3 7842 7299
Fax: +60 3 7842 7399
sales@gavazzi-asia.com

CHINA

Carlo Gavazzi Automation
(China) Co. Ltd.
Unit 2308, 23/F.,
News Building, Block 1, 1002
Middle Shennan Zhong Road,
Shenzhen, China
Tel: +86 755 83699500
Fax: +86 755 83699300
sales@carlogavazzi.cn

HONG KONG

Carlo Gavazzi Automation
Hong Kong Ltd.
Unit 3 12/F Crown Industrial Bldg.,
106 How Ming St., Kwun Tong,
Kowloon, Hong Kong
Tel: +852 23041228
Fax: +852 23443689

OUR COMPETENCE CENTRES AND PRODUCTION SITES

DENMARK

Carlo Gavazzi Industri A/S
Hadsten

MALTA

Carlo Gavazzi Ltd
Zejtun

ITALY

Carlo Gavazzi Controls SpA
Belluno

LITHUANIA

Uab Carlo Gavazzi Industri Kaunas
Kaunas

CHINA

Carlo Gavazzi Automation (Kunshan) Co., Ltd.
Kunshan

HEADQUARTERS

Carlo Gavazzi Automation SpA
Via Milano, 13
I-20020 - Lainate (MI) - ITALY
Tel: +39 02 931 761
info@gavazziautomation.com



CARLO GAVAZZI
Automation Components

Energy to Components!

www.gavazziautomation.com

