



# Stainless Steel Devices

---

for chemical- and pharmaceutical industrie



## Chapter 15 - Stainless Steel Devices

| Description  | Pressure range        | Connection thread                            | Device        | Page  |
|--|-----------------------|--|---------------|-------|
| pressure regulator for clean room environment                      | 0.05 ... 2 / 4 bar    | M5, G $\frac{1}{8}$                          | RE1           | 15.02 |
| pressure regulator, many variations                                | 0.2 ... 1.8 / 9 bar   | G $\frac{1}{4}$                              | R364-S        | 15.03 |
| pressure regulator, "Midi" series                                  | 0.2 ... 4.0 / 17 bar  | G $\frac{1}{2}$                              | R10-S         | 15.03 |
| pressure regulator for many gases                                  | 0.1 ... 1.5 / 50 bar  | G $\frac{1}{8}$ - G2                         | R3000         | 15.04 |
| pressure regulator for liquids, FDA-approved                       | 0.2 ... 3 / 16 bar    | G $\frac{1}{4}$ - G1                         | REA           | 15.06 |
| volume booster   | 1 ... 15 / 50 bar     | G $\frac{1}{4}$ - G2                         | R3000-J       | 15.07 |
| high pressure regulator up to 380 bar                              | 0 ... 2 / 15 bar      | $\frac{1}{4}$ "NPT                           | RHB-S         | 15.08 |
| many variations, for many gases                                    | 1 ... 8 / 200 bar     | DIN 477 / G $\frac{1}{4}$ - G $1\frac{1}{4}$ | RH3000        | 15.09 |
| low pressure regulator   | 5 ... 45 /6000 mbar   | G $\frac{1}{2}$ - G2                         | R3100         | 15.10 |
| back pressure regulator for low pressure                           | 5 ... 45 /6000 mbar   | G $\frac{1}{2}$ - G2                         | D3100         | 15.11 |
| back pressure regulator, for many variations                       | 0.1 ... 1.5 / 50 bar  | G $\frac{1}{8}$ - G2                         | D3000         | 15.12 |
| pressure regulator, suitable for pharmacy                          | 0.25 ... 0.4 / 52 bar | G $\frac{1}{4}$ - G $2\frac{1}{2}$           | R70           | 15.14 |
| low pressure regulator, suitable for pharmacy                      | 4 ... 7 / 960 mbar    | G $\frac{1}{4}$ - G $2\frac{1}{2}$           | R74           | 15.16 |
| filter regulator for many gases                                    | 0.2 ... 3 / 15 bar    | G $\frac{1}{8}$ - G1                         | B3000         | 15.18 |
| filter regulator, "Mini" and "Midi" series                         | 0.2 ... 1.8 / 17 bar  | G $\frac{1}{4}$ , G $\frac{1}{2}$            | B548-S, B11-S | 15.19 |
| lubricator for compressed air, -40°C/-40°F up to +130°C/266°F max. | 50 bar                | G $\frac{1}{8}$ - G2                         | L3000         | 15.20 |
| compressed air filter, -40°C/-40°F up to +130°C/266°F              | max. 50 bar           | G $\frac{1}{8}$ - G2                         | F3000         | 15.21 |
| FRL service unit, 2- and 3-part                                    | 0.2 ... 3 / 15 bar    | G $\frac{1}{8}$ - G2                         | C3000         | 15.22 |
| FRL service unit, 2- and 3-part                                    | 0.3 ... 9 bar         | G $\frac{1}{2}$                              | C10-S         | 15.23 |
| compressed air filter  | max. 21 bar           | G $\frac{1}{4}$ , G $\frac{1}{2}$            | F504-S, F10-S | 15.23 |
| lubricator for compressed air                                      | max. 21 bar           | G $\frac{1}{2}$                              | L10-S         | 15.23 |
| pinch valve  | max. 4 bar            | G $\frac{1}{4}$ - G2                         | QE            | 15.24 |
| mounting flanges DIN and ANSI                                      | max. PN100            | G $\frac{1}{2}$ - G3                         | F.            | 15.25 |
| flanges and fittings   | max. PN100            | G $\frac{1}{2}$ - G3                         | VS            | 15.26 |



# 15

## Stainless Steel Devices

# Precision Pressure Regulator Made of Stainless Steel, for Pure Gases RE1

|                             |   |                          |         |
|-----------------------------|---|--------------------------|---------|
| <b>Description</b>          | Diaphragm pressure regulator made of stainless steel suitable for pure gases and panel mounting.  |                          |         |
| <b>Media</b>                | compressed air or gases   |                          |         |
| <b>Supply pressure</b>      | max. 10 bar   |                          |         |
| <b>Accuracy</b>             | setting accuracy: < 0.3% FS   | Repeatability:           | < 1% FS |
| <b>Air consumption</b>      | max. 0.5 l/min, subject to outlet pressure<br>The compressed air can be directly transmitted into the clean room without any piping.                          |                          |         |
| <b>Adjustment</b>           | by plastic knob with snap-lock  |                          |         |
| <b>Relieving function</b>   | relieving   | <b>Mounting position</b> | any     |
| <b>Gauge port</b>           | M5 or G $\frac{1}{8}$ on both sides of the body, depending on connection thread, screw plugs supplied   |                          |         |
| <b>Clean room condition</b> | Cleaned, assembled, inspected and sealed in a class 10,000 environment. All parts without oil use.<br>HFC1416 ultrasonic cleaning of all fluid-contact parts. |                          |         |
| <b>Temperature range</b>    | 0 °C to 60 °C / 32 °F to 140 °F   |                          |         |
| <b>Material</b>             | Body: stainless steel 316, material no. 1.4436  | Elastomer:               | FKM     |
|                             | Spring cage: PPS plastic  | Valve seat:              | PTFE    |

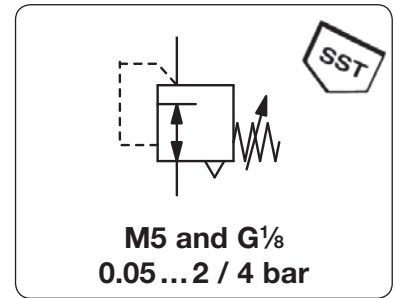

| Dimensions |   |   | K <sub>v</sub> -value<br>(m <sup>3</sup> /h) | Flow rate           |         | Connection thread<br>M5/G | Pressure range<br>bar | Order number |
|------------|---|---|--|---------------------|---------|---------------------------|-----------------------|--------------|
| A          | B | C |  | m <sup>3</sup> /h*1 | l/min*1 |                           |                       |              |

| Precision pressure Regulator |    |    |      |     |     |                 | supply pressure max. 10 bar, relieving, with constant bleed | RE1     |
|------------------------------|----|----|------|-----|-----|-----------------|---|---------|
| 30                           | 75 | 14 | 0.20 | 3.6 | 60  | M5              | 0.05 ... 2  | RE1-M5B |
|                              |    |    |      |     |     |                 | 0.10 ... 4  | RE1-M5C |
| 40                           | 75 | 15 | 0.25 | 6   | 100 | G $\frac{1}{8}$ | 0.05 ... 2  | RE1-01B |
|                              |    |    |      |     |     |                 | 0.10 ... 4  | RE1-01C |



RE1-M5C, incl. mounting nut

## Accessories, enclosed

|                  |                            |          |
|------------------|----------------------------|----------|
| mounting bracket | mounting nut at the device | BW30-04S |
|------------------|----------------------------|----------|



RE1-01C, inklusiv Befest.-Mutter

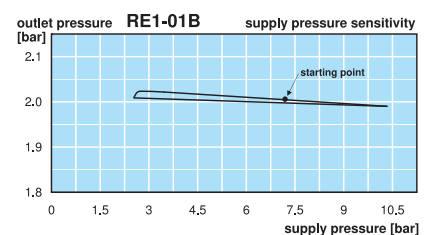
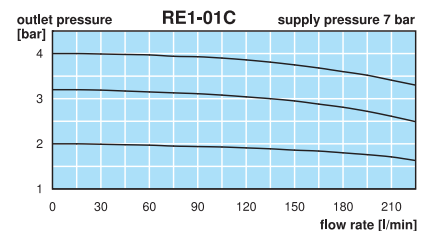
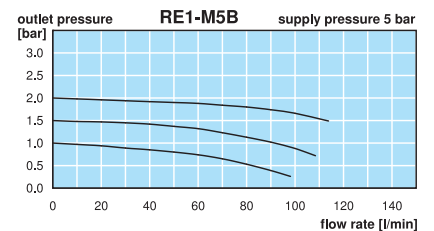
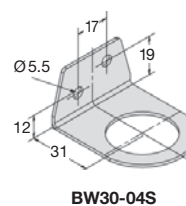
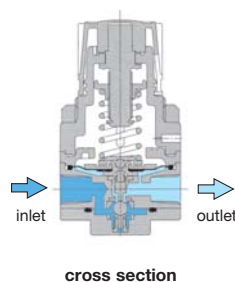
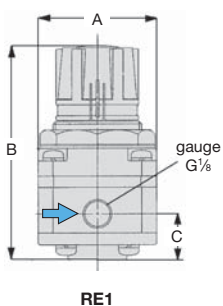

\*1 at 7 bar supply pressure and 4 bar outlet pressure

Gauges: see chapter for measuring devices

PDF CAD  
www.aircom.net

Order example:  
RE1-M5B

|                           |  |
|---------------------------|--|
| <b>Description</b>        | diaphragm-operated pressure regulator in small design  |
| <b>Media</b>              | compressed air, gases or liquids   |
| <b>Supply pressure</b>    | max. 21 bar  |
| <b>Adjustment</b>         | by plastic knob with snap-lock at R364 and R10, by hexagonal spindle at R354   |
| <b>Relieving function</b> | relieving, optionally non-relieving  |
| <b>Gauge port</b>         | G $\frac{1}{4}$ on both sides of the body, screw plugs supplied  |
| <b>Mounting position</b>  | any  |
| <b>Temperature range</b>  | 0 °C to 65 °C / 32 °F to 149 °F, for appropriately conditioned compressed air down to -30 °C / -22 °F<br>0 °C to 80 °C / 32 °F to 176 °F for spring cage made of fiberglass or stainless steel             |
| <b>Material</b>           | Body: stainless steel 316<br>Spring cage: glass fibre-reinforced plastic at R364 and R10, stainless steel 316 at R354, optionally fiberglass at R364<br>Elastomer: FKM<br>Inner valve: stainless steel 316 |

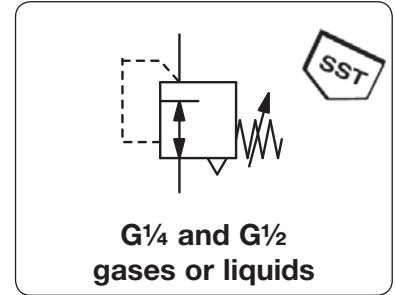

| Dimensions |   |   | Description | K <sub>v</sub> -value<br>(m <sup>3</sup> /h) | Flow rate<br>m <sup>3</sup> /h*1<br>l/min*1 | Connection thread<br>G | Pressure range<br>bar | Order number |
|------------|---|---|-------------|--|---|------------------------|-----------------------|--------------|
| A          | B | C |             |  |   |                        |                       |              |

| Stainless steel pressure regulator |    |    |                              |     |     |     |                 |   | supply pressure max. 21 bar            | R364-S |
|------------------------------------|----|----|------------------------------|-----|-----|-----|-----------------|---|--|--------|
| 40                                 | 75 | 13 | relieving for compressed air | 0.4 | 27  | 450 | G $\frac{1}{4}$ | 0.2 ... 1.8<br>0.2 ... 4.0<br>0.3 ... 9.0 | R364-02AS<br>R364-02BS<br>R364-02CS    |        |
| 40                                 | 75 | 13 | non-relieving for liquids    | 0.4 | 0.4 | 6   | G $\frac{1}{4}$ | 0.2 ... 1.8<br>0.2 ... 4.0<br>0.3 ... 9.0 | R364-02ASK<br>R364-02BSK<br>R364-02CSK |        |



R354-S

R364-S

| Stainless steel pressure regulator |     |    |                              |     |     |      |                 |  | supply pressure max. 21 bar         | R10-S |
|------------------------------------|-----|----|------------------------------|-----|-----|------|-----------------|--|-------------------------------------|-------|
| 60                                 | 124 | 35 | relieving for compressed air | 2.6 | 180 | 3000 | G $\frac{1}{2}$ | 0.2 ... 4.0<br>0.3 ... 9.0<br>0.5 ... 17 | R10-04BS<br>R10-04CS<br>R10-04DS    |       |
| 60                                 | 124 | 35 | non-relieving for liquids    | 2.6 | 2.6 | 43   | G $\frac{1}{2}$ | 0.2 ... 4.0<br>0.3 ... 9.0<br>0.5 ... 17 | R10-04BSK<br>R10-04CSK<br>R10-04DSK |       |



R10-S

### Special options, add the appropriate letter

|                                    |   |                |
|------------------------------------|---|----------------|
| <b>NPT</b>                         | connection thread   | R... -0... N   |
| <b>free of oil and grease</b>      | specially cleaned   | R3.4-0... L    |
| <b>stainless steel spring cage</b> | incl. stainless steel adjusting screw, total height 60 mm | R354-02... X57 |
| <b>fibreglass spring cage</b>      | max. 80 °C / 176 °F                                       | R364-02... X57 |

### Accessories, enclosed

|                         |  |          |                                |
|-------------------------|--|----------|--------------------------------|
| <b>pressure gauge</b>   | Ø 40 mm, 0... <sup>*2</sup> bar, G $\frac{1}{4}$ | for R364 | <b>MS4002-...<sup>*2</sup></b> |
| <b>pressure gauge</b>   | Ø 50 mm, 0... <sup>*2</sup> bar, G $\frac{1}{4}$ | for R10  | <b>MS5002-...<sup>*2</sup></b> |
| <b>mounting bracket</b> |  | for R364 | <b>BW30-04S</b>                |
| <b>mounting nut</b>     | made of stainless steel                          | for R364 | <b>M30x1,5S</b>                |
| <b>mounting nut</b>     | made of plastic                                  | for R364 | <b>M30x1,5K</b>                |
| <b>mounting bracket</b> |  | for R10  | <b>BW45-03S</b>                |
| <b>mounting nut</b>     |  | for R10  | <b>M45X1,5S</b>                |

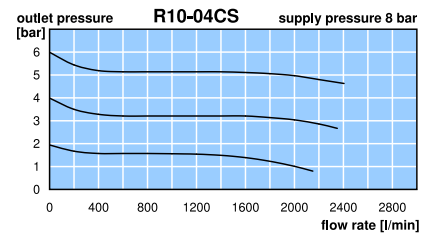
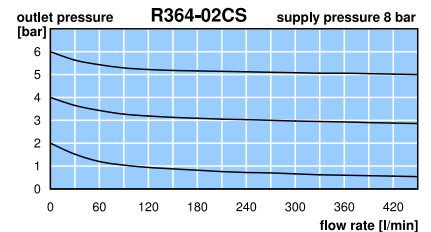
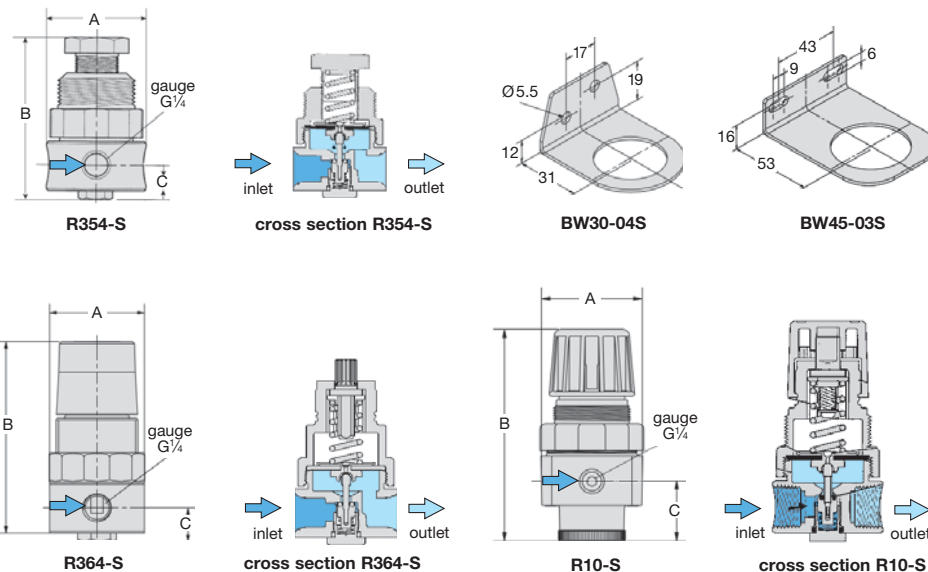

\*1 at 8 bar supply pressure, 6 bar outlet pressure and 1 bar pressure drop  
\*2 02 = 0...2.5 bar, 04 = 0...4 bar, 10 = 0...10 bar, 16 = 0...16 bar, 25 = 0...25 bar

Gauges: see chapter for measuring devices

PDF CAD  
www.aircom.net

Order example:  
R364-02AS



|                           |   |
|---------------------------|---|
| <b>Description</b>        | Pressure regulator made of stainless steel throughout.  |
| <b>Media</b>              | compressed air, gases or liquids  |
| <b>Supply pressure</b>    | see chart, max. 50 bar  |
| <b>Adjustment</b>         | by adjusting screw at R3000-01 to -A6, with locknut<br>by T-handle at R3000-06 to -16, with locknut   |
| <b>Relieving function</b> | non-relieving, optionally relieving   |
| <b>Gauge port</b>         | G $\frac{1}{8}$ at R3000-01 and -A2, all others G $\frac{1}{4}$ on both sides of the body, one screw plug supplied  |
| <b>Mounting position</b>  | any   |
| <b>Temperature range</b>  | 0 °C to 80 °C / 32 °C to 176 °F for FKM or EPDM<br>0 °C to 130 °C / 32 °C to 266 °F for high temperature version<br>for appropriately conditioned compressed air down to -20 °C / -4 °F or<br>low temperature version down to -40 °C / -40 °F |
| <b>Material</b>           | Body/inner valve: stainless steel 316L, material no. 1.4404<br>Diaphragm: NBR/Buna-N with PTFE coating, optionally stainless steel<br>O-rings: FKM, optionally EPDM   |

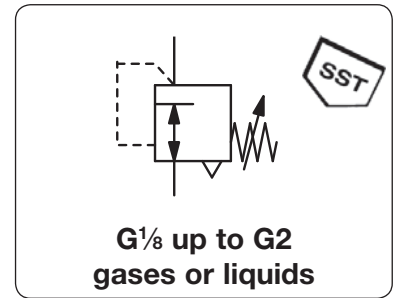

| Dimensions |    |    | Regul. system | K <sub>v</sub> -    | Flow                | Supply  | Connection | Pressure | Order  |
|------------|----|----|---------------|---------------------|---------------------|---------|------------|----------|--------|
| A          | B  | C  | D: diaphragm  | value               | rate                | max.    | thread     | range    | number |
| mm         | mm | mm | P: piston     | (m <sup>3</sup> /h) | m <sup>3</sup> /h*1 | l/min*1 | bar        | bar      |        |

| SST pressure regulator |     |    |   |     |     |      |    |                 |           | supply pressure max. 30/50 bar, non-relieving,<br>PTFE-diaphragm and FKM o-ring | R3000 |
|------------------------|-----|----|---|-----|-----|------|----|-----------------|-----------|---|-------|
| 40                     | 88  | 22 | D | 0.2 | 12  | 200  | 30 | G $\frac{1}{8}$ | 0.1...1.5 | R3000-01AT  |       |
|                        |     |    |   |     |     |      |    |                 | 0.2...3.0 | R3000-01BT  |       |
|                        |     |    |   |     |     |      |    |                 | 0.5...8.0 | R3000-01DT  |       |
|                        |     |    |   |     |     |      |    |                 | 1.0...15  | R3000-01ET  |       |
| 40                     | 88  | 22 | D | 0.2 | 12  | 200  | 30 | G $\frac{1}{4}$ | 0.1...1.5 | R3000-A2AT  |       |
|                        |     |    |   |     |     |      |    |                 | 0.2...3.0 | R3000-A2BT  |       |
|                        |     |    |   |     |     |      |    |                 | 0.5...8.0 | R3000-A2DT  |       |
|                        |     |    |   |     |     |      |    |                 | 1.0...15  | R3000-A2ET  |       |
| 64                     | 156 | 38 | D | 0.5 | 30  | 500  | 30 | G $\frac{1}{4}$ | 0.1...1.5 | R3000-02AT  |       |
|                        |     |    |   |     |     |      |    |                 | 0.2...3.0 | R3000-02BT  |       |
|                        |     |    |   |     |     |      |    |                 | 0.5...8.0 | R3000-02CT  |       |
|                        |     |    |   |     |     |      | 50 |                 | 1.0...15  | R3000-02DT  |       |
| 64                     | 176 | 38 | P | 0.5 | 30  | 500  | 50 |                 | 2.0...30  | R3000-02ET  |       |
|                        |     |    |   |     |     |      |    |                 | 3.0...50  | R3000-02FT  |       |
| 64                     | 156 | 38 | D | 0.5 | 30  | 500  | 30 | G $\frac{3}{8}$ | 0.1...1.5 | R3000-03AT  |       |
|                        |     |    |   |     |     |      |    |                 | 0.2...3.0 | R3000-03BT  |       |
|                        |     |    |   |     |     |      |    |                 | 0.5...8.0 | R3000-03CT  |       |
|                        |     |    |   |     |     |      | 50 |                 | 1.0...15  | R3000-03DT  |       |
| 64                     | 176 | 38 | P | 0.5 | 30  | 500  | 50 |                 | 2.0...30  | R3000-03ET  |       |
|                        |     |    |   |     |     |      |    |                 | 3.0...50  | R3000-03FT  |       |
| 79                     | 163 | 37 | D | 1.8 | 132 | 2200 | 30 | G $\frac{1}{2}$ | 0.1...1.5 | R3000-04AT  |       |
|                        |     |    |   |     |     |      |    |                 | 0.2...3.0 | R3000-04BT  |       |
|                        |     |    |   |     |     |      |    |                 | 0.5...8.0 | R3000-04CT  |       |
|                        |     |    |   |     |     |      | 50 |                 | 1.0...15  | R3000-04FT  |       |
| 79                     | 189 | 37 | P | 1.8 | 132 | 2200 | 50 |                 | 2.0...30  | R3000-04GT  |       |
|                        |     |    |   |     |     |      |    |                 | 3.0...50  | R3000-04LT  |       |
| 79                     | 163 | 37 | D | 1.8 | 132 | 2200 | 30 | G $\frac{3}{4}$ | 0.1...1.5 | R3000-A6AT  |       |
|                        |     |    |   |     |     |      |    |                 | 0.2...3.0 | R3000-A6BT  |       |
|                        |     |    |   |     |     |      |    |                 | 0.5...8.0 | R3000-A6CT  |       |
|                        |     |    |   |     |     |      | 50 |                 | 1.0...15  | R3000-A6FT  |       |
| 79                     | 189 | 37 | P | 1.8 | 132 | 2200 | 50 |                 | 2.0...30  | R3000-A6GT  |       |
|                        |     |    |   |     |     |      |    |                 | 3.0...50  | R3000-A6LT  |       |
| 126                    | 283 | 66 | D | 5.5 | 390 | 6500 | 30 | G $\frac{3}{4}$ | 0.1...1.5 | R3000-06AT  |       |
|                        |     |    |   |     |     |      |    |                 | 0.2...3.0 | R3000-06BT  |       |
|                        |     |    |   |     |     |      |    |                 | 0.5...8.0 | R3000-06CT  |       |
|                        |     |    |   |     |     |      | 50 |                 | 1.0...15  | R3000-06FT  |       |
| 126                    | 305 | 66 | P | 5.5 | 390 | 6500 | 50 |                 | 2.0...30  | R3000-06GT  |       |
|                        |     |    |   |     |     |      |    |                 | 3.0...50  | R3000-06LT  |       |
| 126                    | 283 | 66 | D | 5.5 | 390 | 6500 | 30 | G1              | 0.1...1.5 | R3000-08AT  |       |
|                        |     |    |   |     |     |      |    |                 | 0.2...3.0 | R3000-08BT  |       |
|                        |     |    |   |     |     |      |    |                 | 0.5...8.0 | R3000-08CT  |       |
|                        |     |    |   |     |     |      | 50 |                 | 1.0...15  | R3000-08FT  |       |
| 126                    | 305 | 66 | P | 5.5 | 390 | 6500 | 50 |                 | 2.0...30  | R3000-08GT  |       |
|                        |     |    |   |     |     |      |    |                 | 3.0...50  | R3000-08LT  |       |



\*1 at 8 bar supply pressure, 6 bar outlet pressure and 1 bar pressure drop

|                           |   |
|---------------------------|---|
| <b>Description</b>        | Pressure regulator made of stainless steel throughout.  |
| <b>Media</b>              | compressed air, gases or liquids  |
| <b>Supply pressure</b>    | see chart, max. 50 bar  |
| <b>Adjustment</b>         | by adjusting screw at R3000-01 to -A6, with locknut<br>by T-handle at R3000-06 to -16, with locknut   |
| <b>Relieving function</b> | non-relieving, optionally relieving   |
| <b>Gauge port</b>         | G $\frac{1}{4}$ at R3000-01 and -A2, all others G $\frac{1}{4}$ on both sides of the body, one screw plug supplied  |
| <b>Mounting position</b>  | any   |
| <b>Temperature range</b>  | 0 °C to 80 °C / 32 °C to 176 °F for FKM or EPDM<br>0 °C to 130 °C / 32 °C to 266 °F for high temperature version<br>for appropriately conditioned compressed air down to -20 °C / -4 °F or<br>low temperature version down to -40 °C / -40 °F |
| <b>Material</b>           | Body/inner valve: stainless steel 316L, material no. 1.4404<br>Diaphragm: NBR/Buna-N with PTFE coating, optionally stainless steel<br>O-rings: FKM, optionally EPDM   |

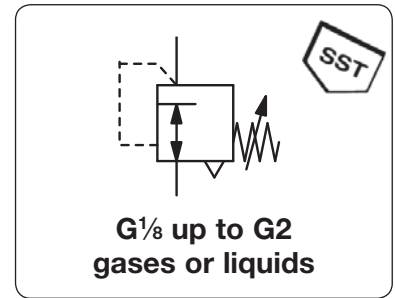

| Dimensions |    |    | Regul. system | K <sub>v</sub> -    | Flow                | Supply Connection | Pressure | Order  |
|------------|----|----|---------------|---------------------|---------------------|-------------------|----------|--------|
| A          | B  | C  | D: diaphragm  | value               | rate                | max.              | range    | number |
| mm         | mm | mm | P: piston     | (m <sup>3</sup> /h) | m <sup>3</sup> /h*1 | l/min*1           | bar      |        |

| SST pressure regulator |     |     | supply pressure max. 30/50 bar, non-relieving, PTFE-diaphragm and FKM o-ring |      |      |       |    | R3000            |             |            |
|------------------------|-----|-----|--|------|------|-------|----|------------------|-------------|------------|
| 121                    | 385 | 128 | K  | 12.6 | 900  | 15000 | 30 | G1 $\frac{1}{2}$ | 0.2 ... 3.0 | R3000-12BT |
|                        |     |     |  |      |      |       |    |                  | 0.5 ... 8.0 | R3000-12CT |
| 171                    | 400 | 128 |  |      |      |       | 50 |                  | 1.0 ... 15  | R3000-12ET |
|                        |     |     |  |      |      |       |    |                  | 2.0 ... 30  | R3000-12GT |
|                        |     |     |  |      |      |       |    |                  | 3.0 ... 50  | R3000-12LT |
| 171                    | 385 | 128 | K  | 12.6 | 900  | 15000 | 30 | G2               | 0.2 ... 3.0 | R3000-B6BT |
|                        |     |     |  |      |      |       |    |                  | 0.5 ... 8.0 | R3000-B6CT |
| 171                    | 400 | 128 |  |      |      |       | 50 |                  | 1.0 ... 15  | R3000-B6ET |
|                        |     |     |  |      |      |       |    |                  | 2.0 ... 30  | R3000-B6GT |
|                        |     |     |  |      |      |       |    |                  | 3.0 ... 50  | R3000-B6LT |
| 171                    | 410 | 128 | M  | 21.0 | 1500 | 25000 | 30 | G2               | 0.1 ... 1.5 | R3000-16AT |
|                        |     |     |  |      |      |       |    |                  | 0.5 ... 6.0 | R3000-16CT |
|                        |     |     |  |      |      |       |    |                  | 1.0 ... 15  | R3000-16DT |

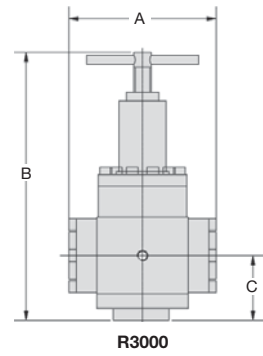

### Special options, add the appropriate letter

|   |                                   |  |               |
|---|-----------------------------------|--|---------------|
| <b>NPT connection thread</b>            |                                   |  | R3000-...N    |
| <b>relieving diaphragm</b>              |                                   | up to G1                                   | R3000-...R    |
| <b>relieving piston</b>                 |                                   |  | R3000-...R    |
| <b>up to -40 °C / -40 °F</b>            | low temperature version           | from G $\frac{1}{4}$ (02) on               | R3000-...X51  |
| <b>up to 130 °C / 266 °F</b>            | high temperature version          | from G $\frac{1}{4}$ (02) on               | R3000-...X54  |
| <b>FKM o-ring</b>                       | for piston or PTFE diaphragm      |  | R3000-...T    |
| <b>EPDM o-ring</b>                      |                                   |  | R3000-...TE   |
| <b>SST diaphragm</b>                    | FKM o-ring                        | for G $\frac{1}{4}$ (02) to G1             | R3000-...S    |
|   | EPDM o-ring                       | for G $\frac{1}{4}$ (02) to G1             | R3000-...SE   |
|   | EPDM o-ring, FDA-approved         | for G $\frac{1}{4}$ (02)                   | R3000-02...SD |
| <b>nitrogen N<sub>2</sub>: 07</b>       | <b>ammonia NH<sub>3</sub>: 02</b> | <b>carbon dioxide CO<sub>2</sub>:</b>      | R3000-...03   |
| <b>argon Ar: 05</b>                     | <b>helium He: 09</b>              | <b>hydrogen H<sub>2</sub>:</b>             | R3000-...11   |
| <b>methane CH<sub>4</sub>: 13</b>       | <b>oxygen O<sub>2</sub>: 15</b>   | <b>propane C<sub>3</sub>H<sub>8</sub>:</b> | R3000-...16   |
| <b>nitrous oxide N<sub>2</sub>O: 17</b> |                                   | <b>water H<sub>2</sub>O:</b>               | R3000-...W    |
| <b>flange connection</b>                | see end of the chapter / flanges  |  | R3000-...F.   |

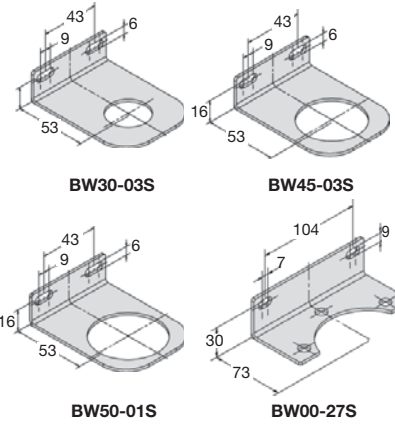

### Accessories, enclosed

|                         |                                      |  |                     |
|-------------------------|--------------------------------------|--|---------------------|
| <b>pressure gauge</b>   | Ø 40 mm, 0...*2 bar, G $\frac{1}{8}$ | for G $\frac{1}{4}$ and G $\frac{1}{4}$ (A2)     | <b>MS4001-...*2</b> |
|                         | Ø 50 mm, 0...*2 bar, G $\frac{1}{4}$ | for G $\frac{1}{4}$ (02) to G $\frac{3}{4}$ (A6) | <b>MS5002-...*2</b> |
|                         | Ø 63 mm, 0...*2 bar, G $\frac{1}{4}$ | for G $\frac{3}{4}$ (06) to G2                   | <b>MS6302-...*2</b> |
| <b>mounting bracket</b> |                                      | for G $\frac{1}{8}$ and G $\frac{1}{4}$ (A2)     | <b>BW30-03S</b>     |
| <b>mounting nut</b>     |                                      |  | <b>M30x1,5S</b>     |
| <b>mounting bracket</b> |                                      | for G $\frac{1}{4}$ (02) and G $\frac{3}{8}$     | <b>BW45-03S</b>     |
| <b>mounting nut</b>     |                                      |  | <b>M45x1,5S</b>     |
| <b>mounting bracket</b> |                                      | for G $\frac{1}{2}$ to G $\frac{3}{4}$ (A6)      | <b>BW50-01S</b>     |
| <b>mounting nut</b>     |                                      |  | <b>M50x1,5S</b>     |
| <b>mounting bracket</b> |                                      | for G $\frac{3}{4}$ (06) and G1                  | <b>BW00-27S</b>     |

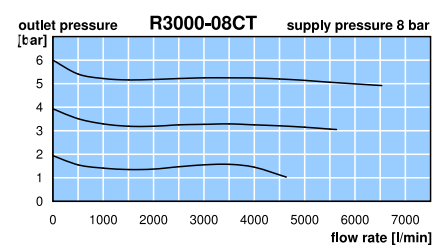

\*1 at 8 bar supply pressure, 6 bar outlet pressure and 1 bar pressure drop  
\*2 02 = 0...2.5 bar, 04 = 0...4 bar, 06 = 0...6 bar, 10 = 0...10 bar, 16 = 0...16 bar, 60 = 0...60 bar

# Pressure Regulator Made of Stainless Steel Throughout

REA

|                           |  |
|---------------------------|--|
| <b>Description</b>        | Diaphragm-operated pressure regulator made of stainless steel throughout. Even when spindle is unscrewed the indicated minimum outlet pressure is existent.  |
| <b>Media</b>              | compressed air, gases or liquids   |
| <b>Supply pressure</b>    | see chart, max. 25 bar   |
| <b>Adjustment</b>         | by T-handle, with locknut  |
| <b>Relieving function</b> | non-relieving  |
| <b>Gauge port</b>         | G $\frac{1}{4}$ on both sides of the body, one screw plug supplied   |
| <b>Mounting position</b>  | any  |
| <b>Temperature range</b>  | 0 °C to 90 °C / 32 °F to 194 °F for NBR, for appropriately conditioned compr. air down to -20 °C / - 4 °F<br>0 °C to 120 °C / 32 °F to 248 °F for FKM, for appropriately conditioned compr. air down to -30 °C / -22 °F<br>0 °C to 150 °C / 32 °F to 302 °F for EPDM, for appropriately conditioned compr. air down to -30 °C / -22 °F |
| <b>Material</b>           | Body: stainless steel 316L, mat. no. 1.4408<br>Diaphragm: FKM, optionally NBR/Buna-N, EPDM or PTFE   |

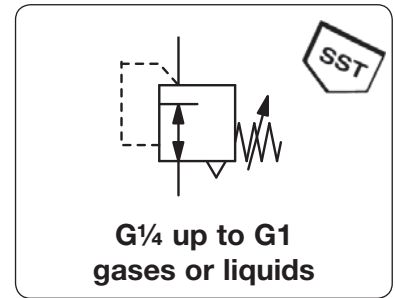

| Dimensions |   |   | K <sub>v</sub> -value | Flow rate           | Supply pressure | Connection thread | Pressure range | Order number |
|------------|---|---|-----------------------|---------------------|-----------------|-------------------|----------------|--------------|
| A          | B | C | (m <sup>3</sup> /h)   | m <sup>3</sup> /h*1 | l/min*1         | max. bar          | G              | bar          |

| SST pressure regulator |     |    |     |     |      |    | for liquids, supply pressure max. 8/25 bar, non-relieving, FKM | REA       |         |
|------------------------|-----|----|-----|-----|------|----|--|-----------|---------|
| 92                     | 200 | 42 | 1.0 | 66  | 1100 | 8  | G $\frac{1}{4}$  | 0.2...3.0 | REA-02B |
|                        |     |    |     |     |      | 25 |  | 2.0... 10 | REA-02D |
|                        |     |    |     |     |      | 25 |  | 6.0... 16 | REA-02E |
|                        |     |    |     |     |      | 8  | G $\frac{1}{2}$  | 0.2...3.0 | REA-04B |
|                        |     |    |     |     |      | 25 |  | 2.0... 10 | REA-04D |
|                        |     |    |     |     |      | 25 |  | 6.0... 16 | REA-04E |
| 122                    | 250 | 49 | 4.0 | 252 | 4200 | 8  | G $\frac{1}{2}$  | 0.2...3.0 | REA-A4B |
|                        |     |    |     |     |      | 25 |  | 2.0... 10 | REA-A4D |
|                        |     |    |     |     |      | 25 |  | 6.0... 16 | REA-A4E |
|                        |     |    |     |     |      | 8  | G $\frac{3}{4}$  | 0.2...3.0 | REA-06B |
|                        |     |    |     |     |      | 25 |  | 2.0... 10 | REA-06D |
|                        |     |    |     |     |      | 25 |  | 6.0... 16 | REA-06E |
|                        |     |    |     |     |      | 8  | G1   | 0.2...3.0 | REA-08B |
|                        |     |    |     |     |      | 25 |  | 2.0... 10 | REA-08D |
|                        |     |    |     |     |      | 25 |  | 6.0... 16 | REA-08E |



## Special options, add the appropriate letter

|                                 |  |           |
|---------------------------------|--|-----------|
| <b>gaseous media</b>            | non-relieving, height +17 mm (02 and 04) +23 mm (-A4 to -08) | REA-... U |
| <b>NBR/Buna-N diaphragm</b>     |  | REA-... H |
| <b>EPDM diaphragm</b>           | FDA approved   | REA-... E |
| <b>PTFE diaphragm</b>           | FKM with PTFE coating and FKM o-ring                         | REA-... I |
| <b>free of oil and grease</b>   | suitable for oxygen  | REA-... L |
| <b>flange connection*3</b>      | PN40, DN15 to DN25   | REA-... F |
| <b>welded hexagon nipples*3</b> | DIN 3239 / DIN 11850-2 / ISO 4200, DN8 to DN25               | REA-... A |
| <b>milk pipe connection</b>     |  | REA-... M |

## Accessories, enclosed

|                       |                                      |  |              |
|-----------------------|--------------------------------------|--|--------------|
| <b>pressure gauge</b> | Ø 50 mm, 0...*2 bar, G $\frac{1}{4}$ | for G $\frac{1}{4}$ and G $\frac{1}{2}$ (04) | MS5002-...*2 |
|                       | Ø 63 mm, 0...*2 bar, G $\frac{1}{4}$ | for G $\frac{1}{2}$ (A4) to G1               | MS6302-...*2 |

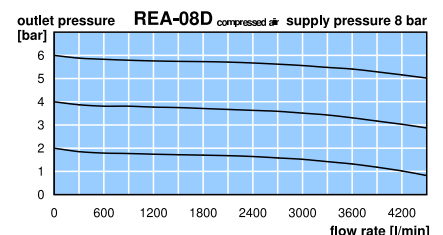
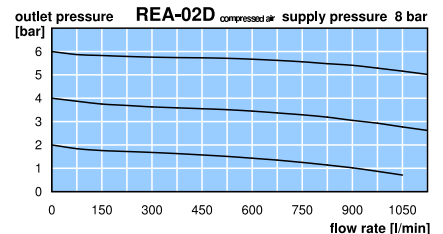
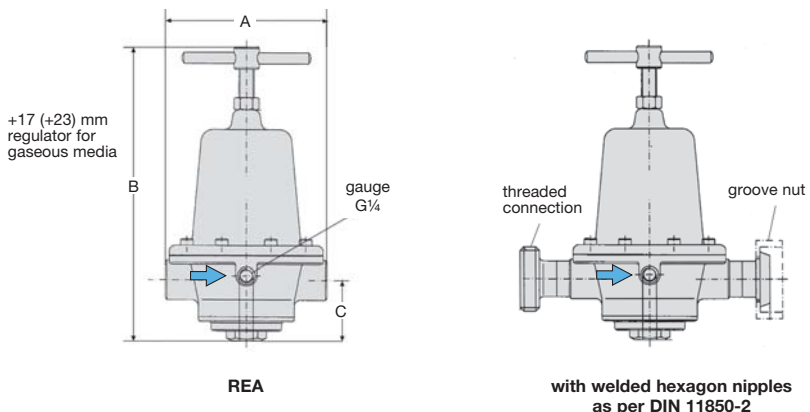

\*1 at 8 bar supply pressure, 6 bar outlet pressure and 1 bar pressure drop  
\*2 04 = 0...4 bar, 10 = 0...10 bar, 16 = 0...16 bar

\*3 version to be indicated in clear text

Gauges: see chapter for measuring devices

PDF CAD  
www.aircom.net

Order example:  
REA-02B



# Volume Booster Made of Stainless Steel Throughout, up to 50 bar

R3000-J

|                           |  |                             |                            |
|---------------------------|--|-----------------------------|----------------------------|
| <b>Description</b>        | Volume booster made of stainless steel throughout, without constant bleed, transmission ratio 1:1. |                             |                            |
| <b>Media</b>              | compressed air, gases or liquids   |                             |                            |
| <b>Supply voltage</b>     | max. 50 bar  |                             |                            |
| <b>Pilot pressure</b>     | max. 15 bar at R3000-...J2,  | max. 50 bar at R3000-...J5, | pilot port G $\frac{1}{4}$ |
| <b>Relieving function</b> | non-relieving, optionally relieving  |                             |                            |
| <b>Gauge port</b>         | Exhaust DN 2, optionally DN 4  |                             |                            |
| <b>Mounting position</b>  | G $\frac{1}{4}$ on both sides of the body, one screw plug supplied                                 |                             |                            |
| <b>Temperature range</b>  | any  |                             |                            |
|                           | 0 °C to 80 °C / 32 °C to 176 °F for FKM or EPDM  |                             |                            |
|                           | 0 °C to 130 °C / 32 °C to 266 °F for high temperature version                                      |                             |                            |
|                           | for appropriately conditioned compressed air down to -20 °C / -4 °F or                             |                             |                            |
|                           | low temperature version down to -40 °C / -40 °F  |                             |                            |
| <b>Material</b>           | Body: stainless steel 316L, material no. 1.4404  |                             |                            |
|                           | O-rings: FKM, optionally NBR/Buna-N or EPDM  |                             |                            |
|                           | Diaphragm: NBR/Buna-N with PTFE coating, optionally stainless steel                                |                             |                            |
|                           | Inner valve: stainless steel 316L, material no 1.4404  |                             |                            |

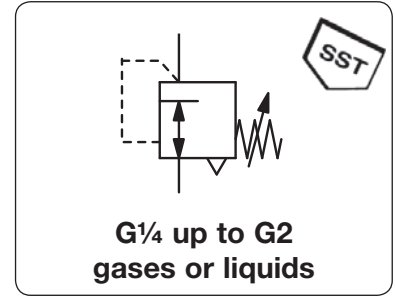

| Dimensions | Regulating System | K <sub>v</sub> -    | Flow                | Connection | Pilot    | Pressure | Order  |
|------------|-------------------|---------------------|---------------------|------------|----------|----------|--------|
| A B C      | M: Diaphragm      | value               | rate                | thread     | pressure | range    | number |
| mm mm mm   | K: Piston         | (m <sup>3</sup> /h) | m <sup>3</sup> /h*1 | G          | max. bar | bar      |        |

| Stainless steel booster |     |     |   |      |      |       | supply pressure max. 50 bar, non-relieving, ratio 1:1, PTFE diaphragm and FKM o-ring | R3000-J |        |             |
|-------------------------|-----|-----|---|------|------|-------|--|---------|--------|-------------|
| 64                      | 79  | 38  | M | 0.5  | 30   | 500   | G $\frac{1}{4}$  | 15      | 1...15 | R3000-02J2T |
| 64                      | 92  | 38  | K |      |      |       |  | 50      | 1...50 | R3000-02J5T |
| 80                      | 86  | 38  | M | 1.0  | 72   | 1200  | G $\frac{1}{2}$  | 15      | 1...15 | R3000-04J2T |
| 80                      | 107 | 38  | K |      |      |       |  | 50      | 1...50 | R3000-04J5T |
| 116                     | 136 | 65  | M | 5.0  | 360  | 6000  | G $\frac{3}{4}$  | 15      | 1...15 | R3000-06J2T |
| 116                     | 150 | 65  | K |      |      |       |  | 50      | 1...50 | R3000-06J5T |
| 116                     | 136 | 65  | M | 5.5  | 390  | 6500  | G1   | 15      | 1...15 | R3000-08J2T |
| 116                     | 150 | 65  | K |      |      |       |  | 50      | 1...50 | R3000-08J5T |
| 171                     | 237 | 128 | K | 12   | 840  | 14000 | G1 $\frac{1}{2}$   | 50      | 1...50 | R3000-12J5T |
| 171                     | 237 | 128 | K | 12.6 | 900  | 15000 | G2   | 50      | 1...50 | R3000-B6J5T |
| 171                     | 268 | 128 | K | 21   | 1500 | 25000 | G2   | 50      | 1...50 | R3000-16J5T |



R3000-02J2T, accessory: gauge



R3000-04J2T, accessory: gauge



R3000-08J2T, accessory: gauge

## Special options, add the appropriate letter or number

|                              |                                    |   |                                |                  |
|------------------------------|------------------------------------|---|--------------------------------|------------------|
| relieving diaphragm          |                                    |   | for R3000-02J2 to -08J2        | R3000-...J2..R   |
| relieving piston             |                                    |   | for R3000-12J, -16J and -...J5 | R3000-...J...R   |
| down to -40 °C / -40 °F      |                                    | low temperature version                 |                                | R3000-...J...X51 |
| up to 130 °C / 266 °F        |                                    | high temperature version                |                                | R3000-...J...X54 |
| FKM O-ring                   |                                    | for piston regulator or PTFE diaphragm  |                                | R3000-...J...T   |
| EPDM O-ring                  |                                    |   |                                | R3000-...J...TE  |
| SST diaphragm                | FKM                                | -O-Ring                                 |                                | R3000-...J...S   |
|                              | EPDM                               | -O-Ring                                 |                                | R3000-...J...SE  |
| tapped exhaust               |                                    |   |                                | R3000-...J...X12 |
| nitrogen N <sub>2</sub> : 07 | ammonia NH <sub>3</sub> : 02       | carbon dioxide CO <sub>2</sub> :        |                                | R3000-...J...03  |
| argon Ar: 05                 | helium He: 09                      | hydrogen H <sub>2</sub> :               |                                | R3000-...J...11  |
| methane CH <sub>4</sub> : 13 | oxygen O <sub>2</sub> : 15         | propane C <sub>3</sub> H <sub>8</sub> : |                                | R3000-...J...16  |
|                              | nitrous oxide N <sub>2</sub> O: 17 | water H <sub>2</sub> O:                 |                                | R3000-...J...W   |
| flange connection            |                                    | see end of the chapter / flanges        |                                | R3000-...J...F.  |

## Accessories, enclosed

|                  |  |   |                          |
|------------------|--|---|--------------------------|
| pressure gauge   | Ø 50 mm, 0... <sup>*2</sup> bar, G $\frac{1}{4}$ | for G $\frac{1}{4}$ and G $\frac{1}{2}$ | MS5002-... <sup>*2</sup> |
|                  | Ø 63 mm, 0... <sup>*2</sup> bar, G $\frac{1}{4}$ | for G $\frac{3}{4}$ to G2               | MS6302-... <sup>*2</sup> |
| mounting bracket |  | for G $\frac{3}{4}$ and G1              | BW00-27S                 |

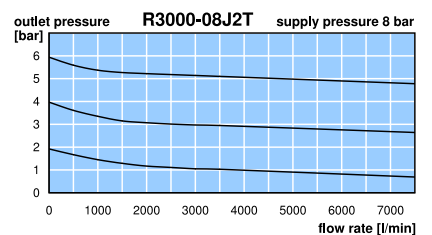
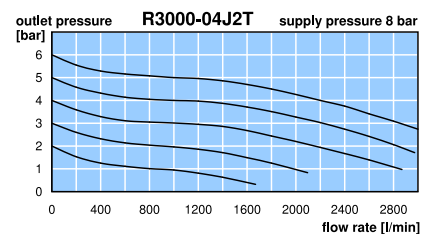
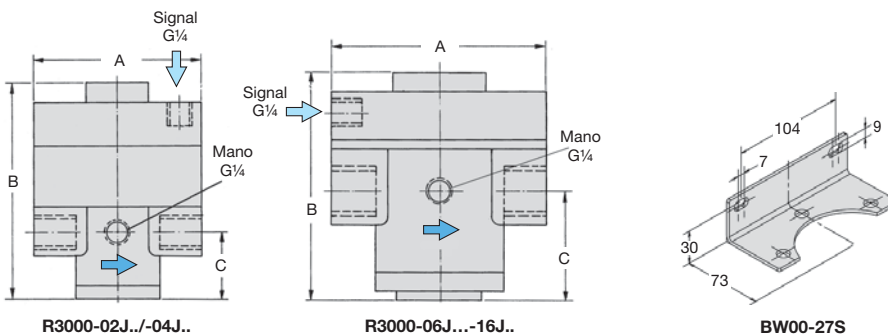

\*1 at 8 bar supply pressure, 6 bar outlet pressure and 1 bar pressure drop  
 \*2 02 = 0...2.5 bar, 04 = 0...4 bar, 06 = 0...6 bar, 10 = 0...10 bar, 16 = 0...16 bar, 60 = 0...60 bar

Gauges: see chapter for measuring devices

PDF CAD  
www.aircom.net

Order example:  
R3000-02J2T



# Stainless Steel High Pressure Regulator, up to 380 bar

RHB-S

|                           |  |   |  |
|---------------------------|--|---|--|
| <b>Description</b>        | Diaphragm-operated high pressure regulator made of stainless steel.                                    |   |  |
| <b>Media</b>              | compressed air or gases  |   |  |
| <b>Supply pressure</b>    | max. 380 bar   |   |  |
| <b>Adjustment</b>         | by T-handle with locknut   |   |  |
| <b>Relieving function</b> | non-relieving  |   |  |
| <b>Gauge port</b>         | 1/4" NPT on both sides of the body, screw plugs supplied   |   |  |
| <b>Mounting position</b>  | any  |   |  |
| <b>Temperature range</b>  | 0 °C to 106 °C / 32 °F to 223 °F, for appropriately conditioned compressed air down to -40 °C / -40 °F |   |  |
| <b>Material</b>           | Body: stainless steel 316, material no. 1.4401<br>Diaphragm: Monel 400                                 | O-rings: NBR/Buna-N<br>Valve seat: nylon, optionally PTFE |  |

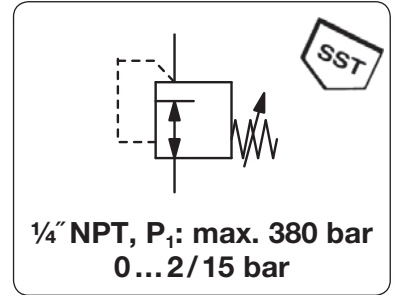

| Dimensions |   |   | K <sub>v</sub> -value<br>(m <sup>3</sup> /h) | Flow rate           |         | Connection thread<br>NPT | Pressure range<br>bar | Order number |
|------------|---|---|--|---------------------|---------|--------------------------|-----------------------|--------------|
| A          | B | C |  | m <sup>3</sup> /h*1 | l/min*1 |                          |                       |              |

| High pressure regulator, max. 380 bar |     |    |      |     |      |          | non-relieving,<br>without constant bleed | RHB-S    |
|---------------------------------------|-----|----|------|-----|------|----------|--|----------|
| 85                                    | 156 | 60 | 0.13 | 240 | 4000 | 1/4" NPT | 0.3 ... 2                                | RHB-02AS |
|                                       |     |    |      |     |      |          | 0.3 ... 4                                | RHB-02BS |
|                                       |     |    |      |     |      |          | 0.3 ... 8                                | RHB-02CS |
|                                       |     |    |      |     |      |          | 0.3 ... 10                               | RHB-02DS |
|                                       |     |    |      |     |      |          | 0.3 ... 15                               | RHB-02ES |



RHB-02DS

## Accessories, enclosed

|                         |   |             |
|-------------------------|---|-------------|
| <b>tamper-proof cap</b> | made of SST, adjustment by screwdriver, total height 150 mm | RHB-02 . ST |
| <b>PTFE valve seat</b>  |   | RHB-02 . S1 |



RHB-02DST, with tamper-proof cap

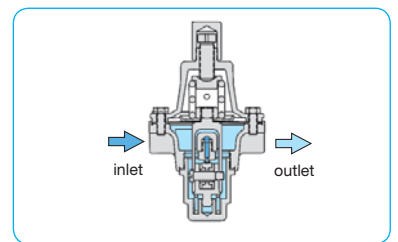

cross section

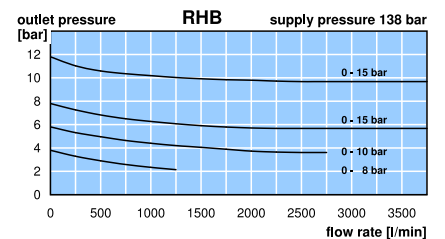
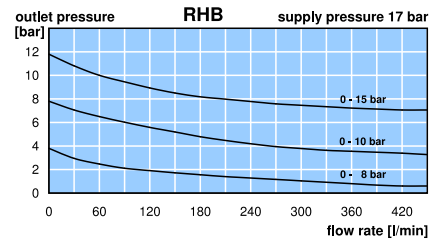
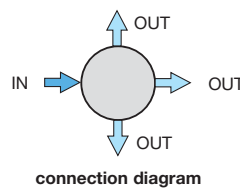
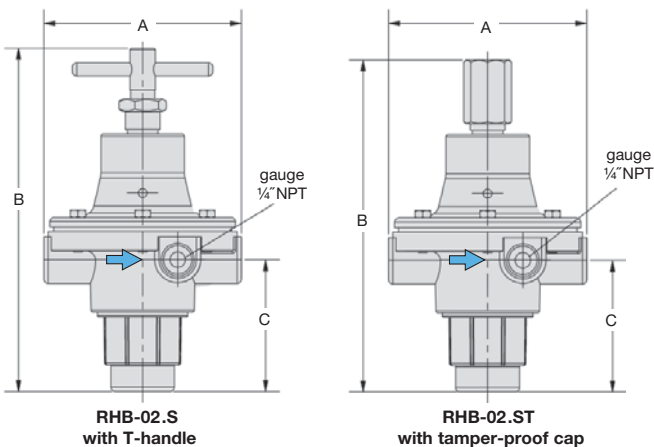

\*1 at 138 bar supply pressure and 10 bar outlet pressure

PDF CAD  
www.aircom.net

Order example:  
RHB-02AS



# Stainless Steel High Pressure Regulator, up to 200 bar Outlet Pressure RH3000

**Description** Hand-operated, spring-loaded high pressure regulator for maximum supply pressure of 220 bar and maximum outlet pressure of 200 bar. For outlet pressures up to 15 bar the regulator has a diaphragm, for higher outlets a piston. A sintered bronze filter at the inlet port protects against contamination.

**Media** compressed air or non-corrosive gases

**Supply pressure** max. 220 bar

**Adjustment** by hexagon head screw at RH3000-02, T-handle at RH3000-03 to -10, with locknut

**Gauge port** All regulators are equipped with both one supply pressure gauge and one outlet pressure gauge.

**Safety relief valve** prevents from overpressure, see chart

**Compensation** All regulators are equipped with supply pressure variation compensation, so that a change in supply pressure has no effect on the outlet pressure's stability.

**Temperature range** -20 °C to 60 °C / -4 °F to 140 °F

**Material** Body: stainless steel 316  
Diaphragm: stainless steel 316  
O-ring: FKM / PTFE

**Mounting position** any  
Filter: stainless steel 316  
Valve seat: FKM  
Piston: stainless steel 316

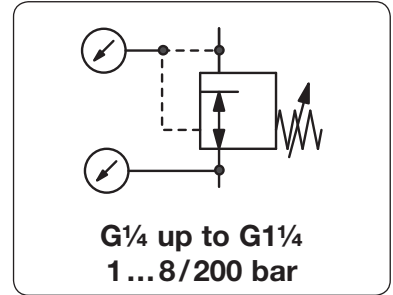

| Dimensions |    |    | Safety        | K <sub>v</sub> -    | Flow                | Connection   | Pressure | Order  |
|------------|----|----|---------------|---------------------|---------------------|--------------|----------|--------|
| A          | B  | C  | relief valve  | value               | rate                | thread       | range    | number |
| mm         | mm | mm | S: with valve | (m <sup>3</sup> /h) | m <sup>3</sup> /h*1 | inlet/outlet | bar      |        |

| High pressure regulator 200 bar |     |     |   |      |      |       | non-relieving, for compressed air, with supply and outlet pressure gauges |            | RH3000     |  |
|---------------------------------|-----|-----|---|------|------|-------|---|------------|------------|--|
| 175                             | 150 | 32  | S | 0.05 | 30   | 500   | DIN 477 / G 1/4   | 1 ... 8    | RH3000-02A |  |
|                                 |     |     | S |      | 45   | 750   |   | 1 ... 15   | RH3000-02B |  |
|                                 |     |     | S |      | 60   | 1000  |   | 3 ... 30   | RH3000-02C |  |
|                                 |     |     | S |      | 60   | 1000  |   | 5 ... 50   | RH3000-02D |  |
|                                 |     |     | S |      | 60   | 1000  |   | 10 ... 100 | RH3000-02E |  |
|                                 |     |     | - |      | 60   | 1000  |   | 20 ... 200 | RH3000-02F |  |
| 181                             | 165 | 40  | S | 0.15 | 70   | 1150  | DIN 477 / G 1/2 m   | 1 ... 8    | RH3000-03A |  |
|                                 |     |     | S |      | 155  | 2580  |   | 1 ... 15   | RH3000-03B |  |
|                                 |     |     | S |      | 210  | 3500  | DIN 477 / G 3/8   | 3 ... 30   | RH3000-03C |  |
| 181                             | 180 | 40  | S |      | 300  | 5000  |   | 5 ... 50   | RH3000-03D |  |
|                                 |     |     | - |      | 390  | 6500  |   | 20 ... 200 | RH3000-03F |  |
| 181                             | 230 | 40  | S | 0.25 | 370  | 6170  | DIN 477 / G 1/2 m   | 1 ... 15   | RH3000-A3B |  |
|                                 |     |     | S |      | 550  | 9170  | DIN 477 / G 3/8   | 3 ... 30   | RH3000-A3C |  |
|                                 |     |     | S |      | 650  | 10830 |   | 5 ... 50   | RH3000-A3D |  |
| 181                             | 180 | 40  | - |      | 700  | 11670 |   | 20 ... 200 | RH3000-A3F |  |
| 171                             | 355 | 232 | S | 1.5  | 600  | 10000 | G 3/4 m / G 3/4 m   | 1 ... 8    | RH3000-06A |  |
|                                 |     |     | S |      | 720  | 12000 |   | 1 ... 15   | RH3000-06B |  |
| 171                             | 380 | 257 | S |      | 850  | 14170 |   | 3 ... 30   | RH3000-06C |  |
|                                 |     |     | S |      | 1000 | 16670 |   | 5 ... 50   | RH3000-06D |  |
| 246                             | 376 | 245 | S | 2.5  | 1100 | 18330 | G1 m / G1 m   | 1 ... 8    | RH3000-08A |  |
|                                 |     |     | S |      | 1300 | 21670 |   | 1 ... 15   | RH3000-08B |  |
| 246                             | 412 | 281 | S |      | 1500 | 25000 |   | 3 ... 30   | RH3000-08C |  |
|                                 |     |     | S |      | 1650 | 27500 |   | 5 ... 50   | RH3000-08D |  |
|                                 |     |     | - |      | 1850 | 30830 |   | 20 ... 200 | RH3000-08F |  |
| 241                             | 380 | 264 | S | 3.5  | 2700 | 45000 | G1 m / G1 1/4   | 1 ... 8    | RH3000-10A |  |
|                                 |     |     | S |      | 3150 | 52500 |   | 1 ... 15   | RH3000-10B |  |
| 241                             | 418 | 299 | S |      | 3500 | 58330 |   | 5 ... 50   | RH3000-10D |  |



## Special options, add the appropriate letter or number

|                     |                     |                |                                    |               |                   |  |  |  |               |
|---------------------|---------------------|----------------|------------------------------------|---------------|-------------------|--|--|--|---------------|
| relieving diaphragm |                     |                |                                    |               |                   |  |  |  | RH3000-... R  |
| relieving piston    |                     |                |                                    |               |                   |  |  |  | RH3000-... R  |
| EPDM elastomer      |                     |                |                                    |               |                   |  |  |  | RH3000-... E  |
| for panel mounting  |                     |                |                                    |               |                   |  |  |  | RH3000-... P  |
| nitrogen            | N <sub>2</sub> : 07 | carbon dioxide | CO <sub>2</sub> : 03*2             | argon         | Ar:               |  |  |  | RH3000-... 05 |
| helium              | He: 09              | hydrogen       | H <sub>2</sub> : 11                | methane       | CH <sub>4</sub> : |  |  |  | RH3000-... 13 |
| oxygen              | O <sub>2</sub> : 15 | propane        | C <sub>3</sub> H <sub>8</sub> : 16 | nitrous oxide | N <sub>2</sub> O: |  |  |  | RH3000-... 17 |

## Accessories, enclosed

|                  |                      |                 |
|------------------|----------------------|-----------------|
| mounting bracket | for RH3000-02 to -A3 | <b>BW30-03S</b> |
| mounting nut     | for RH3000-02 to -A3 | <b>M30x1,5S</b> |
| mounting bracket | for RH3000-06        | <b>BW00-31S</b> |
|                  | for RH3000-08        | <b>BW00-35S</b> |

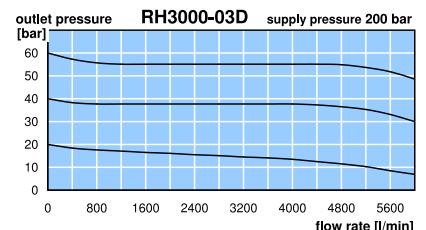
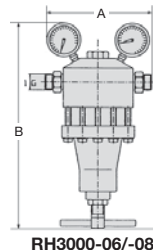
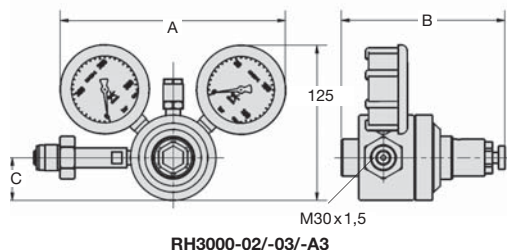

\*1 at 200 bar supply pressure and max. outlet pressure      \*2 max. 80 bar

|                           |   |  |
|---------------------------|---|--|
| <b>Description</b>        | Precision low pressure regulator with large diaphragm, completely made of stainless steel.        |  |
| <b>Media</b>              | compressed air or gases   |  |
| <b>Supply pressure</b>    | max. 6 bar  |  |
| <b>Air consumption</b>    | without constant bleed  |  |
| <b>Adjustment</b>         | by adjusting screw at R3100-04, with locknut<br>by T-handle at R3100-08 to -16, with locknut      |  |
| <b>Relieving function</b> | non-relieving   |  |
| <b>Gauge port</b>         | G $\frac{1}{4}$ on both sides of the body, one screw plug supplied                                |  |
| <b>Mounting position</b>  | any   |  |
| <b>Temperature range</b>  | 0 °C to 60 °C / 32 °F to 140 °F, for appropriately conditioned compr. air down to -20 °C / - 4 °F |  |
| <b>Material</b>           | Body: stainless steel 316L, material no. 1.4404<br>Diaphragm: NBR/Buna-N with PTFE coating        | O-rings: FKM<br>Inner valve: stainless steel 316L / 1.4404 |

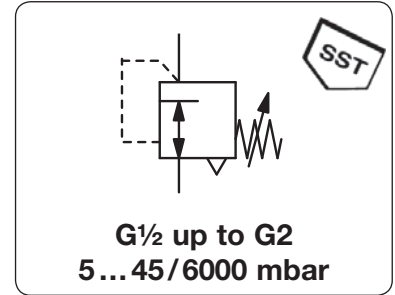

| Dimensions |   |   | K <sub>v</sub> -value<br>(m <sup>3</sup> /h) | Flow rate           |         | Connection thread<br>G | Pressure range<br>mbar | Order number |
|------------|---|---|--|---------------------|---------|------------------------|------------------------|--------------|
| A          | B | C |  | m <sup>3</sup> /h*1 | l/min*1 |                        |                        |              |

**Low pressure regulator** made of stainless steel, supply pressure max. 6 bar, non-relieving, PTFE diaphragm and FKM o-ring **R3100**

|     |     |     |     |     |      |                    |  |  |
|-----|-----|-----|-----|-----|------|--------------------|--|--|
| 80  | 177 | 37  | 0.4 | 36  | 600  | G $\frac{1}{2}$ *3 | 5 ... 45<br>20 ... 200<br>150 ... 700                  | <b>R3100-04A</b><br><b>R3100-04C</b><br><b>R3100-04D</b>                     |
| 126 | 311 | 66  | 1.8 | 180 | 3000 | G1                 | 20 ... 50<br>50 ... 100<br>100 ... 700<br>700 ... 6000 | <b>R3100-08A</b><br><b>R3100-08B</b><br><b>R3100-08D</b><br><b>R3100-08G</b> |
| 121 | 422 | 128 | 5.7 | 480 | 8000 | G1 $\frac{1}{2}$   | 20 ... 50<br>50 ... 150<br>150 ... 300<br>300 ... 3000 | <b>R3100-12A</b><br><b>R3100-12B</b><br><b>R3100-12D</b><br><b>R3100-12G</b> |
| 171 | 422 | 128 | 5.7 | 480 | 8000 | G2                 | 20 ... 50<br>50 ... 150<br>150 ... 300<br>300 ... 3000 | <b>R3100-16A</b><br><b>R3100-16B</b><br><b>R3100-16D</b><br><b>R3100-16G</b> |



**Special options,** add the appropriate letter or number

|                              |                                  |                              |   |              |
|------------------------------|----------------------------------|------------------------------|---|--------------|
| <b>NPT</b>                   |                                  | connection thread            |   | R3100-... N  |
| nitrogen N <sub>2</sub> : 07 |                                  | ammonia NH <sub>3</sub> : 02 | carbon dioxide CO <sub>2</sub> :        | R3100-... 03 |
| argon Ar: 05                 |                                  | helium He: 09                | hydrogen H <sub>2</sub> :               | R3100-... 11 |
| methane CH <sub>4</sub> : 13 |                                  | oxygen O <sub>2</sub> : 15   | propane C <sub>3</sub> H <sub>8</sub> : | R3100-... 16 |
|                              |                                  |                              | nitrous oxide N <sub>2</sub> O:         | R3100-... 17 |
| <b>flange connection</b>     | see end of the chapter / flanges |                              |   | R3100-... F. |

**Accessories,** enclosed

|  |  |                                   |  |
|--|--|-----------------------------------|--|
| <b>pressure gauge</b>                          | Ø 63 mm, 0 ... *2 mbar, G $\frac{1}{4}$ , capsule type | up to 600 mbar                    | <b>MS6302-... *2</b>                                     |
| <b>connection parts gauge mounting bracket</b> | Ø 63 mm, 0 ... *2 bar, G $\frac{1}{4}$ , Bourdon tube  | from 1 bar on for G $\frac{1}{2}$ | <b>MS6302-... *2</b><br><b>AM-03S</b><br><b>BW00-26S</b> |

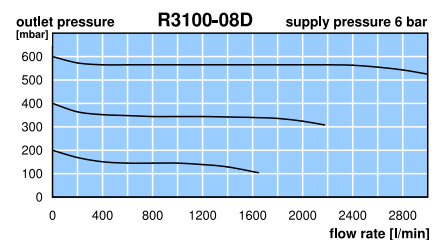
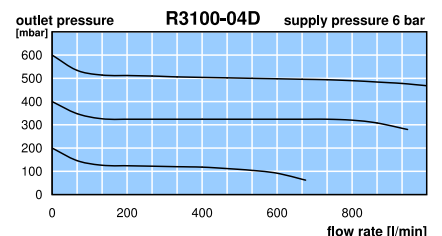
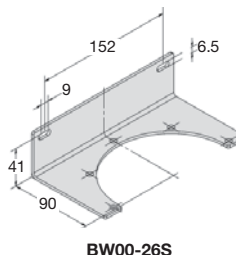
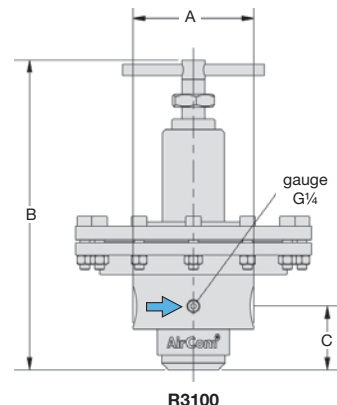

\*1 at 6 bar supply pressure and 1 bar pressure drop  
\*2 B6 = 0...60 mbar, C3 = 0...250 mbar, C4 = 0...400 mbar, C6 = 0...600 mbar, 02 = 0...2 bar, 04 = 0...4 bar, 06 = 0...6 bar  
\*3 G $\frac{1}{2}$  thread at outlet

|                          |   |
|--------------------------|---|
| <b>Description</b>       | The diaphragm back pressure regulator protects compressed air devices from excessive pressure. If the pressure setpoint is exceeded, overpressure is vented into the atmosphere until the setpoint is reached again. It is recommended to choose a pressure range as low as possible. |
| <b>Media</b>             | compressed air, gases or liquids  |
| <b>System pressure</b>   | max. 6 bar  |
| <b>Adjustment</b>        | by adjusting screw, with tamper-proof locknut   |
| <b>Gauge port</b>        | G $\frac{1}{4}$ on both sides of the body, screw plugs supplied   |
| <b>Mounting position</b> | any   |
| <b>Temperature range</b> | 0 °C to 80 °C / 32 °F to 176 °F FKM or EPDM,<br>for appropriately conditioned compressed air down to -20 °C / -4 °F   |
| <b>Material</b>          | Body: stainless steel 316L, material no. 1.4404<br>Diaphragm: NBR/Buna-N with PTFE coating, optionally stainless steel<br>O-rings: FKM, optionally NBR/Buna-N or EPDM<br>Inner valve: stainless steel 316L, material no. 1.4404   |

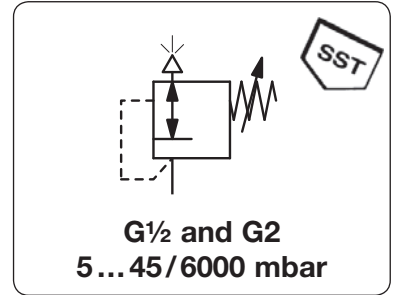

| Dimensions |    |    | Exhaust rate<br>l/min*1 | Over-pressure<br>max. bar | Connection<br>thread<br>G | Adjustment<br>range<br>mbar | Order<br>number |
|------------|----|----|-------------------------|---------------------------|---------------------------|-----------------------------|-----------------|
| A          | B  | C  |                         |                           |                           |                             |                 |
| mm         | mm | mm |                         |                           |                           |                             |                 |

| Back pressure regulator |     |     |       | overpressure max. 6 bar,<br>PTFE diaphragm and FKM o-ring |                 | D3100                         |
|-------------------------|-----|-----|-------|---|-----------------|-------------------------------|
| 80                      | 177 | 37  | 300   | 6   | G $\frac{1}{2}$ | 5... 45 <b>D3100-04AT</b>     |
|                         |     |     | 500   |   |                 | 20... 200 <b>D3100-04BT</b>   |
|                         |     |     | 1000  |   |                 | 150... 700 <b>D3100-04CT</b>  |
| 126                     | 310 | 66  | 800   | 6   | G1              | 20... 50 <b>D3100-08AT</b>    |
|                         |     |     | 1300  |   |                 | 50... 100 <b>D3100-08BT</b>   |
|                         |     |     | 2300  |   |                 | 100... 700 <b>D3100-08CT</b>  |
|                         |     |     | 5000  |   |                 | 600... 6000 <b>D3100-08DT</b> |
| 215                     | 407 | 128 | 2500  | 6   | G2              | 20... 50 <b>D3100-16AT</b>    |
|                         |     |     | 5000  |   |                 | 50... 150 <b>D3100-16BT</b>   |
|                         |     |     | 7500  |   |                 | 150... 300 <b>D3100-16CT</b>  |
|                         |     |     | 10000 |   |                 | 300... 3000 <b>D3100-16DT</b> |



stainless steel  
**SST**  
15

### Special options, add the appropriate letter or number

|                                    |                                    |                                 |             |
|------------------------------------|------------------------------------|---------------------------------|-------------|
| <b>NPT</b>                         | connection thread                  |                                 | D3100-...N  |
| <b>FKM o-ring</b>                  |                                    |                                 | D3100-...T  |
| <b>EPDM o-ring</b>                 |                                    |                                 | D3100-...TE |
| <b>nitrogen</b> N $_2$ : <b>07</b> | <b>ammonia</b> NH $_3$ : <b>02</b> | <b>carbon dioxide</b> CO $_2$ : | D3100-...03 |
| <b>argon</b> Ar: <b>05</b>         | <b>helium</b> He: <b>09</b>        | <b>hydrogen</b> H $_2$ :        | D3100-...11 |
| <b>methane</b> CH $_4$ : <b>13</b> | <b>oxygen</b> O $_2$ : <b>15</b>   | <b>propane</b> C $_3$ H $_8$ :  | D3100-...16 |
|                                    |                                    | <b>nitrous oxide</b> N $_2$ O:  | D3100-...17 |
| <b>flange connection</b>           | see end of the chapter / flanges   |                                 | D3100-...F. |

### Accessories, enclosed

|                               |  |                            |                     |
|-------------------------------|--|----------------------------|---------------------|
| <b>pressure gauge</b>         | Ø 63 mm, 0...*2 mbar, G $\frac{1}{4}$ , capsule type | for G $\frac{1}{2}$ and G1 | <b>MS6302-...*2</b> |
|                               | Ø 63 mm, 0...1 bar, G $\frac{1}{4}$ , Bourdon tube   | for G $\frac{1}{2}$ and G1 | <b>MS6302-01</b>    |
| <b>gauge connection parts</b> |  | for G $\frac{1}{2}$        | <b>AM-03S</b>       |
| <b>mounting bracket</b>       |  | for G $\frac{1}{2}$        | <b>BW00-26S</b>     |
|                               |  | for G1                     | <b>BW00-27S</b>     |

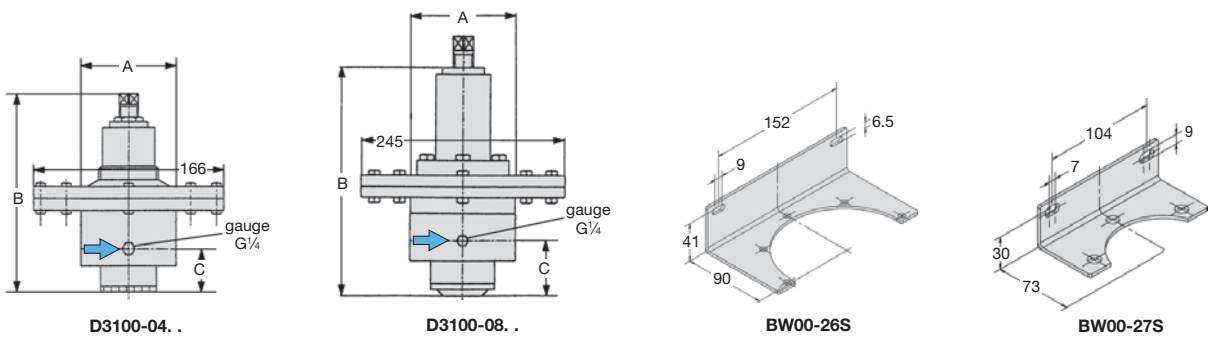

\*1 at 6 bar overpressure and open outlet  
\*2 B6 = 0...60 mbar, C3 = 0...250 mbar



**Description** The back pressure regulator protects compressed air devices from excessive pressure. If the pressure setpoint is exceeded, overpressure is vented into the atmosphere until the setpoint is reached again. It is recommended to choose a pressure range as low as possible.

**Media** compressed air, gases or liquids

**System pressure** see chart, max. 65 bar

**Adjustment** by adjusting screw at D3000-01 to -A6, with locknut  
by T-handle at D3000-06 to -16, with locknut

**Gauge port** for inlet pressure, G $\frac{1}{8}$  on both sides of the body at D3000-01, all others G $\frac{1}{4}$ , screw plugs supplied

**Mounting position** any

**Temperature range** 0 °C to 80 °C / 32 °C to 176 °F for FKM or EPDM  
0 °C to 130 °C / 32 °C to 266 °F for high temperature version  
for appropriately conditioned compressed air down to -20 °C / -4 °F or low temperature version down to -40 °C / -40 °F

**Material** Body: stainless steel 316L, material no 1.4404 O-rings: FKM, optionally NBR/Buna-N or EPDM  
Diaphragm: NBR/Buna-N with PTFE coating, optionally stainless steel  
Inner valve: stainless steel 316L, material no 1.4404

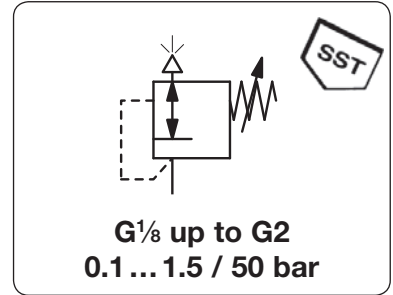

| Dimensions |    |    | Regul. system | Exhaust | Over-    | Connection | Adjustment | Order  |
|------------|----|----|---------------|---------|----------|------------|------------|--------|
| A          | B  | C  | D: Diaphragm  | rate    | pressure | thread     | range      | number |
| mm         | mm | mm | P: Piston     | l/min*1 | max. bar | G          | bar        |        |

| Back pressure regulator |     |    |   |      |    |                 |             | overpressure max. 30 / 65 bar,<br>PTFE diaphragm and FKM o-ring | D3000 |
|-------------------------|-----|----|---|------|----|-----------------|-------------|---|-------|
| 40                      | 82  | 13 | D | 200  | 30 | G $\frac{1}{8}$ | 0.1 ... 1.5 | D3000-01AT  |       |
|                         |     |    |   |      |    |                 | 0.2 ... 3.0 | D3000-01BT  |       |
|                         |     |    |   |      |    |                 | 0.5 ... 8.0 | D3000-01DT  |       |
|                         |     |    |   |      |    |                 | 1.0 ... 15  | D3000-01ET  |       |
| 40                      | 82  | 13 | D | 200  | 30 | G $\frac{1}{4}$ | 0.1 ... 1.5 | D3000-A2AT  |       |
|                         |     |    |   |      |    |                 | 0.2 ... 3.0 | D3000-A2BT  |       |
|                         |     |    |   |      |    |                 | 0.5 ... 8.0 | D3000-A2DT  |       |
|                         |     |    |   |      |    |                 | 1.0 ... 15  | D3000-A2ET  |       |
| 64                      | 156 | 38 | D | 300  | 30 | G $\frac{1}{4}$ | 0.1 ... 1.5 | D3000-02AT  |       |
|                         |     |    |   |      |    |                 | 0.2 ... 3.0 | D3000-02BT  |       |
|                         |     |    |   |      |    |                 | 0.5 ... 8.0 | D3000-02DT  |       |
|                         |     |    |   |      |    |                 | 1.0 ... 15  | D3000-02ET  |       |
| 64                      | 176 | 38 | P | 300  | 65 |                 | 2.0 ... 30  | D3000-02FT  |       |
|                         |     |    |   |      |    |                 | 3.0 ... 50  | D3000-02GT  |       |
| 64                      | 156 | 38 | D | 300  | 30 | G $\frac{3}{8}$ | 0.1 ... 1.5 | D3000-03AT  |       |
|                         |     |    |   |      |    |                 | 0.2 ... 3.0 | D3000-03BT  |       |
|                         |     |    |   |      |    |                 | 0.5 ... 8.0 | D3000-03DT  |       |
|                         |     |    |   |      |    |                 | 1.0 ... 15  | D3000-03ET  |       |
| 64                      | 176 | 38 | P | 300  | 65 |                 | 2.0 ... 30  | D3000-03FT  |       |
|                         |     |    |   |      |    |                 | 3.0 ... 50  | D3000-03GT  |       |
| 79                      | 163 | 37 | D | 1500 | 30 | G $\frac{1}{2}$ | 0.1 ... 1.5 | D3000-04AT  |       |
|                         |     |    |   |      |    |                 | 0.2 ... 3.0 | D3000-04BT  |       |
|                         |     |    |   |      |    |                 | 0.5 ... 8.0 | D3000-04DT  |       |
|                         |     |    |   |      |    |                 | 1.0 ... 15  | D3000-04ET  |       |
| 79                      | 163 | 37 | P | 1500 | 65 |                 | 2.0 ... 30  | D3000-04FT  |       |
|                         |     |    |   |      |    |                 | 3.0 ... 50  | D3000-04GT  |       |
| 79                      | 163 | 37 | D | 1500 | 30 | G $\frac{3}{4}$ | 0.1 ... 1.5 | D3000-A6AT  |       |
|                         |     |    |   |      |    |                 | 0.2 ... 3.0 | D3000-A6BT  |       |
|                         |     |    |   |      |    |                 | 0.5 ... 8.0 | D3000-A6DT  |       |
|                         |     |    |   |      |    |                 | 1.0 ... 15  | D3000-A6ET  |       |
| 79                      | 163 | 37 | P | 1500 | 65 |                 | 2.0 ... 30  | D3000-A6FT  |       |
|                         |     |    |   |      |    |                 | 3.0 ... 50  | D3000-A6GT  |       |
| 126                     | 283 | 66 | D | 6000 | 30 | G $\frac{3}{4}$ | 0.1 ... 1.5 | D3000-06AT  |       |
|                         |     |    |   |      |    |                 | 0.2 ... 3.0 | D3000-06BT  |       |
|                         |     |    |   |      |    |                 | 0.5 ... 8.0 | D3000-06DT  |       |
|                         |     |    |   |      |    |                 | 1.0 ... 15  | D3000-06ET  |       |
| 126                     | 305 | 66 | P | 6000 | 65 |                 | 2.0 ... 30  | D3000-06FT  |       |
|                         |     |    |   |      |    |                 | 3.0 ... 50  | D3000-06GT  |       |



D3000-01DT



D3000-02AT



D3000-04DT



\* at 7 bar overpressure and open outlet



|                          |   |
|--------------------------|---|
| <b>Description</b>       | The back pressure regulator protects compressed air devices from excessive pressure. If the pressure setpoint is exceeded, overpressure is vented into the atmosphere until the setpoint is reached again. It is recommended to choose a pressure range as low as possible. |
| <b>Media</b>             | compressed air, gases or liquids  |
| <b>System pressure</b>   | see chart, max. 65 bar  |
| <b>Adjustment</b>        | by adjusting screw at D3000-01 to -A6, with locknut<br>by T-handle at D3000-06 to -16, with locknut   |
| <b>Gauge port</b>        | for inlet pressure, G $\frac{1}{8}$ on both sides of the body at D3000-01, all others G $\frac{1}{4}$ , screw plugs supplied  |
| <b>Mounting position</b> | any   |
| <b>Temperature range</b> | 0 °C to 80 °C / 32 °C to 176 °F for FKM or EPDM<br>0 °C to 130 °C / 32 °C to 266 °F for high temperature version<br>for appropriately conditioned compressed air down to -20 °C / -4 °F or<br>low temperature version down to -40 °C / -40 °F                               |
| <b>Material</b>          | Body: stainless steel 316L, material no 1.4404 O-rings: FKM, optionally NBR/Buna-N or EPDM<br>Diaphragm: NBR/Buna-N with PTFE coating, optionally stainless steel<br>Inner valve: stainless steel 316L, material no 1.4404  |

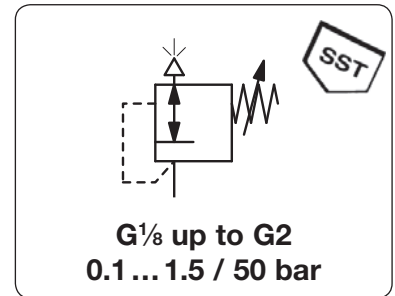

| Dimensions |    |    | Regul. system | Exhaust | Over-    | Connection | Adjustment | Order  |
|------------|----|----|---------------|---------|----------|------------|------------|--------|
| A          | B  | C  | D: Diaphragm  | rate    | pressure | thread     | range      | number |
| mm         | mm | mm | P: Piston     | l/min*1 | max. bar | G          | bar        |        |

| Back pressure regulator |     |    |   | overpressure max. 30 / 65 bar,<br>PTFE diaphragm and FKM o-ring | D3000 |                 |             |                   |
|-------------------------|-----|----|---|---|-------|-----------------|-------------|-------------------|
| 126                     | 283 | 66 | D | 6000  | 30    | G1              | 0.1 ... 1.5 | <b>D3000-08AT</b> |
|                         |     |    |   |   |       |                 | 0.2 ... 3.0 | <b>D3000-08BT</b> |
|                         |     |    |   |   |       |                 | 0.5 ... 8.0 | <b>D3000-08DT</b> |
|                         |     |    |   |   |       |                 | 1.0 ... 15  | <b>D3000-08ET</b> |
| 126                     | 305 | 66 | P | 6000  | 65    |                 | 2.0 ... 30  | <b>D3000-08FT</b> |
|                         |     |    |   |   |       |                 | 3.0 ... 50  | <b>D3000-08GT</b> |
| 200                     | 348 | 87 | P | 16000   | 30    | G $\frac{1}{2}$ | 0.1 ... 1.5 | <b>D3000-12AT</b> |
|                         |     |    |   |   |       |                 | 0.2 ... 3.0 | <b>D3000-12BT</b> |
|                         |     |    |   |   |       |                 | 0.5 ... 8.0 | <b>D3000-12DT</b> |
|                         |     |    |   |   |       |                 | 1.0 ... 15  | <b>D3000-12ET</b> |
| 200                     | 348 | 87 | P | 16000   | 65    |                 | 2.0 ... 30  | <b>D3000-12FT</b> |
|                         |     |    |   |   |       |                 | 3.0 ... 50  | <b>D3000-12GT</b> |
| 200                     | 348 | 87 | P | 16000   | 30    | G2              | 0.1 ... 1.5 | <b>D3000-16AT</b> |
|                         |     |    |   |   |       |                 | 0.2 ... 3.0 | <b>D3000-16BT</b> |
|                         |     |    |   |   |       |                 | 0.5 ... 8.0 | <b>D3000-16DT</b> |
|                         |     |    |   |   |       |                 | 1.0 ... 15  | <b>D3000-16ET</b> |
| 200                     | 348 | 87 | P | 16000   | 65    |                 | 2.0 ... 30  | <b>D3000-16FT</b> |
|                         |     |    |   |   |       |                 | 3.0 ... 50  | <b>D3000-16GT</b> |



D3000-08DT

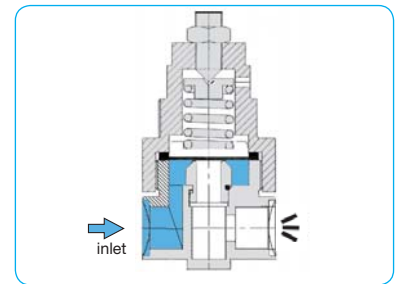

with diaphragm

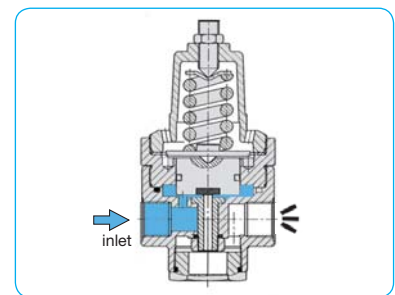

with piston

## Special options, add the appropriate letter or number

|  |                                      |  |              |
|--|--------------------------------------|--|--------------|
| <b>NPT</b>                                 | connection thread                    |  | D3000-...N   |
| <b>relieving diaphragm</b>                 |                                      | up to G1   | D3000-...R   |
| <b>relieving piston</b>                    |                                      |  | D3000-...R   |
| <b>up to -40 °C / -40 °F</b>               | low temperature version              | from G $\frac{1}{4}$ (02) on                     | D3000-...X51 |
| <b>up to 130 °C / 266 °F</b>               | high temperature version             | from G $\frac{1}{4}$ (02) on                     | D3000-...X54 |
| <b>FKM o-ring</b>                          | for piston or PTFE diaphragm         |  | D3000-...T   |
| <b>EPDM o-ring</b>                         |                                      |  | D3000-...TE  |
| <b>SST diaphragm</b>                       | FKM o-ring                           | for G $\frac{1}{4}$ (02) to G1                   | D3000-...S   |
|  | NBR o-ring                           | for G $\frac{1}{4}$ (02) to G1                   | D3000-...SB  |
|  | EPDM o-ring                          | for G $\frac{1}{4}$ (02) to G1                   | D3000-...SE  |
|  | EPDM o-ring, FDA approved            | for G $\frac{1}{4}$ (02)                         | D3000-02.SD  |
| <b>nitrogen N<math>_2</math>: 07</b>       | <b>ammonia NH<math>_3</math>: 02</b> | <b>carbon dioxide CO<math>_2</math>:</b>         | D3000-...03  |
| <b>argon Ar: 05</b>                        | <b>helium He: 09</b>                 | <b>hydrogen H<math>_2</math>:</b>                | D3000-...11  |
| <b>methane CH<math>_4</math>: 13</b>       | <b>oxygen O<math>_2</math>: 15</b>   | <b>propane C<math>_3</math>H<math>_6</math>:</b> | D3000-...16  |
| <b>nitrous oxide N<math>_2</math>O: 17</b> |                                      | <b>water H<math>_2</math>O:</b>                  | D3000-...W   |
| <b>flange connection</b>                   | see end of the chapter / flanges     |  | D3000-...F.  |

## Accessories, enclosed

|                         |                                      |  |                     |
|-------------------------|--------------------------------------|--|---------------------|
| <b>pressure gauge</b>   | Ø 40 mm, 0...*2 bar, G $\frac{1}{8}$ | for G $\frac{1}{8}$ and G $\frac{1}{4}$ (A2)     | <b>MS4001-...*2</b> |
|                         | Ø 50 mm, 0...*2 bar, G $\frac{1}{4}$ | for G $\frac{1}{4}$ (02) to G $\frac{3}{4}$ (A6) | <b>MS5002-...*2</b> |
|                         | Ø 63 mm, 0...*2 bar, G $\frac{1}{4}$ | for G $\frac{3}{4}$ (06) to G2                   | <b>MS6302-...*2</b> |
| <b>mounting bracket</b> |                                      | for G $\frac{1}{8}$ and G $\frac{1}{4}$ (A2)     | <b>BW30-03S</b>     |
| <b>mounting nut</b>     |                                      |  | <b>M30x1,5S</b>     |
| <b>mounting bracket</b> |                                      | for G $\frac{1}{4}$ (02) and G $\frac{3}{8}$     | <b>BW45-03S</b>     |
| <b>mounting nut</b>     |                                      |  | <b>M45x1,5S</b>     |
| <b>mounting bracket</b> |                                      | for G $\frac{1}{2}$ to G $\frac{3}{4}$ (A6)      | <b>BW50-01S</b>     |
| <b>mounting nut</b>     |                                      |  | <b>M50x1,5S</b>     |
| <b>mounting bracket</b> |                                      | for G $\frac{3}{4}$ (06) and G1                  | <b>BW00-27S</b>     |

\* at 7 bar overpressure and open outlet

Gauges: see chapter for measuring devices

PDF CAD  
www.aircom.net



Order example:  
D3000-08AT

**Description** Piston-operated pressure regulator made of stainless steel up to pressure range of 52 bar, independent to inlet pressure.

**Note** It is recommended to select an outlet diameter at least one time larger than the main valve's diameter.

**Media** compressed air, gases, liquids or steam (R70-02 not suitable for steam)

**Supply pressure** max. 16 bar at R70-02, max. 40 bar at R70-16/-20, max. 63 bar at R70-03/-06 to -12, max. 100 bar at R70-04

**Adjustment** by wing screw at R70-02, with locknut  
by T-handle at R70-03 to -20, with locknut

**Relieving function** non-relieving

**Gauge port** G1/4 on both sides of the body

**Temperature range** 0 °C to 140 °C / 32 °F to 284 °F, EPDM, steamable, 0 °C to 150 °C / 32 °F to 302 °F, PTFE/EPDM for steam, 0 °C to 200 °C / 32 °F to 302 °F, PTFE/AF100/EPDM, for steam

**Material** Body: stainless steel 1.4301 or 1.4571 (R70-02), optionally 1.4435  
Spring cage: stainless steel 1.4301 Diaphragm: EPDM  
Seals: EPDM, optionally PTFE O-rings: EPDM

**Mounting position** any

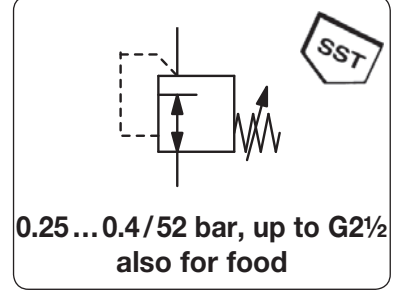

| Dimensions |   |   | Nominal size | K <sub>v</sub> -value | Flow rate   |               | Connection thread | Supply max. | Pressure range | Order number |
|------------|---|---|--------------|-----------------------|-------------|---------------|-------------------|-------------|----------------|--------------|
| A          | B | C | DN           | (m³/h)                | air l/min*1 | water l/min*2 | G                 | bar         | bar            |              |

| SST pressure regulator |     |    |    |      |     |    |      |    |              | supply max. 16 / 63 / 100 bar, non-relieving for compressed air, gas, water and steam*3 |         | R70 |
|------------------------|-----|----|----|------|-----|----|------|----|--------------|---|---------|-----|
| 58                     | 185 | 36 | 8  | 0.63 | 24  | 3  | G1/4 | 16 | 1.0 ... 1.7  | 1.7 ... 3.3   | R70-02A |     |
|                        |     |    |    |      |     |    |      |    | 2.8 ... 5.6  | 3.5 ... 6.2   | R70-02B |     |
|                        |     |    |    |      |     |    |      |    |              |   | R70-02C |     |
|                        |     |    |    |      |     |    |      |    |              |   | R70-02D |     |
| 70                     | 253 | 48 | 10 | 2.0  | 55  | 6  | G3/8 | *4 | 0.4 ... 0.9  | 0.8 ... 1.7   | R70-03A |     |
|                        |     |    |    |      |     |    |      |    | 1.5 ... 3.1  | 3.0 ... 6.1   | R70-03B |     |
|                        |     |    |    |      |     |    |      |    | 5.0 ... 9.8  | 7.0 ... 14.4  | R70-03C |     |
|                        |     |    |    |      |     |    |      |    |              |   | R70-03D |     |
|                        |     |    |    |      |     |    |      |    |              |   | R70-03E |     |
|                        |     |    |    |      |     |    |      |    |              |   | R70-03F |     |
| 90                     | 333 | 58 | 15 | 3.0  | 120 | 15 | G1/2 | *4 | 0.5 ... 0.94 | 1.0 ... 2.4   | R70-04A |     |
|                        |     |    |    |      |     |    |      |    | 2.6 ... 5.3  | 4.7 ... 9.5   | R70-04B |     |
|                        |     |    |    |      |     |    |      |    | 7.5 ... 15   | 13.0 ... 26   | R70-04C |     |
|                        |     |    |    |      |     |    |      |    | 26.0 ... 52  |   | R70-04D |     |
|                        |     |    |    |      |     |    |      |    |              |   | R70-04E |     |
|                        |     |    |    |      |     |    |      |    |              |   | R70-04F |     |
|                        |     |    |    |      |     |    |      |    |              |   | R70-04G |     |
| 90                     | 333 | 58 | 20 | 3.2  | 200 | 25 | G3/4 | *4 | 0.5 ... 0.94 | 1.0 ... 2.4   | R70-06A |     |
|                        |     |    |    |      |     |    |      |    | 2.6 ... 5.3  | 4.7 ... 9.5   | R70-06B |     |
|                        |     |    |    |      |     |    |      |    | 7.5 ... 15   | 13.0 ... 26   | R70-06C |     |
|                        |     |    |    |      |     |    |      |    | 26.0 ... 52  |   | R70-06D |     |
|                        |     |    |    |      |     |    |      |    |              |   | R70-06E |     |
|                        |     |    |    |      |     |    |      |    |              |   | R70-06F |     |
|                        |     |    |    |      |     |    |      |    |              |   | R70-06G |     |
| 105                    | 368 | 68 | 25 | 6.3  | 350 | 45 | G1   | *4 | 0.4 ... 0.8  | 1.0 ... 2.0   | R70-08A |     |
|                        |     |    |    |      |     |    |      |    | 1.7 ... 3.5  | 3.0 ... 6.1   | R70-08B |     |
|                        |     |    |    |      |     |    |      |    | 5.5 ... 11   | 12.0 ... 23   | R70-08C |     |
|                        |     |    |    |      |     |    |      |    |              |   | R70-08D |     |
|                        |     |    |    |      |     |    |      |    |              |   | R70-08E |     |
|                        |     |    |    |      |     |    |      |    |              |   | R70-08F |     |

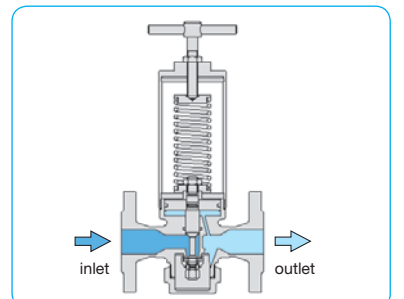
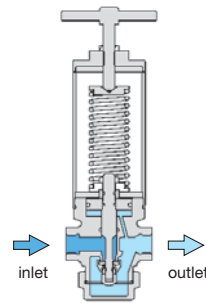
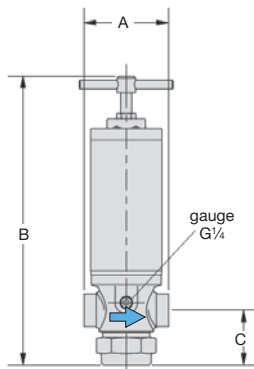
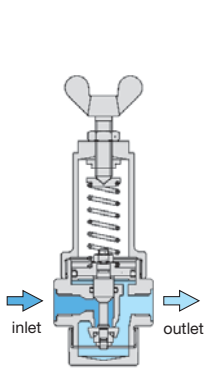

\*1 at flow velocity 10 m/s  
\*2 at 2.5 m/s

\*3 not for R70-02  
\*4 P<sub>1</sub> max. = P<sub>2</sub> max. + 25 bar

### Pharmacy and food-safe version

|                        |  |              |                           |                |   |
|------------------------|--|--------------|---------------------------|----------------|---|
| <b>Description</b>     | The pharmacy version (option <b>P</b> ) standard design is completely made of stainless steel, independent of inlet pressure, sealed at zero consumption, with EPDM and steamable up to 140 °C / 284 °F. Media contact parts have roughness of $R_a < 2.6 \mu\text{m}$ . |              |                           |                |   |
| <b>Special options</b> | Add the appropriate letter to the order number:  |              |                           |                |   |
| <b>Outer surface</b>   | Valve body: electropolished  | <b>FA</b>    | glass bead shot-peened    | <b>FC</b>      |   |
|                        | Complete valve: electropolished  | <b>FB</b>    | glass bead shot-peened    | <b>FD</b>      | ground/polished $R_a 1.2 \mu\text{m}$ <b>FE</b> |
| <b>Inner surface</b>   | Valve body: $R_a < 2.0 \mu\text{m}$  |              | glass bead shot-peened    | <b>GA</b>      |   |
|                        | Media contact parts: $R_a < 1.6 \mu\text{m}$   | <b>GB</b>    | $R_a < 0.8 \mu\text{m}$   | <b>GC</b>      | $R_a < 0.5 \mu\text{m}$ <b>GD</b>               |
| <b>Connection</b>      | Aseptic flange as per DIN 11864-2  | <b>F(AS)</b> | as per APV                | <b>F(APV)</b>  |   |
|                        | Flange as per DIN 2633 (PN16)  | <b>F</b>     | as per ANSI B16.5 150 lbs | <b>F150lbs</b> |   |
|                        | Threaded connection as per DIN 11851   | <b>GA</b>    |                           |                |   |
|                        | Clamp fittings as per DIN 32676  | <b>CL</b>    |                           |                |   |

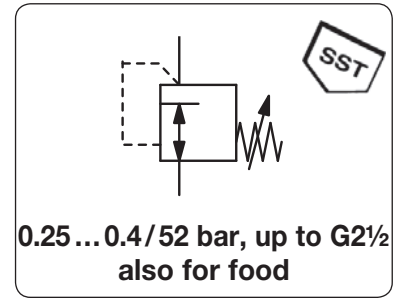

| Dimensions | Nominal size | $K_v$ -value | Flow rate air | Flow rate water | Connection thread | Supply max. bar | Pressure range bar | Order number |
|------------|--------------|--------------|---------------|-----------------|-------------------|-----------------|--------------------|--------------|
| A          | B            | C            | DN            | (m³/h)          |                   |                 |                    |              |
| mm         | mm           | mm           |               | l/min*1         | G                 | bar             | bar                |              |

| SST pressure regulator |     |     |    |      |      |     |     | supply pressure max. 40 / 63 bar, non-relieving, without constant bleed |              | R70            |  |
|------------------------|-----|-----|----|------|------|-----|-----|---|--------------|----------------|--|
| 145                    | 410 | 85  | 40 | 12.5 | 900  | 120 | G1½ | *4  | 1.0 ... 2.0  | <b>R70-12A</b> |  |
|                        |     |     |    |      |      |     |     |   | 1.6 ... 3.2  | <b>R70-12B</b> |  |
|                        |     |     |    |      |      |     |     |   | 2.4 ... 4.8  | <b>R70-12C</b> |  |
|                        |     |     |    |      |      |     |     |   | 4.8 ... 9.6  | <b>R70-12D</b> |  |
|                        |     |     |    |      |      |     |     |   | 9.5 ... 19   | <b>R70-12E</b> |  |
| 145                    | 410 | 85  | 50 | 13.0 | 1300 | 160 | G2  | *4  | 1.0 ... 2.0  | <b>R70-16A</b> |  |
|                        |     |     |    |      |      |     |     |   | 1.6 ... 3.2  | <b>R70-16B</b> |  |
|                        |     |     |    |      |      |     |     |   | 2.4 ... 4.8  | <b>R70-16C</b> |  |
|                        |     |     |    |      |      |     |     |   | 4.8 ... 9.6  | <b>R70-16D</b> |  |
|                        |     |     |    |      |      |     |     |   | 9.5 ... 19   | <b>R70-16E</b> |  |
| 220                    | 685 | 145 | 65 | 28.0 | 3200 | 420 | G2½ | *4  | 0.25 ... 0.4 | <b>R70-20A</b> |  |
|                        |     |     |    |      |      |     |     |   | 0.5 ... 1.1  | <b>R70-20B</b> |  |
|                        |     |     |    |      |      |     |     |   | 1.3 ... 2.6  | <b>R70-20C</b> |  |
|                        |     |     |    |      |      |     |     |   | 2.8 ... 5.6  | <b>R70-20D</b> |  |
|                        |     |     |    |      |      |     |     |   | 6.0 ... 12   | <b>R70-20E</b> |  |



| Special options, add the appropriate letter or number                     |  |                    |
|---|--|--------------------|
| <b>NPT</b>  | connection thread  | R70-... <b>N</b>   |
| <b>stainless steel 1.4435 up to 150 °C / 302 °F up to 200 °C / 392 °F</b> | housing 1.4435, spring cage 1.4301 for G¾ up to G1   | R70-... <b>S</b>   |
| <b>tamper-proof cap</b>   | PTFE seals   | R70-... <b>X55</b> |
| <b>drainage</b>   | PTFE / AF100 seals   | R70-... <b>X56</b> |
| <b>volume booster</b>   | adjustment by spanner, height 35 mm lower through bottom screw   | R70-... <b>T</b>   |
| <b>other connections</b>  | pneumatic pressure setting   | R70-... <b>U</b>   |
| <b>for pharmacy</b>   | DIN or ANSI flange, threaded connection or clamp fittings  | R70-... <b>J</b>   |
| <b>CIP cleaning</b>   | forged stainless steel, $R_a < 2.6 \mu\text{m}$ , steamable, EPDM pressure regulator sterilisable and minimal dead spots | R70-... <b>F.</b>  |
| <b>for food industry</b>  | EPDM elastomer with FDA approval   | R70-... <b>P</b>   |
|   |  | R70-... <b>R</b>   |

### Accessories, enclosed

|                       |   |                     |
|-----------------------|---|---------------------|
| <b>pressure gauge</b> | Ø 63 mm, 0...*3 bar, G¼ for other requirements on request | <b>MS6302-...*3</b> |
|-----------------------|---|---------------------|

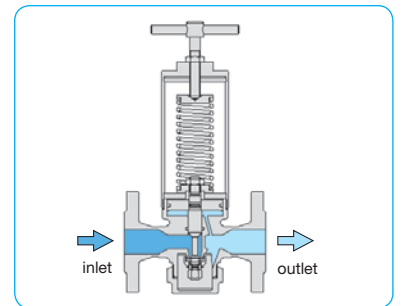

**tamper-proof cap for pressure adjustment**



**drainage through bottom screw**

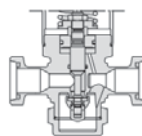

**threaded connection e.g. DIN 11851 / 11864-1**

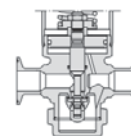

**clamp fittings e.g. DIN 32676**

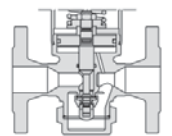

**flange e.g. DIN 11864-2**

\*1 at flow velocity 10 m/s  
\*2 at 2.5 m/s

\*3 02 = 0...2.5 bar, 04 = 0...4 bar, 06 = 0...6 bar, 10 = 0...10 bar, 16 = 0...16 bar, 25 = 0...25 bar, 60 = 0...60 bar  
\*4 P<sub>1</sub> max. = P<sub>2</sub> max. + 25 bar





# Low Pressure Regulator Made of Stainless Steel, Suitable for Pharmacy R74

|                           |   |                          |  |
|---------------------------|---|--------------------------|--|
| <b>Description</b>        | Diaphragm-operated pressure regulator completely made of stainless steel for very low outlet pressure, independent of inlet pressure.   |                          |  |
| <b>Note</b>               | It is recommended to select an outlet diameter at least one time larger than the main valve's diameter. Mounting position with spring cage downward at pressure range < 100 mbar. |                          |  |
| <b>Media</b>              | compressed air or gases   |                          |  |
| <b>Supply pressure</b>    | max. 25 bar at R74-02 to -A8,   | max. 16 bar at R74-08/16 |  |
| <b>Adjustment</b>         | by T-handle with locknut  |                          |  |
| <b>Relieving function</b> | non-relieving   |                          |  |
| <b>Gauge port</b>         | G $\frac{1}{4}$ on both sides of the body   | <b>Mounting position</b> | spring cage downward                                 |
| <b>Temperature range</b>  | 0 °C to 140 °C / 32 °F to 284 °F for EPDM, steamable  |                          |  |
| <b>Material</b>           | Body: stainless steel 1.4301, optionally 1.4435<br>Diaphragm: EPDM  | Seals: EPDM              | Spring cage: stainless steel 1.4301<br>O-rings: EPDM |

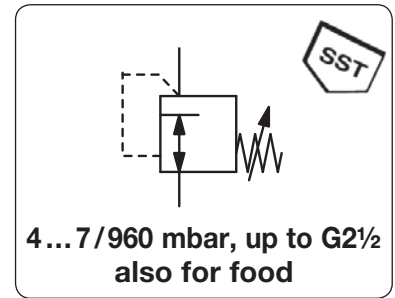

| Dimension | Nominal size | K <sub>v</sub> -value | Flow air | Flow water          | Connection thread | Diaphragm Ø mm | Supply pressure recomm. < bar | Pressure range mbar | Order number |
|-----------|--------------|-----------------------|----------|---------------------|-------------------|----------------|-------------------------------|---------------------|--------------|
| A         | B            | C                     | DN       | (m <sup>3</sup> /h) | G                 | Ø mm           |                               |                     |              |

| Low pressure regulator |     |    |    |     |     |     |                             |     |     | supply pressure max. 16 / 25 bar, non-relieving, without constant bleed |          | R74 |             |         |
|------------------------|-----|----|----|-----|-----|-----|-----------------------------|-----|-----|---|----------|-----|-------------|---------|
| 70                     | 368 | 48 | 8  | 1.2 | 30  | 1.8 | G $\frac{1}{4}$             | 405 | 0.5 | 4 ... 7   | R74-02A  | 0.5 | 6 ... 13    | R74-02B |
|                        |     |    |    |     |     |     |                             |     | 0.5 | 11 ... 22   | R74-02C  | 0.8 | 20 ... 40   | R74-02D |
|                        |     |    |    |     |     |     | R74-03 for G $\frac{3}{8}$  |     | 1.2 | 33 ... 65   | R74-02E  | 1.2 | 33 ... 65   | R74-02E |
|                        |     |    |    |     |     |     | R74-A4 for G $\frac{1}{2}$  | 310 | 1.5 | 40 ... 80   | R74-02F  | 2.0 | 60 ... 130  | R74-02G |
|                        |     |    |    |     |     |     |                             | 245 | 4.0 | 90 ... 180  | R74-02H  | 25  | 150 ... 300 | R74-02I |
|                        |     |    |    |     |     |     |                             | 190 | 25  | 300 ... 610   | R74-02K  | 25  | 500 ... 960 | R74-02L |
| 70                     | 368 | 48 | 10 | 2.0 | 30  | 1.8 | G $\frac{3}{8}$             | ... | ... | ...   | R74-03 . |     |             |         |
| 70                     | 368 | 48 | 15 | 2.2 | 30  | 1.8 | G $\frac{1}{2}$             | ... | ... | ...   | R74-A4 . |     |             |         |
| 90                     | 368 | 58 | 15 | 3.0 | 120 | 7.2 | G $\frac{1}{2}$             | 405 | 0.5 | 4 ... 7   | R74-04A  | 0.5 | 6 ... 12    | R74-04B |
|                        |     |    |    |     |     |     |                             |     | 0.5 | 11 ... 21   | R74-04C  | 0.8 | 19 ... 38   | R74-04D |
|                        |     |    |    |     |     |     | R74-06 for G $\frac{3}{4}$  |     | 1.2 | 30 ... 60   | R74-04E  | 1.2 | 30 ... 60   | R74-04E |
|                        |     |    |    |     |     |     | R74-A8 for G1               | 310 | 1.5 | 40 ... 77   | R74-04F  | 2.0 | 60 ... 127  | R74-04G |
|                        |     |    |    |     |     |     |                             | 245 | 4.0 | 90 ... 170  | R74-04H  | 25  | 150 ... 290 | R74-04I |
|                        |     |    |    |     |     |     |                             | 190 | 25  | 300 ... 590   | R74-04K  | 25  | 500 ... 920 | R74-04L |
| 90                     | 368 | 58 | 20 | 3.2 | 120 | 7.2 | G $\frac{3}{4}$             | ... | ... | ...   | R74-06 . |     |             |         |
| 90                     | 368 | 58 | 25 | 3.5 | 120 | 7.2 | G1                          | ... | ... | ...   | R74-A8 . |     |             |         |
| 105                    | 388 | 68 | 25 | 6.3 | 370 | 22  | G1                          | 405 | 0.5 | 4 ... 6   | R74-08A  | 0.5 | 5 ... 11    | R74-08B |
|                        |     |    |    |     |     |     |                             |     | 0.5 | 10 ... 20   | R74-08C  | 0.8 | 18 ... 35   | R74-08D |
|                        |     |    |    |     |     |     | R74-12 for G1 $\frac{1}{2}$ |     | 1.2 | 30 ... 58   | R74-08E  | 1.2 | 30 ... 58   | R74-08E |
|                        |     |    |    |     |     |     |                             | 310 | 1.4 | 35 ... 70   | R74-08F  | 2.0 | 60 ... 120  | R74-08G |
|                        |     |    |    |     |     |     |                             | 245 | 5.0 | 130 ... 260   | R74-08H  |     |             |         |

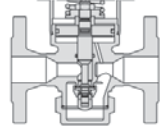
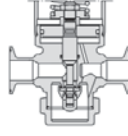
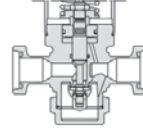
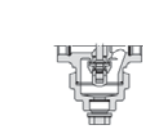
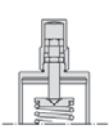

\*1 at 10 m/s flow velocity  
\*2 at 1.5 m/s flow velocity

# Low Pressure Regulator Made of Stainless Steel, Suitable for Pharmacy R74

## Pharmacy and food-safe version

|                        |  |              |                           |                |   |
|------------------------|--|--------------|---------------------------|----------------|---|
| <b>Description</b>     | The pharmacy version (option <b>P</b> ) standard design is completely made of stainless steel, independent of inlet pressure, sealed at zero consumption, with EPDM and steamable up to 140 °C / 284 °F. Media contact parts have roughness of $R_a < 2.6 \mu\text{m}$ . |              |                           |                |   |
| <b>Special options</b> | Add the appropriate letter to the order number:  |              |                           |                |   |
| <b>Outer surface</b>   | Valve body: electropolished  | <b>FA</b>    | glass bead shot-peened    | <b>FC</b>      |   |
|                        | Complete valve: electropolished  | <b>FB</b>    | glass bead shot-peened    | <b>FD</b>      | ground/polished $R_a 1.2 \mu\text{m}$ <b>FE</b> |
| <b>Inner surface</b>   | Valve body: $R_a < 2.0 \mu\text{m}$  |              | glass bead shot-peened    | <b>GA</b>      |   |
|                        | Media contact parts: $R_a < 1.6 \mu\text{m}$   | <b>GB</b>    | $R_a < 0.8 \mu\text{m}$   | <b>GC</b>      | $R_a < 0.5 \mu\text{m}$ <b>GD</b>               |
| <b>Connection</b>      | Aseptic flange as per DIN 11864-2  | <b>F(AS)</b> | as per APV                | <b>F(APV)</b>  |   |
|                        | Flange as per DIN 2633 (PN16)  | <b>F</b>     | as per ANSI B16.5 150 lbs | <b>F150lbs</b> |   |
|                        | Threaded connection as per DIN 11851   | <b>GA</b>    |                           |                |   |
|                        | Clamp fittings as per DIN 32676  | <b>CL</b>    |                           |                |   |

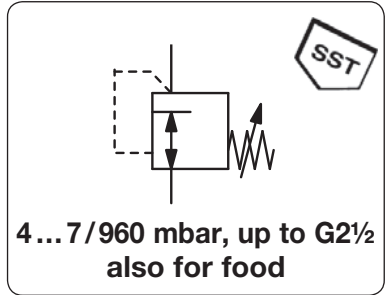

| Dimension | Nominal size | $K_v$ -value | Flow air | Flow water                | Connection thread            | Diaphragm $\varnothing$ mm   | Supply Pressure recomm. range | Order number     |       |      |        |
|-----------|--------------|--------------|----------|---------------------------|------------------------------|------------------------------|-------------------------------|------------------|-------|------|--------|
| A         | B            | C            | DN       | ( $\text{m}^3/\text{h}$ ) | ( $\text{l}/\text{min}^*1$ ) | ( $\text{l}/\text{min}^*2$ ) | G                             | $\varnothing$ mm | < bar | mbar | number |

| Low pressure regulator |     |    |    |      |      |    |     |     |     | supply pressure max. 16 / 25 bar, non-relieving, without constant bleed |  | R74 |         |
|------------------------|-----|----|----|------|------|----|-----|-----|-----|---|--|-----|---------|
| 145                    | 435 | 85 | 50 | 13.0 | 1350 | 81 | G2* | 405 | 0.5 | 4 ... 6   |  |     | R74-16A |
|                        |     |    |    |      |      |    |     |     | 0.5 | 5 ... 11  |  |     | R74-16B |
|                        |     |    |    |      |      |    |     |     | 0.5 | 10 ... 19   |  |     | R74-16C |
|                        |     |    |    |      |      |    |     |     | 0.8 | 17 ... 33   |  |     | R74-16D |
|                        |     |    |    |      |      |    |     |     | 1.2 | 27 ... 54   |  |     | R74-16E |
|                        |     |    |    |      |      |    |     | 310 | 2.0 | 60 ... 110  |  |     | R74-16F |
|                        |     |    |    |      |      |    |     |     | 3.0 | 80 ... 170  |  |     | R74-16G |
|                        |     |    |    |      |      |    |     | 245 | 4.0 | 120 ... 250   |  |     | R74-16H |
|                        |     |    |    |      |      |    |     |     | 16  | 190 ... 380   |  |     | R74-16I |
|                        |     |    |    |      |      |    |     | 190 | 16  | 250 ... 500   |  |     | R74-16K |
|                        |     |    |    |      |      |    |     |     | 16  | 400 ... 790   |  |     | R74-16L |
| 145                    | 435 | 85 | 40 | 12.5 | 1350 | 81 | G1½ | ... | ... | ...   |  |     | R74-B2. |
| 145                    | 435 | 85 | 65 | 13.5 | 1350 | 81 | G2½ | ... | ... | ...   |  |     | R74-20. |



R74-08IF



R74-16A

## Special options, add the appropriate letter

|                               |   |           |
|-------------------------------|---|-----------|
| <b>NPT</b>                    | connection thread   | R74-...N  |
| <b>stainless steel 1.4435</b> | housing 1.4435, spring cage 1.4301 for G $\frac{3}{8}$ up to G1   | R74-...S  |
| <b>tamper-proof cap</b>       | adjustment by spanner, height 40 mm lower                         | R74-...T  |
| <b>drainage</b>               | through bottom screw  | R74-...U  |
| <b>volume booster</b>         | pneumatic pressure setting  | R74-...J  |
| <b>other connections</b>      | DIN or ANSI flange, threaded connection or clamp fittings         | R74-...F. |
| <b>for pharmacy</b>           | forged stainless steel, $R_a < 2.6 \mu\text{m}$ , steamable, EPDM | R74-...P  |
| <b>CIP cleaning</b>           | pressure regulator sterilisable and minimal dead spots            | R74-...   |
| <b>for food industry</b>      | EPDM elastomer with FDA approval                                  | R74-...   |

## Accessories, enclosed

**pressure gauge**  $\varnothing 63 \text{ mm}$ , 0...<sup>\*3</sup> bar, G $\frac{1}{4}$ , capsule type, 0...100 °C / 32...212 °F **MS6302-..**<sup>\*3</sup>  
for other requirements on request

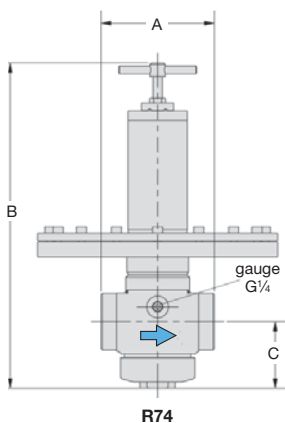

R74

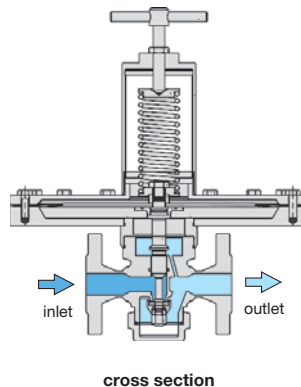

cross section

\*1 at 10 m/s flow velocity

\*2 at 1.5 m/s flow velocity

\*3 B2 = 0...25 mbar, B6 = 0...60 mbar, C1 = 0...100 mbar, C3 = 0...250 mbar, C4 = 0...400 mbar, C6 = 0...600 mbar

Gauges: see chapter for measuring devices

PDF CAD  
www.aircom.net



Order example:  
R74-16A

# Filter Regulator Made of Stainless Steel Throughout, up to 50 bar B3000

|                           |   |   |
|---------------------------|---|---|
| <b>Description</b>        | Filter pressure regulator with bowl without sight glass completely made of stainless steel. Application examples are the chemistry, petroleum processing as well as food industry and medical technology. |   |
| <b>Media</b>              | compressed air, gases or liquids  |   |
| <b>Supply pressure</b>    | max. 50 bar (without drain)   |   |
| <b>Adjustment</b>         | by hexagon socket crew with locknut   |   |
| <b>Relieving function</b> | relieving, optionally non-relieving   |   |
| <b>Gauge port</b>         | G $\frac{1}{4}$ on both sides of the body, G $\frac{1}{2}$ at B3000-01, one screw plug supplied   |   |
| <b>Filter element</b>     | 50 $\mu$ m, optionally 5 $\mu$ m, made of stainless steel <b>Bowl</b> stainless steel version without sight glass   |   |
| <b>Drain</b>              | screw plug as standard, manual drain (max. 30 bar) as standard for B3000-01H and B3000-A2H, optionally for G $\frac{1}{4}$ (02) to G1 or automatic drain (max. 16 bar)                                    |   |
| <b>Temperature range</b>  | -20 °C to 60 °C / - 4 °F to 140 °F for NBR/Buna-N, EPDM or FKM<br>-20 °C to 130 °C / - 4 °F to 266 °F for high temperature version<br>down to -40 °C / -40 °F for stainless steel diaphragm               |   |
| <b>Material</b>           | Body: stainless steel 316L, material no. 1.4404   | O-rings: FKM, optionally EPDM<br>Diaphragm: NBR/Buna-N with PTFE coating, |

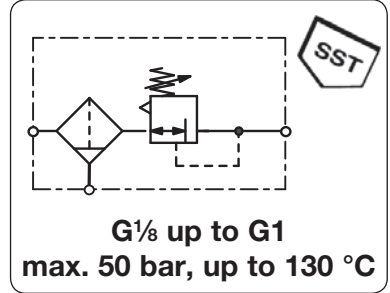

| Dimensions |   |   | Bowl capacity | Regulating system<br>D = Diaphragm<br>P = Piston | Flow rate   |         | Connection thread | Order number |
|------------|---|---|---------------|--|-------------|---------|-------------------|--------------|
| A          | B | C |               |  | m $^3$ /h*1 | l/min*1 |                   |              |

| Filter pressure regulator |     |     |      |   |     |      |                 |                  |
|---------------------------|-----|-----|------|---|-----|------|-----------------|------------------|
| 40                        | 150 | 80  | 0.03 | D | 36  | 600  | G $\frac{1}{8}$ | <b>B3000-01H</b> |
| 64                        | 240 | 125 | 0.17 | D | 84  | 1400 | G $\frac{1}{4}$ | <b>B3000-A2H</b> |
| 79                        | 250 | 130 | 0.28 | D | 230 | 3800 | G $\frac{1}{2}$ | <b>B3000-02</b>  |
| 89                        | 307 | 165 | 0.58 | P | 360 | 6000 | G $\frac{3}{4}$ | <b>B3000-03</b>  |
|                           |     |     |      |   |     |      | G1              | <b>B3000-04</b>  |
|                           |     |     |      |   |     |      |                 | <b>B3000-A6</b>  |
|                           |     |     |      |   |     |      |                 | <b>B3000-06</b>  |
|                           |     |     |      |   |     |      |                 | <b>B3000-08</b>  |



## Special options, add the appropriate letter or number

|   |  |  |             |
|---|--|--|-------------|
| <b>5 <math>\mu</math>m filter element</b> | for G $\frac{1}{4}$ (02) to G $\frac{3}{4}$ (A6) | for G $\frac{3}{4}$ (06) and G1                  | B3000-..G   |
| <b>NPT connection thread</b>              |  |  | B3000-..N   |
| <b>0.2... 3 bar pressure range</b>        |  |  | B3000-..B   |
| <b>1 ...15 bar pressure range</b>         |  |  | B3000-..D   |
| <b>manual drain</b>                       | max. 30 bar                                      | for G $\frac{1}{4}$ (02) to G1                   | B3000-..H   |
| <b>automatic drain</b>                    | max. 16 bar                                      | for G $\frac{1}{4}$ (02) to G1                   | B3000-..R   |
| <b>non-relieving</b>                      | without relieving function                       |  | B3000-..K   |
| <b>up to -40 °C / -40 °F</b>              | low temperature version                          | from G $\frac{1}{4}$ (02) on                     | B3000-..X51 |
| <b>up to 130 °C / 266 °F</b>              | high temperature version                         |  | B3000-..X54 |
| <b>EPDM elastomer</b>                     |  |  | B3000-..E   |
| <b>SST diaphragm</b>                      | not for water                                    | for G $\frac{1}{4}$ (02) to G $\frac{3}{4}$ (A6) | B3000-..S   |
| <b>nitrogen N<math>_2</math>: 07</b>      | <b>ammonia NH<math>_3</math>: 02</b>             | <b>carbon dioxide CO<math>_2</math>:</b>         | B3000-..03  |
| <b>argon Ar: 05</b>                       | <b>helium He: 09</b>                             | <b>hydrogen H<math>_2</math>:</b>                | B3000-..11  |
| <b>methane CH<math>_4</math>: 13</b>      | <b>oxygen O<math>_2</math>: 15</b>               | <b>propane C<math>_3</math>H<math>_8</math>:</b> | B3000-..16  |
|   |  | <b>nitrous oxide N<math>_2</math>O:</b>          | B3000-..17  |
| <b>flange connection</b>                  | see end of the chapter / flanges                 |  | B3000-..F   |
| <b>FDA material</b>                       | stainless steel diaphragm, o-rings EPDM          | for G $\frac{1}{4}$                              | B3000-..    |



## Accessories, enclosed

|                         |  |  |                                    |
|-------------------------|--|--|------------------------------------|
| <b>pressure gauge</b>   | $\varnothing$ 40 mm, 0... $^{*2}$ bar, G $\frac{1}{8}$ | for G $\frac{1}{8}$ and G $\frac{1}{4}$ (A2)     | <b>MS4001-..<math>^{*2}</math></b> |
|                         | $\varnothing$ 50 mm, 0... $^{*2}$ bar, G $\frac{1}{4}$ | for G $\frac{1}{4}$ to G $\frac{3}{4}$ (A6)      | <b>MS5002-..<math>^{*2}</math></b> |
|                         | $\varnothing$ 63 mm, 0... $^{*2}$ bar, G $\frac{1}{2}$ | for G $\frac{3}{4}$ and G1                       | <b>MS6302-..<math>^{*2}</math></b> |
| <b>mounting bracket</b> |  | for G $\frac{1}{8}$ and G $\frac{1}{4}$ (A2)     | <b>BW30-03S</b>                    |
| <b>mounting nut</b>     |  |  | <b>M30x1,5S</b>                    |
| <b>mounting bracket</b> |  | for G $\frac{1}{4}$ (02) to G $\frac{3}{8}$ (03) | <b>BW45-03S</b>                    |
| <b>mounting nut</b>     |  |  | <b>M45x1,5S</b>                    |
| <b>mounting bracket</b> |  | for G $\frac{1}{2}$ (04) to G1                   | <b>BW50-01S</b>                    |
| <b>mounting nut</b>     |  |  | <b>M50x1,5S</b>                    |

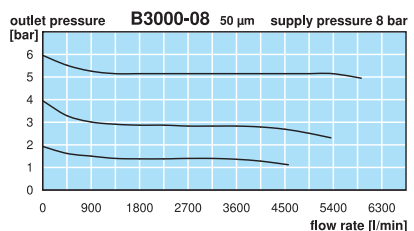
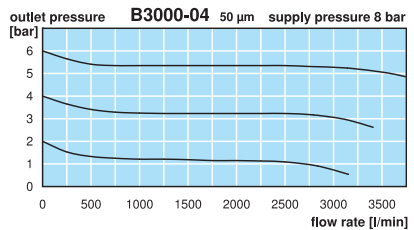
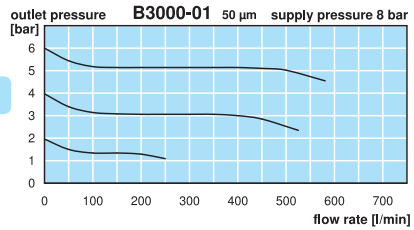
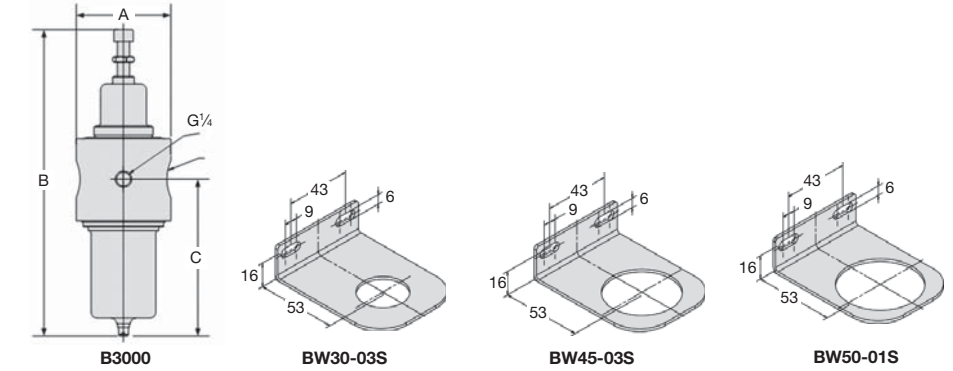

\*1 at 8 bar supply pressure, 6 bar outlet pressure and 1 bar pressure \*2 04 = 0...4 bar, 10 = 0...10 bar, 16 = 0...16 bar \*3 from G $\frac{1}{4}$  (02) on

Extensions: see chapter for FRL service units  
 Gauges: see chapter for measuring devices  
 Spare parts: see separate spare parts list

**PDF CAD**  
www.aircom.net

**Order example:**  
**B3000-01H**

|                           |  |
|---------------------------|--|
| <b>Description</b>        | Regulator of small, compact design, ideal for limited space conditions. Application examples are the chemistry, petroleum processing as well as food industry and medical technology.  |
| <b>Media</b>              | compressed air, gases or liquids   |
| <b>Supply pressure</b>    | max. 21 bar  |
| <b>Adjustment</b>         | by plastic knob with snap-lock, optionally by T-handle at B558   |
| <b>Relieving function</b> | relieving, optionally non-relieving  |
| <b>Gauge port</b>         | G $\frac{1}{4}$ on both sides of the body, screw plugs supplied  |
| <b>Filter element</b>     | 20 $\mu$ m at B548, 40 $\mu$ m at B11, made of polypropylene   |
| <b>Bowl</b>               | stainless steel version without sight glass  |
| <b>Drainage</b>           | manual drain as standard for max. 21 bar, optionally automatic drain for max. 12 bar   |
| <b>Temperature range</b>  | 0 °C to 80 °C / 32 °F to 176 °F, max. 50 °C / 122 °F at automatic drain version  |
| <b>Material</b>           | Body: stainless steel 316, material no. 1.4401<br>Spring cage: glass fibre-reinforced plastic at B11 and B548, stainless steel 316 / 1.4401 at B558<br>Elastomer: FKM<br>Inner valve: stainless steel 316, material no. 1.4401 |

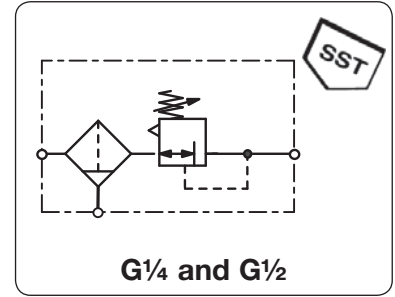

| Dimensions |    |    | Bowl capacity<br>l | Flow rate<br>m $^3$ /h*1<br>l/min*1 | Supply Connection<br>max. thread<br>bar | Pressure range<br>bar | Order number |
|------------|----|----|--------------------|-------------------------------------|---|-----------------------|--------------|
| A          | B  | C  |                    |                                     |   |                       |              |
| mm         | mm | mm |                    |                                     | G                                       |                       |              |

| Miniature filter pressure regulator |     |    |      |    |     |    | manual drain, relieving,<br>w/o gauge, 20 $\mu$ m filter element | B548-S    |             |
|-------------------------------------|-----|----|------|----|-----|----|--|-----------|-------------|
| 40                                  | 156 | 95 | 0.04 | 27 | 450 | 21 | G $\frac{1}{4}$  | 0.2...1.8 | B548-02DHAS |
|                                     |     |    |      |    |     |    |  | 0.2...4.0 | B548-02DHBS |
|                                     |     |    |      |    |     |    |  | 0.3...9.0 | B548-02DHCS |



B548, accessory: gauge

| "Midi" filter pressure regulator |     |     |      |     |      |    | manual drain, relieving,<br>w/o gauge, 40 $\mu$ m filter element | B11-S     |             |
|----------------------------------|-----|-----|------|-----|------|----|--|-----------|-------------|
| 62                               | 216 | 125 | 0.12 | 138 | 2300 | 21 | G $\frac{1}{2}$  | 0.2...1.8 | B11 -04DJAS |
|                                  |     |     |      |     |      |    |  | 0.2...4.0 | B11 -04DJBS |
|                                  |     |     |      |     |      |    |  | 0.3...9.0 | B11 -04DJCS |
|                                  |     |     |      |     |      |    |  | 0.5...17  | B11 -04DJDS |



stainless steel  
**SST**  
15

### Special options, add the appropriate letter

|                          |                                    |                      |
|--------------------------|------------------------------------|----------------------|
| 5 $\mu$ m filter element |                                    | B ... -0... G...     |
| NPT                      | connection thread                  | B ... -0... N        |
| automatic drain          | made of SST, SA10MDSS, max. 12 bar | for B11 B11 -04... R |
| non-relieving            | without relieving function         | B ... -0... K        |
| SST spring cage          |                                    | for B548 B558-02D... |

### Accessories, enclosed

|                  |  |          |             |
|------------------|--|----------|-------------|
| pressure gauge   | $\varnothing$ 40 mm, 0...*2 bar, G $\frac{1}{4}$ | for B548 | MS4002-..*2 |
|                  | $\varnothing$ 50 mm, 0...*2 bar, G $\frac{1}{4}$ | for B11  | MS5002-..*2 |
| mounting bracket |  | for B548 | BW30-03S    |
| mounting nut     |  | for B548 | M30x1,5S    |
| mounting bracket |  | for B11  | BW45-03S    |
| mounting nut     |  | for B11  | M45x1,5S    |

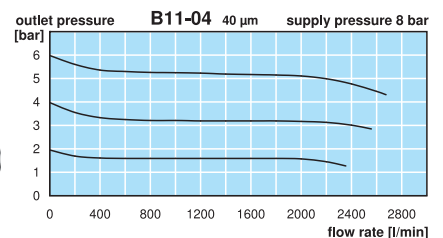
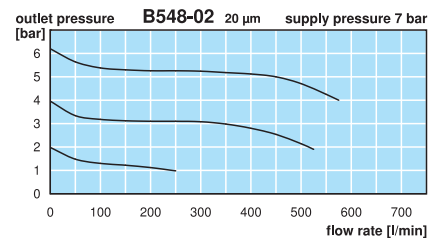
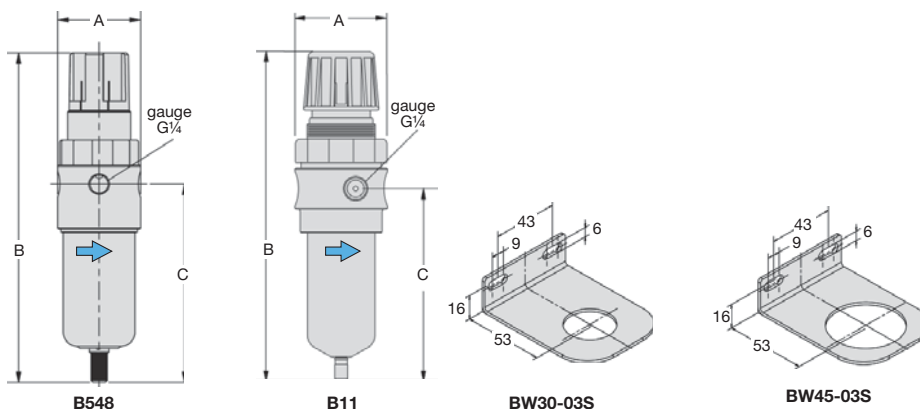

\*1 at 7 bar supply pressure, 6 bar outlet pressure and 1 bar pressure drop      \*2 04 = 0...4 bar, 10 = 0...10 bar, 16 = 0...16 bar

Extensions: see chapter for FRL service units  
Gauges: see chapter for measuring devices  
Spare parts: see separate spare parts list

PDF CAD  
www.aircom.net

**Order example:**  
B548-02DHAS



|                           |  |
|---------------------------|--|
| <b>Description</b>        | Lubricator for compressed air with bowl without sight glass, extremely robust, with manual adjustment of oil drip rate.  |
| <b>Bowl</b>               | stainless steel version without sight glass  |
| <b>Operating pressure</b> | max. 50 bar  |
| <b>Temperature range</b>  | 0 °C to 80 °C / 32 °F to 176 °F for NBR/Buna-N,<br>0 °C to 130 °C / 32 °F to 266 °F for high temperature version<br>for appropriately conditioned air down to -20 °C / -4 °F, or<br>low temperature version down to -40°C / -40 °F |
| <b>Material</b>           | Body: stainless steel 316L, material no. 1.4404<br>Bowl: stainless steel 316L, material no. 1.4404<br>Elastomer: FKM<br>Inner valve: stainless steel 316L, material no. 1.4404   |

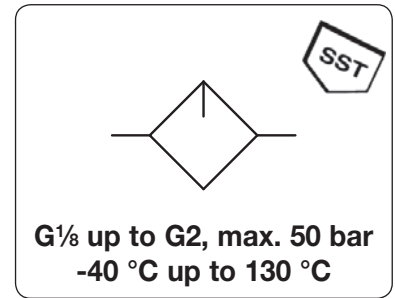

| Dimensions |   |   | Bowl capacity<br>l | Flow rate |         | Operating pressure<br>max. bar | Connection thread<br>G | Order number |
|------------|---|---|--------------------|-----------|---------|--------------------------------|------------------------|--------------|
| A          | B | C |                    | m³/h*1    | l/min*1 |                                |                        |              |

| Lubricator |     |     | operating pressure max. 50 bar |     |       |    |        | L3000    |  |
|------------|-----|-----|--------------------------------|-----|-------|----|--------|----------|--|
| 40         | 124 | 80  | 0.04                           | 45  | 750   | 50 | G1/8   | L3000-01 |  |
| 64         | 173 | 129 | 0.15                           | 54  | 900   | 50 | G1/4   | L3000-02 |  |
|            |     |     |                                | 60  | 1000  |    | G3/8   | L3000-03 |  |
| 79         | 175 | 130 | 0.21                           | 144 | 2400  | 50 | G1/2   | L3000-04 |  |
|            |     |     |                                | 150 | 2500  |    | G3/4   | L3000-A6 |  |
| 89         | 206 | 168 | 0.58                           | 480 | 8000  | 50 | G3/4   | L3000-06 |  |
|            |     |     |                                | 492 | 8200  |    | G1     | L3000-08 |  |
| 168        | 279 | 224 | 1.50                           | 720 | 12000 | 50 | G1 1/2 | L3000-12 |  |
|            |     |     |                                | 780 | 13000 |    | G2     | L3000-16 |  |



L3000-01



L3000-02

### Special options, add the appropriate letter or number

|                              |                                  |              |
|------------------------------|----------------------------------|--------------|
| <b>NPT</b>                   | connection thread                | L3000-.. N   |
| <b>up to -40 °C / -40 °F</b> | low temperature version          | L3000-.. X51 |
| <b>up to 130 °C / 266 °F</b> | high temperature version         | L3000-.. X54 |
| <b>flange connection</b>     | see end of the chapter / flanges | L3000-.. F.  |

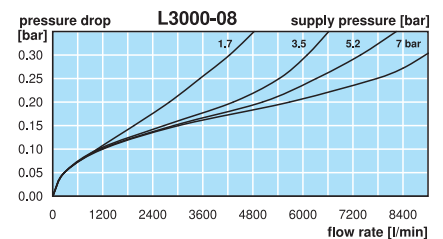
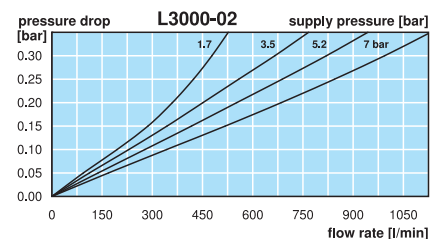
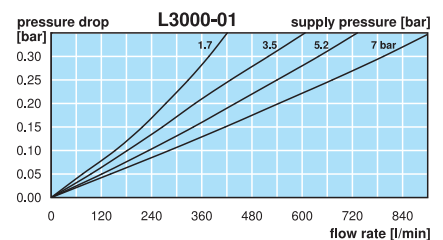
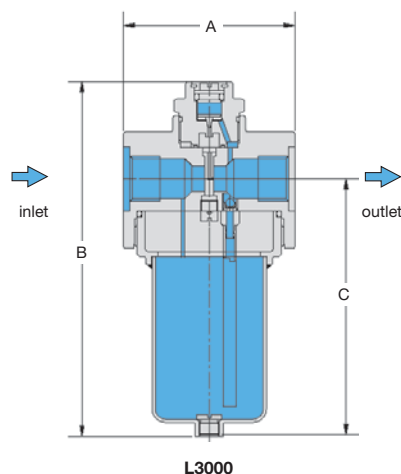

\*1 at 7 bar operating pressure and 0.33 bar pressure drop

Extensions: see chapter for FRL service units

PDF CAD  
www.aircom.net



Order example:  
L3000-01

# Filter Made of Stainless Steel Throughout, up to 50 bar

**F3000**

|                           |   |
|---------------------------|---|
| <b>Description</b>        | Filter with bowl without sight glass completely made of stainless steel, extremely robust, suitable for compressed air, gases or liquids. Application examples are the chemistry, petroleum processing as well as food industry and medical technology. |
| <b>Filter element</b>     | 50 µm, optionally 5 µm, made of stainless steel   |
| <b>Bowl</b>               | stainless steel version without sight glass   |
| <b>Drainage</b>           | screw plug as standard, optionally manual drain (max. 30 bar) or automatic drain (max. 16 bar)  |
| <b>Operating pressure</b> | max. 50 bar (without drain)   |
| <b>Temperature range</b>  | 0 °C to 80 °C / 32 °F to 176 °F for FKM or EPDM<br>0 °C to 130 °C / 32 °F to 266 °F for high temperature version,<br>for appropriately conditioned compressed air down to -20 °C / -4 °F, or<br>low temperature version down to -40 °C / -40 °F         |
| <b>Material</b>           | Body: stainless steel 316L, material no. 1.4404<br>Bowl: stainless steel 316L, material no. 1.4404<br>Elastomer: FKM, optionally EPDM<br>Inner valve: stainless steel 316L, material no. 1.4404   |

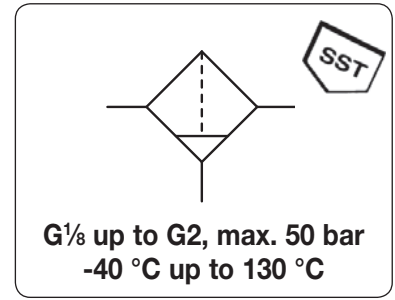

| Dimensions |    |    | Bowl capacity | Flow rate           | Operating pressure | filter element | Connection thread | Order number |
|------------|----|----|---------------|---------------------|--------------------|----------------|-------------------|--------------|
| A          | B  | C  |               |                     |                    |                |                   |              |
| mm         | mm | mm | l             | m <sup>3</sup> /h*1 | l/min*1            | bar            | µm                | G            |

| Stainless steel filter, up to 50 bar |     |     |      |     |        |    |    | with screw plug, 50 µm        | F3000           |
|--------------------------------------|-----|-----|------|-----|--------|----|----|-------------------------------|-----------------|
| 40                                   | 92  | 80  | 0.04 | 45  | 750    | 50 | 50 | G <sup>1</sup> / <sub>8</sub> | <b>F3000-01</b> |
|                                      |     |     |      | 45  | 750    |    |    | G <sup>1</sup> / <sub>4</sub> | <b>F3000-A2</b> |
| 64                                   | 139 | 125 | 0.15 | 54  | 900    | 50 | 50 | G <sup>1</sup> / <sub>4</sub> | <b>F3000-02</b> |
|                                      |     |     |      | 60  | 1 000  |    |    | G <sup>3</sup> / <sub>8</sub> | <b>F3000-03</b> |
| 79                                   | 150 | 130 | 0.28 | 150 | 2 500  | 50 | 50 | G <sup>1</sup> / <sub>2</sub> | <b>F3000-04</b> |
|                                      |     |     |      | 162 | 2 700  |    |    | G <sup>3</sup> / <sub>4</sub> | <b>F3000-A6</b> |
| 89                                   | 191 | 165 | 0.58 | 432 | 7 200  | 50 | 50 | G <sup>3</sup> / <sub>4</sub> | <b>F3000-06</b> |
|                                      |     |     |      | 432 | 7 200  |    |    | G <sub>1</sub>                | <b>F3000-08</b> |
| 180                                  | 298 | 216 | 1.00 | 900 | 15 000 | 50 | 50 | G <sup>1</sup> / <sub>2</sub> | <b>F3000-12</b> |
|                                      |     |     |      | 960 | 16 000 |    |    | G <sub>2</sub>                | <b>F3000-16</b> |



## Special options, add the appropriate letter or number

|   |                                  |                                   |  |   |             |
|---|----------------------------------|-----------------------------------|--|---|-------------|
| <b>5 µm filter element</b>                            |                                  |                                   |  | for G <sup>1</sup> / <sub>4</sub> (02) and G <sup>3</sup> / <sub>4</sub> (A6) | F3000-..G   |
|   |                                  |                                   |  | for G <sup>3</sup> / <sub>4</sub> and G <sub>1</sub>                          | F3000-..G   |
|   |                                  |                                   |  | for G <sup>1</sup> / <sub>2</sub> and G <sub>2</sub>                          | F3000-..G   |
| <b>NPT connection thread</b>                          |                                  |                                   |  |   | F3000-..N   |
| <b>up to -40 °C / -40 °F low temperature version</b>  |                                  |                                   |  | from G <sup>1</sup> / <sub>4</sub> (02) on                                    | F3000-..X51 |
| <b>up to 130 °C / 266 °F high temperature version</b> |                                  |                                   |  | from G <sup>1</sup> / <sub>4</sub> (02) on                                    | R3000-..X54 |
| <b>manual drain max. 30 bar</b>                       |                                  |                                   |  |   | F3000-..H   |
| <b>automatic drain max. 16 bar</b>                    |                                  |                                   |  | for G <sup>1</sup> / <sub>4</sub> (02) to G <sub>2</sub>                      | F3000-..R   |
| <b>EPDM elastomer</b>                                 |                                  |                                   |  |   | F3000-..E   |
| <b>nitrogen N<sub>2</sub>: 07</b>                     |                                  | <b>ammonia NH<sub>3</sub>: 02</b> |  | <b>carbon dioxide CO<sub>2</sub>: F3000-...03</b>                             |             |
| <b>argon Ar: 05</b>                                   |                                  | <b>helium He: 09</b>              |  | <b>hydrogen H<sub>2</sub>: F3000-...11</b>                                    |             |
| <b>methane CH<sub>4</sub>: 13</b>                     |                                  | <b>oxygen O<sub>2</sub>: 15</b>   |  | <b>propane C<sub>3</sub>H<sub>8</sub>: F3000-...16</b>                        |             |
| <b>nitrous oxide N<sub>2</sub>O: 17</b>               |                                  |                                   |  | <b>water H<sub>2</sub>O: F3000-...W</b>                                       |             |
| <b>flange connection</b>                              | see end of the chapter / flanges |                                   |  |   | F3000-...F. |



## Accessories, enclosed

|                         |  |                 |
|-------------------------|--|-----------------|
| <b>mounting bracket</b> | for G <sup>1</sup> / <sub>4</sub> (02) and G <sup>3</sup> / <sub>8</sub> | <b>BW00-17S</b> |
|                         | for G <sup>1</sup> / <sub>2</sub> and G <sup>3</sup> / <sub>4</sub> (A6) | <b>BW00-18S</b> |
|                         | for G <sup>3</sup> / <sub>4</sub> (06) and G <sub>1</sub>                | <b>BW00-19S</b> |

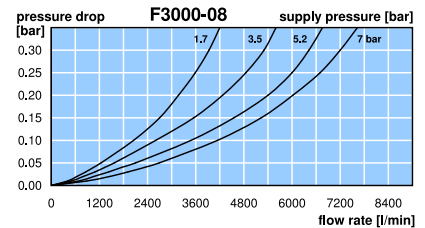
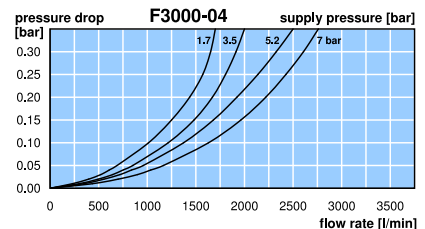
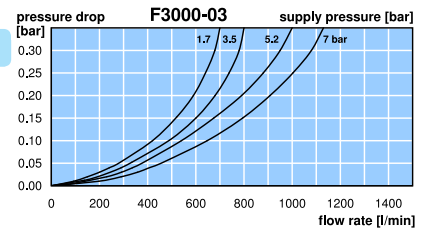
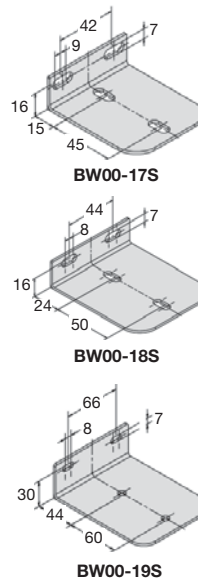
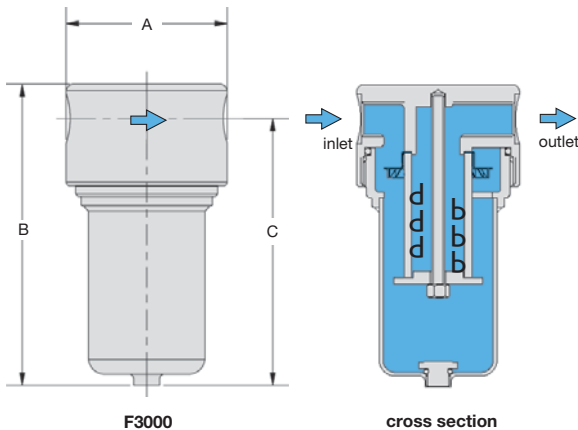

\*1 at 7 bar operating pressure and 0.33 bar pressure drop

**Extensions:** see chapter for FRL service units  
**Spare parts:** see separate spare parts list

**PDF CAD**  
www.aircom.net

**Order example:**  
F3000-01

# Druckluft-Wartungseinheiten komplett aus Edelstahl, bis 50 bar C3000

|                           |   |
|---------------------------|---|
| <b>Description</b>        | FRL service unit completely made of stainless steel. Application examples are the chemistry, petroleum processing as well as food industry and medical technology.                                    |
| <b>Media</b>              | compressed air, gases or liquids  |
| <b>Supply pressure</b>    | max. 50 bar at C3002, max. 30 bar at C3003, optionally max. 50 bar (all without drain)  |
| <b>Adjustment</b>         | by hexagon socket screw with locknut  |
| <b>Relieving function</b> | relieving, optionally non-relieving   |
| <b>Gauge port</b>         | G $\frac{1}{4}$ on both sides of the body, G $\frac{1}{2}$ at C3002-01, one screw plug supplied   |
| <b>Filter element</b>     | 50 $\mu$ m, optionally 5 $\mu$ m, made of stainless steel   |
| <b>Bowl</b>               | stainless steel version without sight glass   |
| <b>Drainage</b>           | screw plug as standard, optionally manual drain (max. 30 bar) or automatic drain (max. 16 bar)  |
| <b>Temperature range</b>  | -20 °C to 60 °C / -4 °F to 140 °F for NBR/Buna-N, EPDM or FKM<br>-20 °C to 130 °C / -4 °F to 266 °F for high temperature version, or low temperature version down to -40 °C / -40 °F                  |
| <b>Material</b>           | Body / Bowl: stainless steel 316L, material no. 1.4404<br>Inner valve: stainless steel 316L / 1.4404<br>Diaphragm: NBR/Buna-N with PTFE coating, optionally EPDM or FKM O-rings: FKM, optionally EPDM |

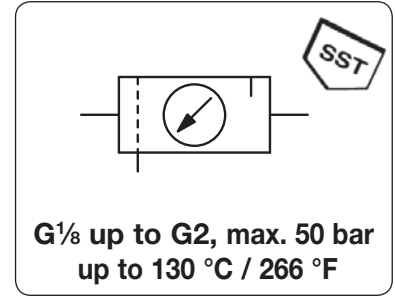

| Dimensions |    |    | FRL           | Flow                | Connection | Order  |
|------------|----|----|---------------|---------------------|------------|--------|
| A          | B  | C  | service unit  | rate                | thread     | number |
| mm         | mm | mm | consisting of | m <sup>3</sup> /h*1 | G          |        |

| FRL unit, 2-part |     |     | supply: max. 50 bar, outlet: 0.5...8 bar, 50 $\mu$ m, screw plug, relieving, with pressure gauge |     |      | C3002                    |
|------------------|-----|-----|--|-----|------|--------------------------|
| 90               | 150 | 80  | B+L3000  | 33  | 550  | G $\frac{1}{8}$ C3002-01 |
| 138              | 240 | 125 |  | 51  | 850  | G $\frac{1}{4}$ C3002-02 |
| 138              | 240 | 125 |  | 57  | 950  | G $\frac{3}{8}$ C3002-03 |
| 168              | 250 | 130 |  | 138 | 2300 | G $\frac{1}{2}$ C3002-04 |
| 188              | 307 | 165 |  | 342 | 5700 | G $\frac{3}{4}$ C3002-06 |
| 188              | 307 | 165 |  | 350 | 6000 | G1 C3002-08              |



| FRL unit, 3-part |     |     | supply: max. 50 bar, outlet: 0.5...8 bar, 50 $\mu$ m, screw plug, relieving, with pressure gauge |     |       | C3003                     |
|------------------|-----|-----|--|-----|-------|---------------------------|
| 212              | 167 | 129 | F+R+L3000  | 51  | 850   | G $\frac{1}{4}$ C3003-02  |
| 257              | 171 | 136 |  | 138 | 2300  | G $\frac{1}{2}$ C3003-04  |
| 324              | 283 | 217 |  | 342 | 5700  | G $\frac{3}{4}$ C3003-06  |
| 324              | 283 | 217 |  | 350 | 6000  | G1 C3003-08               |
| 539              | 385 | 257 |  | 720 | 12000 | G1 $\frac{1}{2}$ C3003-12 |
| 539              | 385 | 257 |  | 780 | 13000 | G2 C3003-B6               |



## Special options, add the appropriate letter or number

|                              |                                  |  |   |
|------------------------------|----------------------------------|--|---|
| 5 $\mu$ m filter element     |                                  | for G $\frac{1}{4}$ and G $\frac{3}{4}$<br>for G1<br>for G1 $\frac{1}{2}$ and G2 | C300...G<br>C300...G<br>C300...G<br>C300...N<br>C300...B<br>C300...D<br>C300...H<br>C300...R<br>C300...X51<br>C300...X54<br>C300...E<br>C300...F. |
| NPT connection thread        |                                  |  |   |
| 0.2 ... 3 bar pressure range |                                  |  |   |
| 1.0 ...15 bar pressure range | P <sub>1</sub> max. 50 bar       |  |   |
| manual drain                 | max. 30 bar                      |  |   |
| automatic drain              | max. 16 bar                      | for G $\frac{1}{4}$ up to G2   |   |
| up to -40 °C / -40 °F        | low temperature version          |  |   |
| up to 130 °C / 266 °F        | high temperature version         |  |   |
| EPDM elastomer               |                                  |  |   |
| flange connection            | see end of the chapter / flanges |  |   |

## Accessories, enclosed

|                  |  |                                      |          |
|------------------|--|--------------------------------------|----------|
| mounting bracket | for G $\frac{1}{8}$                    | (C3002)                              | BW30-03S |
| mounting nut     |  |                                      | M30x1,5S |
| mounting bracket | for G $\frac{1}{4}$ to G $\frac{3}{8}$ | (C3002), for G $\frac{1}{4}$ (C3003) | BW45-03S |
| mounting nut     |  |                                      | M45x1,5S |
| mounting bracket | for G $\frac{1}{2}$ to G1              | (C3002), for G $\frac{1}{2}$ (C3003) | BW50-01S |
| mounting nut     |  |                                      | M50x1,5S |
| mounting bracket |  | for G $\frac{3}{4}$ to G1 (C3003)    | BW00-27S |

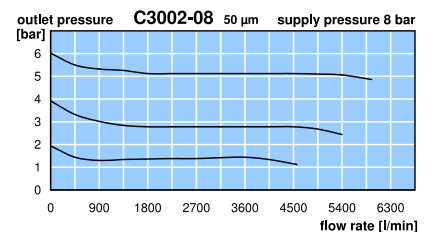
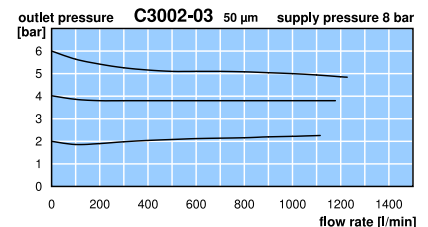
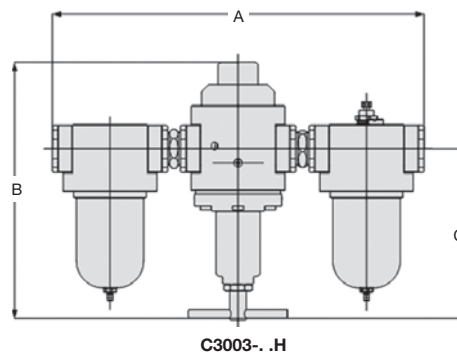
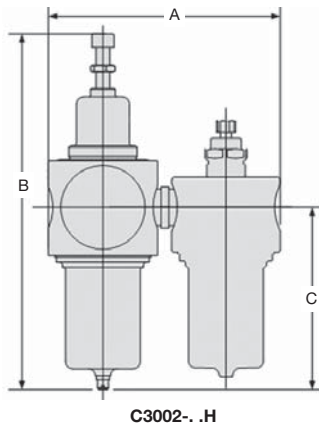

\*1 at 8 bar supply pressure, 6 bar outlet pressure and 1 bar pressure drop

Further details: see chapter for single devices  
Spare parts: see separate spare parts list

PDF CAD  
www.aircom.net

Order example:  
C3002-01

# Stainless Steel FRL Service Unit, Filter and Lubricator

# C10-S / F10-S / L10-S

|                           |  |                |  |
|---------------------------|--|----------------|--|
| <b>Description</b>        | Compact FRL service unit, filter and lubricator made of stainless steel with high volume flow.   |                |  |
| <b>Media</b>              | compressed air or gases  |                |  |
| <b>Supply pressure</b>    | max. 21 bar  |                |  |
| <b>Adjustment</b>         | by plastic knob with snap-lock   |                |  |
| <b>Relieving function</b> | relieving, optionally non-relieving  |                |  |
| <b>Gauge port</b>         | G¼ on both sides of the body of (filter) pressure regulator, screw plugs supplied  |                |  |
| <b>Filter element</b>     | 40 µm of polypropylene at C1., 40 µm, 20 µm and 5 µm of polypropylene and 0.3 µm of borosilicate   |                |  |
| <b>Bowl</b>               | stainless steel version without sight glass, optionally with sight glass   |                |  |
| <b>Drainage</b>           | manual drain as standard for max. 21 bar, optionally automatic drain for max. 12 bar   |                |  |
| <b>Temperature range</b>  | 0 °C to 50 °C / 32 °F to 122 °F for automatic drain version<br>0 °C to 70 °C / 32 °F to 158 °F for stainless steel bowl with sight glass<br>0 °C to 80 °C / 32 °F to 176 °F for stainless steel bowl without sight glass |                |  |
| <b>Material</b>           | Body: stainless steel 316, material no. 1.4401   | Elastomer: FKM | Inner valve: stainless steel and plastic |
|                           | Spring cage: glass fibre-reinforced plastic  |                |  |
|                           | Bowl: stainless steel 316, material no. 1.4401   |                |  |

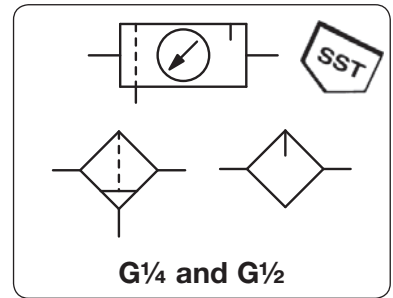

| Dimensions |    |    | Description | Flow rate |         | Filter element | Connection thread | Order number |
|------------|----|----|-------------|-----------|---------|----------------|-------------------|--------------|
| A          | B  | C  |             | m³/h*1    | l/min*1 |                |                   |              |
| mm         | mm | mm |             |           |         |                |                   |              |

| FRL service unit |     |     |             | supply pressure max. 21 bar, outlet 0.3...9 bar, 40 µm, manual drain, relieving, with pressure gauge |      | C10-S/C11-S |    |           |
|------------------|-----|-----|-------------|--|------|-------------|----|-----------|
| 140              | 218 | 127 | B11+L10     | 48   | 800  | 40          | G½ | C11-04CJS |
| 220              | 162 | 127 | F10+R10+L10 | 108  | 1800 |             |    | C10-04CJS |

| Filter |     |     |              | supply pressure max. 21 bar, manual drain, bowl capacity 0.11 l |      | F504-S/F10-S |    |            |
|--------|-----|-----|--------------|---|------|--------------|----|------------|
| 40     | 108 | 94  | Polypropylen | 23  | 380  | 20           | G¼ | F504-02DHS |
|        |     |     | Polypropylen | 20  | 340  | 5            |    | F504-02DGS |
|        |     |     | Coalescing   | 15  | 250  | 0,3          |    | F501-02DHS |
| 60     | 132 | 127 | Polypropylen | 114   | 1900 | 40           | G½ | F10-04DJS  |
|        |     |     | Polypropylen | 102   | 1700 | 5            |    | F10-04DGS  |
|        |     |     | Coalescing   | 58  | 960  | 0,3          |    | F11-04DJS  |

| Lubricator |     |     |  | supply pressure max. 21 bar, bowl capacity 0.11 l |      | L10-S |    |          |
|------------|-----|-----|--|---|------|-------|----|----------|
| 60         | 173 | 127 |  | 180   | 3000 |       | G½ | L10-04DS |

| Special options, add the appropriate letter |                       |                      |                            |
|---|-----------------------|----------------------|----------------------------|
| bowl with sight glass                       | max. 17 bar,          | up to 70 °C / 158 °C | for C1. and F1. .1.-04...W |
| NPT   | connection thread     |                      | .....N                     |
| automatic drain                             | SA10MDSS, max. 12 bar |                      | for C1. and F1. .1.-04...R |

| Accessories, enclosed |  |         |          |
|-----------------------|--|---------|----------|
| mounting bracket      |  | for C1. | BW45-03S |
| mounting nut          |  | for C1. | M45x1,5S |

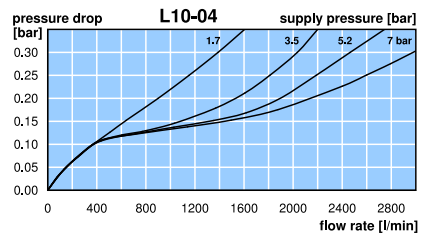
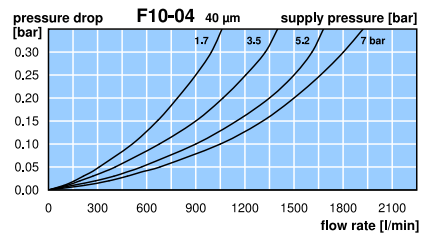
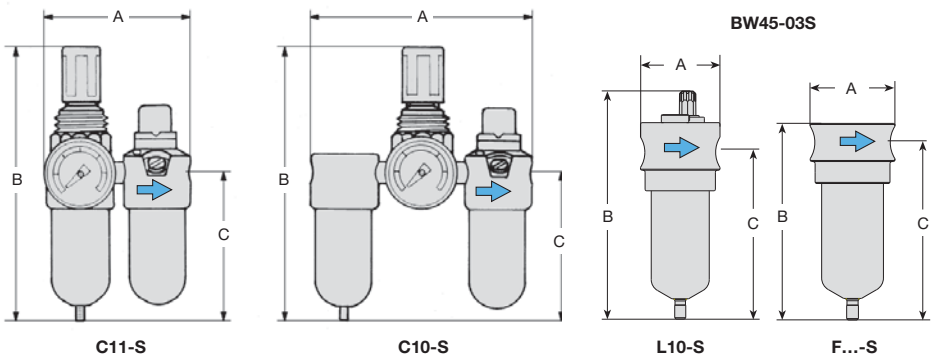

\*1 at 7 bar supply pressure, 6 bar outlet pressure and 0.33 bar pressure drop or 1 bar pressure drop at C10/C11

Further details: see chapter for single devices  
 Spare parts: see separate spare parts list

PDF CAD  
[www.aircom.net](http://www.aircom.net)

Order example:  
**C11-04CJS**



|                          |   |
|--------------------------|---|
| <b>Description</b>       | The flow control valve functions as a pinch valve in a new design of housing with full flow cross-section. Since the straight valve passage has neither constrictions nor back-points, there is no danger of clogging or blockage. Frictional loss is at a minimum. |
| <b>Media</b>             | compressed air, gases, liquids or other paste-like or powdery media<br>Solids are enclosed by the flexible sleeve at shut-off.  |
| <b>Sleeve</b>            | Highly flexible with double woven reinforcement in eight different grades. Sleeve simple to change.   |
| <b>Pressures</b>         | Operating pressure: max. 4.0 bar Pilot pressure: max. 6.5<br>Differential pressure: max. 2.5 bar Closing pressure: $P_1 + 2.5$ bar to DN32, $P_1 + 2$ bar from DN40 on  |
| <b>Vacuum</b>            | If vacuum is greater than -100 mbar, vacuum compensation should be provided on the control side.  |
| <b>Accuracy</b>          | In the flow range of 0 to 70% the linearity of pilot pressure to flow is about 10% accurate.  |
| <b>Mounting position</b> | any, at horizontal mounting pilot port preferably at the top  |
| <b>Temperature range</b> | 0 °C to max. 100 °C / 32 °F to max. 212 °F, subject to sleeve material  |
| <b>Material</b>          | Body: stainless steel 316L, material no. 1.4435 Sleeve: depending on selected version   |

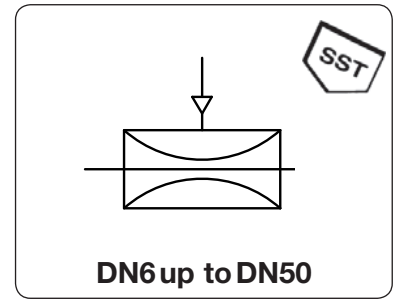

| Dimensions | Nominal size | Chamber capacity | Control port | Operating pressure | Connection thread | Order number |
|------------|--------------|------------------|--------------|--------------------|-------------------|--------------|
| A          | Ø            | I                | M5/G         | max. bar           | G                 |              |
| mm         | mm           | l                |              |                    |                   |              |

| Flow control valve |    |    |      |    |   | operating pressure max. 4 bar, pilot pressure max. 2.5 bar above operating pressure |  | QE        |
|--------------------|----|----|------|----|---|---|--|-----------|
| 70                 | 26 | 6  | 0.01 | M5 | 4 | G¼  |  | QE06-02NR |
| 80                 | 38 | 10 | 0.03 | M5 | 4 | G¾  |  | QE10-03NR |
| 95                 | 44 | 15 | 0.04 | G½ | 4 | G½  |  | QE15-04NR |
| 110                | 55 | 20 | 0.05 | G½ | 4 | G¾  |  | QE20-06NR |
| 125                | 60 | 25 | 0.07 | G½ | 4 | G1  |  | QE25-08NR |
| 140                | 73 | 32 | 0.10 | G½ | 4 | G1¼   |  | QE32-10NR |
| 150                | 83 | 40 | 0.13 | G½ | 4 | G1½   |  | QE40-12NR |
| 185                | 99 | 50 | 0.28 | G¼ | 4 | G2  |  | QE50-16NR |



### Special options, add the appropriate letter

|                    |   |                       |         |
|--------------------|---|-----------------------|---------|
| <b>sleeve NR</b>   | natural rubber, black                               | 80°C/176 °F           | QE...NR |
| <b>sleeve NRL</b>  | rubber, suitable for food, black                    | 70°C/158 °F           | QE...NL |
| <b>sleeve NRLH</b> | rubber, suitable for food, light                    | 70°C/158 °F           | QE...NH |
| <b>sleeve NBR</b>  | nitrile rubber/Buna-N, suitable for food            | 80°C/176 °F           | QE...NB |
| <b>sleeve EPDM</b> | ethylene-propylene rubber, suitable for food, black | 100°C/212 °F          | QE...EP |
| <b>sleeve FKM</b>  | fluorine rubber, black                              | not QE06 100°C/212 °F | QE...FK |
| <b>sleeve CR</b>   | chloroprene rubber/neoprene, black                  | not QE06 80°C/176 °F  | QE...CR |
| <b>sleeve CSM</b>  | natural rubber, chlorosulphonyl/polyethylene        | not QE06 80°C/176 °F  | QE...CS |

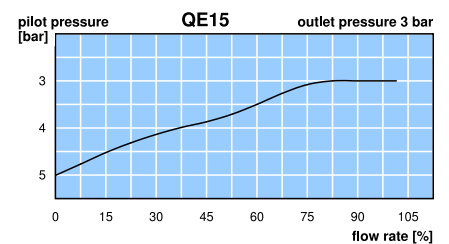
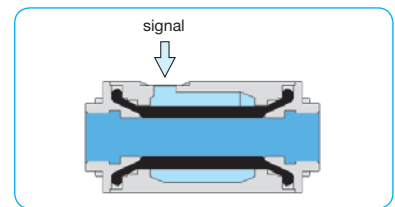
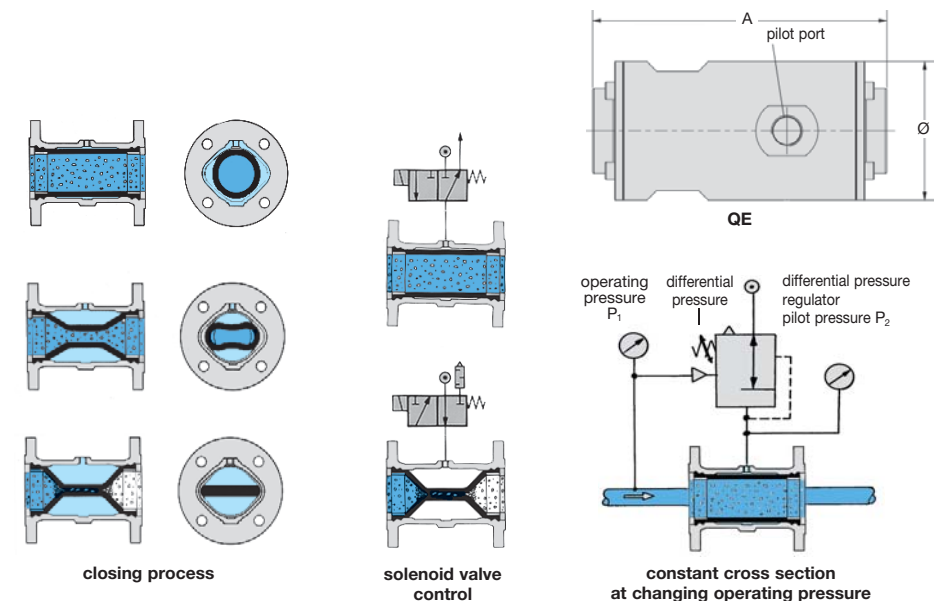

For further pinch valves made of POM or aluminium see chapter for special devices

PDF CAD  
www.aircom.net

Order example:  
QE06-02NR

# Mounting Flange

..F

|                           |  |  |
|---------------------------|--|--|
| <b>Total device width</b> | device width between inlet and outlet, see catalogue page, dimension A |  |
|                           | + 2x total length of flange fitting, dimension L                       |  |
|                           | - 2x screw-in depth of the device (on request)                         |  |
|                           | = total device width including flange                                  |  |
| <b>DIN flange</b>         | according to DIN 2635 at PN40,   | according to DIN 2637 at PN100               |
| <b>ANSI flange</b>        | optionally according to ASME B16.5 (150 lbs),                          | according to ASME B16.5 (300 lbs) on request |
| <b>Material</b>           | stainless steel, material number 1.4571                                |  |

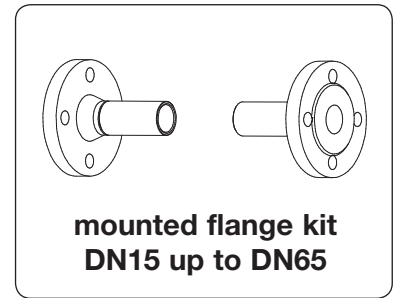

|                              |                   |                        |                            |                           |
|------------------------------|-------------------|------------------------|----------------------------|---------------------------|
| <b>Nominal pressure max.</b> | <b>for device</b> | <b>Nominal size DN</b> | <b>Connection thread G</b> | <b>Order number affix</b> |
|------------------------------|-------------------|------------------------|----------------------------|---------------------------|

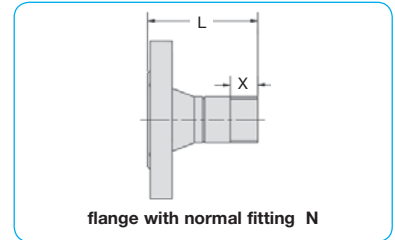

## Flange kit, DIN, completely assembled F

|              |              |           |           |    |           |           |
|--------------|--------------|-----------|-----------|----|-----------|-----------|
| <b>PN40</b>  | BD and BM/40 | F602      | R119      | 15 | G½        | <b>F1</b> |
|              | CM/40        | F3000/40  | R3000     | 20 | G¾        | <b>F1</b> |
|              | C3000/40     | L606      | R3100/L   | 25 | G1        | <b>F1</b> |
|              | D3100/L      | LM/40     | RZ/L      | 32 | G1¼       | <b>F1</b> |
|              | DBC/L        | L3000/40  | R160/L    | 40 | G1½       | <b>F1</b> |
|              | R120/40      | FM/40     |           | 50 | G2        | <b>F1</b> |
|              |              |           |           | 65 | G2½       | <b>F1</b> |
|              |              |           | 80        | G3 | <b>F1</b> |           |
| <b>PN100</b> | BM/100       | FM        | LM/100    | 15 | G½        | <b>F1</b> |
|              | CM/100       | F3000/100 | L3000/100 | 20 | G¾        | <b>F1</b> |
|              | C3000/100    | R120/100  | R3000/100 | 25 | G1        | <b>F1</b> |
|              |              |           |           | 32 | G1¼       | <b>F1</b> |
|              |              |           |           | 40 | G1½       | <b>F1</b> |
|              |              |           |           | 50 | G2        | <b>F1</b> |
|              |              |           |           | 65 | G2½       | <b>F1</b> |

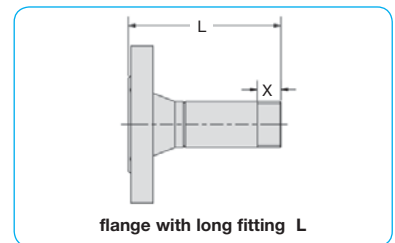

| thread | fitting N |       | fitting L |       | thread |
|--------|-----------|-------|-----------|-------|--------|
|        | PN40      | PN100 | PN40      | PN100 |        |
|        | L mm      |       | L mm      |       | X mm   |
| G½     | 75        | 82    | 90        | 97    | 15     |
| G¾     | 82        | 94    | 112       | 124   | 17     |
| G1     | 82        | 100   | 112       | 130   | 20     |
| G1¼    | 94        | 112   | 114       | 132   | 22     |
| G1½    | 97        | 114   | 117       | 134   | 22     |
| G2     | 100       | 120   | 120       | 140   | 26     |
| G2½    | 114       | 138   | 124       | 148   | 32     |

## Special options

|                    |         |           |
|--------------------|---------|-----------|
| <b>ANSI flange</b> | 150 lbs | <b>F2</b> |
|                    | 300 lbs | <b>F3</b> |
|                    | 600 lbs | <b>F4</b> |



| filter regulator | PN     | fitting* |
|------------------|--------|----------|
| BD               | 40     | N        |
| BM               | 40/100 | N        |

| lubricator | PN     | fitting* |
|------------|--------|----------|
| L606       | 40     | N        |
| LM         | 40/100 | N        |
| L3000      | 40/100 | N        |

| regulator | PN     | fitting* |
|-----------|--------|----------|
| R119      | 40     | N        |
| R120      | 40/100 | N        |
| R3000     | 40/100 | N        |

| filter | PN     | fitting* |
|--------|--------|----------|
| F602   | 40     | N        |
| FM     | 40/100 | N        |
| F3000  | 40/100 | N        |

| booster | PN     | fitting* |
|---------|--------|----------|
| R119-J  | 40     | N        |
| R120-J  | 40/100 | N        |
| R3000-J | 40/100 | N        |

| low pressure regulator | PN | fitting* |
|------------------------|----|----------|
| R3100                  | 40 | L        |
| D3100                  | 40 | L        |
| RZ                     | 40 | L        |
| R160                   | 40 | L        |
| DBC                    | 40 | L        |

| FRL service unit | PN     | fitting* |
|------------------|--------|----------|
| CM2              | 40/100 | N        |
| C3002            | 40/100 | N        |

| FRL service unit | PN     | fitting* |
|------------------|--------|----------|
| C630             | 40     | N        |
| CM3              | 40/100 | N        |
| C3003            | 40/100 | N        |

\* N = normal fitting    L = long fitting

|                            |  |  |                      |
|----------------------------|--|--|----------------------|
| <b>Threaded flange</b>     | according to DIN 2566 (PN 16)                                  |  |                      |
| <b>Welding neck flange</b> | according to DIN 2635 (PN 40),<br>ANSI / ASME B16.5 (150 lbs), | according to DIN 2637 (PN 100),<br>ASME B16.5 (300 lbs), | ASME B16.5 (600 lbs) |
| <b>Material</b>            | stainless steel 316TI, material number 1.4571                  |  |                      |
| <b>Weld-on fitting</b>     | with conical Whitworth thread (BSPT) according to DIN 2999     |  |                      |
| <b>Material</b>            | stainless steel, material number 1.4571                        |  |                      |

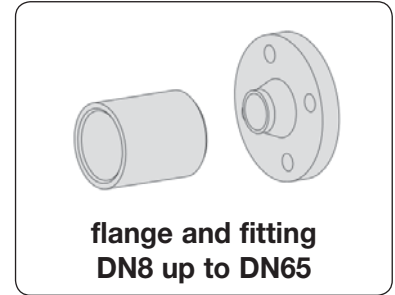

| d1/s | Dimensions |                |   |                |   |   |                |                | Screws | Connection<br>thread<br>Rp | Nomial<br>size<br>DN | Order<br>number |
|------|------------|----------------|---|----------------|---|---|----------------|----------------|--------|----------------------------|----------------------|-----------------|
|      | D          | h <sub>1</sub> | b | d <sub>4</sub> | f | k | d <sub>2</sub> | d <sub>3</sub> |        |                            |                      |                 |

| Welding neck flange as per DIN 2635 (PN40) |     |    |    |     |   |     |    |     |         |   | VSV |                 |
|--|-----|----|----|-----|---|-----|----|-----|---------|---|-----|-----------------|
| 21.3 x 2.0                                 | 95  | 36 | 16 | 45  | 2 | 65  | 14 | 32  | 4 x M12 | - | 15  | <b>VSV-1540</b> |
| 26.9 x 2.3                                 | 105 | 40 | 18 | 58  | 2 | 75  | 14 | 40  | 4 x M12 | - | 20  | <b>VSV-2040</b> |
| 33.7 x 2.6                                 | 115 | 40 | 18 | 68  | 2 | 85  | 14 | 46  | 4 x M12 | - | 25  | <b>VSV-2540</b> |
| 42.4 x 2.6                                 | 140 | 42 | 18 | 78  | 2 | 100 | 18 | 56  | 4 x M16 | - | 32  | <b>VSV-3240</b> |
| 48.3 x 2.6                                 | 150 | 45 | 18 | 88  | 3 | 110 | 18 | 64  | 4 x M16 | - | 40  | <b>VSV-4040</b> |
| 60.3 x 2.9                                 | 165 | 48 | 20 | 102 | 3 | 125 | 18 | 75  | 4 x M16 | - | 50  | <b>VSV-5040</b> |
| 76.1 x 2.9                                 | 185 | 52 | 22 | 122 | 3 | 145 | 18 | 90  | 4 x M16 | - | 65  | <b>VSV-6540</b> |
| 88.9 x 3.2                                 | 200 | 58 | 24 | 138 | 3 | 160 | 18 | 105 | 8 x M16 | - | 80  | <b>VSV-8040</b> |

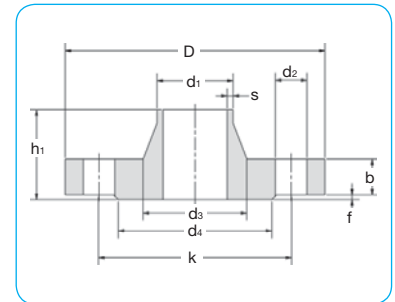

VSV welding neck flange

### Special options, add the appropriate letter or number

|                         |                        |                |                |
|-------------------------|------------------------|----------------|----------------|
| <b>PN100</b>            | as per DIN 2637        | <b>100</b>     | VSV-...100     |
| <b>ANSI/ASME flange</b> | B16.5 150 lbs          | <b>150 lbs</b> | VSV-...150 lbs |
| <b>ANSI/ASME flange</b> | B16.5 300 lbs          | <b>300 lbs</b> | VSV-...300 lbs |
| <b>ANSI/ASME flange</b> | B16.5 600 lbs bis DN25 | <b>600 lbs</b> | VSV-...600 lbs |

| Weld-on fitting |    | as per DIN 2999 with conical Whitworth thread (BSPT) |        |    | VSA           |
|-----------------|----|--|--------|----|---------------|
| 13.5 x 2.35     | 30 | PN50   | 1/4"   | 8  | <b>VSA-02</b> |
| 21.3 x 2.65     | 35 | PN50   | 1/2"   | 15 | <b>VSA-04</b> |
| 26.9 x 2.65     | 40 | PN50   | 3/4"   | 20 | <b>VSA-06</b> |
| 33.7 x 3.25     | 40 | PN50   | 1"     | 25 | <b>VSA-08</b> |
| 42.4 x 3.25     | 50 | PN40   | 1 1/4" | 32 | <b>VSA-10</b> |
| 48.3 x 3.25     | 50 | PN40   | 1 1/2" | 40 | <b>VSA-12</b> |
| 60.3 x 3.65     | 50 | PN40   | 2"     | 50 | <b>VSA-16</b> |
| 76.1 x 3.65     | 60 | PN25   | 2 1/2" | 65 | <b>VSA-20</b> |

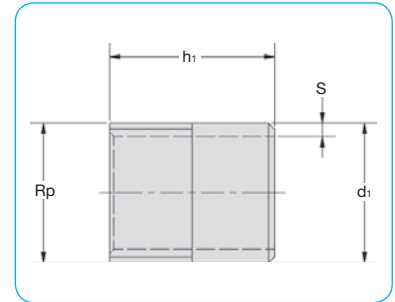

VSA weld-on fitting

