



PRODUCTS & SERVICES

BALDOR • DODGE®



**Our mission is to be the best
(as determined by our customers)
marketers, designers and manufacturers
of industrial electric motors, drives and
mechanical power transmission products**

Taking care of our customers safely

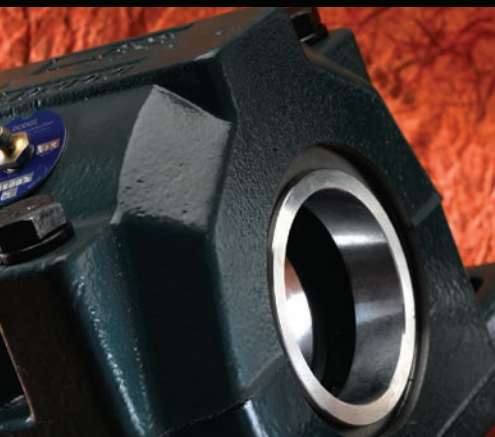

POWER PLUS PERFORMANCE

WHO KNEW POWER COULD ADD UP TO SO MUCH

With Baldor•Dodge products, you get more than just power. You get the widest range of mechanical products available – plus the added assurance of a reliable partner dedicated to responsive service and complete support.

For well over a century, Baldor•Dodge products have helped manufacturers, OEMs, and producers increase the productivity and profitability of their operations. By focusing on each industry and concentrating on its specific needs, we have developed innovative product solutions and advanced technologies that help improve output, decrease downtime, and enhance system value.

Only Baldor•Dodge products offer you a total mechanical power transmission solution: rugged, reliable products with patented features along with experienced field experts.

When you add all these things up, you get the absolute assurance of Power Plus Performance.

*With
Baldor•Dodge
products you get the
absolute assurance of
Power Plus Performance
and industry-specific
solutions from experts who
understand the products
they are selling and the
environment in which these
products are used.*



Mounted Bearings

Mounted Ball Bearings
Mounted Tapered Roller Bearings
Mounted Spherical Roller Bearings
Mounted Plain Bearings
Hydrodynamic Bearings
Take-Up Frames

Gearing

TORQUE-ARM® Shaft Mount Reducers
TORQUE-ARM II™ Shaft Mount Reducers
TORQUE-ARM II Motorized Shaft Mount Reducers
TIGEAR-2® Speed Reducers
QUANTIS® Reducers & Gearmotors
MAXUM® XTR Concentric Speed Reducers
CST® (Controlled Start Transmissions)
MAGNAGEAR XTR™

PT Components

Couplings
Conveyor Components
Conveyor Pulleys
Weld-On Hubs
Bushings
Sprockets
Synchronous Belt Drives
Sheaves
V-Belt Drives
Motor Brakes
Clutch/Brake Modules

System-1

- Integrated solution for multiple-product power transmission projects
- Complete package of optimized, performance-matched Baldor•Reliance and Baldor•Dodge products
- Single point of contact for project management
- Total-package shipping under one part number
- Pre-Engineered Drive Packages



Recognized for world-class efforts, LEAN practices, innovative technologies, and improvement strategies, Baldor•Dodge Marion, NC and Asheville (Weaverville, NC) plants have both been named one of Industry Week's Top 10 Best Plants. The Baldor•Dodge Marion plant manufactures Type-E, S-2000 and S-2000-E, and IMPERIAL and IMPERIAL-E Bearings. The Asheville plant in Weaverville, NC manufactures Mechanical Drive Components, Couplings and Hydrodynamic Bearings.



For Baldor•Dodge contact info and to locate a distributor near you:

- Please visit www.baldor.com

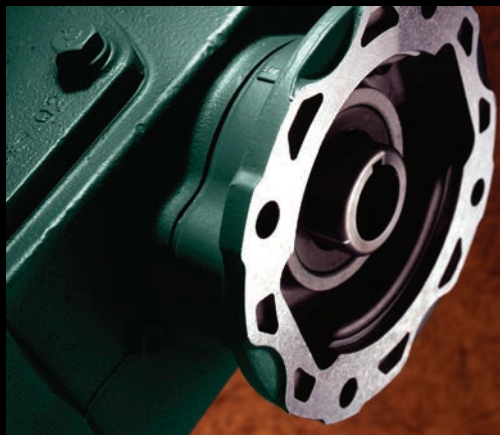

MOUNTED BALL



For more than 120 years, Baldor•Dodge has been one of the leading suppliers of power transmission products and system components in the world. Today we utilize our global resources to ensure that bearing users throughout the world have access to the highest quality and best selection of mounted bearings in the industry.

When it comes to reliable service and low maintenance, Baldor•Dodge mounted ball bearings are unmatched in the industry. Baldor•Dodge mounted ball bearings are available in any of our proven locking devices: our exclusive 65° set screw locking system, eccentric locking collars, D-LOK™ concentric clamp locking system and our patented* GRIP TIGHT® adapter mounted ball bearing.

All Baldor•Dodge mounted bearing products are backed by our worldwide distribution system and our highly trained and experienced technical sales team.

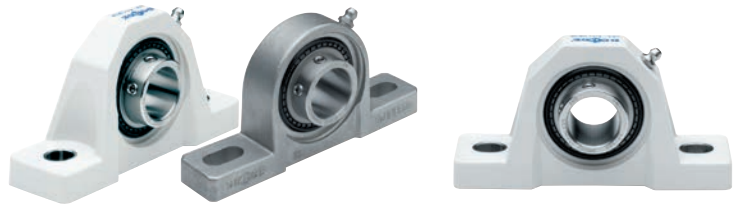

Ultra Kleen Ball Bearings

- 440C stainless steel insert
- Polymer and stainless housings
- 65° set screw
- 3/4" - 2" bore
- 20 - 55 mm metric bore
- QuadGuard triple-lip seal with rubberized flinger
- Stainless balls
- Maxlife cage
- Snap-on end-covers
- Nomenclature: P2B-SCEZ-100-PSS
 - PSS = Polymer Housing, Stainless Insert
 - SHSS = Stainless Housing, Stainless Insert

E-Z KLEEN Corrosion Resistant Ball Bearings

- Reinforced polymer and stainless steel housings
- Patented polymer housing includes anti-microbial agent which resists bacterial and fungus growth
- Corrosion resistant, coated insert
- Three locking devices: 65° set screw angle (SC), concentric clamp collar (D-LOK), and GRIP TIGHT® adapter mount
- QuadGuard seal – comprised of our triple lip seal and unique rubberized flinger. Additional grease retention provided by the Maxlife cage.
- Interchangeable mounting dimensions with most competitive products
- Anti-rotation device prevents insert rotation associated with heavy loads, vibration, unbalanced loads, and high-speed applications
- Plus or minus 2° static misalignment

Baldor•Dodge Ball Bearing Key Industries

- AGGREGATE / CEMENT
- MINING
- HVAC / AIR HANDLING
- UNIT / BAGGAGE HANDLING
- FOOD / BEVERAGE / PHARMACEUTICAL
- FOREST / PAPER PRODUCTS
- METALS



Extreme Duty Ball Bearings

- Harsh-duty seals are standard
- QuadGuard triple-lip seal with rubberized flinger
- Maxlife cage
- Synthetic grease is standard – Mobilith SHC 220 PM
- Snap-on end covers
- 65° set screw
- Wide inner ring design
- Anti-rotation pin to prevent insert from spinning in housing
- Grade 10 balls
- Bore range
 - SC - 3/4" to 2-15/16", 20 mm to 75 mm
 - SCM - 1" to 3-1/2", 25 mm to 85 mm



Set Screw Ball Bearings

- Four types: normal duty SC, medium duty SCM, intermediate duty VSC, and light duty SL
- DualGuard seal – comprised of single lip seal and rubberized flinger – standard on all SC, SCM ball bearings. LL Lo Torque Labyrinth seals optional. Snap-on end covers available from stock for most popular cast housings.
- Interchangeable mounting dimensions with most competitive products
- 65° set screw angle for greater holding power and ease of installation in confined areas
- Anti-rotation device on SC and SCM bearings prevents insert rotation associated with heavy loads, vibration, unbalanced loads, and high-speed applications
- Expansion pillow blocks available for popular shaft sizes
- High-temperature option available to 400°F on SC and SCM
- Plus or minus 2° static misalignment



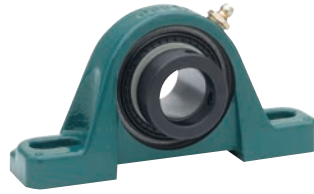

GRIP TIGHT Ball Bearings

- Two types: normal duty GT and medium duty GTM
- DualGuard seal – comprised of single lip seal and rubberized flinger – standard on all GT, GTM ball bearings. LL Lo Torque Labyrinth seals optional. Snap-on end covers available from stock for most popular cast housings.
- Interchangeable mounting dimensions with most competitive set screw, eccentric collar, and concentric clamp collar products
- Thin wall adapter mounting offers 360° full shaft contact and concentricity. No shaft marring or fretting corrosion like setscrew and eccentric collar products. Integral dismount feature easily removes the bearing from the shaft. Turned, ground, and polished shafting is not required.
- Anti-rotation device prevents insert rotation associated with heavy loads, vibration, unbalanced loads, and high-speed applications
- Expansion pillow blocks available for popular shaft sizes
- High-temperature option available to 400°F

Eccentric Collar Ball Bearings

- Three types: normal duty SXR, intermediate duty SXV, and light duty SLX
- DualGuard seal – comprised of single lip seal and rubberized flinger – standard on all SXR ball bearings. LL Lo Torque Labyrinth seals optional. Snap-on end covers available from stock for most popular cast housings.
- Interchangeable mounting dimensions with most competitive products
- Eccentric collar locks the bearing to the shaft by a quarter turn of the collar in direction of shaft rotation; collar is secured in place with set screw
- Anti-rotation device on SXR prevents insert rotation associated with heavy loads, vibration, unbalanced loads, and high-speed applications
- Expansion pillow blocks available for popular shaft sizes
- High-temperature option available to 400°F on SXR
- Plus or minus 2° static misalignment

D-LOK Ball Bearings

- Two types: normal duty DL and medium duty DLM
- DualGuard seal – comprised of single lip seal and rubberized flinger – standard on all DL, DLM ball bearings. LL Lo Torque Labyrinth seals optional. Snap-on end covers available from stock for most popular cast housings.
- Interchangeable mounting dimensions with most competitive products
- Concentric clamp collar locks the bearing to the shaft by tightening a single Allen wrench cap screw; the bearing will not mar the shaft like set screw and eccentric collar bearings; provides concentricity between the bearing and shaft
- Anti-rotation device prevents insert rotation associated with heavy loads, vibration, unbalanced loads, and high-speed applications
- Expansion pillow blocks available for popular shaft sizes
- High-temperature option available to 400°F
- Plus or minus 2° static misalignment

ER Series Ball Bearings

- High-quality Dodge-manufactured bearings
- Cylindrical outer diameter with snap-ring retention to fit user equipment
- Availability in two shaft attachment methods:
 - Set screw (ER-SC) – 65° set screw angle for maximum shaft grip
 - D-Lok™ (ER-DL) – Clamp collar grip for maximum concentricity to minimize vibration
- Size ranges:
 - Set screw – 204 series (3/4" bore size) through 218 series (3-7/16" bore size)
 - D-Lok™ – 204 series (3/4" bore size) through 212 series (2-7/16" bore size)
- Dodge's mechanically-retained ProGuard™ seal and flinger package to prevent contamination and maximize product life in dirty applications

Other Common Modifications:

- Air handling mounted ball bearings
- Air baggage handling systems
- CC® Fan and Blower pillow blocks

ADVANCEMENTS THAT LOWER YOUR TOTAL COST OF OWNERSHIP

DualGuard Seal

Comprised of single lip seal and rubberized flinger – included on all standard duty ball bearings. LL Lo Torque Labyrinth seals optional. Snap-on end covers available from stock for most popular cast housings.

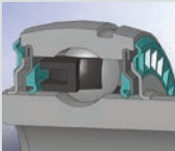

than steel or normal fiberglass, especially under misalignment. That means longer life in mounted bearings where some degree of misalignment is unavoidably encountered.

Anti-Rotation Pin

An anti-rotation pin prevents rotation of the outer race within the housing. Simple and effective, it makes system inserts easier to replace. There is no need to remove and replace grease fittings, location pins or other devices.



Snap-On End Covers

Baldor•Dodge also offers a series of injection-molded, impact resistant end covers. Covers are manufactured in OSHA safety yellow and fit many

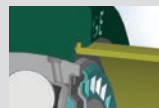

styles of Baldor•Dodge cast-iron-housed ball bearings.



QuadGuard Seal

- Triple-lip seal provides 3 points of contact to keep contaminants out and keep grease in.
- Mechanically retained seal for added strength – allows grease to purge without blowing seals.
- Patented design of the triple-lip seal produces less drag than competitive offerings.
- Rubberized flinger provides external protection and discards contaminants as it rotates.
- Molded baffles in flinger act like a paddle wheel to help deflect liquids.



- Molded rubber increases the radius of the flinger which increases the acceleration rate of the contaminants as they are thrown away from the bearing.
- Rubber molding on the flinger is extended to the outer race of the bearing, providing better protection than non-rubberized offerings.

Maxlife Cage

- Two-piece design
- Creates compartments that keep grease in close contact to balls
- Compartments help prevent grease from being washed out during high pressure cleaning
- Cooler operating temperatures extend life of grease
- Maxlife cage is standard for Extreme Duty and Ultra/E-Z Klean ball bearings



Stronger, More Flexible Cage

The ball cage is made of heat stabilized nylon with 33% fill short fiberglass reinforcement for added strength. The nylon material provides a natural lubricity for longer life. Fiberglass reinforcement allows higher operating temperatures than plain nylon, yet is more resistant to fatigue than metallic cages. Short fiberglass allows greater flexibility



	Set screw		GRIP TIGHT		Eccentric		D-LOK		E-Z KLEEN / ULTRA-KLEEN	
Pillow Blocks	1/2 - 3-1/2	17mm - 90mm	1/2 - 3-1/2	17mm - 85mm	1/2 - 2-15/16	17mm - 75mm	3/4 - 3-7/16	20mm - 70mm	3/4 - 2	20mm - 50mm
Tapped Base Pillow Blocks	1/2 - 2-1/4	20mm - 55mm	3/4 - 2-1/4	20mm - 55mm	3/4 - 2-3/16	20mm - 55mm	3/4 - 2-3/16	20mm - 55mm	3/4 - 2	20mm - 50mm
2 & 4 Bolt Flanges	1/2 - 3-1/2	17mm - 90mm	1/2 - 3-1/2	17mm - 85mm	1/2 - 2-15/16	17mm - 75mm	3/4 - 3-7/16	20mm - 70mm	3/4 - 2	20mm - 50mm
Flanged Brackets	1/2 - 2	20mm - 50mm	3/4 - 2	20mm - 50mm	3/4 - 2	20mm - 50mm	3/4 - 2	20mm - 50mm	3/4 - 2	20mm - 50mm
LFT & LF 2 & 3 Bolt Flanges	1/2 - 1-7/16	17mm - 35mm	1/2 - 1-7/16	17mm - 35mm	1/2 - 1-7/16	17mm - 35mm	3/4 - 1-7/16	20mm - 35mm	3/4 - 1-7/16	20mm - 35mm
Piloted Flanges	1 - 3-1/2	25mm - 90mm	1 - 3-1/2	25mm - 85mm	1-1/8 - 2-7/16	25mm - 60mm	1 - 3-7/16	25mm - 70mm	N/A	N/A
Take-Up Bearings	1/2 - 3-1/2	20mm - 90mm	3/4 - 3-1/2	20mm - 85mm	3/4 - 2-15/16	20mm - 75mm	3/4 - 3-7/16	20mm - 70mm	3/4 - 2	20mm - 50mm
Hanger Bearings	1-1/16 - 2	30mm - 50mm	N/A	N/A	1-1/16 - 2	30mm - 50mm	N/A	N/A	N/A	N/A
Screw Conveyor Hanger Bearings	1 - 3-1/2	25mm - 90mm	1 - 3-1/2	25mm - 85mm	1-7/16 - 2-7/16	35mm - 60mm	1 - 3-7/16	25mm - 70mm	N/A	N/A
Cylindrical Units	7/8 - 1-7/16	25mm - 35mm	N/A	N/A	7/8 - 1-7/16	25mm - 35mm	7/8 - 1-7/16	25mm - 35mm	N/A	N/A

MOUNTED ROLLER



Only one name is synonymous with the finest-quality mounted tapered and spherical roller bearings: Baldor•Dodge. We are the standard against which all other bearings are compared.

For decades, industry's leading producers have depended on our roller bearings to handle their conveyance and power transmission needs. Did you know that Baldor•Dodge developed the original Type E bearing in the 1940's? Throughout the years, its reputation for reliability has remained, and from that innovation and engineering a complete family of roller bearings has evolved. Today, our bearings offer innovative designs; a wide range of shaft attachment methods, rolling elements, housings, and seal choices; patented features; and consistent performance.



Type E-XTRA® Tapered Roller Bearings

- Completely assembled, factory adjusted, and properly lubricated – shaft ready
- XTS triple-lip seal
- Extra protection – E-TECT seal option
- Tapered rolling elements
- E-XTRA allows easy upgrade from ball bearings



Type EXL Tapered Roller Bearing

- Split-cap, ductile iron housing
- Type E mounting dimensions
- XTS triple-lip seal
- 4° misalignment capability
- Expansion and non-expansion



TAF Tapered Roller Bearings

- Interchangeable with SAF style pillow blocks
- XTS triple-lip seal
- E-TECT seal option available up to 7"
- Shaft ready – mounts six times faster than SAF
- Self aligning, factory assembled, adjusted, and lubricated – shaft ready
- Up to 5° static misalignment



DOUBLE INTERLOCK Tapered Roller Bearings

- Tapered roller bearing durability in a variety of styles
- XTS triple-lip seal
- Extra protection E-TECT seal option
- Factory assembled, adjusted, and lubricated – shaft ready
- Special clearances and greases available



Type K Tapered Roller Bearings

- Tapered roller bearing with reduced length through bore
- Single collar design saves space and installation time
- Allows bearing to be closer to the load for reduced shaft deflection
- Self aligning
- Factory assembled, adjusted, and lubricated – shaft ready
- Dimensionally interchangeable with DOUBLE INTERLOCK
- XTS triple lip seal
- Extra protection – E-TECT Seal Option



Special Duty Tapered Roller Bearings

- High capacity tapered roller bearing
- Tapered adapter sleeve mounting
- Effective piston ring seals
- Rugged two-piece housing
- Heavy duty gray iron housing

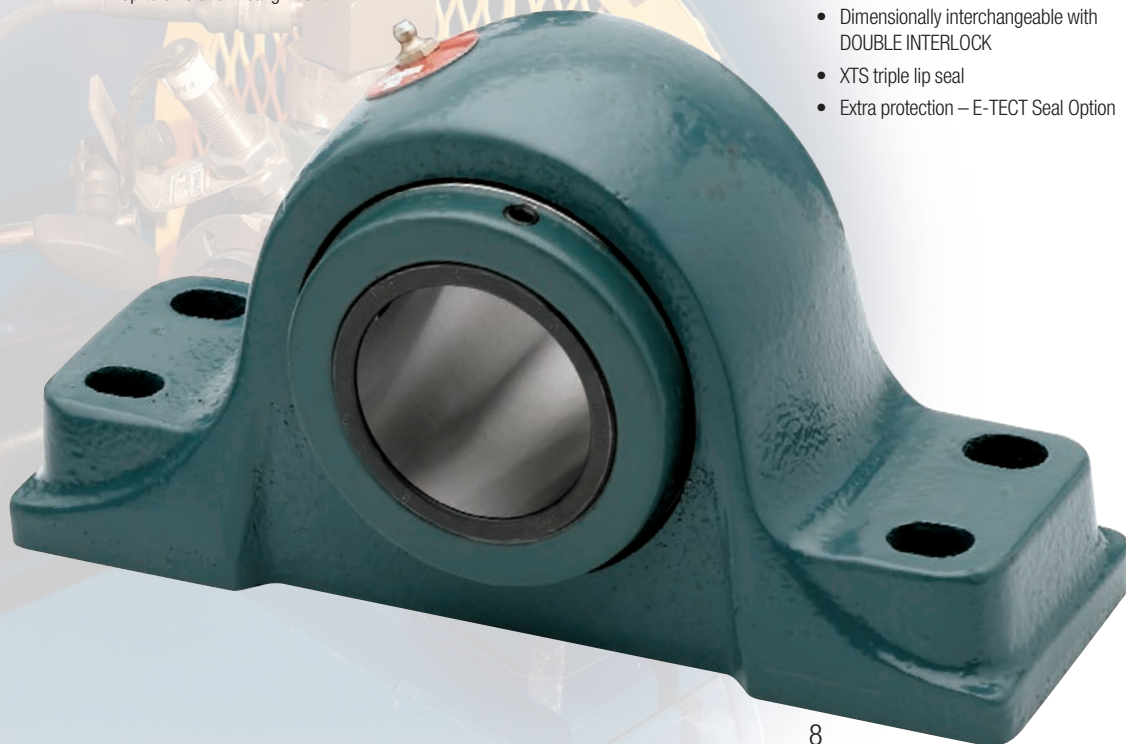

Baldor•Dodge Roller Bearing Key Industries

- AGGREGATE / CEMENT
- MINING / METALS
- AIR HANDLING
- FOREST / PAPER PRODUCTS
- POWER GENERATION
- WATER / WASTE WATER
- SUGAR



IMPERIAL IP Spherical Roller Bearings

- Industry's only push/pull adapter mount system
- Available in 2-bolt and 4-bolt pillow blocks, flanges, and take-ups
- Available with TRIDENT triple lip and labyrinth seal options
- Accepts commercial tolerance shafting
- Full concentric shaft attachment with adapter sleeve mount
- Virtually eliminates fretting corrosion
- Capable of withstanding static or dynamic misalignment of $\pm 1^\circ$
- Shaft-ready out of the box
- Available in Type E dimensions and steel housings



ISAF Spherical Roller Bearings

- Dimensionally interchangeable with SAF style pillow blocks
- Patented IMPERIAL adapter mounting system
- Easy installation – no feeler gauges needed
- Available with TRIDENT triple lip and labyrinth seal options
- $\pm 1^\circ$ static or dynamic misalignment capability
- Virtually eliminates fretting corrosion
- Shaft-ready out of the box, no assembly of components necessary



Hydraulic ISAF Spherical Roller Bearings

- Built in hydraulic mount and dismount system
- Dimensionally interchangeable with SAF style products
- Combination triple-lip and auxiliary sealing system
- Available in 22200, 23000, and 23100 series
- High strength ductile iron housing



S-2000 Spherical Roller Bearings

- High-capacity, double-row spherical rollers
- Permits static or dynamic misalignment of $\pm 1^\circ$
- Factory sealed, lubed, and adjusted
- Available with TRIDENT triple lip and labyrinth seal options
- Springlok collar mount with 65° setscrew spacing for optimum clamping force
- Available in Type E dimensions and steel housings



USAF Spherical Roller Bearings

- 22200, 22300, 23000, 23100, and 23200 Series
- Totally Split Spherical Bearings available
- Industry-standard dimensions interchangeable with SAF housings
- Five sealing options to match most operating conditions
- Cast-in dimples locate drill holes for lube fitting, vents, sensors, and mounting modifications
- Standard housings have two oversized drains adaptable for circulating oil systems
- Pry slots allow easy separation of the pillow block



HD-Steel-Housed Spherical Roller Bearings

- Cast steel housings
- S2000 and Type E mounting dimensions
- Imperial and set screw locking
- Trident triple lip and labyrinth seal options



UNISPHERE® II Spherical Roller Bearings

- Comparable mounting dimensions with ball bearings
- Approximately five times the rating of ball bearings
- Features same rolling elements and installation-ready components as S-2000
- Maintains sealing effectiveness with proven "R" seal
- Tapered seal area maintains seal contact during maximum misalignment
- Springlok collar mount with 65° setscrew spacing for optimum clamping force

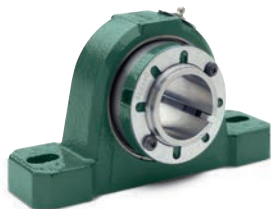

ISN Spherical Roller Bearings

- Dimensionally interchangeable with SN style bearings
- Patented push/pull adapter mount system
- Metric and inch bore sizes
- Trident triple lip and labyrinth seal options



SNX/SDX Spherical Roller Bearings

- Matches industry standard SN and SD mounting dimensions
- 22200, 22300, 23000, 23100 series
- Multiple seal options
- Grease or oil lubrication

ADVANCEMENTS THAT LOWER YOUR TOTAL COST OF OWNERSHIP

PATENTED SEALING SYSTEMS

An ineffective seal can allow contaminants to enter into a bearing, which can cause failure. However, with IMPERIAL and S2000 bearings, you get two exclusive seals for maximum sealing protection.

TRIDENT Seals

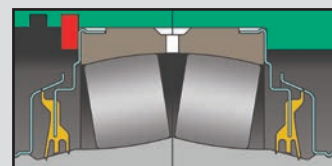

For dirty environments, low-to-medium speeds, and normal ambient conditions, these inserts feature our proven TRIDENT seal. Made of nitrile material, this triple-lip rubbing seal assures a low coefficient of friction, and its seal land maintains full seal contact when misaligned.

Labyrinth Seals

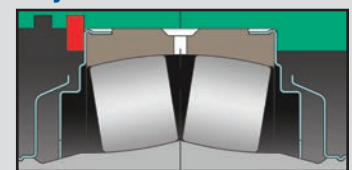

For higher speeds and temperatures, the IMPERIAL inserts offer labyrinth seals with corrosion-resistant flingers and a clearance steel seal carrier.

MOUNTED PLAIN



Baldor•Dodge offers a wide variety of plain bearings that are uniquely engineered to provide reliable performance – even in the harshest environments. Ideal for air handling, food processing, waste water, high temperature, and food & beverage applications, they feature patented technologies that reduce maintenance and ensure long service life.

Numerous designs allow you to select the best bearing style for any application – from a simple SOLIDLUBE® bearing to a SLEEVOIL® hydrodynamic externally cooled bearing.

In addition, our accessories, and circulating oil systems extend your value. Housings may be drilled and tapped to accept temperature, vibration and speed monitoring devices.

Baldor•Dodge Hydrodynamic Key Industries

- MINING / METALS
- AIR HANDLING
- CEMENT
- WOOD PRODUCTS
- AGGREGATE
- FOOD / BEVERAGE / PHARMACEUTICAL
- SUGAR
- POWER GENERATION



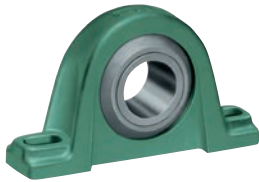

SOLIDLUBE® Sleeve Bearings

- Functions in harsh environments where ball bearing will not
- Self-lubricating, statically self aligning
- Covers a wide range of temperature extremes
 - 700 Series: -40°F to 700°F
 - 1000 Series: -200°F to -40°F and 250°F to 1000°F
- Housing types: 2-bolt pillow blocks, 4-bolt and 2-bolt flange units, and take-up units
- Ideal where bearings are subject to dry cycles or where lube systems would be too costly
- Bore sizes 3/4" to 8"



Babbitted & Bronze Bushed Bearings

- Good for slow speeds and shock loads
- Capable of MPTA load ratings
- Cast-iron housings in 2- and 4- bolt pillow blocks
- Babbitted bushed bearing features solid or fully split housing
- Bronze bushed bearing features fully split housing
- Bronze bushing is split and easily replaced



BRONZOIL®

- Feeds oil to shaft with self-oiling bushing
- Sleeve bearings with 2-piece pressed steel housing
- Statically self aligning
- Features bushing shoulder that provides self-lubricating bearing thrust face
- Designed with slotted bolt holes
- Available with oil-resistant rubber grommets for sound isolation and static electricity protection
- Housing types: 2-bolt pillow block and 4-bolt flange
- Bore sizes 1/2" to 1-1/4"



SLEEVOIL® RTL Series Hydrodynamic Pillow Block Bearings

- Extended life (no metal-to-metal contact during operation)
- Handles high speeds
- Dampens vibration, provides quiet operation
- Fully split for ease of maintenance
- Self aligning
- Three times the thrust load capability of R Series SLEEVOIL
- External cooling (air, water, or oil) available for hot shafts or high temperatures

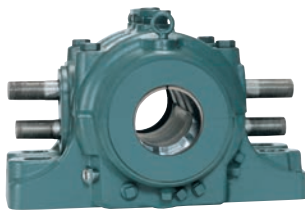

SLEEVOIL R Series Hydrodynamic Pillow Block Bearings

- Extended life (no metal-to-metal contact during operation)
- Handles high speeds
- Dampens vibration, provides quiet operation
- Fully split for ease of maintenance
- Self aligning
- Thrust capability
- External cooling (air, water, or oil) available for hot shafts



SLEEVOIL® Oil Level & Filtration System (OLF2)

- Maintains proper oil level while bearing is running
- Increases bearing performance and life
- Allows even oil distribution and cooler operating temperatures
- Ensures filtered clean oil
- Custom-engineered to support SLEEVOIL bearings

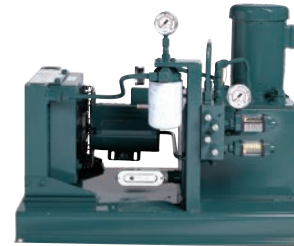

Cool Lube 2 System

- Designed for oil lubricated roller bearings
- Continuous:
 - Oil cooling
 - Oil filtration
 - Oil level control
- For bearing applications where bearing operating temperatures and speeds approach maximum permissible levels, or harsh & dirty environments



Polymer Sleeve Bearings

- Polymer housing contains additive that resists bacterial and fungal growth
- All polymer and stainless steel construction
- Solid polymer housing has no cavities and no fillings
- Conforms to FDA /USDA specifications
- Polymer sleeve insert with stainless steel anti-rotation pin
- No lubrication required, self-lubricated polymer sleeve insert for maintenance-free operation
- Offered in a wide variety of housing configurations and all popular bore sizes
- Operates in temperatures from -40°F to 180°F
- 3/4" - 1-15/16" bore size

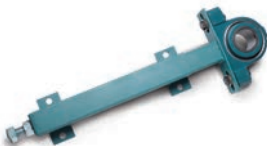

Take-Up Frames

- 6 take-up frame types available from stock
- Standard take-up frame travel from 1-1/2" to 60"
- Take-up frames allow for the mounting of Baldor•Dodge ball, roller, and sleeve bearings
- Take-up frame capacity is pre-engineered to exceed bearing capacity
- Made to provide/maintain tension and shaft centers on a variety of belt and chain-type conveyors
- Telescoping and wide slot take-up frames are available in stainless steel

TORQUE-ARM™ & TORQUE-ARM™ II



The Baldor•Dodge TORQUE-ARM II™ surpasses all other reducers on the market because of its industry proven design and patented features.

This powerful line of shaft mounted speed reducers – in 12 case sizes through 400 horsepower (HP) – offers unparalleled torque ratings and is quickly becoming the new industry standard. Improved features include: an all-new backstop concept, a patented

sealing system, a steel motor mount system, a state-of-the-art, totally modular design with an expanded ratio range to 40:1 and a patented twin tapered bushing system.

The increased ratings on the TORQUE-ARM II line are comparable to the next larger sized TXT reducer and are the result of the extended gear centers, wider gear faces and optimized tooth geometry. The new backstop design features centrifugal lift-off sprags for extended life and can be used with lubricants containing EP additives.

In addition, the TORQUE-ARM II line has a patented, premium sealing system that uses an HNBR oil seal protected by a metal excluder seal with rubbing lip. This harsh duty sealing system makes this reducer series a perfect fit for today's harsh duty industries such as aggregates, mining, cement, asphalt, mixing & milling and ethanol.

The new steel motor mount adjusts to multiple center distances and mounts in shaft mount and screw conveyor positions. Its patented twin tapered bushing system – in standard length, short shaft, and metric versions – offers all the features of our standard twin tapered TORQUE-ARM® bushing design which are unique to Baldor•Dodge. The patented insertable tapered wedge enables the optional extended tapered bushing kit to be applied for shorter shaft lengths; allowing the replacement of straight bore or single bushed reducers.

Both Torque-Arm II and Motorized Torque-Arm II are ATEX certified.

Motorized Torque-Arm has been found to comply with the Essential Health and Safety Requirements that relate to the design of Category 2 and M2 equipment, which is intended for use in potentially explosive atmospheres.

These Essential Health and Safety Requirements are given in Annex II to European Union Directive 94/9/EC of 23 March 1994.

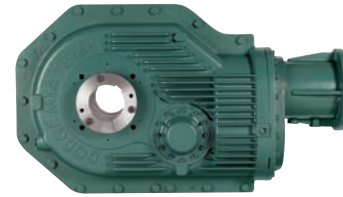

Motorized TORQUE-ARM II™ Shaft Mount Reducers

Heavy Duty Solution

- AGMA rated design offers longer life vs European DIN standards
- Straddle mount input pinion gives maximum torque throughput, no press-fit shank pinion
- Available in 3 Hp - 100 Hp based on output speeds
- Heavy duty HNBR lip seals for extended wear life and -40°F to +300°F
- Metal excluder shield sealing system with rubber contact lip
- Industry leading backstop design
- Three-piece coupled design
- ATEX certified

Installed Cost Savings

- Reduced assembly time & guarding costs
- Reduced maintenance requirements

Compact Flexible Drive Design

- Reducer mounts in multiple positions
- Two motor speeds and multiple gear ratios provide a wide spectrum of output speeds

Easy Selection

- Part numbered product concept
- Easy Class I & II selection tables

Proven Performance

- Rugged, high efficiency, case carburized helical/bevel gearing

Easy to Order

- C-face gear-motor option is delivered with Baldor motor assembled to gearbox

Capabilities & Mounting

- 7 reducer sizes with modular accessories
- Horsepower ratings through 100 HP
- Torque ratings through 130,000 lb-in
- Twin-tapered bushing bores through 4-7/16", metric bore sizes available
- All reducers can be shaft mounted, screw conveyor, vertical, and flange mounted

Accessories

- Tie rods
- Standard and short shaft bushing assemblies
- Backstops
- Screw conveyor adapters
- Screw conveyor drive shafts
- Standard Baldor•Reliance NEMA® C-face Motors
- Harsh duty accessories
- Optional metal or ABS bushing/end covers



Baldor•Dodge TORQUE-ARM® & TORQUE-ARM II™ Key Industries

- AGGREGATE / CEMENT
- MINING / METALS
- GRAIN/FOOD
- POWER GENERATION
- WASTE WATER





TORQUE-ARM II™ Shaft Mount Reducers

- Exclusive twin tapered bushings
- Rugged cast-iron efficient housing
- Highly efficient helical gearing
- Reliable anti-friction bearings and seals
- Efficient splash lubrication
- Meets or exceeds AGMA standards, including Class 1 - 5000 hours L10 life and 25,000 average hour life
- 100% factory noise and leak tested
- Heavy duty HNBR lip seals for extended wear life and -40°F to +300°F
- Metal excluder shield sealing system with rubber contact lip
- Smooth, rugged Class 30 cast-iron housings with pry slots
- ATEX certified

Capabilities & Mounting

- 12 reducer sizes with modular accessories
- Standard 5, 9, 15, 25, and up to 40:1 gear ratios
- Nearly 300:1 speed reduction with V-belt drives
- Horsepower ratings through 400 HP
- Torque ratings through 500,000 lb-in
- Twin-tapered bushing bores: 1" through 7", metric bore sizes available
- All reducers can be shaft mounted, screw conveyor, vertical, and flange mounted

Accessories

- Tie rods
- Motor mounts
- Standard and short shaft bushing assemblies
- Belt guards
- Backstops
- Screw conveyor adapters
- Screw conveyor drive shafts
- Auxiliary seal kits
- Cooling fans
- Harsh duty accessories

TXT TORQUE-ARM® Shaft Mount Reducers

- Exclusive twin tapered bushings
- Rugged cast-iron efficient housing
- Precision, high-quality helical gearing
- Reliable anti-friction bearings and seals
- Efficient splash lubrication
- Meets/exceeds AGMA standards
- 100% factory noise and leak tested

Capabilities & Mounting

- Standard ratios: 5, 9, 15, and 25:1
- Ratios up to 210:1 with V-belts
- Fractional to 700 HP
- Output speeds through 400 RPM
- Flange mount and vertical shaft options
- Available with hydraulic motor input

Accessories

- Motor mounts
- Bushing assemblies
- Backstops
- Auxiliary seal kits
- Belt guards
- Cooling fans
- Harsh duty accessories

SCXT Screw Conveyor Shaft Mount Reducers

- Industry standard, high quality, drive mounting
- Adapter conforms to any CEMA trough ends
- Sealing system alternatives in standard adapter
- Waste packing & braided felt seals
- Rugged, high-thrust roller bearings
- Conforms to CEMA standards
- CEMA high-strength shafts, 2- and 3-bolt

Capabilities

- Fractional to 75 HP
- Standard ratios: 5, 9, 15, and 25:1
- 1-1/2" to 3-7/16" CEMA drive shafts
- Output speeds through 400 RPM
- Available with hydraulic motor input
- Vertical and incline mounting capability

Accessories

- Standard C and AC adapters
- Drive shafts - standard and stainless steel
- Motor mounts
- Belt guards
- Auxiliary seal kits
- Cooling fans

TA II Modular Concept

Shaft mounted reducer with twin-tapered bushing and motor mount



Screw conveyor drive with adapter, drive shaft and motor mount

MTA II Modular Concept

Motorized Shaft mounted reducer with twin-tapered bushing



Motorized Screw Conveyor drive with adapter and driveshaft



Modular Accessories

- **Standard Twin-Tapered Bushing System** is an easy on, easy off, no-wobble bushing system featuring a fully split, ductile iron 8° taper and reliable twin support. Available in inch and metric bores. Increased bore capability in many sizes.



- **Short Shaft Twin-Tapered Bushing Kits** (Patent numbers 5,667,333 and 5,951,198) eliminate the need for full-length shafts. Constructed with ductile iron, it has all the features of our standard bushing system. Available in both inch and metric bores.



- **Modular Motor Mount** is attached and supported by two angle iron brackets with equally spaced holes, which align with the spacing of the cast slots of the gear case. This way, the motor mount can be adjusted up or down depending on the customer's requirements. It can also be mounted on the side of the reducer for screw conveyor applications.



- **Backstop** option helps prevent reverse rotation in high stop-start loads, and results in less wear and longer life. Its centrifugal throw-out design eliminates sprag sliding and reduces wear. It operates with standard and EP lubricants and requires no external lubrication.



- **TA Rod Kit**, including standard brackets, functions as a belt-tensioning device, and offers universal mounting options.



- The **CEMA Bolt-On Adapter** features double-lip seals on both surfaces. The adapter center is open for contaminate drop out for optimized sealing.



- **Adjustable Packaging Adapter Kit** bolts to the standard adapter and provides a proven sealing option for hostile environments. Packing can be retightened.
- **Screw Conveyor Drive Shafts** are made from high alloy steel and engineered to

CEMA dimensions. They are three-bolt drilled and their tapered fit ensures simple installation. The rugged locking plate (patent pending) also provides a mechanical shaft removal feature.



- **Bolt-On Belt Guard Package** requires no drilling or straps. It allows multiple height adjustments, features a lift-off cover construction, and has an open metal inspection feature.
- **Other accessories include: cooling fans, v-ring flinger seal kits, TDNC bushing kits, and vertical breather kits.**



TIGEAR-2®



Never before have greater advancements been made in speed reducer technology.

Our family of Baldor•Dodge TIGEAR-2® speed reducers is the only complete line of single-reduction, right-angle worm speed reducers specifically engineered with sealing and bushing system technology that can actually lower your total cost of ownership.

Nothing comes close to this technology because almost every component in each reducer is either new or dramatically improved from the previous design. Its gear geometry is optimized for 30% higher torque, greater efficiency, and cooler operating temperatures. Its sealing system has no pressure vent and no compression chamber. It comes with a factory-filled synthetic lubricant that needs no routine oil changes. Plus, by adding the Baldor•Dodge GRIP TIGHT® adapter, we have the industry's only tapered bushing system with easy-on, easy-off installation and removal.

In terms of greater cost savings, extended life, and maintenance-free operation, there's no competition.



TIGEAR-2® Speed Reducers

- Single-worm with quill, separate or 3-piece coupled input
- Totally enclosed, ventless design that is maintenance free
- 10 case sizes 1.33" to 4.75" center distances
- 5:1 to 60:1 reductions
- Higher torque ratings than competition
- Solid or hollow output
- GRIP TIGHT bushing system available
- E-Z KLEEN® & ULTRA KLEEN® stainless steel design available
- Cast iron construction that is durable and corrosion resistant
- Factory filled with synthetic lubricant

Baldor•Dodge TIGEAR-2 Key Industries

- FOOD & BEVERAGE
- UNIT HANDLING
- BAGGAGE HANDLING
- AUTOMOTIVE INDUSTRY
- PACKAGING

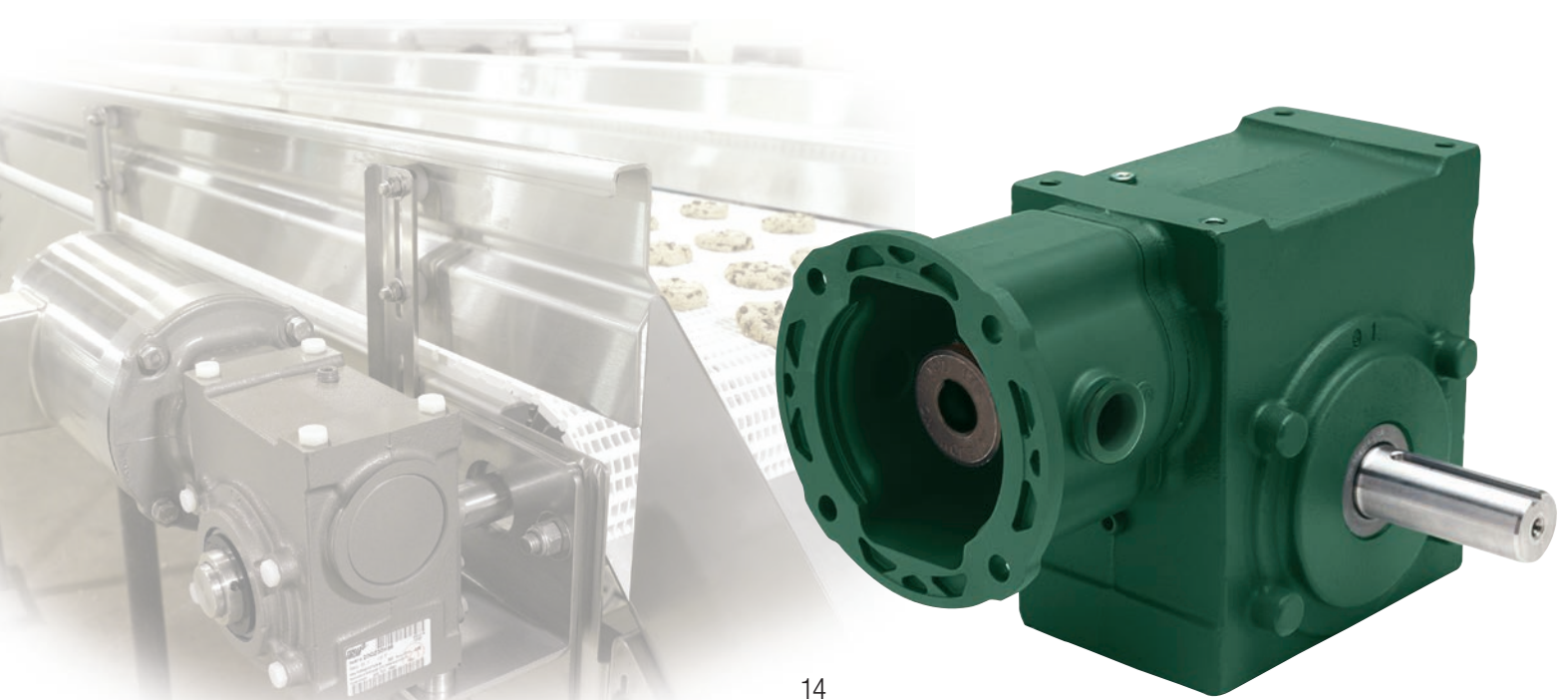

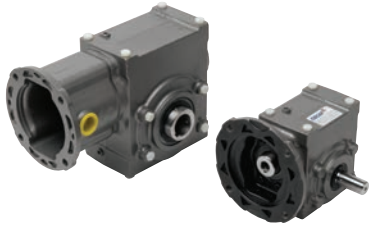

Tigear-2® E-Z KLEEN® Reducers

For maximum washdown protection, the Baldor•Dodge TIGEAR-2® reducer is also available in E-Z KLEEN® models with features never before offered in washdown reducers. These reducers are manufactured with a 13-step coating system that provides more than three times the corrosion resistance of standard epoxy-painted units. And, to ensure that their interior is as protected as their exterior, the Baldor•Dodge TIGEAR-2 E-Z KLEEN reducers have a two-piece, harsh-duty sealing system that protects against high-pressure sprays and sanitizing solutions. Other standard features include stainless steel solid or hollow output shafts and stainless hardware.

TIGEAR-2 E-Z KLEEN reducers are factory filled with an H1 food grade synthetic lubricant that never needs changing, and are available in sizes 13 – 35 with quill or three-piece coupled input, and solid or hollow output configurations.

WASHDOWN ACCESSORIES

- Stainless-steel GRIP TIGHT bushings
- Stainless steel straight bore bushings
- Bolt-on base kit
- Riser block kit
- J-mount base kit
- Output flange kit



Tigear-2® ULTRA KLEEN® Reducers

The best choice for a stainless steel reducer with ultimate washdown protection or where “paint free” specification is required.

STANDARD FEATURES INCLUDE:

- Premium 316 stainless steel housings
- Stainless steel solid and hollow output shafts and stainless hardware
- Two-piece harsh duty output seals
- Factory filled H1 food grade synthetic lubrication
- Available in sizes 17, 21, 23, 26 and 30 with quill or 3-piece coupled input and solid or hollow output configurations.
- Washdown Accessories include:
 - Stainless steel GRIP TIGHT bushings
 - Stainless steel straight bore bushings
 - Stainless steel bolt-on base kit
 - Stainless steel output flange kit

TWO-PIECE HARSH DUTY OUTPUT SEAL:

- Tigear-2 washdown reducers have a 2-piece harsh duty sealing system that protects against high-pressure sprays and sanitizing solutions.



CONFIGURATION OPTIONS

The advanced design concept of the TIGEAR-2 reducer product line provides extreme flexibility for applications that require from 100 to more than 6,500 lb-in of torque. Whether the application requires the compactness of a quill-style input, the durability of a three-piece coupled input, or a separate keyed input shaft for belt-driven equipment, TIGEAR-2 is the answer. With three basic reducer configurations that are dimensionally interchangeable with most competitive brands and bolt-on accessories, the TIGEAR-2 reducer line is truly a complete line that is full of value.

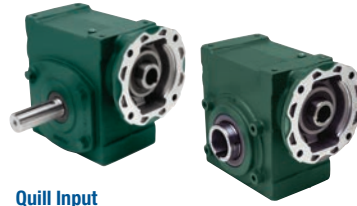

Quill Input

Space-saving quill-style input reducers are available for NEMA C-face motors in both solid and hollow output designs.

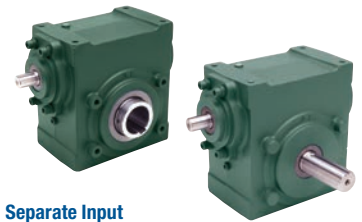

Separate Input

Separate style input reducers with solid or hollow output shafts are suitable for either belted or direct-coupled motor connections.



Three-Piece Coupled Input

Attaching a stock, three-piece coupled motor adapter kit to a separate style reducer creates a durable drive package that facilitates easy motor removal and provides protection against shock loads and other unpredictable vibrations.

ADVANCEMENTS THAT LOWER YOUR TOTAL COST OF OWNERSHIP

BUSHING KIT

With the new easy on, easy off GRIP TIGHT® tapered bushing system, there are no loose fasteners to misplace during installation, and the locking nut creates a positive means for easy removal.



HELICAL ATTACHMENT

- Easily attaches to a TIGEAR-2® reducer with 56C and 140TC quill or 3-piece coupled input
- NEMA 56C or 140TC input and 56C or 140TC output
- Available in 4:1 and 5:1 ratios
- Factory filled with food grade synthetic oil
- Lubed for life
- No breather
- Suitable for all mounting positions right out of the box
- Rugged cast iron construction

QUANTIS® – ILH/MSM/RHB

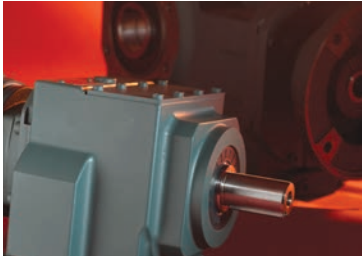

The Baldor•Dodge QUANTIS® product line offers a full line of modular gear drives engineered for flexibility, greater torque density in a compact housing configuration, and increased horsepower capability from 1/4 HP to 75 HP.

The QUANTIS family of products offers the customer three types of gear reducers: in-line helical (ILH), right angle helical bevel (RHB) and motorized shaft mount (MSM).

All three types of reducers are dimensionally interchangeable with major global competitors.



QUANTIS® E-Z KLEEN

Quantis E-Z Kleen is offered in five sizes: 38, 48, 68, 88, and 108 for both ILH, RHB, and MSM housing styles. Either the clamp collar or the 3-piece coupled input is available for mounting a c-face motor.

E-Z Kleen Features:

- Unique coating system provides greater than three times the corrosion resistance of standard epoxy paint
- White or stainless steel color top coat
- XT Harsh Duty output seal features nitrile and a quadra-lip design material
- Thin Dense Nickel Composite (TDNC) plated output shafts
- Non-cavity Hardware
- Factory filled with mineral, synthetic, or Food Grade USDA H-1 lubrication
- Water tight gasket on c-face input between motor and reducer
- One way washdown spring loaded breather

E-Z Kleen Accessories

- TDNC Twin Tapered Bushings (inch or Metric)
- E-Z Kleen Tie Rod Kit
- E-Z Kleen Torque Arm Bracket
- E-Z Kleen B5 Flange Output Bracket



QUANTIS® ULTRA KLEEN

Quantis Ultra Kleen is available in two sizes: 38 and 48 in the RHB housing style. Clamp collar is available for mounting a c-face motor.

Ultra Kleen Features:

- Manufactured of 316 grade stainless steel
- Universal housing for foot or flange mounting
- Clamp collar size options: 56C, 140TC, and 180TC
- Output options: Single Extension Solid, Straight Hollow Bore, and Q-Loc Keyless
- Food Grade USDA H-1 Lubrication or synthetic
- XT Harsh Duty output seal features nitrile and a quadra-lip design material
- Breather free operation
- Laser etched nameplate

Ultra Kleen Accessory

- Q-Loc Keyless bushing kit in stainless steel

MSM – Motorized Shaft Mount



RHB – Right Angle Helical Bevel

ILH – In-Line Helical

QUANTIS® ILH, MSM and RHB C-FACE REDUCERS / INTEGRAL GEARMOTORS – STANDARD AND OPTIONAL FEATURES

- Available in Right Angle Helical Bevel (RHB), In-Line Helical (ILH), and Motorized Shaft Mount (MSM) configurations.
- Eight sizes (38 through 168)
- Four input configurations including integral motor, c-face clamp collar, three piece coupled c-face motor adapter, and separate input shaft.
- Case carbonized gearing insures longer life to reduce unscheduled downtime.
- ILH and MSM are 98% efficient per stage of reduction
- RHB is 94% efficient
- Designed to achieve greater output torque ratings, increased horsepower ratings and expanded ratio range
- Two housing designs – foot mounted and flange mounted
- Multiple output shaft options in both inch and metric
- Factory filled with oil prior to shipment
- Integral motors – inverter capable
- Standard Integral motors are IP55 enclosure. Integral brake motors are IP54.



QUANTIS®	SIZES	OUTPUT TORQUE RANGE
ILH	ILH 38 - 168	116 in-lb - 123914 in-lb
MSM	MSM 38 - 168	712 in-lb - 118603 in-lb
RHB	RHB 38 - 168	411 in-lb - 119556 in-lb



Input Modular Options

- Clamp Collar
 - NEMA 56C - 360TC
 - IEC 71D - 200D
- 3 Piece Coupled
 - NEMA 56C -360TC
 - IEC 80D - 250D
- Integral Gearmotor
 - 1/4 HP - 10 HP
- Separate Input

Output Options

- Solid output shafts
 - ILH, RHB, MSM
- Hollow bore
 - RHB, MSM
- Twin-tapered bushings
 - RHB, MSM
- Double shaft
 - RHB
- Shrink disk
 - RHB, MSM
- Q-Loc keyless bushing
 - RHB, MSM

Baldor•Dodge QUANTIS® Key Industries

- FOOD & BEVERAGE
- PACKAGE HANDLING
- FOREST / PAPER
- HVAC / INDUSTRIAL AIR HANDLING

QUANTIS® Accessories

STANDARD TWIN-TAPERED BUSHING KIT

An easy on, easy off, no wobble bushing system featuring a fully split, ductile iron 8-degree taper and reliable twin support. Available in inch and metric bores.



SHORT SHAFT BUSHING KITS

Eliminate the need for full length shafts. Constructed with ductile iron, it has all the features of our standard bushing system. Available in both inch and metric bores.



BACKSTOP OPTION

Helps prevent reverse rotation in high stop-start loads, and results in less wear and longer life. It's centrifugal throw out design eliminates sprag sliding and reduces wear. It operates with standard and EP lubricants and requires no external lubrication. For use with three piece coupling and separate inputs.



XT-HARSH DUTY OUTPUT SEAL

The rubber coated nitrile output seal consists of 2 parts; the inner sleeve and outer sleeve. The vertical flange of the inner sleeve protects the lip from high pressure washdown spray and the outer sleeve holds the actual lip. Two additional dirt excluder lips help to fling dirt away and provide a labyrinth.



CEMA ADJUSTABLE ADAPTER ASSEMBLY

The RHB & MSM screw conveyor adapter assembly is available with two options, standard and harsh duty. The standard option includes the adapter with bolts, two double lip seals and hardware. The harsh duty option includes the adapter with bolts, two double lip seals, packing retainer, three braided seals and hardware.



CEMA SCREW CONVEYOR DRIVE SHAFT

Screw conveyor drive shafts are made from high alloy steel material, designed with three bolt holes and engineered to CEMA dimensions. The screw conveyor drive shaft connects to either the RHB or MSM straight hollow bore reducer with the keeper plate and bolt assembly.



MSM RUBBER BUSHING KIT

For MSM Shaft Mounted Applications. The MSM rubber bushing is recommended to protect the unit from shock loads.



RHB TORQUE ARM BRACKET

For RHB shaft mounted applications using the "BF" Style Housing. The RHB torque arm bracket includes the bracket and hardware.



RHB TIE ROD KIT

RHB tie rod kit includes mounting bracket, adjustable length torque arm and fulcrum with fasteners. Utilizing the "BF" Style Housing.



ILH ADJUSTABLE SLIDE BASES

Positions the reducer, providing simplified installation and servicing of the belt and chain drives. Position changes to obtain the desired belt or chain tension are easily accomplished by using the supplied adjusting screw.



RATIO RANGE	INPUT MOTOR POWER RANGE	MOTOR ADAPTERS
1.41:1 - 359:1	1/4 HP - 75 HP	NEMA 56C - 360TC IEC 71D - 250D
6.65:1 - 350:1	1/4 HP - 75 HP	NEMA 56C - 360TC IEC 71D - 250D
4.83:1 - 307:1	1/4 HP - 75 HP	NEMA 56C - 360TC IEC 71D - 250D



With Baldor•Dodge CST® drives, you get consistent, controlled starts and stops regardless of varying load or ambient conditions. On long conveyors employing multiple drive systems, CST offers excellent load share, torque limiting characteristics, and maximum motor power availability throughout the controlled speed profile.

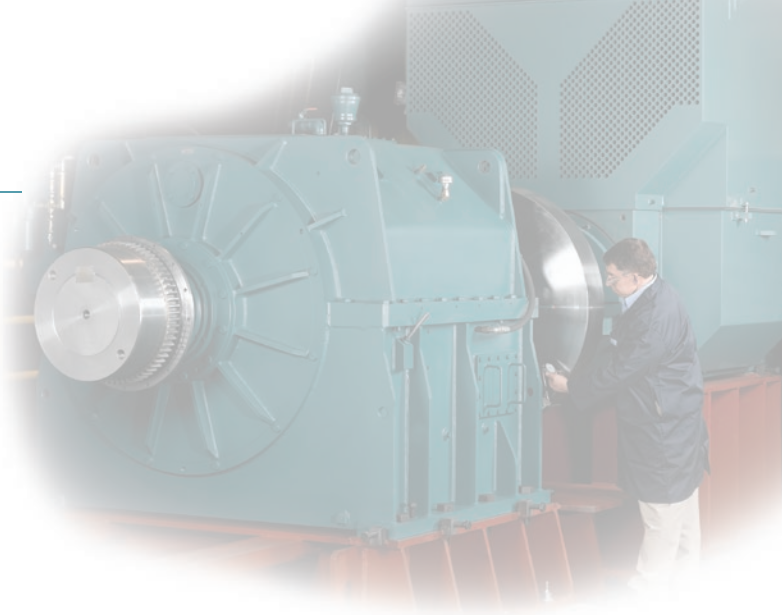

System Features

Controlled Acceleration & Deceleration Ramps

- Parabolic starting curves
- Adjustable acceleration times
- Deceleration (not braking) ramps

Multiple Starting Duty

- Cooling system designed for repeated starts
- Drive motor may be left running between starts

System Benefits

Power Grid

- Minimizes voltage drops via sequenced motor starts where multiple drives are utilized
- kW demand reduced by unloaded motor starts

Motor

- No load starts
- Frequent motor starts eliminated
- Utilize up to breakdown torque of motor, when needed, without oversizing

Gearing

- Protected from shocks by clutch mechanism
- Efficient planetary design

Conveyor Components

- Hydro-viscous clutch located at output of the CST absorbs transient shocks
- Parabolic acceleration ramp minimizes belt and pulley stresses
- Complete Project Capabilities

Baldor•Dodge CST Key Industries

- MINING
- AGGREGATE
- CEMENT

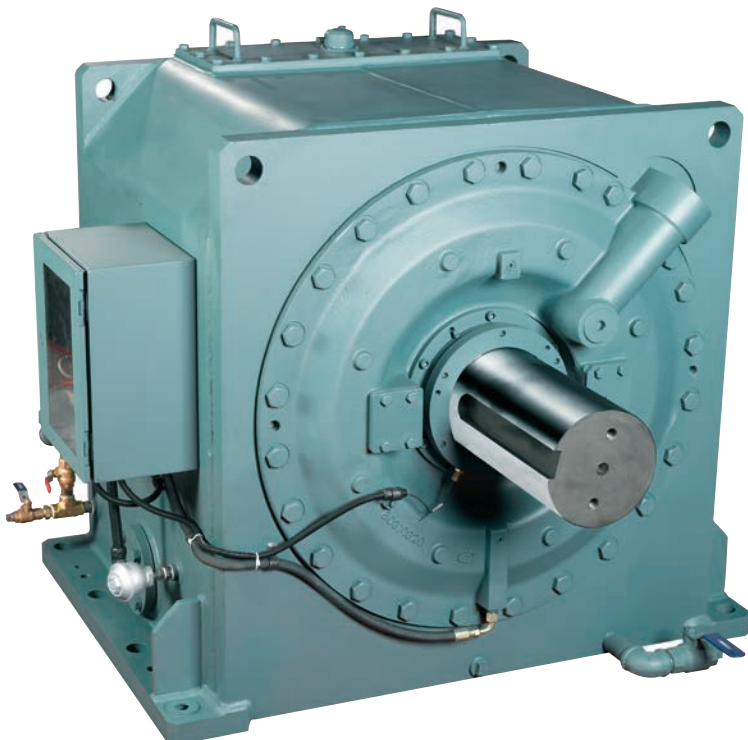

CSB

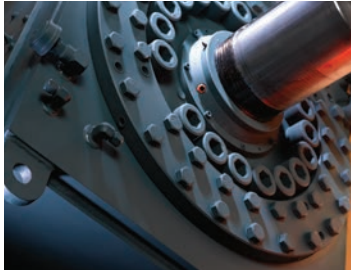

Baldor•Dodge Controlled Stop Brake – CSB

The Baldor•Dodge CSB is a heavy-duty, fast reaction, brake and retarding device for service when constant or repeated braking exceed the capabilities of conventional dry disk brake systems. The CSB design is based on the unsurpassed hydroviscous clutch technology utilized in the Baldor•Dodge CST® product line and provides continuous braking capacities exceeding 1,500,000 in-lb of torque. The CSB provides the most precise continuous control available for decelerating decline conveyors.

System Features

- Rugged design to assure reliability in tough applications
- External cooling sized for continuous operation from zero to over 1,500,000 in-lbs of torque.
- Fail safe operation in the event of power loss
- Can be connected to a pulley shaft as a stand-alone brake
- Can be connected between reducer and pulley
- Can be used as a backup device to prevent overloads on regenerative drives
- System includes condition monitoring for the CSB
- Control through simple PLC programming
- Sealing system designed for harsh conditions

System Benefits

- Eliminates concerns with overheating of conventional brake system
- Allows unlimited starts and stops
- Precisely controlled deceleration ramps
- Can be packaged with base and couplings
- Provides the exact amount of braking required for any point in time
- Hydro-viscous clutch located at output of the CSB absorbs transient shocks
- Parabolic acceleration ramp minimizes belt and pulley stresses
- Complete Project Capabilities

Baldor•Dodge CSB Key Industries

- MINING
- AGGREGATE
- CEMENT



MAGNA GEAR XTR[®]



The MagnaGear XTR™ reducer is manufactured to provide maximum reliability in tough applications and to improve your total cost of ownership. The innovative design incorporates state of the art technology to meet the high standards expected of Baldor•Dodge reducers. MagnaGear XTR provides the perfect solution for your high torque application needs.



Versatile Performance

- Parallel shaft or right angle configurations are available
- Torque capacities from 100,000 in-lb to 3,500,000 in-lb
- Available in solid or hollow shaft output
- Global product design to fit all markets
- Modular design for reversibility and multiple mounting configurations
 - Minimizes spare requirements
 - 4-sided mounting configurations
- Can be used with a variety of soft start mechanisms including VFD and fluid couplings
- Multiple mounting configurations are available
 - Base mounting
 - Swing base mounting
 - Tunnel housings

Rugged Design

- Designed to meet or exceed AGMA and international standards
- Gearing is carburized, hardened, and precision ground
- Premium tandem taconite seal system is standard with HNBR oil seal protected by a contact excluder lip seal and grease cavity
- All bearings exceed AGMA standards for L10 life
- Versatile cast iron housings

Design Considerations

- Focus on rugged, heavy duty design for maximum reliability
- Power dense design
- Components are power matched for optimum performance at a lower installed cost
- Proven planetary design is utilized in sizes over 390,000 in-lb to provide a compact, durable, light weight, economic solution for high torque applications
- Proven premium sealing system

Engineered Accessories

A complete line of engineered accessories including:

- Internal lift-off style backstops
- Shaft fans
- Electric fans
- Moment couplings
- Swing base mounts
- Torque arms
- Tunnel drive alignment free configurations
- Baseplates



DM Moment Couplings

- Engineered to transmit torque and support the bending moment forces of an entire gearbox drive package
- Male and female piloted hubs manufactured from 4140 alloy steel
- Grade 8 bolts
- Accommodates up to 3,500,000 in-lbs torque



Baldor•Dodge MagnaGearXTR Key Industries

- MINING
- AGGREGATE / CEMENT
- GRAIN HANDLING
- POWER GENERATION
- SUGAR
- PAPER & FOREST PRODUCTS

MAXUM[®] XTR



The Baldor•Dodge MAXUM[®] XTR concentric reducer is a rugged, compact design that generates dependable performance in less space. The housings are made of high strength ductile iron which is necessary for industrial applications. The reducers overhung load capability is also optimized for total system value.



MAXUM XTR Concentric Speed Reducers

- Compact, power-dense design
- Precision-machined, ductile iron housings
- Highly efficient AGMA-rated helical gearing
- Heavy duty tapered roller bearing design meets or exceeds AGMA standards
- Full line of accessories available
- Premium tandem seal system is standard, with HNBR oil seal protected by a contact excluder lip seal and grease cavity

Features

- 9 sizes
- Fractional to 1600 HP
- Ratios: 2.25 to 194.6
- Up to 579,000 (in-lb) torque
- Mounting flexibility
- Direct coupled
- Top mount
- Scoop mount
- Heavy duty base plate

Accessories

- Backstops
- Slide base
- Cooling fans
- Heat exchanger cooling package
- XT filter breather
- XT enclosed breather
- Coupling and belt guards
- Oil sight gauge

Baldor•Dodge MAXUM XTR Key Industries

- MINING
- AGGREGATE / CEMENT
- GRAIN HANDLING
- POWER GENERATION
- SUGAR
- METALS
- PAPER & FOREST PRODUCTS



COUPLINGS



Uniquely engineered to dampen vibration, accommodate shaft misalignment, and eliminate unexpected downtime.

Baldor•Dodge® has manufactured couplings for over 100 years and has earned a reputation for developing innovative products that lower customers' total cost of ownership.

The Baldor•Dodge® coupling product line can offer a solution to almost any customer need. Whether the need is an elastomeric or metallic design, Dodge can provide a coupling with the potential to increase torque capacity, accommodate shaft misalignment, eliminate lubrication, extend life, improve application efficiency, and put an end to unexpected downtime.

Baldor•Dodge® offers complete system packages containing a variety of designs, sizes, and options. The large product offering allows pump, conveyor, and fan users to have a drive, motor, coupling, gearbox, bearings, and conveyor pulley from the same manufacturer. The ability to provide a single source system design with the product breadth and depth of Baldor•Dodge® is an advantage shared with no other manufacturer in the marketplace.



PARA-FLEX®

- Industry leading misalignment (4° angular, 1/8" parallel, and 5/16" end float)
- Industry leading 5-year warranty
- TAPER-LOCK, QD, ductile iron FBX finished bore, and steel BBS bored-to-size flanges
- Elements available in natural rubber, neoprene, and cordless
- Fast installation on misaligned shafts
- Accommodates up to 8" bores and 453,000 in-lbs of torque
- ATEX certified



D-FLEX®

- Three-way flexing action handles shock, vibration, and misalignment
- Available in Type J, S, B, and SC spacer flanges
- Sleeves available in EPDM, Neoprene, and Hytrel
- AGMA 9 dynamically balanced Type S and SC flanges
- Accommodates up to 6" bores a 72,480 in-lbs of torque
- ATEX certified



GRID-LIGN®

- Flexible tapered grid isolates vibrations and cushions shock loads
- Available in close-coupled, T31 full spacer, or T35 half-spacer designs through size 1200T
- Spacer designs can be used with brake discs or drums
- Accommodates up to 13" bores, and 1,650,665 in-lbs of torque
- S-Series offers torque capabilities through 7,000,000 in-lbs



Dodge Disc Coupling

- Dodge's unique dual-scalloped disc geometry allows for industry leading torque capacity and misalignment capabilities
- API 610 design standard, API 671 available upon request
- Large hub option offers increased bore capacities, and potential to downsize coupling
- Accommodates up to 15.25" bores and 2,292,000 in-lbs of torque
- ATEX certified



GEAR

- Most power dense coupling DODGE offers
- Interchangeable with industry standard AGMA gear couplings through size 9
- Spacer, floating shaft, slide gear, and other highly customizable designs
- Accommodates up to 42" and 47,269,000 in-lbs of torque





TAPER-LOCK® RIGID

- TAPER-LOCK bushing connects varying diameter shaft sizes
- Flanges are all machined, and require no maintenance
- Accommodates up to 6" bores and 254,500 in. lbs.

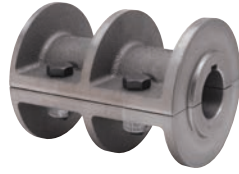

RIBBED RIGID

- Rated load capacities of 1018 Shafting
- Connects same diameter shafts via compression fit clamping
- Accommodates up to 7" bores and 404,000 in. lbs.



PARA-FLEX® FLYWHEEL

- Flexible element connects to standard SAE flywheel bolt patterns
- SAE bolt circle diameters from 8-3/4" to 25-1/4"
- Accommodates up to 6-7/8" bores and 85,050 in. lbs.



POLY-DISC®

- Polyurethane flexible disc resists chemical attack
- Allows 2° of angular misalignment & cushions shock loads
- Accommodates up to 3-1/4" bores and 10,900 in. lbs.



CHAIN

- Available with reborable, finished bore or TAPER-LOCK® flanges
- Compact design offers high torque capability
- Accommodates up to 4-11/16" bores and 1,273 HP applications



FLUID (Coupling)

- Mechanical soft start dampens shock load and reduces motor current draw
- Available in standard, single, and double delay fill
- Available in drive style (sheave), and coupling style (PARA-FLEX & Gear)
- Accommodates up to 4.75" bores and 1400 HP applications



FLEXIDYNE®

- Mechanical soft start via flow charge (cast steel pellets) fill
- 100% efficient, no slippage
- Available in three designs: Drive, Coupling and C-flex
- Accommodates up to 4.5" shaft and 250 HP applications



DM MOMENT

- Engineered to transmit torque and support the bending moment forces of an entire gearbox drive package
- Male and female piloted hubs manufactured from 4140 alloy steel
- Grade 8 bolts
- Accommodates up to 15" bores and 2,100,000 in-lbs torque

Baldor•Dodge Couplings Industries

- PUMPING
- MINING / METALS
- AGGREGATE / CEMENT
- PETRO / CHEM
- FOOD
- FOREST / PAPER PRODUCTS
- HVAC / INDUSTRIAL AIR HANDLING
- UNIT / BAGGAGE HANDLING
- POWER GENERATION
- SUGAR

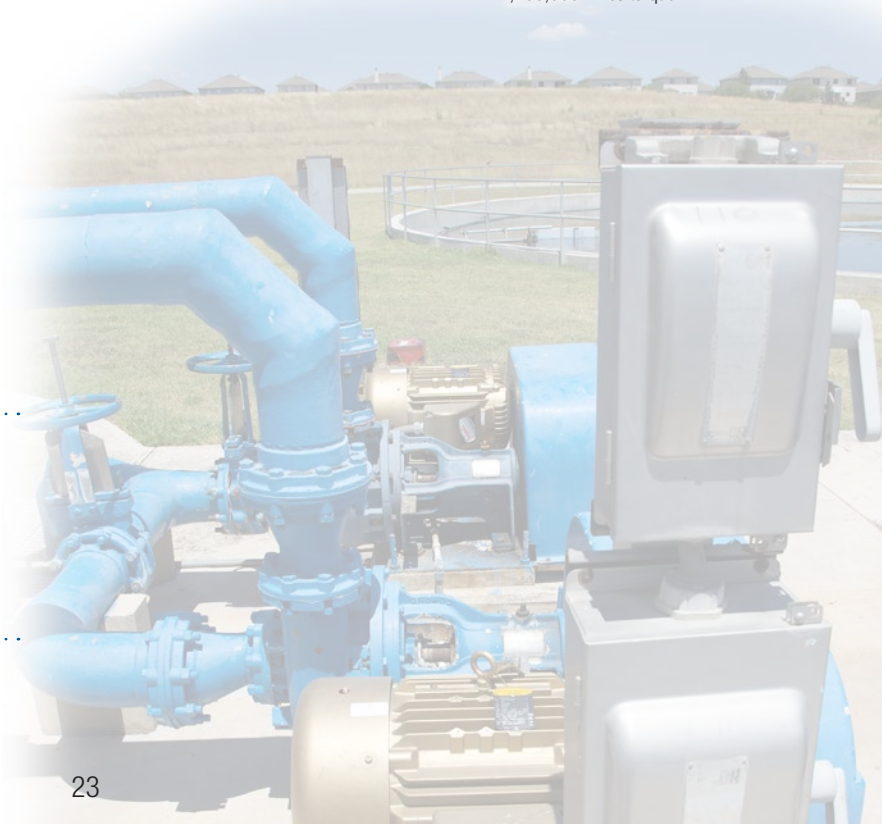

DRIVE COMPONENTS



For decades, Baldor•Dodge power transmission products have advanced the standards in industry – affecting and improving the way the world transfers power. Essential elements of power transmission are Baldor•Dodge mechanical drive components: V-belt drives, synchronous drives, and roller chain drives. These rugged products not only connect one driven shaft to another, but they isolate shock load and vibration, correct minor misalignment, synchronize movement between shafts, and offer energy efficiency.



Diamond D Integral Key Taper

- Popular bore sizes
- Capitalizes on proven Baldor•Dodge sintered steel technology
- No more fumbling with a separate key and setscrew over the key, integral key cannot work loose or fall out.
- Clearances between key and bushing are automatically eliminated, providing a more precise fit. Provides full key even in maximum bore sizes. No more “shallow keyseat” compromise.
- Eliminates labor cost associated with installing key and separate key, and associated inventory expense.
- Integral key concept thoroughly analyzed, including computerized Finite Element Analysis (FEA), for stress evaluation.
- Extensive laboratory testing included static and dynamic loading on customized machinery. Results demonstrated in successful field applications.



Bushings

- Full line of TAPER-LOCK® and QD available
- Stock sizes available up to 12” shaft diameter
- Material: sintered steel, cast iron, ductile iron, steel and stainless steel
- Easy installation and demounting
- Inch and metric bores
- GRIP TIGHT®



Accessories

- Type A, Type B and Adjustable NEMA Motor Bases (Light to Heavy Duty)
- Motor Bases are fabricated of steel which offers a base of rugged design, compact and smooth in appearance
- Type B Heavy Duty bases can hold a foot mounted gear reducer
- Bases are tapped to receive popular NEMA frames and can be tapped on order for others by specifying the frame size required
- Shaft Collars are used to accommodate components on power transmission application; they are available in solid steel and solid iron. A split option is available in iron.



Weld-On Hubs

- Full line of TAPER-LOCK and QD available
- Steel material with rugged, compact designs
- Hubs to accommodate most bushing sizes
- Made-to-order capabilities – special construction and materials



V-Belts

- Full range of Classical (A, B, and C) and D-V Wedge (3V, 5V, and 8V) belts
- Manufactured to RMA standards
- Polyband, Double-V (hex), and FHP belts available
- Lengths from 22” to 660”
- Drive capability from 1 HP to over 1000 HP



V-Belt Sheaves

- Full line of TAPER-LOCK and QD available
- Classical (A,B, and C) and D –V Wedge style (3V, 5V, and 8V) groove profiles. Poly-V and Flat face pulleys are also offered.
- Stock sizes from one to 12 grooves and 1.5” to 71” in diameter
- Manufactured to MPTA standards
- Made-to-order capabilities – material, construction, BTS, etc.
- Computer drive selection available

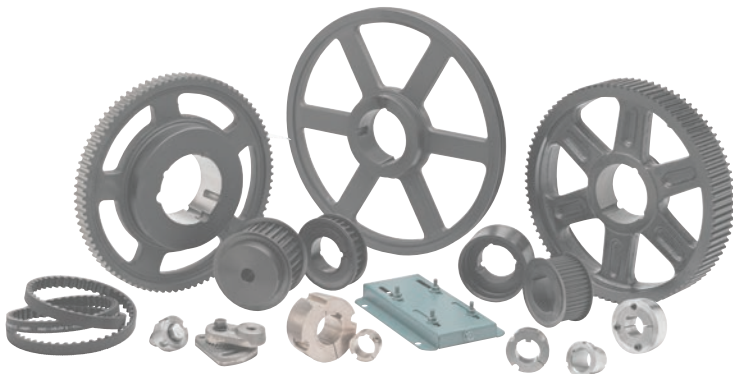

Baldor•Dodge Drive Components Key Industries

- UNIT HANDLING
- FOREST & PAPER
- FOOD & BEVERAGE
- AIR HANDLING
- MINING
- FLUID HANDLING
- PETRO / CHEM
- AGGREGATE
- CEMENT
- SUGAR



High Torque “HT500” Sprockets

- 98% Efficient Drive System
- Metric Pitch: 8mm and 14mm
- Modified Curvilinear Tooth Profile, operates with High Torque Dodge HT500 belts made with carbon fiber cords
- Fractional to 1,500+ HP
- Made-To-Order: Cast Iron, Ductile Iron, Steel, Stainless Steel & Aluminum construction. Taper-Lock, , QD, Split-Tapered & Finished bores. Zinc & Nickel plating available.



HT/HTD Synchronous Belt Drives

- Full line of TAPER-LOCK®, QD, and minimum plain bore sprockets
- Higher capacity drives
- Available pitches: 5 mm, 8 mm, 14 mm and 20 mm
- Made-to-order sprocket capabilities: construction, non-standard number of teeth, etc.
- Various tooth profiles available
- Computer drive selection available



Synchronous Belts

- HT500 – Modified Curvilinear Tooth Profile - polyurethane with carbon fiber tension cords and a carbon black nylon tooth facing
- HT200 – Modified Curvilinear Tooth Profile – Fiberglass cords
- HTD: Curvilinear Tooth Profile – Fiberglass cords
- Dyna-Sync: Trapezoidal Tooth Profile – Fiberglass cords

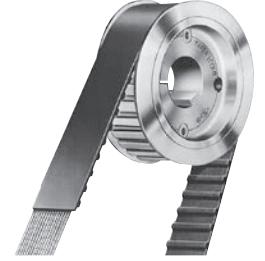

Timing Drives – Dyna-Synch

- Clean Compact Taper-Lock design
- Precision Manufactured ISO 9000 certified plant
- Flanged design standard on Driver Sizes
- No lubrication required
- Low maintenance, the original timing drive.



Roller Chain Drives

- Sprockets manufactured to ANSI standard
- TAPER-LOCK sprockets: #35 (1/8" pitch) to #160 (2" pitch)
- Double-strand, double-single, and reborable sprockets also available
- Special machining and rebore capabilities available through MTO
- Accessories available: idlers, tensioners, etc.
- Hardened teeth up to 25 teeth on #40 through #160 sprockets
- Chain tools available



Idler Brackets and Bushings

- Double Adjustable Bracket for Maximum Flexibility
- Positive Ratchet Locking Between Base and Arm
- Idler Bushings in TAPER-LOCK® and QD* Style
- Use with Stock Products, such as: Sheaves, Roller Chain Sprockets, Synchronous Sprockets
- Compatible with Products Machined for: TAPER-LOCK 1610, 2012 and 2517 Bushings; QD SK, SF and E Bushings

* QD is a registered trademark of Emerson Electric



Benefits of Synchronous Drives vs. V-Belt Drives

- 5% or more energy efficient
- More torque with less belts
- Compact design
- Less maintenance
- Less belt pull
- Synchronous belts do not need to be re-tensioned after it is installed



Baldor•Dodge Drive Components Key Industries

- UNIT HANDLING
- FOREST & PAPER
- FOOD & BEVERAGE
- AIR HANDLING
- MINING
- FLUID HANDLING
- PETRO / CHEM
- AGGREGATE
- CEMENT
- SUGAR

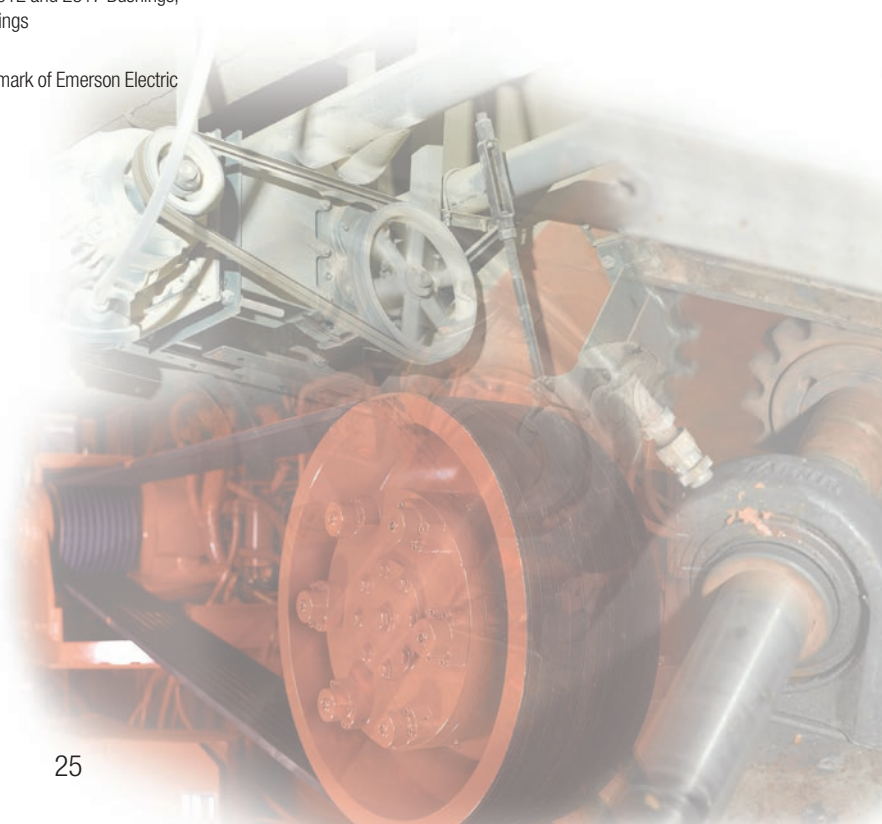

CONVEYOR COMPONENTS



High performance and intelligent design delivering reliability throughout the world for over 100 years.

From underground mines to high in the mountains, Baldor•Dodge® customers expect outstanding performance from their conveyor pulleys.



Baldor•Dodge® delivers by stocking conveyor pulleys with Heavy Duty, Mine Duty and Mine Duty EXTRA constructions. With an extensive range of stock sizes and configurations, Baldor•Dodge® pulleys are available when you need them.

For the ultimate in performance and economy, Baldor•Dodge® offers Engineered conveyor pulleys. Baldor•Dodge® engineers utilize FEA models and state-of-the-art technologies to design conveyor pulleys assemblies of the highest quality.

With unmatched conveyor pulley engineering and manufacturing capabilities, Dodge has the knowledge and expertise to deliver reliability worldwide.

Engineered Pulley Product Features

- Integral hub, profiled, turbine and T-section end disc designs
- Vulcanized lagging
 - Standard SBR, fire and oil resistant Neoprene, or abrasion resistant D-LAG
- High-traction ceramic (available cold bonded or vulcanized)
- HE, XT or Bikon shaft locking devices
- Standard 1045 or high strength 4140 shaft material
- Static and dynamic balancing
- Available stainless steel construction for non-magnetic applications
- Serialized nameplates
- 2 year extended warranty

Manufacturing Capabilities

- High-strength submerged arc welds
- Thermal stress relieving
- CNC machining of shaft and pulley
- Expert assembly of pulley, shaft, bearings, coupling and backstop

Quality Certifications

- ISO 9001:2008
- AWS and ASME certified welding procedures and welders
 - Submerged arc welding
 - Gas metal arc welding
 - Gas tungsten arc welding
- ASNT NDE certified inspection program
 - Ultrasonic, magnetic particle, dye penetrant testing and visual inspection
- Material certifications on all materials

Engineered pulley end disc designs

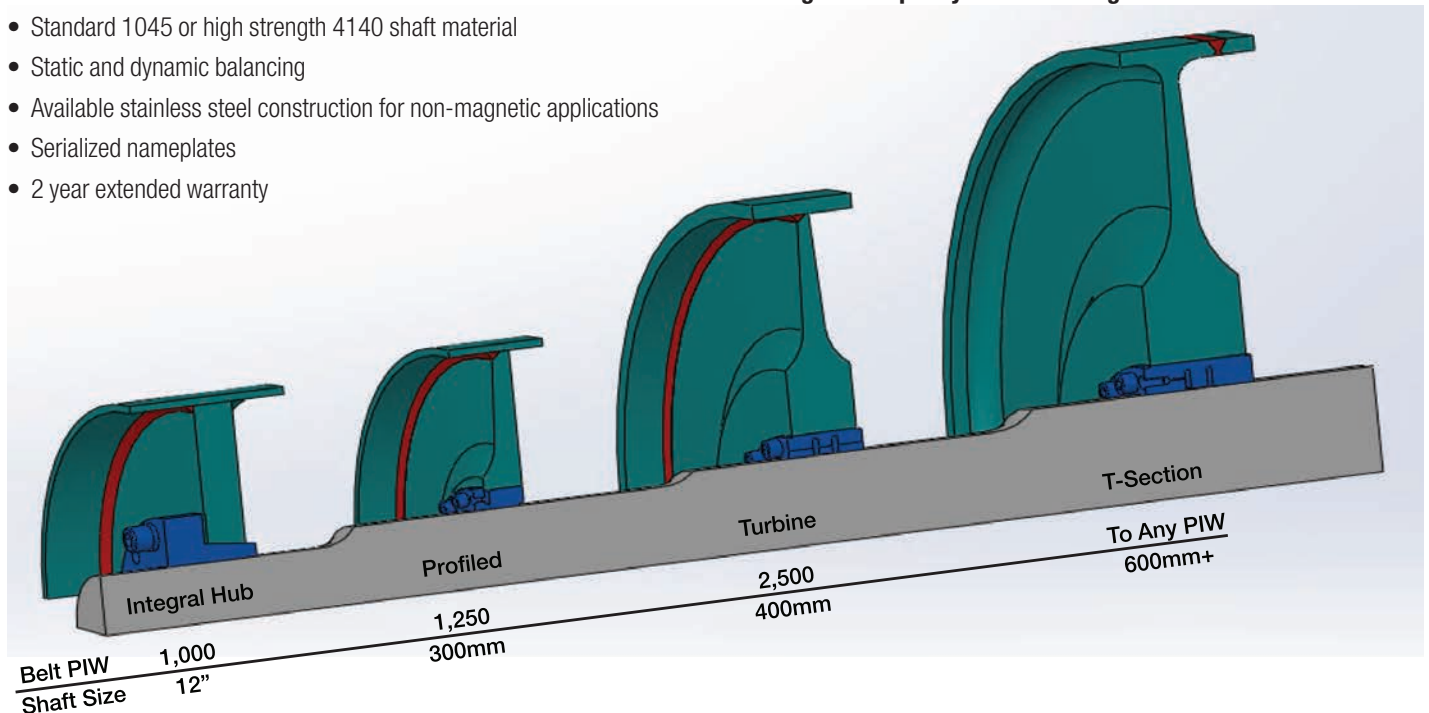



Heavy Duty Drum Pulleys

- Available from stock in over 150+ different sizes and lagging types
- HE, XT, QD or Taper-Lock hub styles available
- Vulcanized lagging up to 1" thick in SBR, Neoprene or D-LAG rubber
- Meets CEMA dimensions
- Exceeds CEMA application standards for use with conveyor belts rated up to 350 PIW (61 kN/m)



Mine Duty Extra Drum Pulleys

- Available from stock in over 100+ different sizes and lagging types
- HE or XT integral hub designs
- Vulcanized lagging up to 1" thick in SBR, Neoprene or D-LAG rubber
- Vulcanized or cold bonded ceramic lagging 1/2", 5/8", 3/4" or 1" thickness
- Meets CEMA dimensions
- Designed for use with conveyor belts rated up to 750 PIW (131kN/m)

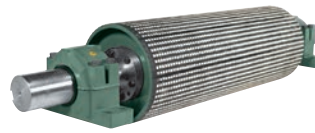

Engineered Drum Pulley

- Custom designs based on conveyor loading for maximum life
- Integral hub, profiled, turbine and T-Section end disc designs
- HE, XT or Bikon hub styles
- Vulcanized lagging up to 1" thick in SBR, Neoprene or D-LAG rubber
- Vulcanized or cold bonded ceramic lagging 1/2", 5/8", 3/4" or 1" thickness
- Imperial or metric dimensions
- Designed for use with conveyor belts exceeding 8,000 PIW (1,400 kN/m)
- 2 year warranty



Spiral Drum Pulleys

- Available in Heavy Duty, Mine Duty Extra, or custom constructions
- HE or XT hub styles available
- 1" x 1" spiral bars welded to rim
- Spirals wound on 3" spacing
- Crowned or straight face
- Designed for mine service tail pulley applications requiring rugged durability with maximum belt cleaning

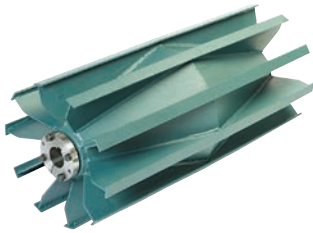

Heavy Duty Wing Pulleys

- Available from stock in over 50+ different sizes
- 6" – 60" diameter
- Face widths exceeding 100"
- Minimum 1/4" x 1-1/2" contact bars
- HE, XT, QD or Taper-Lock hub styles available
- Meets CEMA dimensions
- Slide-on urethane WING-LAG available



Mine Duty Wing Pulleys

- Available from stock in over 20+ different sizes
- 8" – 60" diameter
- Face widths exceeding 100"
- Minimum 5/8" x 1-1/2" contact bars for high durability
- HE, XT, QD or Taper-Lock hub styles available
- Meets CEMA dimensions
- 1/2" SBR rubber vulcanized directly onto wings available



Mine Duty Extra Wing Pulleys

- Over 200+ part numbered sizes available
- 10" thru 60" diameter
- Face widths exceeding 100"
- Minimum 3/4" x 2" contact bars for ultimate durability
- AR400 contact bars available
- HE or XT hub styles available
- Wing folding (up to 42" diameter)
- 1/2" SBR rubber vulcanized directly onto wings available

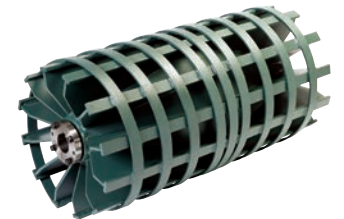

Spiral Wing Pulleys

- Available in Heavy Duty, Mine Duty and Mine Duty Extra constructions
- 6" thru 60" diameter
- Face widths exceeding 100"
- Minimum 1/4" x 1-1/2" spiral contact bars
- HE, XT, QD or Taper-Lock hub styles available
- Smooth running for low impact on belt splices
- Excellent debris removal without interfering with belt scale operation

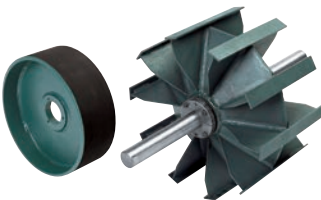

Elevator Pulleys

- Single disc and double disc drum types
- XT, QD or HE hub styles available
- Vulcanized lagging up to 1" thick in SBR or FOS (Fire, oil & static resistant) rubber
- Holz and Holz SOF style 5 lagging
- Up to 72" in diameter; face widths as narrow as 8"
- Exceeds CEMA application standards up to 350 PIW (61 kN/m)



Conveyor Pulley Bushings

- Dodge HE bushings with 14 degree taper angle featuring larger bolts and more bolts versus competitive designs (HE 45 and larger)
- Dodge XT bushings with 9.5 degree taper angle interchange with competitive products
- Dodge QD and QDS bushings offer a 4 degree taper angle and flange mounting
- Dodge Taper-Lock bushings with 8 degree taper angle and slim profile design



Shafting

- Engineering, design and manufacture of custom shafting
- 1045 & 4140 steel standard
- Stainless steel upon request
- Cold rolled, hot rolled and forged
- Ultrasonic and magnetic particle testing available
- Custom keyways, turndowns, drill & tap and tolerance requirements
- Certified prints provided for all custom shafting



Pulley Assemblies

- Complete assembly of conveyor pulley, bushings, shaft, bearings and coupling
- Expert mounting and lubrication of large bore bearings
- All exposed metals covered with anti-rust coating
- Long-term storage preparation available
- Custom pallets for both flatbed and export shipments

CLUTCHES AND BRAKES



Continuing our tradition of developing products that improve the performance and efficiency of your operation, Baldor•Dodge is proud to offer our Torque Tamer mechanical clutches, as well as a

wide range of electrical clutches and brakes.



TORQUE-TAMER®

- Cost effective mechanical overload clutch
- Available with many sizes of sprockets
- Accommodates up to 3" bores and 11,500 in. lbs.



D- SERIES MOTOR BRAKES

- Available with Fan End and Shaft Out (Double C-Face) mounting
- Housing enclosure: Standard Drip Proof and E-Z KLEEN® (NEMA 4X)
- Available for NEMA 56C, 140TC, and 180TC



FRACTIONAL HP CLUTCHES & BRAKES

- Clutches available as couplings or with sheave/sprocket mount
- Brakes available as both 'Power On' and 'Power Off'
- Accommodates up to 1" bores and 250 in. lbs.



CLUTCH/BRAKE MODULES

- Available in clutch only, brake only (less output shaft) and clutch & brake
- Available with double C-face mounting, or shaft-in (Base mounted)
- Available for NEMA 56C, 140TC, 180TC and 210TC motors

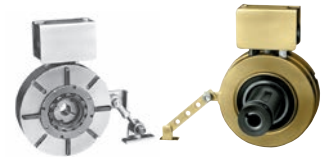

SHAFT & FLANGE MOUNTED CLUTCHES AND BRAKES

- Clutches accept standard sheaves, sprockets and gears
- Can be mounted on standard motor or thru shafts
- Accommodates up to 1-11/16" bores and 175 lb-ft.

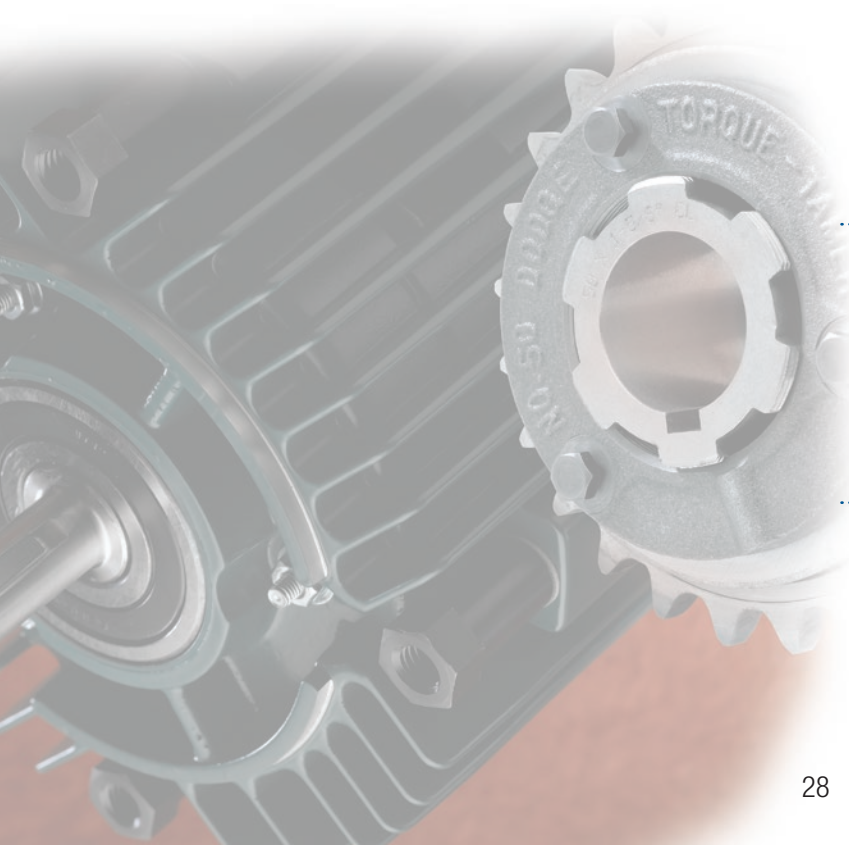

Baldor•Dodge Clutch Brake Key Industries

- PUMPING
- AIR HANDLING
- CONVEYING/BULK MATERIAL HANDLING
- CHEMICAL, OIL AND GAS
- MINING/METALS
- WATER & WASTEWATER
- HVAC
- FOREST/PAPER PRODUCTS
- POWER GENERATION
- AGGREGATE/CEMENT

RENEWAL PARTS



Having an effective and sound maintenance program that insures minimal downtime depends on the ready availability and easy accessibility of quality renewal parts, as well as the knowledge and experience of a value-added support team.

To make part sourcing easy, Baldor•Dodge offers individual and complete spare parts kits with one part number ordering for most of our field serviceable products to insure all needed items are on hand to correctly perform required maintenance or emergency repairs.

Stocking spare parts kits provide protection for equipment breakdowns and minimizes the cost of downtime. The machine can quickly be returned to productivity.

Baldor•Dodge supplies the same parts as specified in new equipment, no substitutes. Contact your local authorized distributor for Baldor•Dodge products or log onto Ptplace.com

RENEWAL
PARTS

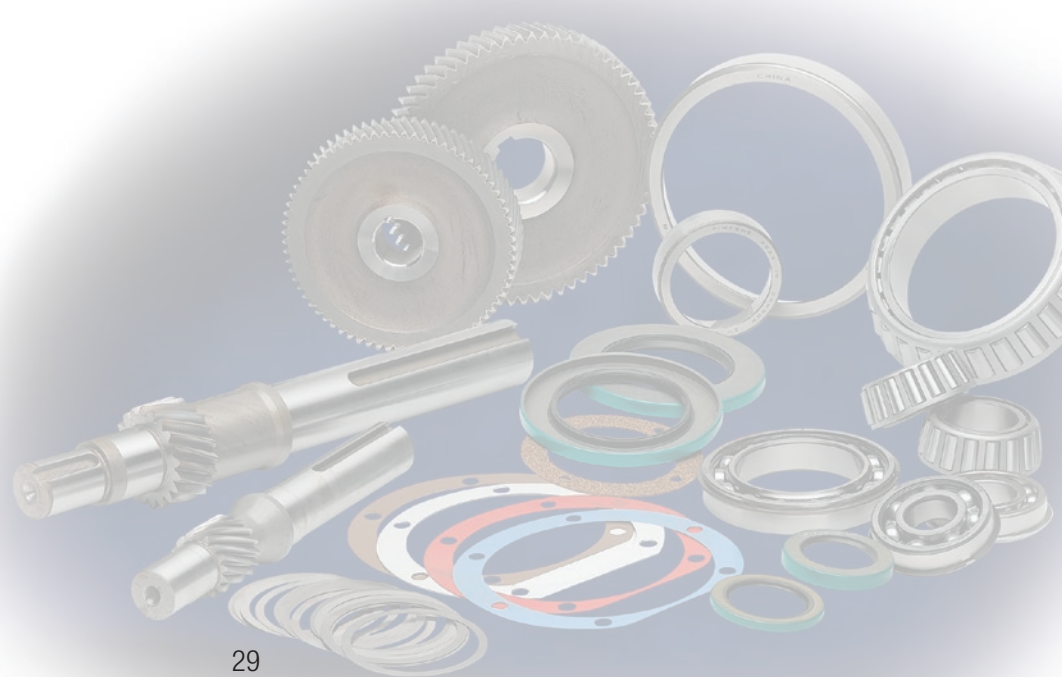

SYSTEM-1™



System-1 offers an integrated single source for all your mechanical and electrical power transmission needs featuring Baldor•Reliance and Baldor•Dodge products. System-1 can optimize your equipment performance and reliability, reduce overall costs, assist in coordinating multi-product projects, and ultimately improve your company's profitability.

Think of how much time and money your company spends in designing, selecting, and sourcing all the Power Transmission components of a drive system. Rather than calling multiple vendors, ordering mismatched components, coordinating multiple shipments from various vendors, and paying multiple bills, just contact System-1 for your next package opportunity. We are the industry's proven single source provider for innovative drive system solutions.

- Unmatched quality
- Optimized product selection
- Single point of contact
- Pre-assembled package

System-1 Key Industries

- AGGREGATE / CEMENT
- MINING / METALS
- FOOD / BEVERAGE / PHARMACEUTICAL
- POWER GENERATION

One System • One Source • One Solution

PRE-ENGINEERED PACKAGES

Torque-Arm II

Shaft Mount Drive

- 5 - 100 HP
- 25 - 100 RPM

Screw Conveyor Drive

- 1 - 40 HP
- 25 - 125 RPM



Magnagear

Right Angle on Swingbase, Base Plate, or Tunnel Housing

- 50 - 400 Solid and Hollow Output

Parallel on Heavy Duty Base Plate

- 50 - 600 HP Solid Output

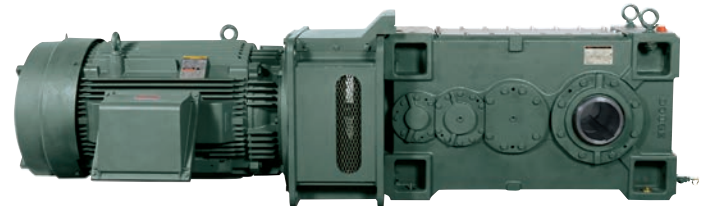

Creep Drive

- 75 - 200 HP Single Drive
- 150 - 400 HP Dual Drive



E-COMMERCE

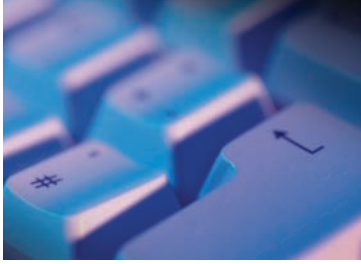

E-Commerce is the electronic exchange of goods and services, typically via the Internet.

For years, Baldor•Dodge has been a technological leader in the automation industry. We continue that leadership today, utilizing the latest e-Commerce technologies to conduct business with our valued customers. This allows them to become more efficient and lower their overall operating costs.

We offer a variety of e-Commerce solutions and can help you determine which method is right for your company.

E-Commerce is the electronic exchange of information to allow customers to be more efficient and lower their overall time and operating costs.

Available E-Commerce Sites and Services:

- EDI – Electronic Data Interchange
Direct System-to-System interfacing
- PTplace.com (www.ptplace.com)
Online ordering and shipment tracking
- PT Wizard Online (www.ptwizard.com)
Online product selection tools
- Quantis Configurator (available thru PT Place.com)
Online selection and ordering of Dodge Quantis gear reducers



INDUSTRY SOLUTIONS TEAM

Offering Customers Value Solutions

Baldor Electric Company is the only motor, drive and mechanical power transmission manufacturer that has a dedicated Industry Solutions Team that serves our key industries. This team is comprised of industry experts that have worked directly in their field and know the customers' critical processes. They are available to help apply our products in demanding applications and to help solve customer solution needs. Our mission is to provide industry and technical expertise that improve processes and lower total operating costs.

Industry Solution Teams provide the following services:

- Industry Application Solutions (IAS) – the teams will evaluate the problem applications and offer solutions that provide longer life and reduce operating costs.
- System/Asset Optimization - the team can provide system optimization studies for motor and drive applications.
- Reduced Operating Costs - from premium efficient motors to high efficient gearing, the team offers solutions that lower the total operating costs.
- Specification Support - the team can assist customers in writing their technical specifications that outline the minimum requirements for motors, drives, bearings and gearing.
- Product and Industry Application Solution Training – the team provides on site training for new products and maintenance.
- Teardown/Root Cause Failure Analysis - for repeated failures, the team offers a complete forensic teardown of failed products to determine the root cause of failure.



IBE TEAM

Installed Based Evaluation Team

Identifying Opportunities to Standardize Products and Improve Energy Efficiency

Using state of the art data collection equipment and software, Baldor's IBE Team works with plant maintenance personnel to take an accurate account of motors and mechanical products both in operation, and from spare inventory locations. The raw data is then analyzed to produce a comprehensive report for the customer, which not only includes recommendations for immediate actions, but also long term strategies that will result in significant energy savings to favorably impact the customer's bottom line.

IBE Report Includes:

- Detailed list of motors, gearboxes and bearings in service and spares
- Standardization Analysis
- Potential Energy Savings
- Payback timing
- Repair/Replace comparisons
- Spares Analysis
- Local rebate and incentive program details

In addition, the information collected can help to facilitate a partnership between the end user, distribution, and district offices, so that the end user can rely on outside inventory support and reduce the number of spares on hand. An IBE is also a proactive way for companies to display that they are environmentally focused on reducing their carbon footprint through energy conservation.

Benefits of an IBE:

- Energy Savings
- Better understanding of equipment currently in service
- Framework for motor management program
- Improved uptime through better motor performance
- Simplifies purchasing and Inventory management
- Consolidation of redundant vendors and part numbers

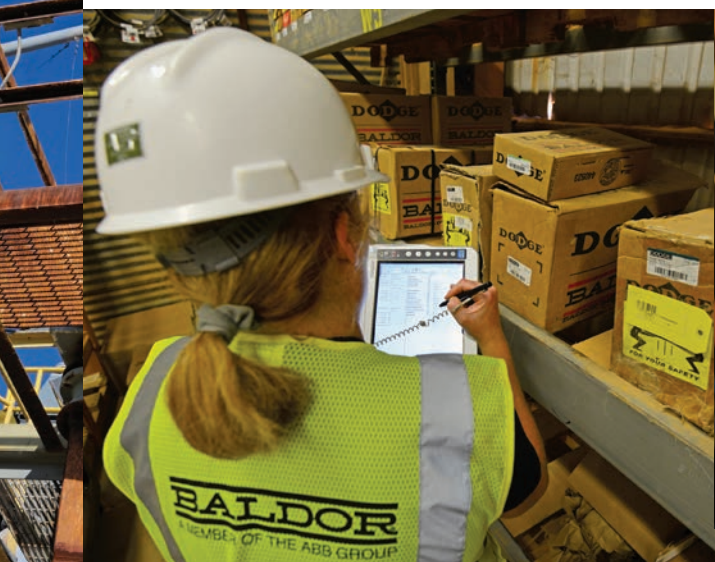

The First Name in Power Transmission



BALDOR • DODGE

Baldor•Dodge® power transmission products offer reliable service and low maintenance to help reduce your total cost of ownership. Our innovative bearings, gearing and power transmission products have solved the toughest applications for over 130 years.

Our technical sales team can help you with the most challenging applications, and our worldwide distributor network ensures immediate delivery.

When it comes to PT solutions, Baldor•Dodge is the first name in power transmission.

baldor.com 479-646-4711

- Unmatched Quality
- Superior Reliability
- Improved Uptime
- Quick Delivery
- American Made Since 1880

BALDOR
A MEMBER OF THE ABB GROUP



Baldor Electric Company

P.O. Box 2400, Fort Smith, AR 72902-2400 U.S.A., Ph: (1) 479.646.4711, Fax (1) 479.648.5792, International Fax (1) 479.648.5895

Baldor - Dodge

6040 Ponders Court, Greenville, SC 29615-4617 U.S.A., Ph: (1) 864.297.4800, Fax: (1) 864.281.2433

www.baldor.com