



High Performance Cutting Tools



CARBIDE BURRS



High Performance Cutting Tools



CARBIDE BURRS



CARBIDE BURR

SERIES	SHAPE DESCRIPTION	TOTEM REFERENCE	PAGE
SA/ZYA	Cylindrical without end cut	C	4.003
SB/ZYAS	Cylindrical with end cut	CE	4.006
SC/WRC	Cylindrical with radius end	B	4.009
SD/KUD	Ball Shape	S	4.012
SE/TRE	Oval shape burr	O	4.015
SF/RBF	Tree shape with radius end	TB	4.017
SG/SPG	Tree shape with point end	T	4.020
SH	Flame shape	F	4.022
SL/KEL	Cone with radius burr	K	4.023
SM/SKM	Cone shaped burr	A	4.025
SN	Inverted cone shape burrs	N	4.027
RIM	Rim shape burrs	R	4.028
-	Burr Sets	-	4.029

SA

Cylindrical without end cut

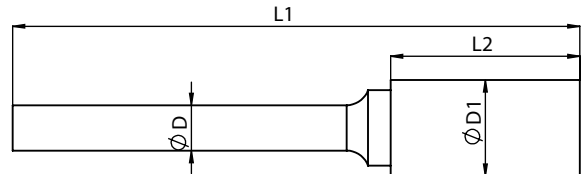

3mm Shank								Unit : mm
Head Diameter	Head length	Overall Length	Tool No	Standard cut	Supreme cut	Deluxe cut	CTI Number	
ØD1	L2	L1		EDP No.	EDP No.	EDP No.		
1.5	6	50	MC4L	FAC0200588	FAC0200589	FAC0200590	SA-41ML2	
1.5	6	75	MC4L1	FAC0200591	FAC0200592	FAC0200593	SA-41ML3	
1.5	6	38	MC4	FAC0200585	FAC0200586	FAC0200587	SA-41M	
2.5	11	38	MC5	FAC0200594	FAC0200595	FAC0200596	SA-42M	
2.5	11	50	MC5L	FAC0200597	FAC0200598	FAC0200599	SA-42ML2	
2.5	11	75	MC5L1	FAC0200600	FAC0200601	FAC0200602	SA-42ML3	
3	16	38	MC1	FAC0200563	FAC0200565	FAC0200566	SA-43M	
3	16	75	MC1L1	FAC0200570	FAC0200571	FAC0200572	SA-43ML3	
3	16	50	MC1L	FAC0200567	FAC0200568	FAC0200569	SA-43ML2	
6.3	6.3	38	MC2	FAC0200573	FAC0200574	FAC0200575		
6.3	12.7	38	MC3	FAC0200582	FAC0200583	FAC0200584	SA-51M	
6.3	6.3	50	MC2L	FAC0200576	FAC0200577	FAC0200578		
6.3	6.3	75	MC2L1	FAC0200579	FAC0200580	FAC0200581		

SA **Cylindrical without end cut**

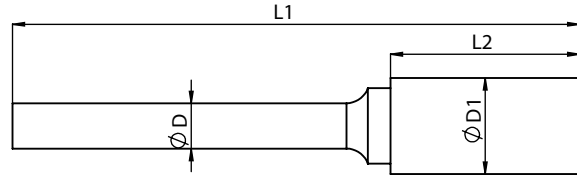

CARBIDE BURRS



6mm Shank							Unit : mm
Head Diameter	Head length	Overall Length	Tool No	Standard cut	Supreme cut	Deluxe cut	CTI Number
ØD1	L2	L1		EDP No.	EDP No.	EDP No.	
3	12.7	50	C0	FAC0200208	FAC0200209	FAC0200210	SA-11M
3.8	14	50	C1	FAC0200211	FAC0200212	FAC0200213	SA-13M
5	16	50	C11	FAC0200306	FAC0200307	FAC0200308	SA-14M
6	20	50	C2	FAC0200220	FAC0200221	FAC0200222	
6	20	170	C2L2	FAC0200232	FAC0200233	FAC0200234	SA-1ML6
6	25	50	C2H	FAC0200223	FAC0200224	FAC0200225	
6.3	16	66	C12	FAC0200309	FAC0200310	FAC0200311	SA-1
8	19	69	C3	FAC0200236	FAC0200237	FAC0200238	SA-2M
9.5	19	69	C4	FAC0200246	FAC0200247	FAC0200248	SA-3M
9.5	19	169	C4L2	FAC0200252	FAC0200253	FAC0200254	SA-3ML6
10	25	75	C13	FAC0200312	FAC0200313	FAC0200314	SA-3MZ
11	25	75	C14	FAC0200315	FAC0200316	FAC0200317	SA-4M
12.7	19	69	C5	FAC0200259	FAC0200263	FAC0200265	
12.7	14	64	C7	FAC0200281	FAC0200282	FAC0200283	
12.7	25	75	C8	FAC0200285	FAC0200286	FAC0200287	SA-5M
12.7	25	175	C8L2	FAC0200288	FAC0200289	FAC0200290	SA-5ML6
16	25	75	C6	FAC0200273	FAC0200275	FAC0200277	SA-6M
19	25	70	C9	FAC0200294	FAC0200296	FAC0200298	SA-7M
25	25	75	C10	FAC0200300	FAC0200302	FAC0200304	SA-9M

SA

Cylindrical without end cut

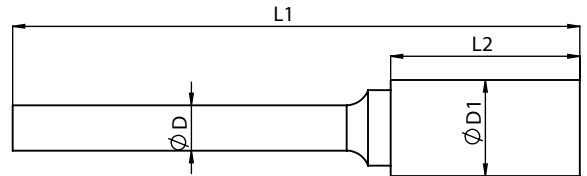

Unit : mm

8mm Shank			Tool No	Standard cut	Supreme cut	Deluxe cut	CTI Number
Head Diameter	Head length	Overall Length		EDP No.	EDP No.	EDP No.	
ØD1	L2	L1					
9.5	19	69			FAC0200248		
12.7	19	69	C5Z	FAC0200261	FAC0200264	FAC0200266	
16	25	75	C6Z	FAC0200274	FAC0200276	FAC0200278	SA-6M8
19	25	70	C9Z	FAC0200295	FAC0200297	FAC0200299	SA-7M8
25	25	75	C10Z	FAC0200301	FAC0200303	FAC0200305	



6mm Shank			Tool No	Aluma Cut	Coarse Cut	CTI Number
Head Diameter	Head length	Overall Length		EDP No.	EDP No.	
ØD1	L2	L1				
8	19	69	C3	FAC0200245	FAC0201408	SA-2M
9.5	19	69	C4	FAC0200258	FAC0201409	SA-3M
12.7	19	69	C5	-	FAC0201410	
12.7	14	64	C7	FAC0200284	-	
12.7	25	75	C8	FAC0200292	FAC0201411	SA-5M
12.7	25	175	C8L2	FAC0200293	-	SA-5ML6
16	25	75	C6	FAC0200279	-	SA-6M

8mm Shank			Tool No	Aluma Cut	CTI Number
Head Diameter	Head length	Overall Length		EDP No.	
ØD1	L2	L1			
16	25	75	C6Z	FAC0200280	SA-6M8

SB

Cylindrical with end cut

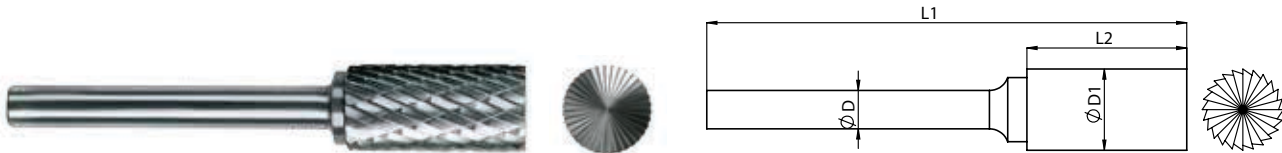

CARBIDE BURRS



3mm Shank							Unit : mm
Head Diameter	Head length	Overall Length	Tool No	Standard cut	Supreme cut	Deluxe cut	CTI Number
ØD1	L2	L1		EDP No.	EDP No.	EDP No.	
2.5	11	38	MCE5	FAC0200624	FAC0200625	FAC0200626	SB-42M
2.5	11	50	MCE5L	FAC0200627	FAC0200628	-	SB-42ML2
2.5	11	75	MCE5L1	FAC0200630	FAC0200631	FAC0200632	SB-42ML3
3	16	38	MCE1	FAC0200603	FAC0200604	FAC0200605	SB-43M
3	16	50	MCE1L	FAC0200606	FAC0200607	FAC0200608	SB-43ML2
3	16	75	MCE1L1	FAC0200609	FAC0200610	FAC0200611	SB-43ML3
6.3	6.3	38	MCE2	FAC0200612	FAC0200613	FAC0200614	
6.3	6.3	50	MCE2L	FAC0200615	FAC0200616	FAC0200617	
6.3	6.3	75	MCE2L1	FAC0200618	FAC0200619	FAC0200620	
6.3	12.7	38	MCE3	FAC0200621	FAC0200622	FAC0200623	SB-51M
6.3	16	66	CE12	FAC0200391	FAC0200392	FAC0200393	SB-1

SB

Cylindrical with end cut

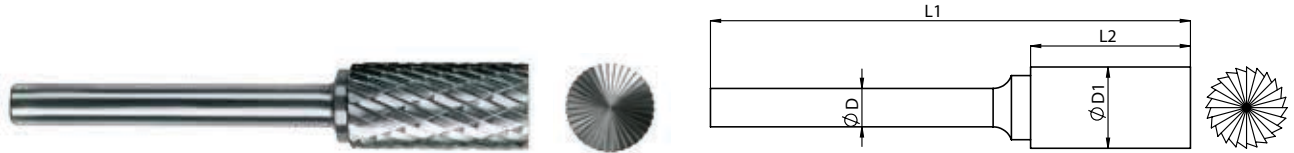

6mm Shank		Unit : mm					
Head Diameter	Head length	Overall Length	Tool No	Standard cut	Supreme cut	Deluxe cut	CTI Number
ØD1	L2	L1		EDP No.	EDP No.	EDP No.	
3	12.7	50	CE0	FAC0200318	FAC0200319	FAC0200320	SB-11M
3.8	14	50	CE1	FAC0200321	FAC0200322	FAC0200323	SB-13M
5	16	50	CE11	FAC0200388	FAC0200389	FAC0200390	SB-14M
5.8	20	50	CE2	FAC0200326	FAC0200327	FAC0200328	
5.8	20	170	CE2L2	FAC0200335	FAC0200336	FAC0200337	SB-1ML6
5.8	25	50	CE2H	FAC0200329	FAC0200330	FAC0200331	
8	19	69	CE3	FAC0200339	FAC0200340	FAC0200341	SB-2M
9.5	19	69	CE4	FAC0200344	FAC0200345	FAC0200346	SB-3M
9.5	19	169	CE4L2	FAC0200349	FAC0200350	-	
10	25	75	CE13	FAC0200394	FAC0200395	FAC0200396	
11	25	75	CE14	FAC0200397	FAC0200398	FAC0200399	
12.7	19	69	CE5	FAC0200352	FAC0200353	FAC0200355	
12.7	14	64	CE7	FAC0200364	FAC0200365	FAC0200366	
12.7	25	75	CE8	FAC0200368	FAC0200369	FAC0200371	SB-5M
12.7	25	175	CE8L2	FAC0200372	FAC0200373	FAC0200374	SB-5ML6
16	25	75	CE6	FAC0200356	FAC0200358	FAC0200360	SB-6M
19	25	75	CE9	FAC0200276	FAC0200378	FAC0200380	SB-7M
25	25	75	CE10	FAC0200382	FAC0200384	FAC0200386	

SB

Cylindrical with end cut

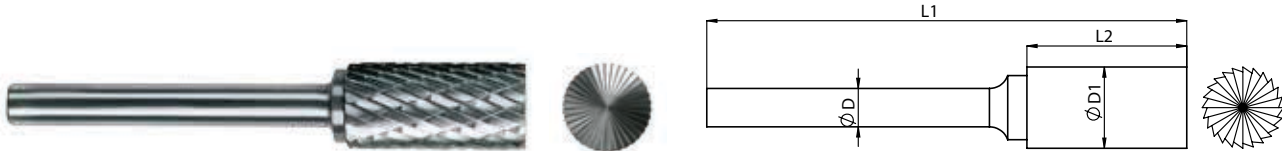

CARBIDE BURRS



Unit : mm

8mm Shank			Tool No	Standard cut	Supreme cut	Deluxe cut	CTI Number
Head Diameter	Head length	Overall Length		EDP No.	EDP No.	EDP No.	
ØD1	L2	L1					
9.5	19	69	CE4Z	-	FAC0201278	-	
12.7	19	69	CE5Z	-	FAC0200354	FAC0200355	
12.7	25	75	CE8Z	-	FAC0200370	FAC0201293	
19	25	75	CE9Z	FAC0200377	FAC0200379	FAC0200381	SB-7M8
16	25	75	CE6Z	FAC0200357	FAC0200359	FAC0200361	SB-6M8
25	25	75	CE10Z	FAC0200383	FAC0200385	FAC0200387	



3mm Shank			Tool No	Aluma Cut	CTI Number
Head Diameter	Head length	Overall Length		EDP No.	
ØD1	L2	L1			
6.3	16	60	MCE12	FAC0201339	SB-1

6mm Shank			Tool No	EDP No.	CTI Number
Head Diameter	Head length	Overall Length			
ØD1	L2	L1			
3.8	14	50	CE1	FAC0201338	SB-13M
5.8	20	50	CE2	FAC0201270	
8	19	69	CE3	FAC0201340	SB-2M
10	25	69	CE13	FAC0201341	
12.7	19	69	CE5	FAC0201232	
12.7	14	64	CE7	FAC0200367	
12.7	25	75	CE8	FAC0201342	SB-5M
16	25	75	CE6	FAC0200362	SB-6M

SC

Cylindrical with radius end

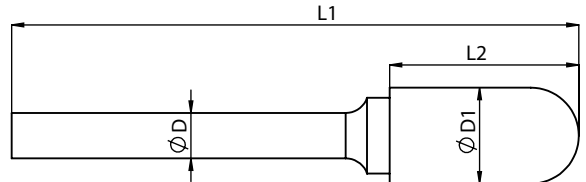

3mm Shank			Unit : mm				
Head Diameter	Head length	Overall Length	Tool No	Standard cut	Supreme cut	Deluxe cut	CTI Number
ØD1	L2	L1		EDP No.	EDP No.	EDP No.	
2.5	11	38	MB0	FAC0200542	FAC0200543	FAC0200544	SC-41M
3	16	38	MB1	FAC0200545	FAC0200547	FAC0200548	SC-42M
3	16	50	MB1L	FAC0200549	FAC0200550	FAC0200551	SC-42ML2
3	16	75	MB1L1	FAC0200552	FAC0200553	FAC0200554	SC-43ML3
6.3	12.7	38	MB2	FAC0200556	FAC0200557	FAC0200558	SC-51
6.3	12.7	50	MB2L	FAC0200559	FAC0200560	FAC0200561	SC-51L2

6mm Shank			Unit : mm				
Head Diameter	Head length	Overall Length	Tool No	Standard cut	Supreme cut	Deluxe cut	CTI Number
ØD1	L2	L1		EDP No.	EDP No.	EDP No.	
3	16	60	B0	FAC0200074	FAC0200075	FAC0200076	SC-12M
4	19	55	B7	FAC0200175	FAC0200176	FAC0200177	SC-13M
5	19	70	B8	FAC0200178	FAC0200179	FAC0200180	SC-14M
6	20	50	B1	FAC0200077	FAC0200078	FAC0200079	SC-1ML6
6	20	160	B1L2	FAC0200087	FAC0200088	FAC0200089	
6	25	50	B1H	FAC0200080	FAC0200081	FAC0200082	SC-1ML
6.3	16	66	B11	FAC0200197	FAC0200198	FAC0200199	SC-1M
8	19	69	B2	FAC0200097	FAC0200098	FAC0200099	SC-2M
9.5	19	69	B3	FAC0200113	FAC0200115	FAC0200117	SC-3M
9.5	19	169	B3L2	FAC0200121	FAC0200122	FAC0200123	SC-3ML6

SC

Cylindrical with radius end

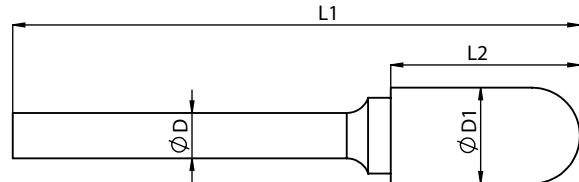

CARBIDE BURRS



6mm Shank							Unit : mm
Head Diameter	Head length	Overall Length	Tool No	Standard cut	Supreme cut	Deluxe cut	CTI Number
$\varnothing D1$	L2	L1		EDP No.	EDP No.	EDP No.	
10	25	75	B12	FAC0200200	FAC0200201	FAC0200202	SC-3MZ
11	25	75	B13	FAC0200204	FAC0200205	FAC0200206	SC-4M
12.7	19	69	B4	FAC0200132	FAC0200134	FAC0200136	
12.7	25	75	B6	FAC0200157	FAC0200159	FAC0200161	SC-5M
12.7	25	175	B6L2	FAC0200163	FAC0200164	FAC0200165	SC-5ML6
16	25	75	B5	FAC0200145	FAC0200147	FAC0200149	SC-6M
19	25	75	B9	FAC0200181	FAC0200183	FAC0200185	SC-7M
25	25	75	B10	FAC0200189	FAC0200191	FAC0200193	SC-9M

8mm Shank							
Head Diameter	Head length	Overall Length	Tool No	Standard cut	Supreme cut	Deluxe cut	CTI Number
$\varnothing D1$	L2	L1		EDP No.	EDP No.	EDP No.	
8	19	69	B2Z	FAC0200098	FAC0200100	-	
9.5	19	69	B3Z	FAC0200114	FAC0200116	-	
12.7	19	69	B4Z	FAC0200133	FAC0200135	FAC0200137	
16	25	75	B5Z	FAC0200146	FAC0200148	FAC0200150	SC-6M8
12.7	25	75	B6Z	FAC0200158	FAC0200160	-	
19	25	75	B9Z	FAC0200182	FAC0200184	FAC0200186	SC-7M8
25	25	75	B10Z	FAC0200190	FAC0200192	FAC0200194	SC-9M8

SC

Cylindrical with radius end

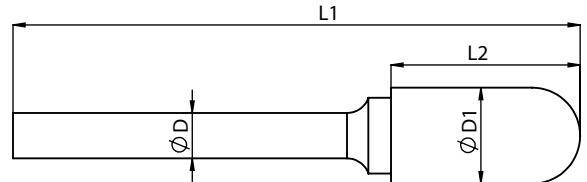

Unit : mm

6mm Shank			Tool No	Aluma Cut	Coarse Cut	CTI Number
Head Diameter	Head length	Overall Length		EDP No.	EDP No.	
ØD1	L2	L1				
8	19	69	B2	FAC0200112	FAC0201404	SC-2M
9.5	19	69	B3	FAC0200131	FAC0201405	SC-3M
10	25	75	B12	FAC0200203	-	SC-3MZ
11	25	75	B13	FAC0200207	-	SC-4M
12.7	19	69	B4	FAC0200144	FAC0201406	
12.7	25	75	B6	FAC0200173	FAC0201407	SC-5M
16	25	75	B5	FAC0200144	-	SC-6M
19	25	75	B9	FAC0200187	-	SC-7M
25	25	75	B10	FAC0200195	-	SC-9M

8mm Shank			Tool No	Aluma Cut	CTI Number
Head Diameter	Head length	Overall Length		EDP No.	
ØD1	L2	L1			
12.7	19	69	B6Z	FAC0200174	
16	25	75	B5Z	FAC0200156	SC-6M8
19	25	75	B9Z	FAC0200188	SC-7M8
25	25	75	B10Z	FAC0200196	SC-9M8

CARBIDE BURRS

SD

Ball Shape

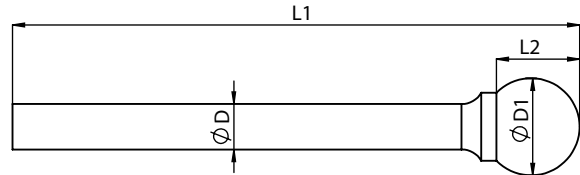

CARBIDE BURRS



Unit : mm

3mm Shank			Tool No	Standard cut	Supreme cut	Deluxe cut	CTI Number
Head Diameter	Head length	Overall Length		EDP No.	EDP No.	EDP No.	
ØD1	L2	L1					
2.5	2.3	38	MS2	FAC0200691	FAC0200692	FAC0200693	SD-41M
3	2.5	38	MS0	FAC0200678	FAC0200679	FAC0200680	SD-42M
3	2.5	50	MS0L	FAC0200681	FAC0200682	FAC0200683	SD-42ML2
3	2.5	75	MS0L1	FAC0200684	FAC0200685	FAC0200686	SD-42ML3
3	3	75	MS3	FAC0201249	FAC0201250	FAC0201251	
4	3.4	38	MS1	FAC0200687	FAC0200689	FAC0200690	SD-52M

6mm Shank			Tool No	Standard cut	Supreme cut	Deluxe cut	CTI Number
Head Diameter	Head length	Overall Length		EDP No.	EDP No.	EDP No.	
6.3	6.3	50	S1	FAC0200805	FAC0200806	FAC0200807	SD-1
8	6.4	50	S2	FAC0200814	FAC0200815	FAC0200817	SD-2M
9.5	8	58	S3	FAC0200824	FAC0200826	FAC0200828	SD-3M
25	21	71	S7	FAC0200875	FAC0200877	FAC0200879	SD-9M
11	9.5	60	S9	FAC0200883	FAC0200884	FAC0200885	SD-4M
12.7	11	62	S4	FAC0200838	FAC0200840	FAC0200842	SD-5M
16	14	65	S5	FAC0200854	FAC0200856	FAC0200858	SD-6M
19	16	66	S6	FAC0200867	FAC0200869	FAC0200871	SD-7M
6.3	5	155	S1L2	FAC0200811	FAC0200812	FAC0200813	SD-1L6
9.5	8	158	S3L2	FAC0200831	FAC0200832	FAC0200833	SD-3ML6
12.7	11	161	S4L2	FAC0200846	FAC0200847	FAC0200848	SD-5ML6
16	14	164	S5L2	FAC0200862	-	-	

SD

Ball Shape

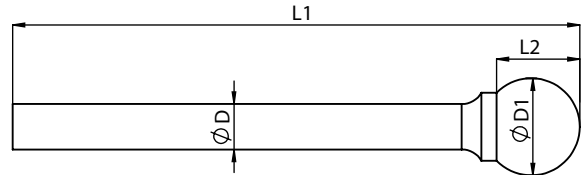

Unit : mm

8mm Shank			Tool No	Standard cut	Supreme cut	Deluxe cut	CTI Number
Head Diameter	Head length	Overall Length		EDP No.	EDP No.	EDP No.	
ØD1	L2	L1					
8	6.4	50	S2Z	-	FAC0200816	FAC0200880	
9.5	8	60	S3Z	FAC0200825	FAC0200827	-	
25	21	71	S7Z	FAC0200876	FAC0200878	-	SD-9M8
12.7	11	62	S4Z	FAC0200839	FAC0200841	FAC0200843	
16	14	65	S5Z	FAC0200855	FAC0200857	FAC0200859	
19	16	66	S6Z	FAC0200868	FAC0200870	FAC0200872	SD-7M8

SD

Ball Shape

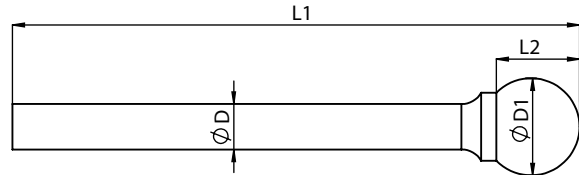

CARBIDE BURRS

6mm Shank			Unit : mm			
Head Diameter	Head length	Overall Length	Tool No	Aluma Cut	Coarse Cut	CTI Number
ØD1	L2	L1		EDP No.	EDP No.	
6.3	6.3	50	S1	FAC0201351	-	SD-1
8	6.4	50	S2	-	FAC0201412	SD-2M
9.5	8	58	S3	FAC0200836	FAC0201413	SD-3M
9.5	8	158	S3L2	FAC0200837	-	SD-3ML6
11	21	71	S7	FAC0200881	-	SD-9M
11	9.5	60	S9	FAC0200886	-	SD-4M
12.7	11	62	S4	FAC0200852	FAC0201414	SD-5M
12.7	11	161	S4L2	FAC0200853	-	SD-5ML6
16	14	65	S5	FAC0200864	FAC0201415	SD-6M
19	16	70	S6	FAC0200873	-	SD-7M

8mm Shank					
Head Diameter	Head length	Overall Length	Tool No	Aluma Cut	CTI Number
ØD1	L2	L1		EDP No.	
25	21	69	S7Z	FAC0200882	SD-9M8
16	14	65	S5Z	FAC0200865	
19	16	62	S6Z	FAC0200874	SD-7M8

SE

Oval shape burr

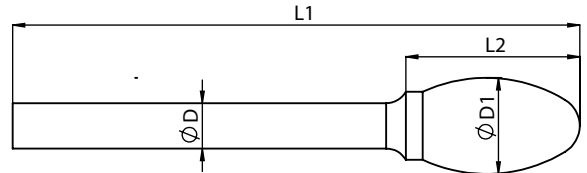

Unit : mm

3mm Shank			Tool No	Standard cut	Supreme cut	Deluxe cut	CTI Number
Head Diameter	Head length	Overall Length		EDP No.	EDP No.	EDP No.	
ØD1	L2	L1					
3	8	38	M01	FAC0200659	FAC0200660	FAC0200661	SE-41M
3	8	50	M01L	FAC0200662	FAC0200663	FAC0200664	SE-41ML2
3	8	75	M01L1	FAC0200665	FAC0200666	FAC0200667	SE-41ML3
6.3	9.5	38	M02	FAC0200668	FAC0200669	FAC0200670	SE-51M
6.3	9.5	50	M02L	FAC0200671	FAC0200672	FAC0200673	SE-51ML2
6.3	9.5	75	M02L1	FAC0200674	FAC0200675	FAC0200676	SE-51ML3

6mm Shank			Tool No	Standard cut	Supreme cut	Deluxe cut	CTI Number
Head Diameter	Head length	Overall Length		EDP No.	EDP No.	EDP No.	
6.3	10	60	O4	FAC0200755	FAC0200756	FAC0200757	SE-1
6.3	10	160	O4L2	FAC0200758	FAC0200759	FAC0200760	SE-1L6
8	12	62	O1	FAC0200726	FAC0200727	FAC0200728	SE-2M
8	12	158	O1L2	FAC0200731	-	FAC0200767	
9.5	16	65	O5	FAC0200762	FAC0200763	FAC0200764	SE-3M
9.5	16	166	O5L2	FAC0200765	FAC0200766	FAC0200775	SE-3ML6
12.7	19	69	O2	FAC0200735	FAC0200737	FAC0200739	
12.7	22	71	O6	FAC0200770	FAC0200771	FAC0200772	SE-5M
12.7	22	172	O6L2	FAC0200773	FAC0200774	-	SE-5ML6
16	25	75	O3	FAC0200747	FAC0200749	FAC0200751	SE-6M
19	25	75	O7	FAC0200778	FAC0200780	FAC0200782	SE-7M

SE

Oval shape burr

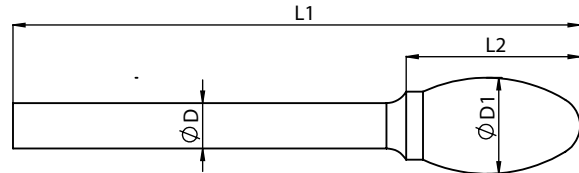

CARBIDE BURRS



8mm Shank			Tool No	Standard cut	Supreme cut	Deluxe cut	CTI Number
Head Diameter	Head length	Overall Length		EDP No.	EDP No.	EDP No.	
ØD1	L2	L1					
9.5	16	65	05Z		FAC0201269		SE-3M8
12.7	19	69	02Z	FAC0200736	FAC0200738	FAC0200740	
16	25	75	03Z	FAC0200748	FAC0200750	FAC0200752	SE-6M8
19	25	75	07Z	FAC0200779	FAC0200781	FAC0200783	SE-7M8



6mm Shank			Tool No	Aluma Cut	Coarse Cut	CTI Number
Head Diameter	Head length	Overall Length		EDP No.	EDP No.	
ØD1	L2	L1				
8	12	62	01	FAC0200734	FAC0201418	SE-2M
9.5	16	65	05	FAC0200768	-	SE-3M
9.5	16	166	05L2	FAC0200769	-	SE-3ML6
12.7	19	69	02	FAC0200746	FAC0201419	
12.7	22	71	06	FAC0200776	-	SE-5M
12.7	22	172	06L2	FAC0200777	-	SE-5ML6
16	25	75	03	FAC0200754	-	SE-6M
19	25	69	07	FAC0200784	-	SE-7M

SF

Tree shape with radius end

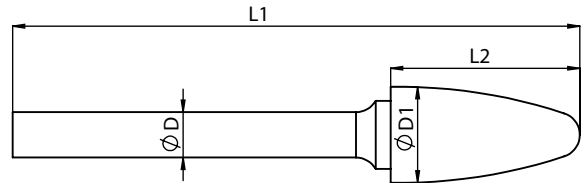

Unit : mm

3mm Shank			Tool No	Standard cut	Supreme cut	Deluxe cut	CTI Number
Head Diameter	Head length	Overall Length		EDP No.	EDP No.	EDP No.	
ØD1	L2	L1					
3	6	38	MTB1	FAC0200714	FAC0200715	FAC0200716	SF-41M
3	12.7	38	MTB2	FAC0200717	FAC0200718	FAC0200719	
3	12.7	50	MTB2L	FAC0200720	FAC0200721	FAC0200722	
3	12.7	75	MTB2L1	FAC0200723	FAC0200724	FAC0200725	

6mm Shank			Tool No	Standard cut	Supreme cut	Deluxe cut	CTI Number
Head Diameter	Head length	Overall Length		EDP No.	EDP No.	EDP No.	
6	19	69	TB1	FAC0200962	FAC0200963	FAC0200964	SF-1M
6	169	19	TB1L2	FAC0200966	FAC0200967	FAC0200968	SF-1ML6
6.3	16	65	TB6	FAC0201014	FAC0201015	FAC0201016	SF-1
8	19	69	TB5	FAC0201011	FAC0201012	FAC0201013	SF-2M
9.5	19	69	TB2	FAC0200971	FAC0200973	FAC0200975	SF-3M
9.5	169	19	TB2L2	FAC0200980	FAC0200981	FAC0200982	SF-3ML6
11	25	75	TB7	FAC0201017	FAC0201018	FAC0201019	SF-4M
12.7	25	75	TB3	FAC0200988	FAC0200990	FAC0200992	SF-5M
12.7	175	25	TB3L2	FAC0200997	FAC0200998	FAC0200999	SF-5ML6
16	32	82	TB4	FAC0201004	FAC0201006	FAC0201008	
16	25	75	TB8	FAC0201022	FAC0201024	FAC0201026	SF-6M
19	25	75	TB9	FAC0201030	FAC0201032	FAC0201034	SF-7M

SF

Tree shape with radius end

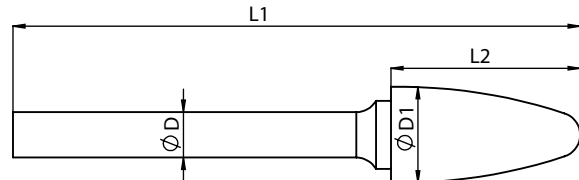

CARBIDE BURRS

8mm Shank						Unit : mm	
Head Diameter	Head length	Overall Length	Tool No	Standard cut	Supreme cut	Deluxe cut	CTI Number
ØD1	L2	L1		EDP No.	EDP No.	EDP No.	
9.5	19	69	TB2Z	FAC0200972	FAC0200974	FAC0200976	
12.7	25	75	TB3Z	FAC0200989	FAC0200991	FAC0200993	
16	32	82	TB4Z	FAC0201005	FAC0201007	FAC0201009	
16	25	75	TB8Z	FAC0201023	FAC0201025	FAC0201027	SF-6M88
19	25	75	TB9Z	FAC0201031	FAC0201033	FAC0201035	SF-7M8

6mm Shank						
Head Diameter	Head length	Overall Length	Tool No	Aluma Cut	Coarse Cut	CTI Number
ØD1	L2	L1		EDP No.	EDP No.	
6	19	169	TB1L2	FAC0200970	-	SF-1ML6
8	19	69	TB5	FAC0201345	-	SF-2M
9.5	19	69	TB2	FAC0200986	FAC0201420	SF-3M
9.5	19	169	TB2L2	FAC0200987	-	SF-3ML6
11	25	75	TB7	FAC0201021	FAC0201422	SF-4M
12.7	25	75	TB3	FAC0201002	FAC0201421	SF-5M
12.7	25	175	TB3L2	FAC0201003	-	SF-5ML6
16	25	75	TB8	FAC0201028	-	SF-6M
19	25	75	TB9	FAC0201036	-	SF-7M

SF

Tree shape with radius end

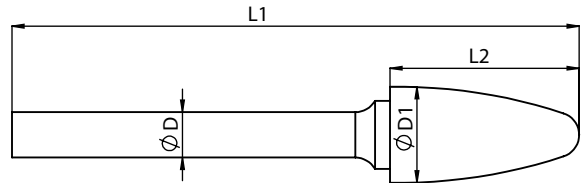

8mm Shank			Unit : mm		
Head Diameter	Head length	Overall Length	Tool No	Aluma Cut	CTI Number
ØD1	L2	L1		EDP No.	
9.5	19	69	TB2Z	-	
12.7	25	75	TB3Z	FAC0201288	
16	32	82	TB4Z	FAC0201010	
16	25	75	TB8Z	FAC0201029	SF-6M8
19	25	75	TB9Z	FAC0201037	SF-7M8

SG Tree shape with point end



CARBIDE BURRS



3mm Shank							Unit : mm
Head Diameter	Head length	Overall Length	Tool No	Standard cut	Supreme cut	Deluxe cut	CTI Number
ØD1	L2	L1		EDP No.	EDP No.	EDP No.	
3	16	38	MT1	FAC0200694	FAC0200697	FAC0200698	SG-41M
3	16	38	MT2	FAC0200700	FAC0200701	FAC0200703	
3	12.7	38	MT4	FAC0200708	FAC0200709	FAC0200710	
3	6	38	MT5	FAC0200711	FAC0200712	FAC0200713	SG-44M
3	8	75	MT6	FAC0200252	FAC0201253	FAC0200254	SG-41
6.3	10	38	MT3	FAC0200704	FAC0200705	FAC0200706	SG-51M

6mm Shank							
6	19	50	T1	FAC0200887	FAC0200888	FAC0200889	SG-1M
6	19	169	T1L2	FAC0200895	FAC0200896	FAC0200897	SG-1ML6
6.3	16	66	T7	FAC0200953	FAC0200954	FAC0200955	SG-1M
8	19	69	T5	FAC0200941	FAC0200942	FAC0200943	SG-2M
9.5	19	69	T2	FAC0200902	FAC0200903	FAC0200905	SG-3M
9.5	19	169	T2L2	FAC0200909	FAC0200910	FAC0200911	SG-3ML6
12.7	25	75	T3	FAC0200915	FAC0200920	FAC0200922	SG-5M
12.7	25	175	T3L2	FAC0200927	FAC0200928	FAC0200929	SG-5ML6
16	32	82	T4	FAC0200932	FAC0200934	FAC0200936	SG-6M
16	25	75	T6	FAC0200947	FAC0200949	FAC0200951	
19	25	75	T8	FAC0200956	FAC0200958	FAC0200960	SG-7M

SG

Tree shape with point end

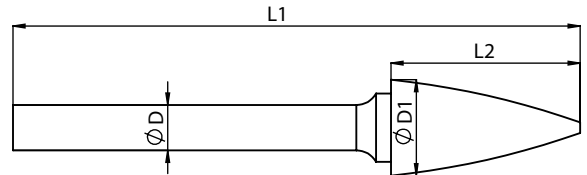

Unit : mm

8mm Shank			Tool No	Standard cut	Supreme cut	Deluxe cut	CTI Number
Head Diameter	Head length	Overall Length		EDP No.	EDP No.	EDP No.	
Ø D1	L2	L1					
9.5	19	69	T2Z	-	FAC0200904	-	
12.7	25	75	T3Z	FAC0200916	FAC0200921	FAC0201294	
16	32	82	T4Z	FAC0200933	FAC0200934	FAC0200935	SG-6ML8
16	25	75	T6Z	FAC0200948	FAC0200950	FAC0200952	
19	25	75	T8Z	FAC0200957	FAC0200959	FAC0200961	SG-7M8



6mm Shank			Tool No	Aluma Cut	CTI Number
Head Diameter	Head length	Overall Length		EDP No.	
Ø D1	L2	L1			
8	19	69	T5	FAC0201346	SG-2M
9.5	19	69	T2	FAC0201347	SG-3M

SH

Flame shape

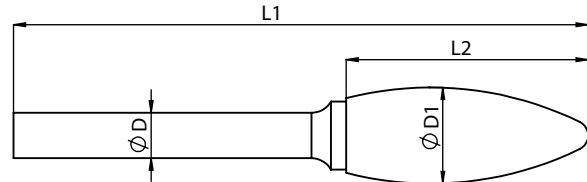

CARBIDE BURRS



Unit : mm

3mm Shank			Tool No	Standard cut	Supreme cut	Deluxe cut	CTI Number
Head Diameter	Head length	Overall Length		EDP No.	EDP No.	EDP No.	
ØD1	L2	L1					
3	6.3	38	MF1	FAC0200633	FAC0200634	FAC0200635	SH-41M
3	6.3	50	MF1L	FAC0200636	FAC0200637	FAC0200638	SH-41ML2
6.3	16	44	MF2	FAC0201242	-	-	

6mm Shank			Tool No	EDP No.	EDP No.	EDP No.	CTI Number
Head Diameter	Head length	Overall Length					
6.3	16	50	F1	FAC0200400	FAC0200401	FAC0200402	SH-1M
8	19	69	F2	FAC0200403	FAC0200404	FAC0200405	SH-2M
9.5	25	75	F3	FAC0200410	FAC0200411	FAC0200413	SH-3M
12.7	32	82	F4	FAC0200416	FAC02006418	FAC0200420	SH-5M
12.7	32	182	F4L2	FAC0200421	FAC0200422	FAC0200423	SH-5ML6
16	34	84	F5	FAC0200428	FAC0200430	FAC0201279	SH-6M
19	41	91	F6	FAC0200432	FAC0200434	FAC0200436	SH-7M

8mm Shank			Tool No	EDP No.	EDP No.	EDP No.	CTI Number
Head Diameter	Head length	Overall Length					
12.7	32	82	F4Z	FAC0200417	FAC0200419	FAC0201239	
16	34	84	F5Z	FAC0200429	FAC0200431	-	SH-6M8
19	41	91	F6Z	FAC0200433	FAC0200435	FAC0200437	SH-7M8



Unit : mm

6mm Shank			Tool No	Aluma Cut	Coarse Cut	CTI Number
Head Diameter	Head length	Overall Length		EDP No.	EDP No.	
ØD1	L2	L1				
8	19	69	F2	FAC0200409	-	SH-2M
9.5	25	65	F3	FAC0200415	FAC0201423	SH-3M
12.7	32	82	F4	FAC0200425	-	SH-5M

SL

Cone with radius burr

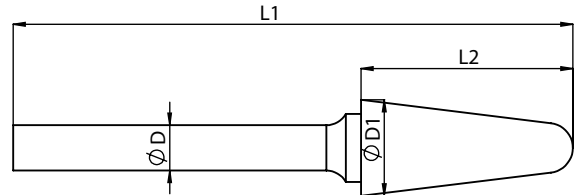

Unit : mm

3mm Shank

Head Diameter	Head length	Overall Length	Angle	Tool No	Standard cut	Supreme cut	Deluxe cut	CTI Number
					EDP No.	EDP No.	EDP No.	
ØD1	L2	L1	Degree					
3	8	38	10	MK1	FAC0200639	FAC0200641	FAC0200642	
3	9.5	38	8	MK1L	FAC0200643	FAC0200644	FAC0200645	SL-41M
3	12.7	38	8	MK3	FAC0200650	FAC0200651	FAC0200652	SL-42M
6.3	12.7	38	10	MK2	FAC0200646	FAC0200648	FAC0200649	SL-51M

6mm Shank

6.3	16	50	14	K0	FAC0200438	FAC0200439	FAC0201311	SL-1M
9.5	19	69	16	K1	FAC0200442	FAC0200443	FAC0200445	
9.5	26	76	14	K6	FAC0200494	FAC0200495	FAC0200496	SL-3M
12.5	30	85	17	K4	FAC0200480	FAC0200481	FAC0200482	
12.7	19	69	24	K2	FAC0200454	FAC0200456	FAC0200458	
12.7	28	78	14	K7	FAC0200501	FAC0200502	FAC0200504	SL-4M
16	33	83	17	K3	FAC0200468	FAC0200470	FAC0200472	
16	33	83	14	K8	FAC0200507	FAC0200509	FAC0200511	SL-5M
19	40	90	14	K5	FAC0200486	FAC0200488	FAC0200490	SL-7M
4	10	60	26	GD-1	FAC0201141	-	-	
3	8.5	68	10	GD-2	FAC02001258	-	-	
3	13	58	26	GD-3	FAC0201259	-	-	
3.8	19	69	35	GD-4	FAC0201142	-	-	

SL

Cone with radius burr

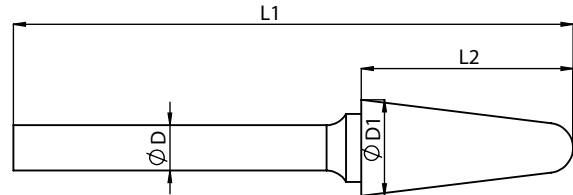

CARBIDE BURRS

8mm Shank



Unit : mm

Head Diameter	Head length	Overall Length	Angle	Tool No	Standard cut	Supreme cut	Deluxe cut	CTI Number
ØD1	L2	L1	Degree		EDP No.	EDP No.	EDP No.	
12.7	19	69	24	K2Z	FAC0200455	FAC0200457	FAC0200459	
16	33	83	17	K3Z	FAC0200469	FAC0200471	FAC0200473	
16	33	83	14	K8Z	FAC0200508	FAC0200510	FAC0200512	SL-5M8
19	40	90	14	K5Z	FAC0200487	FAC0200489	FAC0200491	SL-7M8

6mm Shank



Head Diameter	Head length	Overall Length	Angle	Tool No	Aluma Cut	Coarse Cut	CTI Number
ØD1	L2	L1	Degree		EDP No.	EDP No.	
6.3	16	66	14	K0	FAC0201344	-	SL-1M
9.5	19	69	16	K1	FAC0200453	FAC0201424	
9.5	26	76	14	K6	FAC0201226	-	SL-3M
12.5	30	80	17	K4	FAC0200485	-	
12.7	19	69	24	K2	FAC0200467	FAC0201425	
12.7	28	78	14	K7	-	FAC0201426	SL-4M
16	33	83	17	K3	FAC0201238	-	

8mm Shank

Head Diameter	Head length	Overall Length	Angle	Tool No	Aluma Cut	CTI Number
ØD1	L2	L1	Degree		EDP No.	
12.7	19	69	24	K2Z	FAC0201166	
16	33	83	17	K3Z	FAC0200479	
19	40	90	14	K5Z	FAC0200493	SL-7M8

SM

Cone shaped burr

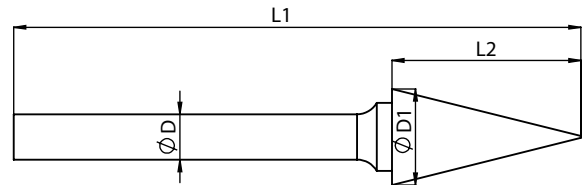

Unit : mm

3mm Shank				Tool No	Standard cut	Supreme cut	Deluxe cut	CTI Number
Head Diameter	Head length	Overall Length	Angle		EDP No.	EDP No.	EDP No.	
ØD1	L2	L1	Degree					
3	8	38	20	MA1	FAC0200513	FAC0200514	FAC0200515	
3	11	38	14	MA5	FAC0200521	FAC0200522	FAC0200523	SM-42M
3	16	38	7	MA6	FAC0200255	FAC0200256	FAC0200257	SM-43M
6.3	10.5	38	30	MA2	FAC0200518	FAC0200519	FAC0200520	SM-51M

6mm Shank				Tool No	Standard cut	Supreme cut	Deluxe cut	CTI Number
Head Diameter	Head length	Overall Length	Angle		EDP No.	EDP No.	EDP No.	
6	19	50	17	A1	FAC0200001	FAC0200002	FAC0200003	SM-2M
6.2	25	75	10	A10	FAC0200062	FAC0200063	FAC0200064	SM-3M
6.3	12.7	62	22	A13	FAC0200071	FAC0200072	FAC0200073	SM-1M
8	18	68	24	A8	FAC0200053	FAC0200054	FAC0200055	
9.5	20	70	24	A2	FAC0200012	FAC0200014	FAC0200016	
9.5	15	65	28	A11	FAC0200065	FAC0200066	FAC0200067	
9.5	9.5	60	90	A4	FAC0200036	FAC0200037	FAC0200038	SK-3M
10	18	68	28	A7	FAC0200050	FAC0200051	FAC0200052	SM-4M
12.7	25	75	28	A3	FAC0200022	FAC0200025	FAC0200027	
12.7	22	72	28	A12	FAC0200068	FAC0200069	FAC0200070	SM-5M
16	13	63	90	A5	FAC0200039	FAC0200040	FAC0200041	SK-6M
16	16	66	60	A6	FAC0200044	FAC0200046	FAC0200048	SJ-6M
16	25	75	31	A9	FAC0200056	FAC0200058	FAC0200060	SM-6M

SM

Cone shaped burr

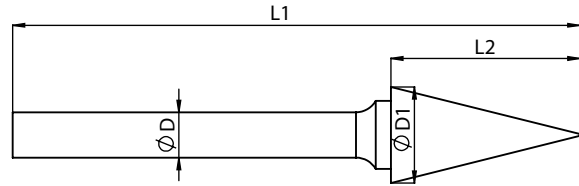

CARBIDE BURRS



Unit : mm

8mm Shank					Tool No	Standard cut	Supreme cut	Deluxe cut	CTI Number
Head Diameter	Head length	Overall Length	Angle	EDP No.		EDP No.	EDP No.		
ØD1	L2	L1	Degree						
9.5	20	70	24	A2Z	-	FAC0200015	-		
12.7	25	75	28	A3Z	-	FAC0200026	-		
16	16	66	60	A6Z	FAC0200045	-	-		
16	25	75	31	A9Z	FAC0200057	FAC0200059	FAC0200061	SM-6M8	



6mm Shank					Tool No	Coarse Cut	CTI Number
Head Diameter	Head length	Overall Length	Angle	EDP No.			
ØD1	L2	L1	Degree				
9.5	9.5	60	90	A4	FAC0201402	SK-3M	
16	13	63	90	A5	FAC0201403	SK-6M	

SN

Inverted cone shape burrs



3mm Shank					Unit : mm			CTI Number
Head Diameter	Head length	Overall Length	Angle	Tool No	Standard cut	Supreme cut	Deluxe cut	
ØD1	L2	L1			EDP No.	EDP No.	EDP No.	
3	8.5	38	10	MA3	FAC0200530	FAC0200531	FAC0200532	SN-42M
6.3	8	38	15	MA4	FAC0200533	FAC0200535	FAC0200536	

6 mm Shank					Unit : mm			CTI Number
Head Diameter	Head length	Overall Length	Angle	Tool No	Standard cut	Supreme cut	Deluxe cut	
ØD1	L2	L1			EDP No.	EDP No.	EDP No.	
6.3	8	58	10	N1	FAC0200538	FAC0200539	-	SN-1M
12.7	12.7	62	16	N4	FAC0200540	FAC0200541	-	SN-4M



RIM

Rim shape burrs

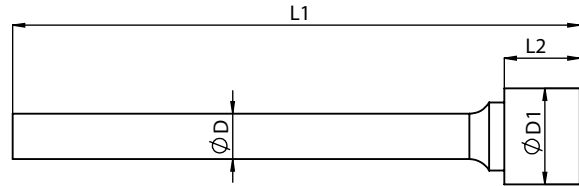

CARBIDE BURRS



6mm Shank			Unit : mm			
Head Diameter	Head length	Overall Length	Tool No	Standard cut	Supreme cut	Deluxe cut
ØD1	L1	L		EDP No.	EDP No.	EDP No.
9.5	2	52	R1	FAC0200786	FAC0200787	FAC0200788
12.7	10	60	R3	FAC0200796	FAC0200797	FAC0200798
15	4	54	R4	FAC0200801	FAC0200802	FAC0200803
19.1	6	56	R2	FAC0200789	FAC0200790	FAC0200791



6mm Shank			Tool No	Aluma cut
Head Diameter	Head length	Overall Length		EDP No.
ØD1	L1	L		
12.7	10	60	R3	FAC0200800
19.1	6	56	R2	FAC0200795



Burr Sets



BURR SET - 6 MM SHANK

BS1* - C8, B6, S4, TB3, T3, F4, K2, A3

(Dia 12.7 > Cylindrical, Cylindrical - Radius End, Ball, Tree Radius end, Tree, Flame, Cone-Radius End, Cone Shapes)

BS2* - C4, B3, S3, TB2, T2, F3, K6, A11

(Dia 9.5 > Cylindrical, Cylindrical - Radius End, Ball, Tree Radius end, Tree, Flame, Cone-Radius End, Cone Shapes)

BURR SET - 3 MM SHANK

MINIBS1* - MC1, MC5, MB0, MB1, MS0, M01, MTB2, MT5, MF1, MK3, MA5, MA3

(Dia 3.0 > Cylindrical, Cylindrical - Radius End, Ball, Oval, Tree Radius end, Tree, Flame, Cone-Radius End, Cone, Inverted Cone Shapes)

* While ordering please specify the FLUTING STYLE - Standard Cut / Supreme Cut (Double Cut).

CARBIDE BURRS NOMENCLATURE

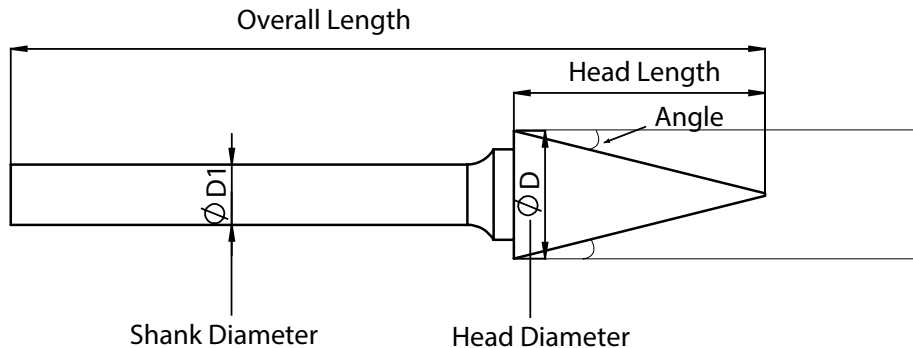

TYPE OF CUTS



Standard Cut (Single Cut):

This flute structure is designed for superior material removal and general purpose application. These can be used on Steel, Steel alloys, Cast Iron, Stainless Steel, Hard Bronze and Copper. Produces longer chips.



Supreme Cut (Double Cut / Cross Cut):

This burr allows for efficient stock removal in the harder materials. Its design reduces tool chatter and breaks the chips into granular shapes. These smaller chips also help to eliminate loading on the flutes. This design helps to have better control on the burr and grinder.



Deluxe Cut (Diamond Cut):

This design of tool is like triangular style of point, which produces extremely small chips (powder like chips). The cut eliminates pulling action of the main cut, and offers the operator good control over the tool and produces excellent finish. Effective in heat treated Steels and Tough alloy steels.



Aluma Cut:

Designed for rapid stock removal on Non-ferrous materials. Recommended to work on Aluminium, Zinc alloy, Hand rubber and Wood.

MATERIAL APPLICATION

Material Groups			Application	Cut Type				
				Standard	Supreme	Deluxe	Aluma	Coarse
Steel and Steel castings	Non Hardened, non heat treated steels upto 1200 N/mm ² (<35 HRC)	Constructional steels Carbon steels Tool steels Non-alloyed steels Case-hardened steels Steel castings	Coarse machining = high stock removal	X	X			
			Fine machining - eg: deburring			X		
	Hardened, heat treated steels exceeding 1200 N/mm ² (>35 HRC)	Tool steels Tempering steels Alloyed steels Steel castings	Coarse machining = high stock removal	X	X			
			Fine machining - eg: deburring			X		
High-grade steels	Stainless steels	Austenitic and ferritic high-grade steels	Coarse machining = high stock removal					X
			Fine machining - eg: deburring			X		
Non - ferrous metals	Soft non-ferrous metals	Aluminium alloys Brass Copper Zinc	Coarse machining = high stock removal				X	
			Fine machining - eg: deburring				X	
	Hard non-ferrous metals	Bronze Titanium / titanium alloys Very hard aluminium alloys (high Si content)	Coarse machining = high stock removal	X	X			
			Fine machining - eg: deburring			X		
	Heat resisting alloys	Nickel based alloys NiCo alloys (aircraft engine and turbine construction)	Coarse machining = high stock removal	X	X			
			Fine machining - eg: deburring			X		
Cast Iron		Grey Cast Iron Spheroidal Graphite cast iron	Coarse machining = high stock removal	X	X			
			Fine machining - eg: deburring			X		
Plastics / Other materials		Fibre Reinforced plastics Thermoplastics hard rubber	Coarse machining = high stock removal				X	
			Fine machining - eg: deburring				X	



SPEED RECOMMENDATION CHART

Material	3mm	6mm	8mm	10mm	12mm	16mm	20mm	25mm
Steel	60-90	30-45	25-35	20-30	15-25	10-18	10-14	8-10
Hardened / Tool Steel	30-40	15-20	10-15	10-15	8-10	5-8	4-7	3-5
Stainless Steel	30-50	15-25	12-20	10-15	9-12	7-10	5-7	4-5
Nickel / Titanium	30-40	15-20	10-15	10-15	8-10	5-8	4-7	3-5
Cast Iron	60-90	30-45	25-35	20-30	15-20	10-18	10-14	8-10
Aluminium / Plastics	30-90	15-60	12-50	10-50	8-35	6-30	5-20	4-15
Brass	40-50	20-30	15-20	13-17	10-15	8-12	6-8	5-6
Copper	30-90	15-60	12-50	10-50	8-35	6-30	5-20	4-15
Zinc	60-90	30-45	25-35	20-30	15-25	10-18	10-14	8-10

The table lists recommended rotational speeds (RPM) as a function of burr diameter.

SAFETY NOTE:-

Tools with long shanks must be placed on the workpiece, or inserted into the bore or groove, before the power source is switched on. For safety reasons we urge you to reduce idling speeds (RPM) by up to one-third from the values stated.

RECOMMENDATIONS FOR USE:

TOTEM Tungsten Carbide Burrs are designed for machining materials of virtually any strength; the superior performance reflects an optimum combination of key parameters such as shape, number of flutes, spiral angle, rake angle and concentricity. The precise concentricity of TOTEM tungsten carbide burrs

- Ensures an improved protection of operator safety and health
- Reduces power tool wear
- Provides smooth operating behaviour
- Prevents chatter marks

An optimum power output and RPM of the power source (air-powered or electric machine, flexible shaft system) are necessary conditions for an economically efficient use of tungsten carbide burrs. We therefore recommend you to observe the following rules:

- Work with maximum RPM. Do not use speeds below 3000 RPM except in special cases (eg: on stationary machines or when countersinking with fully immersed burr).
- Chucks and collets must be absolutely concentric to avoid chipping. Tool runout and chatter will result in premature wear.
- Work with significantly reduced RPM on poorly heat conducting materials (eg: stainless steel, titanium alloys, etc.) to prevent tool damage. Avoid the typical blue Discoloration of the shank and the tool.
- In light cutting applications (deburring, chamfering, light surface work) the tool speed may be increased up to twice indicated rate.
- When machining very sticky materials, the use of a suitable lubricant (grease, kerosene, chalk or similar) is recommended to prevent loading.

DIVISIONAL SALES OFFICES ADDRESS / PH. NO.

AHMEDABAD

1st floor, Pranvijay building,
Opp. Bata Showroom, Nr. Times of India, Ashram road,
Ahmedabad - 380007
Telephone: +91 (0) 79 26587769

BENGALURU

#3rd floor, Classic Building, 24 Richmond road
Bengaluru-560025
Telephone: +91 (0) 80 43230129
Fax: +91 (0) 80 43230110

CHANDIGARH

House No. 527, Sector 11B,
Chandigarh - 160002
Telephone: +91 (0) 9779177545

CHENNAI

Catholic Centre, 1st Floor,
108, Armenian Street,
Chennai - 600001
Telephone: +91 (0) 44 25389890/95,
Fax: +91 (0) 44 25360872

NEW DELHI

9-10/3, Laxman House,
Asaf Ali Road,
New Delhi - 110002
Telephone: +91 (0) 11 43000121-129
Fax: +91 (0) 11 43000130

KOLKATA

Royal insurance building,
5&7 N.S Road, Ground Floor,
Kolkata-700001
Telephone: +91 (0) 33 22622947

MUMBAI

Saki-Powai Road
Chandivali Andheri East
Mumbai- 400072
Telephone: +91 (0) 22 28471861

PUNE

4th Floor, Bhosale Heights,
Opp. Deendayal Hospital, Shivajinagar,
Pune- 411005
Telephone: +91 (0) 20 41359108

SECUNDERABAD

5th floor, P.V.S Mansion, Somasundaram Street,
Beside Manju Theatre, S.D Road,
Secunderabad-500003
Telephone: +91 (0) 40 27814585; +91 (0) 40 27844967

AURANGABAD

B-13, MIDC, Waluj,
Aurangabad - 431133
Telephone: +91 (0) 240 2553422

INTERNATIONAL SALES

Saki-Powai Road
Chandivali Andheri East
Mumbai- 400072
Telephone: +91 (0) 22 28471861



High Performance Cutting Tools



Forbes & Company Limited

Saki Powai Road, Chandivali,
Mumbai 400 072, India

Phone: +91 22 2847 1861

Email: sales@forbes.co.in

Website: www.totem-forbes.com

