

2013/2014

Turning, drilling, threading,
milling, adaptors

_A COMPENDIUM OF EXPERTISE IN MACHINING

Supplementary Catalogue

**Supplement to the
General Catalogue 2012**

Concentrated expertise for machining.



Walter Supplementary catalogue + Walter General catalogue = complete tool range

These two catalogues contain the complete tool range of our three competence brands **Walter**, **Walter Titex** and **Walter Prototyp**. They contain all the precision tools you need in your production facilities for turning, boring, milling and threading.

We will be pleased to send you the General catalogue on request. Visit www.walter-tools.com or speak to one of our Walter field service employees.

Find what you're looking for without having to search – The Walter General catalogue is clearly arranged, easily read and readily understood.

With our tried and tested "Walter Select" search system, you can easily and quickly find the right tool for turning, drilling, threading and milling:

- You first select the appropriate subject area in the **Table of contents** of a section.
- You then find the appropriate tool in the **Programme overview** of a section.
- The **Walter Select** selection aid leads to the right tool without fail.

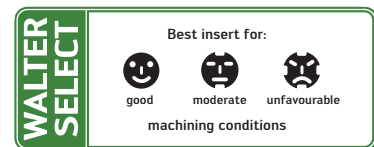

	P	M	K	N	S	H	O
uncoated	●	●	●	●	●		
TiN	●	●	●	●			

... and if you already know what you need, you just look it up in the **alphanumeric search index**.

You will find additional information for tools arranged in bars with cross references, for instance:

<p>Information on reconditioning can be found from page B-137.</p> <p>B-137</p>	<p>Adaptors from page G-2.</p> <p>G-2</p>	<p>Fitting instructions from page A 313 in the Walter General catalogue 2012.</p> <p>F 313*</p>
<p>Indexable inserts from page A-17.</p> <p>A-17</p>	<p>Assembly parts and accessories from page A 302 in the Walter General catalogue 2012.</p> <p>G 302*</p>	<p>Technical information from page A-286.</p> <p>A-286</p>

* **Please note:** the cross references in italics and with asterisks refer only to the Walter General catalogue 2012 – not to the Supplementary catalogue 2013 presented here.

Turning		Contents	A-1	A
		Indexable inserts	A-3	
		Toolholders for turning, grooving and threading	A-83	
		Technical information	A-120	

Drilling		Drilling and boring tools made from solid carbide and HSS		B
		Contents	B-1	
		Drilling and boring tools	B-2	
		Technical information	B-102	

Drilling and boring tools with indexable inserts		Contents	C-1	C
		Indexable inserts	C-3	
		Drilling and boring tools	C-30	
		Technical information	C-76	

Threading		Contents	D-1	D
		Tools for thread tapping, thread forming and thread milling	D-2	
		Technical information	D-140	

Milling		Milling cutters made from solid carbide, PCD and HSS		E
		Contents	E-1	
		Milling cutters	E-2	
		Technical information	E-82	

Milling cutters with indexable inserts		Contents	F-1	F
		Indexable inserts	F-3	
		Milling cutters	F-44	
		Technical information	F-92	

Adaptors and clamping units	Contents	G-1	G
	Walter Capto™ clamping units and adapters	G-10	
	Walter NC tools	G-18	
	Adaptors for ScrewFit, ConeFit™, HSK, SK	G-19	
	Technical information	G-41	

General	Contents	H-1	H
	General technical information	H-2	
	Alphanumeric search index	H-17	



CONTENTS

Turning







	Page	
Indexable inserts for turning and grooving	Product range overview	A-3
	Designation key for ISO indexable inserts	A-4
	Walter Select – Turning	A-8
	Walter indexable inserts for turning – Carbide	A-15
	Walter indexable inserts for turning – CBN and ceramic	A-56
	Designation key for cutting inserts	A-62
	Walter Select – Grooving	A-64
	Walter cutting inserts for grooving	A-69
	Walter turning tools	System overview – External machining
Product range overview – External machining		A-84
Turning toolholders for external machining		A-88
System overview – Internal machining		A-101
Product range overview – Internal machining		A-102
Turning toolholders for internal machining		A-104
Walter Cut grooving tools	Walter Cut system overview	A-112
	Walter Cut product range overview	A-114
	Tools for grooving, parting off and recessing	A-117
Technical information	Cutting data – Turning	A-120
	Cutting tool material application tables – Turning	A-130
	Geometry overview of turning inserts	A-132
	Application information – Turning	A-137
	Cutting data – Grooving, recessing and parting off	A-140
	Cutting tool material application tables – Grooving	A-144
	Geometry overview of cutting inserts	A-145
	Application information – Grooving	A-150





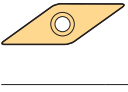

Product range overview of indexable inserts for turning, grooving and threading





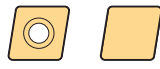
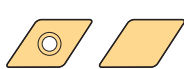

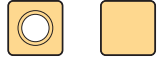
ISO turning – Carbide

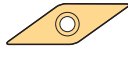
Insert shape	Description	Page
 C <u>Wiper</u>	Negative basic shape Positive basic shape	A-15 A-42
 D <u>Wiper</u>	Negative basic shape Positive basic shape	A-21 A-45
 R	Positive basic shape	A-47
 S	Negative basic shape Positive basic shape	A-26 A-49
 T	Negative basic shape Positive basic shape	A-32 A-50
 V	Negative basic shape Positive basic shape	A-36 A-52
 W <u>Wiper</u>	Negative basic shape Positive basic shape	A-37 A-54

ISO turning – CBN and ceramic

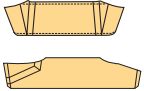
Insert shape	Description	Page
 C	Negative basic shape Positive basic shape	A-56 A-59
 D	Negative basic shape Positive basic shape	A-57 A-59
 R	Negative basic shape Positive basic shape	A-57 A-60
 S	Negative basic shape	A-58
 T	Negative basic shape Positive basic shape	A-58 A-60
 V	Positive basic shape	A-61

Grooving

Insert shape	Description	Page
 GX	Walter Cut GX grooving inserts	A-69
 SX	Walter Cut SX grooving inserts	A-80
 LX	Walter Cut LX grooving inserts	A-79
 FX	Walter Cut FX grooving inserts	A-81

Threading

Insert shape	Description	Page
 NTS	Walter NTS thread cutting inserts, full profile Walter NTS thread cutting inserts, partial profile	A 67* A 75*

* The pages indicated in italics refer to the Walter General catalogue 2012.

ISO 1832 designation key for indexable inserts for turning

Example 1

C	N	M	G	12	04	08	-	M	K	5
1	2	3	4	5	6	7		12	13	14

1	
Insert shape	
A	M
B	O
C	P
D	R
E	S
H	T
K	V
L	W

2	
Clearance angle	
A	F
B	G
C	N
D	P
E	

3			
Tolerances			
Permissible deviation in mm for			
	d	m	s
	A	± 0,025	± 0,005
	C	± 0,025	± 0,013
	E	± 0,025	± 0,025
	F	± 0,013	± 0,005
	G	± 0,025	± 0,025
	H	± 0,013	± 0,013
	J ¹	± 0,05-0,15 ²	± 0,005
	K ¹	± 0,05-0,15 ²	± 0,013
	L ¹	± 0,05-0,15 ²	± 0,025
	M	± 0,05-0,15 ²	± 0,08-0,20 ²
	N	± 0,05-0,15 ²	± 0,08-0,20 ²
	U	± 0,08-0,25 ²	± 0,13-0,38 ²

¹ Inserts with ground secondary cutting edges
² depending on insert size (see ISO standard 1832)

5														
Cutting edge length l [mm]														
Inner circle diameter d	C		D		R	S		T		V		W		
	mm	inches	Size	l	Size	Size	Size	l	Size	l	Size	l		
3,97	5/32								06	6,9				
5	0,197				05							03	3,8	
5,56	7/32								09	9				
6	0,236				06									
6,35	2/8	06	6,45	07	7,75	06 ¹			11	11	11	11	04	4,3
8	0,315				08								05	5,29
9,525	3/8	09	9,67	11	11,63	9	09	9,525	16	16,5	16	16,5	06	6,5
10	0,394				10									
12	0,472				12									
12,7	4/8	12	12,9	15	15,5	12 ¹	12	12,7	22	22			08	8,7
15,875	5/8	16	16,1				15	15,875	27	27			10	10,86
16	0,63				16									
17,46	11/16												12	11,64
19,05	6/8	19	19,3			19	19	19,05						
20	0,787				20									
25	0,984				25									
25,4	8/8	25	25,8			25 ¹	25	25,4						
32	1,26				32									

6	
Insert thickness s [mm]	
	01 s = 1,59
	02 s = 1,98
	03 s = 2,78
	04 s = 3,18
	05 s = 3,97
	06 s = 4,76
	07 s = 5,56
	08 s = 7,94
	09 s = 9,52

¹ Version in inches

Example 2

T	N	M	A	16	04	08	T	020	20
1	2	3	4	5	6	7	8	10	11

4			
Machining and fastening features			
A		H	 $\beta = 70-90^\circ$
B	 $\beta = 70-90^\circ$	J	 $\beta = 70-90^\circ$
C	 $\beta = 70-90^\circ$	M	
F		N	
G		Q	 $\beta = 40-60^\circ$
		R	
		T	 $\beta = 40-60^\circ$
		U	 $\beta = 40-60^\circ$
		W	 $\beta = 40-60^\circ$
		X	Drawing or precise description of indexable insert required.

7	
Corner radius (r) [mm]	
	01 r = 0,1
	02 r = 0,2
	04 r = 0,4
	08 r = 0,8
	12 r = 1,2
	16 r = 1,6
	24 r = 2,4
00	for diameters converted from imperial units to mm
M0	for diameters in metric units

8	
Edge formation	
E	
F	
T	
S	

9	
Cutting direction	
	R
	L
	N

10	
Chamfer width	
	010 = 0,10 mm
	020 = 0,20 mm
	025 = 0,25 mm
	070 = 0,70 mm
	150 = 1,50 mm
	200 = 2,00 mm

11	
Chamfer angle	
	15 = 15°
	20 = 20°

Geometry designation keys for indexable inserts for turning

Geometry index

C	N	M	G	12	04	08	-	M	K	5
1	2	3	4	5	6	7		12	13	14

New geometry index (valid from 09/2011)

12	13	14
Chip breaking area	Material	Feed/cut depth within chip-breaking area
<p> F Finishing M Medium machining R Roughing H Heavy cutting </p>	<ul style="list-style-type: none"> P Steel M Stainless steel K Cast iron N NF metals S Difficult-to-cut materials H Hard materials U Universal W Wiper 	<p>high</p> <p>9</p> <p>8</p> <p>7</p> <p>6</p> <p>5</p> <p>4</p> <p>3</p> <p>2</p> <p>1</p> <p>low</p>

Old geometry index

12	13	14
Basic shape	Chip breaking area	Cutting edge type
<p>N </p> <p>P </p>	<p> F Finishing S Semi-finishing M Medium machining R Roughing </p>	<p>1 fine</p> <p>4 medium</p> <p>9 robust</p> <p>S ISO S materials high temperature alloys</p> <p>T ISO S titanium materials</p>

Designation key for cutting tool materials made from carbide – Turning

Example

W	M	P	20	S
Walter	1	2	3	4

1
1. Primary application or coating type
<p>P Steel</p> <p>M Stainless steel</p> <p>K Cast iron</p> <p>N NF metals</p> <p>S Difficult-to-cut materials</p> <p>H Hard materials</p> <p>A CVD aluminium coating</p> <p>X PVD coating</p>

2
2. Primary application
<p>P Steel</p> <p>M Stainless steel</p> <p>K Cast iron</p> <p>N NF metals</p> <p>S Difficult-to-cut materials</p> <p>H Hard materials</p>

3
ISO application range
<div style="display: flex; align-items: center;"> <div style="margin-right: 20px;"> <p style="text-align: center;">Wear resistance</p> <p>01</p> <p>05</p> <p>10</p> <p>20</p> <p>21</p> <p>23</p> <p>30</p> <p>32</p> <p>33</p> <p>43</p> </div> <div style="margin-right: 20px;"> </div> <div> <p style="text-align: center;">Toughness</p> </div> </div>
<p>Cutting tool materials for:</p> <p>0 ISO turning</p> <p>1 ISO turning</p> <p>5 ISO turning</p> <p>2 Threading</p> <p>3 Grooving</p>

4
Generation
<p>S Tiger-tec® Silver</p>

Walter Select for turning inserts

Step by step to the right indexable insert

STEP 1

Determine the **material** to be machined from page H 8 in the Walter General catalogue 2012.

Note the machining group that corresponds to your material e.g.: P10.

Code letter	Machining group	Groups of the materials to be machined	
P	P1–P15	Steel	All types of steel and cast steel, with the exception of steel with an austenitic structure
M	M1–M3	Stainless steel	Stainless austenitic steel, austenitic-ferritic steel and cast steel
K	K1–K7	Cast iron	Grey cast iron, cast iron with spheroidal graphite, malleable cast iron, cast iron with vermicular graphite
N	N1–N10	NF metals	Aluminium and other non-ferrous metals, non-ferrous materials
S	S1–S10	High temperature alloys and titanium alloys	Heat resisting special alloys based on iron, nickel and cobalt, titanium and titanium alloys
H	H1–H4	Hard materials	Hardened steel, hardened cast iron materials, chilled cast iron
O	O1–O6	Other	Plastics, fibre glass and carbon fibre reinforced plastics, graphite

STEP 2

Determine the **basic shape** of the indexable insert:

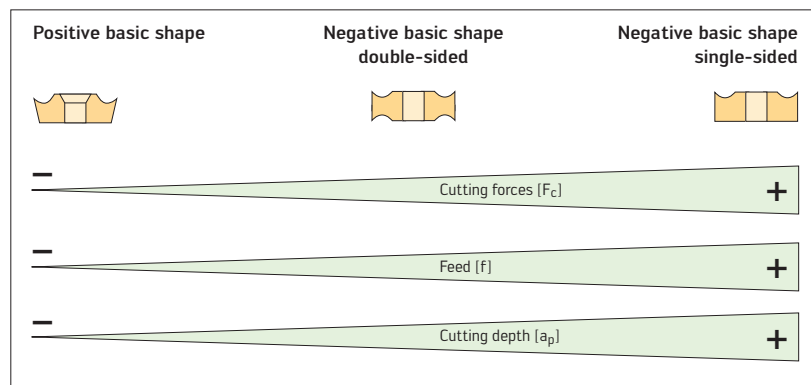

STEP 3

Select the **machining conditions**:

Type of workpiece	Machine stability, clamping system and workpiece		
	very good	good	moderate
Smooth cut Premachined surface			
Casting or forged skin Variable cutting depths			
Interrupted cuts			

STEP 4

Determine the **insert geometry** via the cutting depth (a_p) and the feed (f).

Geometries for

- P Steel see page A-10
- M Stainless steel see page A-11
- K Cast iron see page A-12
- N NF metals see page A-14
- S High temperature alloys see page A-13
- H Hard materials see page A-14

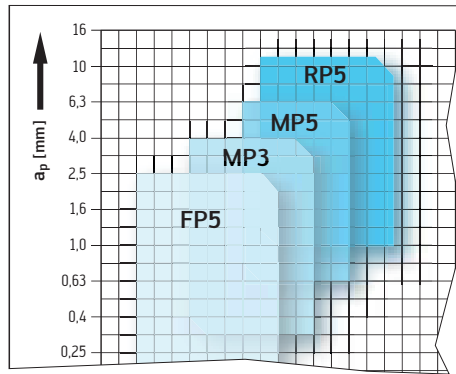

STEP 5

Overview of catalogue page on which you will find the selected **geometry** in the relevant **basic shape**.

Geometry	C	D	R	S	T	V	W
	Page	Page	Page	Page	Page	Page	Page
NF*	A-15	A-21					A-37
NF4	A-15	A-21			A-32		A-37
FP5	A-15	A-21		A-26	A-32	A-36	A-37
NM*	A-15	A-22					A-37
MP3	A-16	A-22		A-26	A-32	A-36	A-38
NM4	A-16	A-23		A-26	A-32	A-36	A-37
MP5	A-16	A-23		A-26	A-32		A-37
NM6	A-17			A-27	A-33		A-39
NM9	A-17	A-24		A-28	A-34		A-40

On the specified catalogue page you will find the cutting tool material recommendation, the feed value (f) and the cutting depth (a_p).

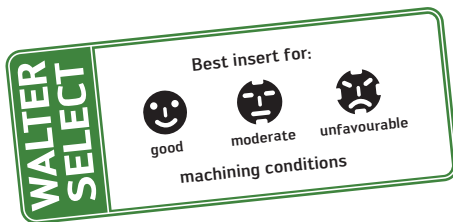

Negative basic shape CNGG/CNMG/CNMA/CNMM

Tiger-tec® Silver

Indexable inserts

Designation	r mm	f mm	ap mm	P		M		K		S		HW
				HC	HC	HC	HC	HC	HC			
CNMG120404-NF	0.4	0.10 - 0.40	0.4 - 2.0	●	●	●	●	●	●	●	●	●
CNMG120408-NF	0.8	0.15 - 0.55	0.5 - 3.0	●	●	●	●	●	●	●	●	●
CNMG120404-NF*	0.4	0.08 - 0.17	0.4 - 1.0	●	●	●	●	●	●	●	●	●

STEP 6

Choose the **cutting data** for your selected indexable insert from the technical information, see page A-120 onwards.

Cutting data for turning inserts – Negative basic shape Carbide grades

Material group	Structure of main material groups and identification letters	Annealed	Bore hardness HB	Tensile strength R_{m} [N/mm²]	Machining group 1	Cutting material grades							
						Starting values for cutting speed v_c [m/min]							
						WPP10S		WPP20S		HC			
						f [mm/U]	f [mm/U]	f [mm/U]	f [mm/U]	f [mm/U]	f [mm/U]		
P	Unalloyed steel	C ≤ 0.25%	annealed	125	428	P1	●	●	●	●	●	●	●
		C > 0.25% - 0.55%	annealed	190	639	P2	●	●	●	●	●	●	●
		C > 0.25% - 0.55%	tempered	210	708	P3	●	●	●	●	●	●	●
		C > 0.55%	annealed	190	639	P4	●	●	●	●	●	●	●
		C > 0.55%	tempered	300	1013	P5	●	●	●	●	●	●	●
P	Low-alloyed steel	Free cutting steel (short-chipping)	annealed	220	745	P6	●	●	●	●	●	●	●
		annealed	175	591	P7	●	●	●	●	●	●	●	
		tempered	300	1013	P8	●	●	●	●	●	●	●	
		tempered	380	1282	P9	●	●	●	●	●	●	●	
P	High-alloyed steel and high-alloyed tool steel	annealed	200	675	P11	●	●	●	●	●	●	●	
		hardened and tempered	300	1013	P12	●	●	●	●	●	●	●	
		hardened and tempered	400	1361	P13	●	●	●	●	●	●	●	
P	Stainless steel			300		P14	●	●	●	●	●	●	

Walter Select – Steel machining ISO P

STEP 4

Determine the **indexable insert geometry** via the cutting depth (a_p) and the feed (f).

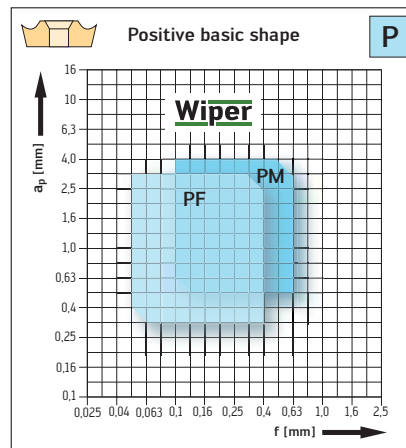
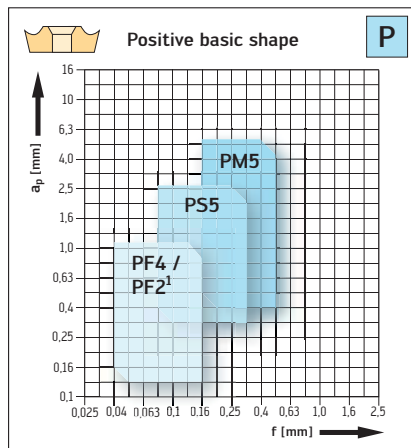
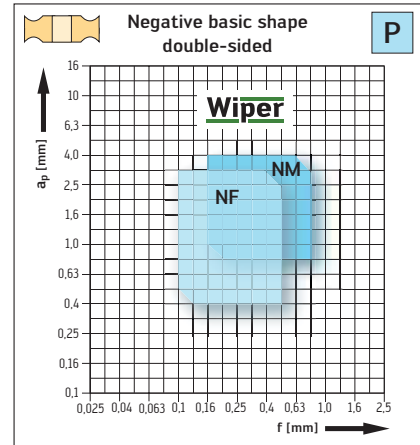
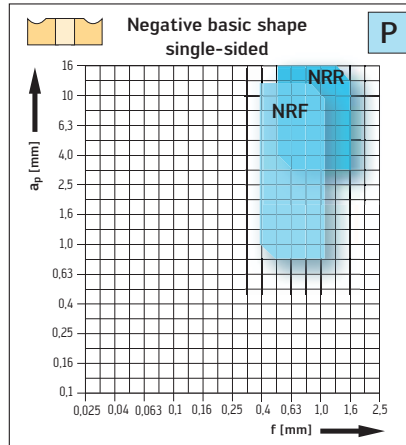
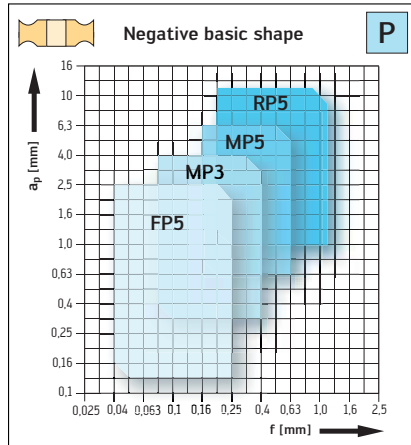

Wiper

You can find more technical information in the Walter General catalogue 2012 from page A 298 onwards.

You can find further fields of application for the geometries NM4, NM6, NM9 etc. in the Walter General catalogue from page A 17 onwards.

¹ Circumference fully ground

STEP 5

Overview of catalogue page on which you will find the selected **geometry** in the relevant **basic shape**.

Geometry	Basic shape						
	C	D	R	S	T	V	W
	Page	Page	Page	Page	Page	Page	Page
NF*	A-15	A-21					A-37
NF4	A-15	A-21			A-32		A-37
FP5	A-15	A-21		A-26	A-32	A-36	A-37
NM*	A-15	A-22					A-37
MP3	A-16	A-22		A-26	A-32	A-36	A-38
NM4	A-16	A-23		A-26	A-32	A-36	A-38
MP5	A-16	A-23		A-26	A-32		A-38
NM6	A-17			A-27	A-33		A-39
NM9	A-17	A-24		A-28	A-34		A-40
NR4	A-18			A-28	A-34		A-40
RP5	A-18	A-25		A-29	A-34		A-40
NRF	A-20	A-25		A-30	A-35		A-41
NRR	A-20			A-31	A-35		
PF*	A-42	A-45					A-54
PF4	A-42	A-45	A-47	A-49	A-50	A-52	A-54
PF5	A-42		A-47			A-52	
PS5	A-43	A-45		A-49	A-50	A-52	A-54
PM*	A-43	A-45					A-55
MOT			A-47				
PM5	A-43	A-46	A-48	A-49	A-51	A-53	A-55
HU6			A-48				
PR5			A-48				

* **Wiper**

Walter Select – Stainless steel ISO M

STEP 4

Determine the **indexable insert geometry** via the cutting depth (a_p) and the feed (f).

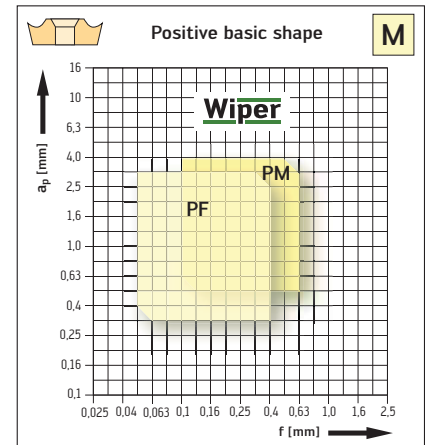
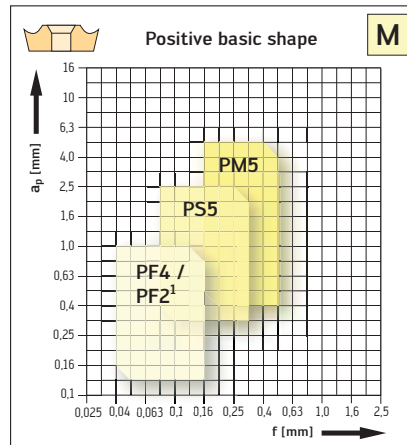
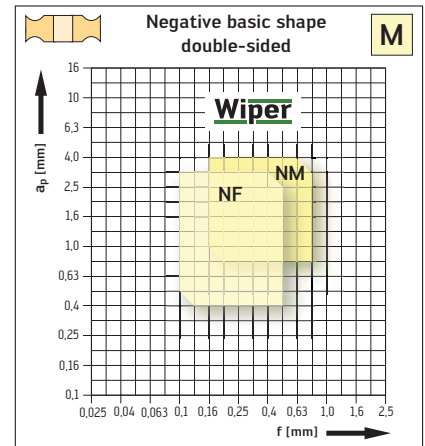
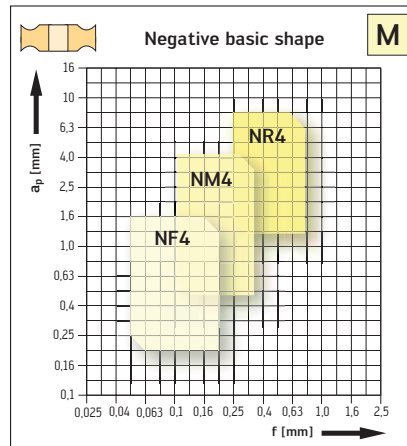

¹ circumference fully ground

Wiper

You can find more technical information in the Walter General catalogue 2012 from page A 298 onwards.

STEP 5

Overview of catalogue page on which you will find the selected **geometry** in the relevant **basic shape**.

Geometry	Basic shape						
	C	D	R	S	T	V	W
	Page	Page	Page	Page	Page	Page	Page
NF*	A-15	A-21					A-37
NF4	A-15	A-21		A-26	A-32		A-37
NM*	A-15						A-37
NM4	A-16	A-23		A-26	A-32	A-36	A-38
NR4	A-18	A-24		A-28	A-34		A-40
PF*	A-42	A-45					A-54
PF2	A-42	A-45		A-49	A-50	A-52	A-54
PF4	A-42	A-45	A-47	A-49	A-50	A-52	A-54
PS5	A-43	A-45		A-49	A-50	A-52	
PM*		A-45					
PM5	A-43	A-46	A-48	A-49	A-51	A-53	A-55

* **Wiper**

Walter Select – Cast iron machining ISO K

STEP 4

Determine the **indexable insert geometry** via the cutting depth (a_p) and the feed (f).

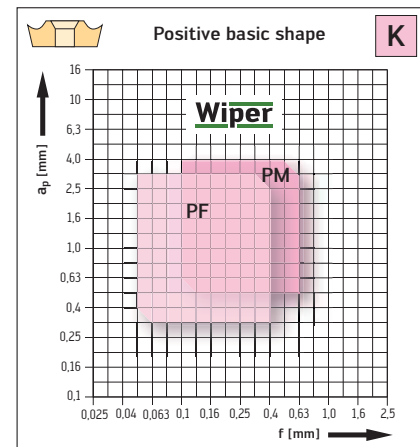
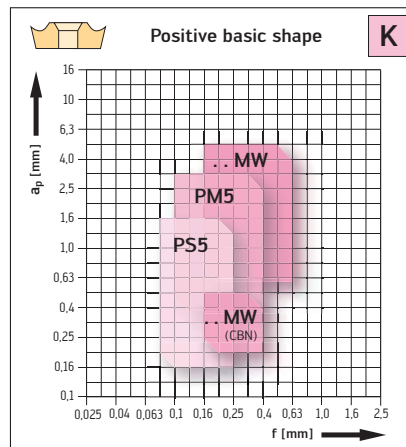
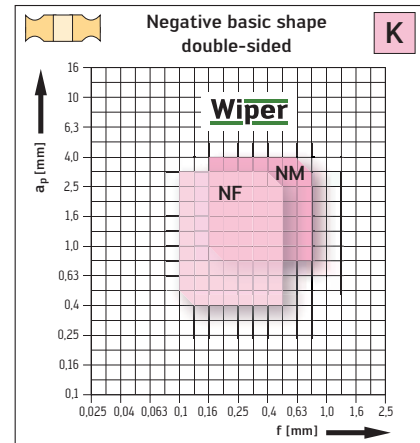
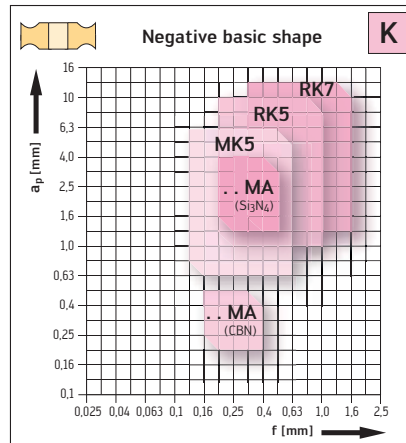

You can find further fields of application for the geometries NM5, NMA, T02020 etc. in the Walter General catalogue from page A 17 onwards.

Wiper

You can find more technical information in the Walter General catalogue 2012 from page A 298 onwards.

STEP 5

Overview of catalogue page on which you will find the selected **geometry** in the relevant **basic shape**.

Geometry	Basic shape						
	C	D	R	S	T	V	W
	Page	Page	Page	Page	Page	Page	Page
NF*	A-15	A-21					A-37
NM*	A-15	A-22					A-37
MK5	A-16	A-23			A-33	A-36	A-39
NM5	A-17	A-24		A-27	A-33	A-36	A-39
RK5	A-19	A-25		A-29	A-34	A-36	A-41
RK7	A-19	A-25		A-29	A-34		A-41
.. MA	A-19	A-25		A-30	A-35	A-36	A-41
T02020	A-20			A-30	A-35		A-41
.. MA ($\text{Si}_3\text{N}_4 + \text{CBN}$)	A-56	A-57		A-58			
PF*	A-42	A-45					A-54
PS5	A-43	A-45		A-49	A-50	A-52	A-54
PM*	A-43	A-45					A-55
PM5	A-43	A-46	A-48	A-49	A-51	A-53	A-55
HU6			A-48				
.. MW (CBN)	A-59	A-59			A-60	A-61	
.. MW	A-44	A-46		A-49	A-51	A-53	

Use NF*/PF*WPP01 grades

* **Wiper**

Walter Select – High-temperature and titanium alloys ISO S

STEP 4

Determine the **indexable insert geometry** via the cutting depth (a_p) and the feed (f).

Ni, Co, Fe-based alloys

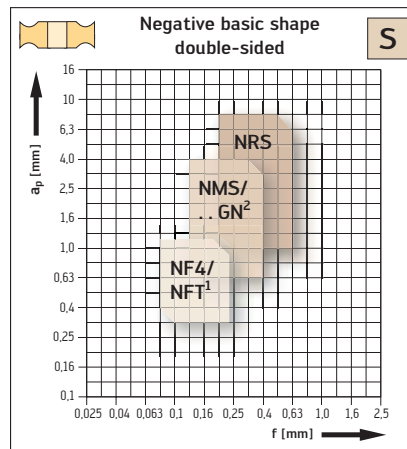

Titanium-based alloys

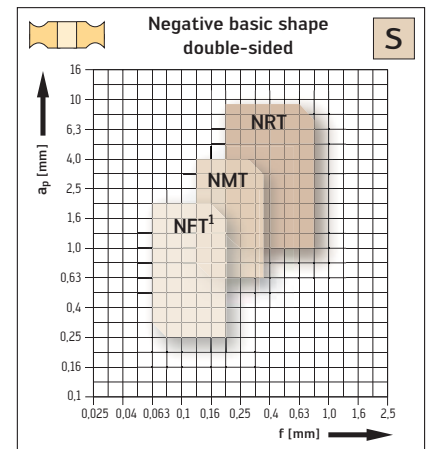

Ni, Co, Fe and titanium-based alloys

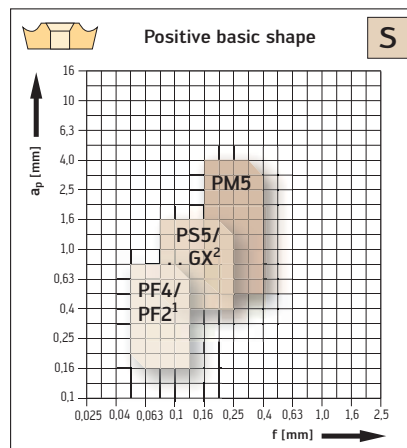

¹ circumference fully ground
² ceramic, WIS10/WWS20

STEP 5

Overview of catalogue page on which you will find the selected **geometry** in the relevant **basic shape**.

Geometry	Basic shape						
	C	D	R	S	T	V	W
	Page	Page	Page	Page	Page	Page	Page
NFT	A-15	A-21				A-36	
NF4	A-15	A-21		A-26	A-32		A-37
NMT	A-15	A-22			A-32		A-37
NMS	A-17	A-22			A-32	A-36	A-37
NRT	A-18			A-28			
NRS	A-18	A-24		A-28			A-40
.. GN ²	A-56	A-57	A-57	A-58			
PF2	A-42	A-45		A-49	A-50	A-52	
PF4	A-42	A-45	A-47	A-49	A-50	A-52	A-54
PS5	A-43	A-45		A-49	A-50	A-52	
PM5	A-43	A-46	A-48	A-49	A-51	A-53	A-55
.. GX ²			A-60				

Walter Select – ISO N NF metals

STEP 4

Determine the **indexable insert geometry** via the cutting depth (a_p) and the feed (f).

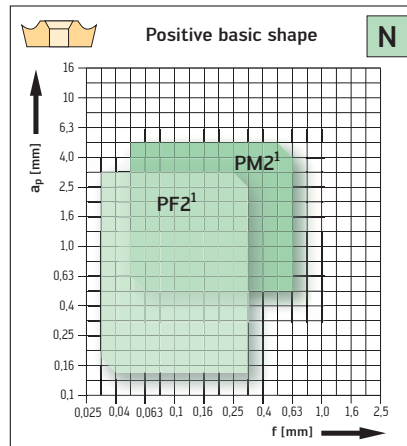

¹ circumference fully ground

STEP 5

Overview of catalogue page on which you will find the selected **geometry** in the relevant **basic shape**.

Geometry	Basic shape						
	C	D	R	S	T	V	W
	Page	Page	Page	Page	Page	Page	Page
PF2	A-42	A-45	A-47	A-49	A-50	A-52	A-54
PM2	A-43	A-46	A-47	A-49	A-51	A-52	A-55

Walter Select – Hard machining ISO H

STEP 4

Determine the **indexable insert geometry** via the cutting depth (a_p) and the feed (f).

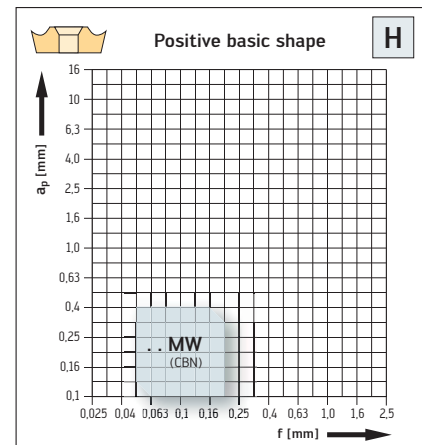
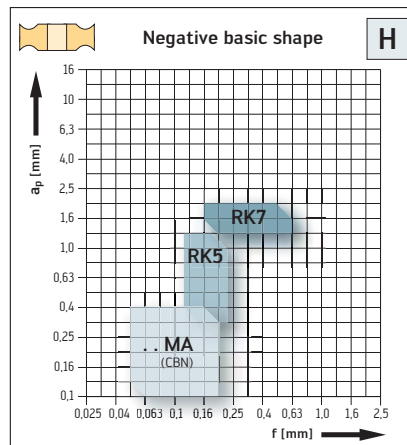

STEP 5

Overview of catalogue page on which you will find the selected **geometry** in the relevant **basic shape**.

Geometry	Basic shape						
	C	D	R	S	T	V	W
	Page	Page	Page	Page	Page	Page	Page
RK5*	A-19	A-25		A-29	A-34	A-36	A-41
RK7*	A-19	A-25		A-29	A-34		A-41
.. MA*	A-19	A-25		A-30	A-35	A-36	A-41
T02020*	A-20			A-30	A-35		A-41
.. MA (CBN)	A-56	A-57		A-58	A-58		
.. MW (CBN)	A-59	A-59			A-60	A-61	

* Use grade WKK10S / WAK10

Negative basic shape CNGG/CNMG/CNMA/CNMM

Tiger-tec® Silver

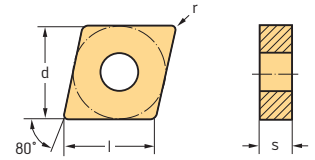

Indexable inserts

Designation	r mm	f mm	ap mm	P							M			K				S								
				WPP10S	WPP20S	WPP30S	WMP20S	HC		WPP01	WPP05	WPP10	WPP20	WPP30	WMP20S	HC		WSM30	WKK10S	WKK20S	WAK10	WAK20	WAK30	WSM10	WSM20	WSM30
CNMG120404-NF	0,4	0,10 - 0,40	0,4 - 2,0						☺	☺	☹			☹										☹		
	0,8	0,15 - 0,55	0,5 - 3,0						☺	☺	☹			☹										☹		
CNMG120404-NFT	0,4	0,08 - 0,17	0,4 - 1,0											☹									☹	☹	☹	
	0,8	0,10 - 0,20	0,5 - 2,0											☹									☹	☹	☹	
CNGG120404-NFT	0,4	0,06 - 0,15	0,3 - 1,5																						☹	
	0,8	0,08 - 0,18	0,4 - 2,0																						☹	
CNMG120404-NF4	0,4	0,05 - 0,12	0,2 - 1,0						☹					☹	☹	☹							☹	☹		
	0,8	0,07 - 0,16	0,4 - 1,5						☹					☹	☹	☹							☹	☹		
	1,2	0,10 - 0,20	0,5 - 1,6											☹	☹								☹	☹		
CNMG090304-FP5	0,4	0,04 - 0,20	0,1 - 1,5	☹	☹																					
	0,8	0,08 - 0,25	0,2 - 2,0	☹	☹																					
	0,4	0,04 - 0,20	0,1 - 1,5	☹	☹																					
	0,8	0,08 - 0,25	0,2 - 2,0	☹	☹																					
	1,2	0,10 - 0,25	0,5 - 2,5	☹	☹																					
CNMG120408-NM	0,8	0,20 - 0,55	0,8 - 3,0						☺	☺	☹			☹				☺	☹				☹			
	1,2	0,25 - 0,70	1,5 - 4,0						☺	☺	☹			☹				☺	☹				☹			
CNMG120408-NMT	0,8	0,12 - 0,30	0,8 - 4,0											☹									☹	☹		
	1,2	0,15 - 0,32	1,0 - 4,0											☹									☹	☹		
CNMG120404-NMS	0,4	0,10 - 0,24	0,6 - 2,5											☹	☹	☹						☹	☹	☹		
	0,8	0,13 - 0,32	0,8 - 3,5											☹	☹	☹						☹	☹	☹		
	1,2	0,16 - 0,36	1,0 - 3,5											☹	☹	☹						☹	☹	☹		

For dimensions, see the ISO 1832 designation key from page A-4 onwards.
For achievable surface finish qualities and technical information, see page A 298 in the Walter General catalogue 2012.

HC = Coated carbide
HW = Uncoated carbide

WALTER SELECT

Best insert for:

☺
good

☹
moderate

☹
unfavourable

machining conditions

☹☹☹ New addition to range



Negative basic shape CNGG/CNMG/CNMA/CNMM

Tiger-tec® Silver

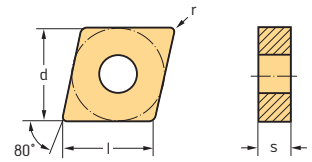

Indexable inserts

Designation	r mm	f mm	ap mm	P							M			K				S							
				WPP10S	WPP20S	WPP30S	WMP20S	WPP01	WPP05	WPP10	WPP20	WPP30	WMP20S	WSM10	WSM20	WSM30	WKK10S	WKK20S	WAK10	WAK20	WAK30	WSM10	WSM20	WSM30	WS10
	CNMG090304-MP3	0,4	0,06 - 0,20	0,3 - 2,2	☺	☺																			
	CNMG090308-MP3	0,8	0,10 - 0,28	0,6 - 3,0	☺	☺																			
	CNMG120404-MP3	0,4	0,08 - 0,22	0,3 - 2,5	☺	☺	☹																		
	CNMG120408-MP3	0,8	0,12 - 0,32	0,6 - 3,2	☺	☺	☹																		
	CNMG120412-MP3	1,2	0,16 - 0,40	0,8 - 3,5	☺	☺	☹																		
	CNMG120404-NM4	0,4	0,10 - 0,18	0,5 - 2,0				☹	☺	☺	☹	☹	☹	☹	☹							☺	☺	☹	
	CNMG120408-NM4	0,8	0,15 - 0,25	0,8 - 3,0				☹	☺	☺	☹	☹	☹	☹	☹							☺	☺	☹	
	CNMG120412-NM4	1,2	0,18 - 0,30	0,8 - 3,5				☹	☺	☺	☹	☹	☹	☹	☹							☺	☺	☹	
	CNMG120416-NM4	1,6	0,25 - 0,40	1,2 - 5,0						☺	☹	☹	☹	☹									☺	☹	
	CNMG160608-NM4	0,8	0,25 - 0,50	0,8 - 7,0				☹	☺	☺	☹	☹	☹	☹	☹							☺	☺	☹	
	CNMG160612-NM4	1,2	0,18 - 0,35	0,8 - 4,5				☹	☺	☺	☹	☹	☹	☹	☹							☺	☺	☹	
CNMG160616-NM4	1,6	0,35 - 0,55	1,2 - 7,0						☺	☹	☹	☹	☹									☺	☹		
	CNMG120404-MP5	0,4	0,16 - 0,25	0,5 - 4,0	☹	☹	☹																		
	CNMG120408-MP5	0,8	0,18 - 0,40	0,6 - 5,0	☹	☹	☹																		
	CNMG120412-MP5	1,2	0,20 - 0,45	1,0 - 5,0	☹	☹	☹																		
	CNMG120416-MP5	1,6	0,25 - 0,50	1,2 - 5,0	☹	☹	☹																		
	CNMG160608-MP5	0,8	0,25 - 0,50	0,8 - 7,0	☹	☹	☹																		
	CNMG160612-MP5	1,2	0,30 - 0,50	1,0 - 7,0	☹	☹	☹																		
	CNMG090308-MK5	0,8	0,10 - 0,20	0,2 - 3,0												☹	☹								
	CNMG120404-MK5	0,4	0,16 - 0,25	0,6 - 5,0												☹	☹								
	CNMG120408-MK5	0,8	0,25 - 0,50	0,8 - 5,0												☹	☹								
	CNMG120412-MK5	1,2	0,30 - 0,50	1,2 - 5,0												☹	☹								
	CNMG120416-MK5	1,6	0,35 - 0,50	1,5 - 5,0												☹	☹								
	CNMG160608-MK5	0,8	0,25 - 0,50	0,8 - 7,0												☹	☹								
	CNMG160612-MK5	1,2	0,30 - 0,60	1,2 - 7,0												☹	☹								
	CNMG160616-MK5	1,6	0,35 - 0,60	1,5 - 7,0												☹	☹								
	CNMG190612-MK5	1,2	0,30 - 0,65	1,2 - 8,0												☹	☹								
	CNMG190616-MK5	1,6	0,35 - 0,80	1,5 - 8,0												☹	☹								

For dimensions, see the ISO 1832 designation key from page A-4 onwards.
For achievable surface finish qualities and technical information, see page A 298 in the Walter General catalogue 2012.

HC = Coated carbide
HW = Uncoated carbide



☹ ☹ ☹ New addition to range

Negative basic shape CNGG/CNMG/CNMA/CNMM

Tiger-tec® Silver

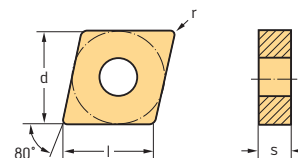

Indexable inserts

Designation	r mm	f mm	ap mm	P HC							M HC			K HC				S HC		HW						
				WPP10S	WPP20S	WPP30S	WMP20S	WPP01	WPP05	WPP10	WPP20	WPP30	WMP20S	WSM10	WSM20	WSM30	WKK10S	WKK20S	WAK10	WAK20	WAK30	WSM10	WSM20	WSM30	WS10	
CNMG120404-NM5	0,4	0,16 - 0,25	0,6 - 5,0																							
CNMG120408-NM5	0,8	0,25 - 0,50	0,8 - 5,0																							
CNMG120412-NM5	1,2	0,30 - 0,50	1,2 - 5,0																							
CNMG120416-NM5	1,6	0,35 - 0,50	1,5 - 5,0																							
CNMG160608-NM5	0,8	0,25 - 0,50	0,8 - 7,0																							
CNMG160612-NM5	1,2	0,30 - 0,60	1,2 - 7,0																							
CNMG160616-NM5	1,6	0,35 - 0,60	1,5 - 7,0																							
CNMG190612-NM5	1,2	0,30 - 0,65	1,2 - 8,0																							
CNMG190616-NM5	1,6	0,35 - 0,80	1,5 - 8,0																							
CNMG190624-NM5	2,4	0,40 - 0,90	2,5 - 8,0																							
CNMG120408-NM6	0,8	0,25 - 0,50	0,8 - 5,0																							
CNMG120412-NM6	1,2	0,30 - 0,50	1,2 - 5,0																							
CNMG120416-NM6	1,6	0,35 - 0,50	1,5 - 5,0																							
CNMG160608-NM6	0,8	0,30 - 0,50	0,8 - 6,0																							
CNMG160612-NM6	1,2	0,35 - 0,60	1,2 - 6,0																							
CNMG160616-NM6	1,6	0,40 - 0,60	1,5 - 6,0																							
CNMG190612-NM6	1,2	0,35 - 0,60	1,2 - 7,0																							
CNMG190616-NM6	1,6	0,40 - 0,60	1,5 - 7,0																							
CNMG190624-NM6	2,4	0,40 - 0,60	2,5 - 7,0																							
CNMG250924-NM6	2,4	0,45 - 1,00	3,0 - 9,0																							
CNMG120408-NM9	0,8	0,20 - 0,40	1,0 - 6,0																							
CNMG120412-NM9	1,2	0,25 - 0,55	1,0 - 6,0																							
CNMG120416-NM9	1,6	0,35 - 0,65	1,0 - 6,0																							
CNMG160608-NM9	0,8	0,20 - 0,45	2,0 - 8,0																							
CNMG160612-NM9	1,2	0,25 - 0,60	2,0 - 8,0																							
CNMG160616-NM9	1,6	0,35 - 0,70	2,0 - 8,0																							
CNMG190608-NM9	0,8	0,20 - 0,50	2,0 - 10,0																							
CNMG190612-NM9	1,2	0,30 - 0,65	2,0 - 10,0																							
CNMG190616-NM9	1,6	0,35 - 0,80	2,0 - 10,0																							

For dimensions, see the ISO 1832 designation key from page A-4 onwards.

For achievable surface finish qualities and technical information, see page A 298 in the Walter General catalogue 2012.

HC = Coated carbide

HW = Uncoated carbide



A-120

New addition to range

Negative basic shape CNGG/CNMG/CNMA/CNMM

Tiger-tec® Silver

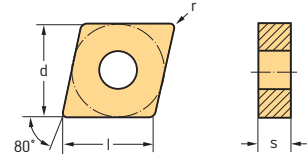

Indexable inserts

Designation	r mm	f mm	ap mm	P									M			K				S				
				HC									HC			HC				HC	HW			
				WPP10S	WPP20S	WPP30S	WMP20S	WPP01	WPP05	WPP10	WPP20	WPP30	WMP20S	WSM10	WSM20	WSM30	WKK10S	WKK20S	WAK10	WAK20	WAK30	WSM10	WSM20	WSM30
	CNMG120408-NRT	0,8	0,18 - 0,35	1,0 - 6,0										☉							☉	☉		
	CNMG120412-NRT	1,2	0,20 - 0,40	1,2 - 6,0										☉								☉	☉	
	CNMG160612-NRT	1,2	0,28 - 0,55	1,5 - 7,5										☉								☉	☉	
	CNMG190616-NRT	1,6	0,35 - 0,70	2,0 - 9,0										☉								☉	☉	
	CNMG120408-NRS	0,8	0,16 - 0,35	1,0 - 4,0										☉	☉						☉	☉		
	CNMG120412-NRS	1,2	0,18 - 0,40	1,2 - 4,0										☉	☉							☉	☉	
	CNMG160612-NRS	1,2	0,21 - 0,45	1,2 - 6,5										☉	☉							☉	☉	
	CNMG160616-NRS	1,6	0,23 - 0,50	1,5 - 6,5										☉	☉							☉	☉	
	CNMG190608-NRS	0,8	0,20 - 0,45	1,0 - 8,0										☉	☉							☉	☉	
	CNMG190612-NRS	1,2	0,23 - 0,50	1,2 - 8,5										☉	☉							☉	☉	
	CNMG120408-NR4	0,8	0,22 - 0,40	1,2 - 5,0										☉	☉	☉					☉	☉	☉	
	CNMG120412-NR4	1,2	0,25 - 0,50	1,5 - 5,0										☉	☉	☉						☉	☉	☉
	CNMG120416-NR4	1,6	0,30 - 0,55	2,0 - 5,0											☉	☉						☉	☉	☉
	CNMG160608-NR4	0,8	0,22 - 0,45	1,2 - 7,0											☉	☉	☉					☉	☉	☉
	CNMG160612-NR4	1,2	0,25 - 0,60	1,5 - 7,0										☉	☉	☉						☉	☉	☉
	CNMG160616-NR4	1,6	0,30 - 0,65	2,0 - 7,0											☉	☉						☉	☉	☉
	CNMG190612-NR4	1,2	0,25 - 0,60	1,5 - 8,0										☉	☉	☉						☉	☉	☉
	CNMG190616-NR4	1,6	0,30 - 0,80	2,0 - 8,0											☉	☉						☉	☉	☉
	CNMG120408-RP5	0,8	0,20 - 0,40	0,8 - 6,0	☉	☉	☉																	
	CNMG120412-RP5	1,2	0,06 - 0,25	1,0 - 6,0	☉	☉	☉																	
	CNMG120416-RP5	1,6	0,07 - 0,35	1,6 - 6,0	☉	☉	☉																	
	CNMG160608-RP5	0,8	0,20 - 0,45	1,0 - 8,0	☉	☉	☉																	
	CNMG160612-RP5	1,2	0,25 - 0,60	1,2 - 8,0	☉	☉	☉																	
	CNMG160616-RP5	1,6	0,35 - 0,70	1,6 - 8,0	☉	☉	☉																	
	CNMG160624-RP5	2,4	0,40 - 0,90	2,0 - 8,0	☉	☉																		
	CNMG190608-RP5	0,8	0,20 - 0,50	1,0 - 10,0	☉	☉	☉																	
	CNMG190612-RP5	1,2	0,25 - 0,65	1,2 - 10,0	☉	☉	☉																	
	CNMG190616-RP5	1,6	0,35 - 0,80	1,6 - 10,0	☉	☉	☉																	
	CNMG190624-RP5	2,4	0,45 - 1,00	2,0 - 10,0	☉	☉	☉																	

For dimensions, see the ISO 1832 designation key from page A-4 onwards.
For achievable surface finish qualities and technical information,
see page A 298 in the Walter General catalogue 2012.

HC = Coated carbide
HW = Uncoated carbide



New addition to range

Negative basic shape CNGG/CNMG/CNMA/CNMM

Tiger-tec® Silver

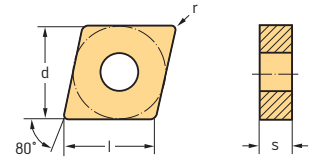

Indexable inserts

Designation	r mm	f mm	ap mm	P							M			K				S								
				HC							HC			HC				HC	HW							
				WPP10S	WPP20S	WPP30S	WMP20S	WPP01	WPP05	WPP10	WPP20	WPP30	WMP20S	WSM10	WSM20	WSM30	WKK10S	WKK20S	WAK10	WAK20	WAK30	WSM10	WSM20	WSM30	WS10	
CNMA120404-RK5	0,4	0,16 - 0,25	0,6 - 5,0																							
CNMA120408-RK5	0,8	0,25 - 0,50	0,8 - 5,0																							
CNMA120412-RK5	1,2	0,30 - 0,50	1,2 - 5,0																							
CNMA120416-RK5	1,6	0,35 - 0,70	1,5 - 5,0																							
CNMA160612-RK5	1,2	0,35 - 0,70	1,2 - 7,0																							
CNMA160616-RK5	1,6	0,35 - 0,80	1,5 - 7,0																							
CNMA190612-RK5	1,2	0,30 - 0,65	1,2 - 8,0																							
CNMA190616-RK5	1,6	0,35 - 0,80	1,5 - 8,0																							
CNMA190624-RK5	2,4	0,40 - 0,90	2,5 - 8,0																							
CNMA120408-RK7	0,8	0,25 - 0,50	0,8 - 5,0																							
CNMA120412-RK7	1,2	0,30 - 0,50	1,2 - 5,0																							
CNMA120416-RK7	1,6	0,35 - 0,70	1,5 - 5,0																							
CNMA160612-RK7	1,2	0,35 - 0,70	1,2 - 7,0																							
CNMA160616-RK7	1,6	0,35 - 0,80	1,5 - 7,0																							
CNMA190612-RK7	1,2	0,30 - 0,65	1,2 - 8,0																							
CNMA190616-RK7	1,6	0,35 - 0,80	1,5 - 8,0																							
CNMA120404	0,4	0,16 - 0,25	0,6 - 5,0																							
CNMA120408	0,8	0,25 - 0,50	0,8 - 5,0																							
CNMA120412	1,2	0,30 - 0,60	1,2 - 5,0																							
CNMA120416	1,6	0,35 - 0,70	1,5 - 5,0																							
CNMA160612	1,2	0,30 - 0,65	1,2 - 7,0																							
CNMA160616	1,6	0,35 - 0,80	1,5 - 7,0																							
CNMA190612	1,2	0,30 - 0,65	1,2 - 8,0																							
CNMA190616	1,6	0,35 - 0,80	1,5 - 8,0																							
CNMA190624	2,4	0,40 - 0,90	2,5 - 8,0																							

For dimensions, see the ISO 1832 designation key from page A-4 onwards.
For achievable surface finish qualities and technical information, see page A 298 in the Walter General catalogue 2012.

HC = Coated carbide
HW = Uncoated carbide

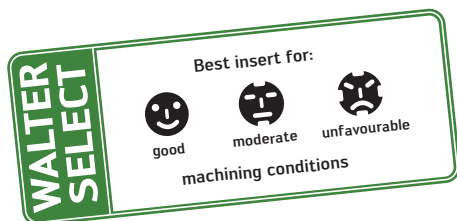

New addition to range

Negative basic shape CNGG/CNMG/CNMA/CNMM

Tiger-tec® Silver

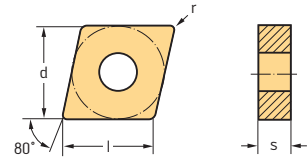

Indexable inserts

Designation	r mm	f mm	ap mm	P									M			K				S					
				HC									HC			HC				HC			HW		
				WPP10S	WPP20S	WPP30S	WMP20S	WPP01	WPP05	WPP10	WPP20	WPP30	WMP20S	WSM10	WSM20	WSM30	WKK10S	WKK20S	WAK10	WAK20	WAK30	WSM10	WSM20	WSM30	WS10
CNMA120408T02020	0,8	0,25 - 0,50	0,8 - 5,0															☺	☺						
CNMA120412T02020	1,2	0,30 - 0,60	1,2 - 5,0															☺	☺						
CNMA120416T02020	1,6	0,35 - 0,70	1,5 - 5,0															☺	☺						
CNMA160612T02020	1,2	0,30 - 0,65	1,2 - 7,0															☺	☺						
CNMA160616T02020	1,6	0,35 - 0,80	1,5 - 7,0															☺	☺						
CNMA190612T02020	1,2	0,30 - 0,65	1,2 - 8,0															☺	☺						
CNMA190616T02020	1,6	0,35 - 0,80	1,5 - 8,0															☺	☺						
CNMM120408-NRF	0,8	0,30 - 0,50	0,8 - 7,0	☺	☺	☺			☺																
CNMM120412-NRF	1,2	0,35 - 0,70	1,2 - 7,0	☺	☺	☺			☺																
CNMM120416-NRF	1,6	0,40 - 0,80	1,6 - 7,0	☺	☺	☺			☺																
CNMM160612-NRF	1,2	0,35 - 0,70	1,2 - 9,0	☺	☺	☺			☺																
CNMM160616-NRF	1,6	0,40 - 0,90	1,6 - 9,0	☺	☺	☺			☺																
CNMM160624-NRF	2,4	0,45 - 1,00	2,4 - 9,0	☺	☺	☺			☺																
CNMM190612-NRF	1,2	0,35 - 0,70	1,2 - 10,0	☺	☺	☺			☺																
CNMM190616-NRF	1,6	0,40 - 0,90	1,6 - 10,0	☺	☺	☺			☺																
CNMM190624-NRF	2,4	0,45 - 1,10	2,4 - 10,0	☺	☺	☺			☺																
CNMM250924-NRF	2,4	0,45 - 1,20	2,4 - 12,0		☺	☺																			
CNMM190612-NR6	1,2	0,40 - 0,70	2,0 - 10,0									☺													
CNMM190616-NR6	1,6	0,45 - 0,90	2,0 - 10,0							☺	☺	☺													
CNMM190624-NR6	2,4	0,55 - 1,20	2,5 - 10,0								☺														
CNMM120412-NRR	1,2	0,40 - 0,80	1,5 - 8,0	☺	☺	☺																			
CNMM160612-NRR	1,2	0,50 - 0,90	2,0 - 10,0	☺	☺	☺																☺			
CNMM160616-NRR	1,6	0,50 - 1,10	2,0 - 10,0	☺	☺	☺																☺			
CNMM160624-NRR	2,4	0,50 - 1,30	2,0 - 10,0	☺	☺	☺																			
CNMM190612-NRR	1,2	0,50 - 0,90	2,0 - 13,0	☺	☺	☺																☺			
CNMM190616-NRR	1,6	0,50 - 1,10	2,0 - 13,0	☺	☺	☺																☺			
CNMM190624-NRR	2,4	0,60 - 1,60	3,0 - 13,0	☺	☺	☺																☺			
CNMM250924-NRR	2,4	0,60 - 1,60	3,0 - 17,0	☺	☺	☺																☺			

For dimensions, see the ISO 1832 designation key from page A-4 onwards.
For achievable surface finish qualities and technical information,
see page A 298 in the Walter General catalogue 2012.

HC = Coated carbide
HW = Uncoated carbide



☺ ☺ ☺ New addition to range

Negative basic shape DNGG/DNMG/DNMA/DNMM

Tiger-tec® Silver

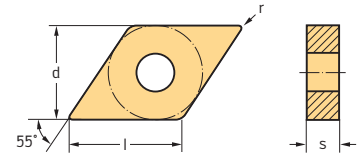

Indexable inserts

Designation	r mm	f mm	ap mm	P							M			K			S								
				WPP10S	WPP20S	WPP30S	WMP20S	WPP01	WPP05	WPP10	WPP20	WPP30	WMP20S	WSM10	WSM20	WSM30	WKK10S	WKK20S	WAK10	WAK20	WSM10	WSM20	WSM30	WS10	HW
Wiper	DNMG110408-NF	0,8	0,15 - 0,50	0,5 - 2,0																					
	DNMG150408-NF	0,8	0,15 - 0,50	0,5 - 3,0																					
	DNMG150608-NF	0,8	0,15 - 0,50	0,5 - 3,0																					
	DNMG150404-NFT	0,4	0,06 - 0,16	0,4 - 1,5																					
	DNMG150408-NFT	0,8	0,08 - 0,19	0,5 - 2,0																					
	DNMG150604-NFT	0,4	0,06 - 0,16	0,4 - 1,5																					
	DNMG150608-NFT	0,8	0,08 - 0,19	0,5 - 2,0																					
	DNGG150404-NFT	0,4	0,05 - 0,14	0,2 - 1,5																					
	DNGG150408-NFT	0,8	0,07 - 0,17	0,3 - 2,0																					
	DNGG150604-NFT	0,4	0,05 - 0,14	0,2 - 1,5																					
	DNGG150608-NFT	0,8	0,07 - 0,17	0,3 - 2,0																					
		DNMG110404-NF4	0,4	0,05 - 0,12	0,2 - 1,0																				
DNMG110408-NF4		0,8	0,07 - 0,16	0,4 - 1,5																					
DNMG150404-NF4		0,4	0,05 - 0,12	0,2 - 1,0																					
DNMG150408-NF4		0,8	0,07 - 0,16	0,4 - 1,5																					
DNMG150412-NF4		1,2	0,10 - 0,20	0,5 - 1,6																					
DNMG150604-NF4		0,4	0,05 - 0,12	0,2 - 1,0																					
DNMG150608-NF4		0,8	0,07 - 0,16	0,4 - 1,5																					
DNMG150612-NF4		1,2	0,10 - 0,20	0,5 - 1,6																					
	DNMG110402-FP5	0,2	0,04 - 0,12	0,1 - 0,5																					
	DNMG110404-FP5	0,4	0,04 - 0,20	0,1 - 1,5																					
	DNMG110408-FP5	0,8	0,08 - 0,25	0,2 - 2,0																					
	DNMG110412-FP5	1,2	0,10 - 0,25	0,5 - 2,5																					
	DNMG150404-FP5	0,4	0,05 - 0,20	0,1 - 1,5																					
	DNMG150408-FP5	0,8	0,08 - 0,25	0,2 - 2,0																					
	DNMG150412-FP5	1,2	0,10 - 0,25	0,5 - 2,5																					
	DNMG150604-FP5	0,4	0,05 - 0,20	0,1 - 1,5																					
	DNMG150608-FP5	0,8	0,08 - 0,25	0,2 - 2,0																					
	DNMG150612-FP5	1,2	0,10 - 0,25	0,5 - 2,5																					

For dimensions, see the ISO 1832 designation key from page A-4 onwards.
For achievable surface finish qualities and technical information, see page A 298 in the Walter General catalogue 2012.

HC = Coated carbide
HW = Uncoated carbide



New addition to range

Negative basic shape DNGG/DNMG/DNMA/DNMM

Tiger-tec® Silver

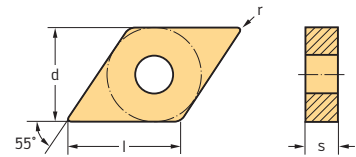

Indexable inserts

Designation	r mm	f mm	ap mm	P							M			K				S		HW					
				HC							HC			HC				HC							
				WPP10S	WPP20S	WPP30S	WMP20S	WPP01	WPP05	WPP10	WPP20	WPP30	WMP20S	WSM10	WSM20	WSM30	WKK10S	WKK20S	WAK10	WAK20	WSM10	WSM20	WSM30	WS10	
Wiper	DNMG110408-NM	0,8	0,15 - 0,50	0,8 - 3,0					☺	☺	☹							☺	☹						
	DNMG110412-NM	1,2	0,20 - 0,60	1,5 - 4,0					☺	☺	☹							☺	☹						
	DNMG150408-NM	0,8	0,15 - 0,50	0,8 - 3,0					☺	☺	☹								☺	☹					
	DNMG150412-NM	1,2	0,20 - 0,60	1,5 - 4,0					☺	☺	☹								☺	☹					
	DNMG150608-NM	0,8	0,15 - 0,50	0,8 - 3,0					☺	☺	☹								☺	☹					
	DNMG150612-NM	1,2	0,20 - 0,60	1,5 - 4,0					☺	☺	☹								☺	☹					
	DNMG110404-NMT	0,4	0,08 - 0,22	0,4 - 2,5											☹							☹	☹	☹	
	DNMG110408-NMT	0,8	0,12 - 0,28	0,6 - 3,2											☹	☹						☹	☹	☹	
	DNMG150408-NMT	0,8	0,12 - 0,28	0,6 - 4,0												☹						☹	☹	☹	
	DNMG150412-NMT	1,2	0,15 - 0,30	0,8 - 4,0												☹						☹	☹	☹	
	DNMG150608-NMT	0,8	0,12 - 0,28	0,6 - 4,0												☹	☹					☹	☹	☹	
	DNMG150612-NMT	1,2	0,15 - 0,30	0,8 - 4,0													☹					☹	☹	☹	
	DNMG150404-NMS	0,4	0,09 - 0,22	0,6 - 2,5											☹	☹					☹	☹			
	DNMG150408-NMS	0,8	0,11 - 0,30	0,8 - 3,5											☹	☹	☹				☹	☹	☹		
	DNMG150604-NMS	0,4	0,09 - 0,22	0,6 - 2,5											☹	☹					☹	☹			
	DNMG150608-NMS	0,8	0,11 - 0,30	0,8 - 3,5											☹	☹	☹				☹	☹	☹		
	DNMG110404-MP3	0,4	0,08 - 0,22	0,3 - 2,2	☹	☹	☹																		
	DNMG110408-MP3	0,8	0,12 - 0,32	0,6 - 3,0	☹	☹	☹																		
	DNMG110412-MP3	1,2	0,16 - 0,40	0,8 - 3,2	☹	☹	☹																		
	DNMG150404-MP3	0,4	0,08 - 0,22	0,3 - 2,5	☹	☹	☹																		
	DNMG150408-MP3	0,8	0,12 - 0,32	0,6 - 3,2	☹	☹	☹																		
	DNMG150412-MP3	1,2	0,16 - 0,40	0,8 - 3,5	☹	☹	☹																		
	DNMG150604-MP3	0,4	0,08 - 0,22	0,3 - 2,5	☹	☹	☹																		
	DNMG150608-MP3	0,8	0,12 - 0,32	0,6 - 3,2	☹	☹	☹																		
	DNMG150612-MP3	1,2	0,16 - 0,40	0,8 - 3,5	☹	☹	☹																		

For dimensions, see the ISO 1832 designation key from page A-4 onwards.
For achievable surface finish qualities and technical information, see page A 298 in the Walter General catalogue 2012.

HC = Coated carbide
HW = Uncoated carbide

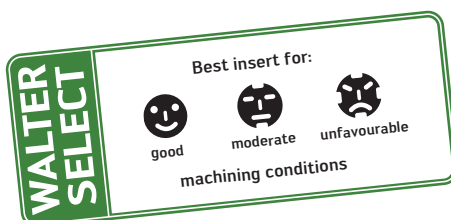



☹ ☹ ☹ New addition to range

Negative basic shape DNMG/DNMG/DNMA/DNMM

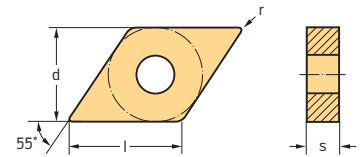
Tiger-tec® Silver



Indexable inserts

Designation	r mm	f mm	ap mm	P										M			K				S			HW
				HC										HC			HC				HC			
				WPP10S	WPP20S	WPP30S	WMP20S	WPP01	WPP05	WPP10	WPP20	WPP30	WMP20S	WSM10	WSM20	WSM30	WKK10S	WKK20S	WAK10	WAK20	WSM10	WSM20	WSM30	
 DNMG110404-NM4	0,4	0,10 - 0,18	0,5 - 2,0				☺	☺	☺	☺	☺	☺	☺	☺							☺	☺	☺	
DNMG110408-NM4	0,8	0,15 - 0,25	0,8 - 3,0				☺	☺	☺	☺	☺	☺	☺	☺							☺	☺	☺	
DNMG110412-NM4	1,2	0,20 - 0,35	1,0 - 4,0					☺	☺	☺			☺	☺							☺	☺	☺	
DNMG150404-NM4	0,4	0,10 - 0,18	0,5 - 2,5				☺		☺	☺	☺	☺	☺	☺							☺	☺	☺	
DNMG150408-NM4	0,8	0,15 - 0,25	0,8 - 3,5				☺		☺	☺	☺	☺	☺	☺							☺	☺	☺	
DNMG150412-NM4	1,2	0,20 - 0,40	1,0 - 5,0					☺	☺	☺			☺	☺							☺	☺	☺	
DNMG150604-NM4	0,4	0,10 - 0,18	0,5 - 2,5				☺		☺	☺	☺	☺	☺	☺							☺	☺	☺	
DNMG150608-NM4	0,8	0,15 - 0,25	0,8 - 3,5				☺		☺	☺	☺	☺	☺	☺							☺	☺	☺	
DNMG150612-NM4	1,2	0,18 - 0,30	0,8 - 4,0				☺		☺	☺	☺	☺	☺	☺							☺	☺	☺	
DNMG150616-NM4	1,6	0,25 - 0,40	1,2 - 5,0					☺	☺												☺	☺	☺	
 DNMG110404-MP5	0,4	0,16 - 0,25	0,5 - 4,0	☺	☺	☺																		
DNMG110408-MP5	0,8	0,18 - 0,35	0,6 - 4,0	☺	☺	☺																		
DNMG110412-MP5	1,2	0,20 - 0,40	1,0 - 4,0	☺	☺	☺																		
DNMG150404-MP5	0,4	0,16 - 0,25	0,5 - 4,0	☺	☺	☺																		
DNMG150408-MP5	0,8	0,18 - 0,35	0,6 - 5,0	☺	☺	☺																		
DNMG150412-MP5	1,2	0,20 - 0,40	1,0 - 5,0	☺	☺	☺																		
DNMG150416-MP5	1,6	0,25 - 0,45	1,2 - 5,0	☺	☺	☺																		
DNMG150604-MP5	0,4	0,16 - 0,25	0,5 - 4,0	☺	☺	☺																		
DNMG150608-MP5	0,8	0,18 - 0,35	0,6 - 5,0	☺	☺	☺																		
DNMG150612-MP5	1,2	0,20 - 0,40	1,0 - 5,0	☺	☺	☺																		
DNMG150616-MP5	1,6	0,25 - 0,45	1,2 - 5,0	☺	☺	☺																		
 DNMG110404-MK5	0,4	0,15 - 0,25	0,6 - 4,0												☺	☺								
DNMG110408-MK5	0,8	0,15 - 0,40	0,6 - 4,0												☺	☺								
DNMG110412-MK5	1,2	0,20 - 0,50	1,0 - 4,0												☺	☺								
DNMG150408-MK5	0,8	0,20 - 0,45	0,8 - 5,0												☺	☺								
DNMG150412-MK5	1,2	0,25 - 0,45	1,2 - 5,0												☺	☺								
DNMG150608-MK5	0,8	0,25 - 0,45	0,8 - 5,0												☺	☺								
DNMG150612-MK5	1,2	0,30 - 0,45	1,2 - 5,0												☺	☺								
DNMG150616-MK5	1,6	0,35 - 0,45	1,6 - 5,0												☺	☺								

For dimensions, see the ISO 1832 designation key from page A-4 onwards.
For achievable surface finish qualities and technical information, see page A 298 in the Walter General catalogue 2012.

HC = Coated carbide
HW = Uncoated carbide



☺ ☺ ☺ New addition to range

Negative basic shape DNGG/DNMG/DNMA/DNMM

Tiger-tec® Silver

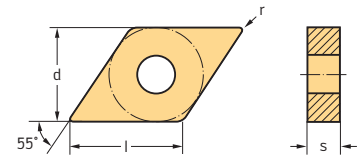

Indexable inserts

Designation	r mm	f mm	ap mm	P							M			K			S							
				HC							HC			HC			HC	HW						
				WPP10S	WPP20S	WPP30S	WMP20S	WPP01	WPP05	WPP10	WPP20	WPP30	WMP20S	WSM10	WSM20	WSM30	WKK10S	WKK20S	WAK10	WAK20	WSM10	WSM20	WSM30	WS10
DNMG110404-NM5	0,4	0,15 - 0,25	0,6 - 4,0															☺	☺					
DNMG110408-NM5	0,8	0,15 - 0,40	0,6 - 4,0															☺	☺					
DNMG110412-NM5	1,2	0,20 - 0,50	1,0 - 4,0															☺	☺					
DNMG150408-NM5	0,8	0,25 - 0,45	0,8 - 5,0															☺	☺					
DNMG150412-NM5	1,2	0,30 - 0,45	1,2 - 5,0															☺	☺					
DNMG150608-NM5	0,8	0,25 - 0,45	0,8 - 5,0															☺	☺					
DNMG150612-NM5	1,2	0,30 - 0,45	1,2 - 5,0															☺	☺					
DNMG150616-NM5	1,6	0,35 - 0,45	1,6 - 5,0															☺	☺					
DNMG110408-NM9	0,8	0,15 - 0,35	1,0 - 4,0					☺	☺	☺	☺													
DNMG110412-NM9	1,2	0,20 - 0,40	1,0 - 4,0					☺	☺	☺	☺													
DNMG150408-NM9	0,8	0,15 - 0,35	1,0 - 5,0					☺	☺	☺	☺													
DNMG150412-NM9	1,2	0,20 - 0,40	1,0 - 5,0					☺	☺	☺	☺													
DNMG150608-NM9	0,8	0,15 - 0,35	1,0 - 5,0					☺	☺	☺														
DNMG150612-NM9	1,2	0,20 - 0,40	1,0 - 5,0					☺	☺	☺	☺													
DNMG150616-NM9	1,6	0,25 - 0,50	1,0 - 6,0					☺	☺	☺	☺													
DNMG150408-NRS	0,8	0,13 - 0,32	1,0 - 4,0										☺	☺							☺	☺		
DNMG150412-NRS	1,2	0,15 - 0,35	1,2 - 4,0										☺	☺							☺	☺		
DNMG150608-NRS	0,8	0,13 - 0,32	1,0 - 4,0										☺	☺							☺	☺		
DNMG150612-NRS	1,2	0,15 - 0,35	1,2 - 4,0										☺	☺							☺	☺		
DNMG110408-NR4	0,8	0,22 - 0,40	1,2 - 3,0																			☺	☺	
DNMG110412-NR4	1,2	0,25 - 0,50	1,5 - 3,5																			☺	☺	
DNMG150408-NR4	0,8	0,22 - 0,40	1,2 - 4,0																			☺	☺	
DNMG150412-NR4	1,2	0,25 - 0,50	1,5 - 4,0																			☺	☺	
DNMG150608-NR4	0,8	0,22 - 0,40	1,2 - 4,0										☺	☺	☺						☺	☺	☺	
DNMG150612-NR4	1,2	0,25 - 0,50	1,5 - 4,0										☺	☺	☺						☺	☺	☺	

For dimensions, see the ISO 1832 designation key from page A-4 onwards.
For achievable surface finish qualities and technical information, see page A 298 in the Walter General catalogue 2012.

HC = Coated carbide
HW = Uncoated carbide

Negative basic shape DNGG/DNMG/DNMA/DNMM

Tiger-tec® Silver

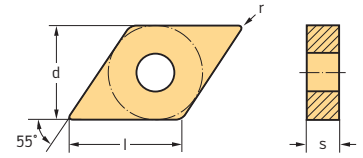

Indexable inserts

Designation	r mm	f mm	ap mm	P							M			K			S						
				WPP10S	WPP20S	WPP30S	WMP20S	WPP01	WPP05	WPP10	WPP20	WPP30	WMP20S	WSM10	WSM20	WSM30	WKK10S	WKK20S	WAK10	WAK20	WSM10	WSM20	WSM30
	DNMG110408-RP5	0,8	0,18 - 0,35	0,8 - 4,0	☺	☺	☺																
	DNMG110412-RP5	1,2	0,20 - 0,40	1,0 - 4,0	☺	☺	☺																
	DNMG150408-RP5	0,8	0,15 - 0,35	0,8 - 5,0	☺	☺	☺																
	DNMG150412-RP5	1,2	0,20 - 0,40	1,0 - 5,0	☺	☺	☺																
	DNMG150416-RP5	1,6	0,25 - 0,50	1,6 - 6,0	☺	☺	☺																
	DNMG150608-RP5	0,8	0,15 - 0,35	0,8 - 5,0	☺	☺	☺								☺								
	DNMG150612-RP5	1,2	0,20 - 0,55	1,0 - 6,0	☺	☺	☺								☺								
	DNMG150616-RP5	1,6	0,25 - 0,65	1,6 - 6,0	☺	☺	☺																
	DNMA110404-RK5	0,4	0,16 - 0,25	0,6 - 4,0											☺	☺							
	DNMA110408-RK5	0,8	0,18 - 0,40	0,6 - 4,0											☺	☺							
	DNMA150408-RK5	0,8	0,15 - 0,50	0,8 - 3,0											☺	☺							
	DNMA150412-RK5	1,2	0,20 - 0,60	1,5 - 4,0											☺	☺							
	DNMA150608-RK5	0,8	0,20 - 0,45	0,8 - 5,0											☺	☺							
	DNMA150612-RK5	1,2	0,25 - 0,45	1,2 - 5,0											☺	☺							
	DNMA150608-RK7	0,8	0,20 - 0,45	0,8 - 5,0										☺	☺								
	DNMA150612-RK7	1,2	0,25 - 0,45	1,2 - 5,0										☺	☺								
	DNMA110404	0,4	0,16 - 0,25	0,6 - 4,0												☺	☺						
	DNMA110408	0,8	0,18 - 0,40	0,6 - 4,0												☺	☺						
	DNMA150408	0,8	0,20 - 0,45	0,8 - 5,0												☺	☺						
	DNMA150412	1,2	0,25 - 0,45	1,2 - 5,0												☺	☺						
	DNMA150608	0,8	0,20 - 0,45	0,8 - 5,0												☺	☺						
	DNMA150612	1,2	0,25 - 0,45	1,2 - 5,0												☺	☺						
	DNMM150608-NRF	0,8	0,25 - 0,45	0,8 - 5,0	☺	☺	☺																
	DNMM150612-NRF	1,2	0,30 - 0,50	1,2 - 5,0	☺	☺	☺		☺														
	DNMM150616-NRF	1,6	0,35 - 0,60	1,6 - 5,0	☺	☺	☺		☺														

For dimensions, see the ISO 1832 designation key from page A-4 onwards.
For achievable surface finish qualities and technical information, see page A 298 in the Walter General catalogue 2012.

HC = Coated carbide
HW = Uncoated carbide

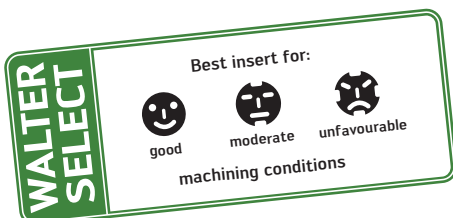

☺ ☺ ☺ New addition to range



Negative basic shape SNMG/SNMA/SNMM

Tiger-tec® Silver

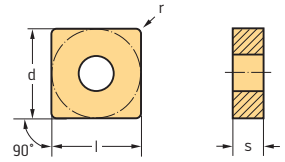

Indexable inserts

Designation	r mm	f mm	ap mm	P								M			K				S					
				HC								HC			HC				HC			HW		
				WPP10S	WPP20S	WPP30S	WMP20S	WPP05	WPP10	WPP20	WPP30	WMP20S	WSM10	WSM20	WSM30	WKK10S	WKK20S	WAK10	WAK20	WAK30	WSM10	WSM20	WSM30	WS10
	SNMG120404-NF4	0,4	0,05 - 0,12	0,2 - 1,0																				
	SNMG120408-NF4	0,8	0,07 - 0,16	0,4 - 1,5																				
	SNMG120412-NF4	1,2	0,10 - 0,20	0,5 - 1,6																				
	SNMG090308-FP5	0,8	0,06 - 0,20	0,2 - 1,5	☺	☹																		
	SNMG120404-FP5	0,4	0,04 - 0,22	0,1 - 1,8	☺	☹																		
	SNMG120408-FP5	0,8	0,08 - 0,25	0,2 - 2,0	☺	☹																		
	SNMG120412-FP5	1,2	0,10 - 0,25	0,5 - 2,5	☺	☹																		
	SNMG090308-MP3	0,8	0,10 - 0,32	0,6 - 3,0	☺	☹																		
	SNMG120404-MP3	0,4	0,08 - 0,25	0,3 - 2,5	☺	☹																		
	SNMG120408-MP3	0,8	0,12 - 0,35	0,6 - 3,2	☺	☹	☹																	
	SNMG120412-MP3	1,2	0,16 - 0,40	0,8 - 3,5	☺	☹																		
	SNMG120404-NM4	0,4	0,10 - 0,18	0,5 - 2,0									☹	☹							☹	☹		
	SNMG120408-NM4	0,8	0,15 - 0,25	0,8 - 3,0				☹	☹	☹	☹	☹	☹	☹	☹						☹	☹	☹	
	SNMG120412-NM4	1,2	0,18 - 0,30	0,8 - 3,5				☹	☹	☹	☹	☹	☹	☹	☹						☹	☹	☹	
	SNMG120416-NM4	1,6	0,25 - 0,40	1,2 - 5,0						☹	☹	☹										☹	☹	
	SNMG150608-NM4	0,8	0,25 - 0,50	0,8 - 8,0						☹	☹	☹												
	SNMG150612-NM4	1,2	0,30 - 0,50	1,0 - 8,0						☹	☹	☹												
	SNMG150616-NM4	1,6	0,35 - 0,55	1,2 - 8,0						☹	☹	☹												
	SNMG120408-MP5	0,8	0,18 - 0,40	0,6 - 5,0	☺	☹	☹																	
	SNMG120412-MP5	1,2	0,20 - 0,45	1,0 - 5,0	☺	☹	☹																	
	SNMG120416-MP5	1,6	0,25 - 0,50	1,2 - 5,0	☺	☹	☹																	
	SNMG150608-MP5	0,8	0,25 - 0,50	0,8 - 8,0	☺	☹	☹																	
	SNMG150612-MP5	1,2	0,30 - 0,50	1,0 - 8,0	☺	☹	☹																	
	SNMG150616-MP5	1,6	0,35 - 0,55	1,2 - 8,0	☺	☹	☹																	

For dimensions, see the ISO 1832 designation key from page A-4 onwards.
For achievable surface finish qualities and technical information,
see page A 298 in the Walter General catalogue 2012.

HC = Coated carbide
HW = Uncoated carbide

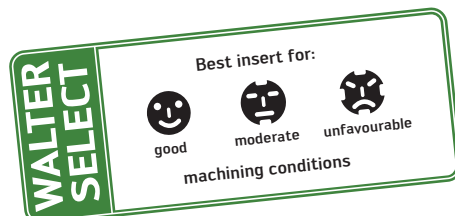



☹ ☹ ☹ New addition to range

Negative basic shape SNMG/SNMA/SNMM

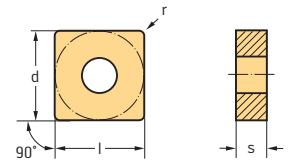
Tiger-tec® Silver



Indexable inserts

Designation	r mm	f mm	ap mm	P HC								M HC			K HC				S HC				HW				
				WPP10S	WPP20S	WPP30S	WMP20S	WPP05	WPP10	WPP20	WPP30	WMP20S	WSM10	WSM20	WSM30	WKK10S	WKK20S	WAK10	WAK20	WAK30	WSM10	WSM20		WSM30	WS10		
 SNMG090308-MK5	0,8	0,10 - 0,20	0,2 - 3,0																								
SNMG120408-MK5	0,8	0,25 - 0,50	0,8 - 5,0																								
SNMG120412-MK5	1,2	0,30 - 0,50	1,2 - 5,0																								
SNMG120416-MK5	1,6	0,35 - 0,50	1,5 - 5,0																								
SNMG150612-MK5	1,2	0,30 - 0,60	1,2 - 7,0																								
SNMG150616-MK5	1,6	0,35 - 0,60	1,5 - 7,0																								
SNMG190612-MK5	1,2	0,30 - 0,65	1,2 - 8,0																								
SNMG190616-MK5	1,6	0,35 - 0,80	1,5 - 8,0																								
 SNMG120408-NM5	0,8	0,25 - 0,50	0,8 - 5,0																								
SNMG120412-NM5	1,2	0,30 - 0,60	1,2 - 5,0																								
SNMG120416-NM5	1,6	0,35 - 0,70	1,5 - 5,0																								
SNMG150608-NM5	0,8	0,25 - 0,50	0,8 - 7,0																								
SNMG150612-NM5	1,2	0,30 - 0,60	1,2 - 7,0																								
SNMG150616-NM5	1,6	0,35 - 0,70	1,5 - 7,0																								
SNMG190612-NM5	1,2	0,30 - 0,65	1,2 - 8,0																								
SNMG190616-NM5	1,6	0,35 - 0,80	1,5 - 8,0																								
SNMG190624-NM5	2,4	0,40 - 0,90	2,5 - 8,0																								
 SNMG120408-NM6	0,8	0,25 - 0,50	0,8 - 5,0																								
SNMG120412-NM6	1,2	0,30 - 0,50	1,2 - 5,0																								
SNMG120416-NM6	1,6	0,35 - 0,50	1,5 - 5,0																								
SNMG150608-NM6	0,8	0,30 - 0,50	0,8 - 6,0																								
SNMG150612-NM6	1,2	0,35 - 0,60	1,2 - 6,0																								
SNMG150616-NM6	1,6	0,40 - 0,60	1,5 - 6,0																								
SNMG190612-NM6	1,2	0,35 - 0,60	1,2 - 7,0																								
SNMG190616-NM6	1,6	0,40 - 0,60	1,5 - 7,0																								
SNMG190624-NM6	2,4	0,40 - 0,60	2,5 - 7,0																								
SNMG250924-NM6	2,4	0,55 - 1,00	3,0 - 10,0																								

For dimensions, see the ISO 1832 designation key from page A-4 onwards.
For achievable surface finish qualities and technical information,
see page A 298 in the Walter General catalogue 2012.



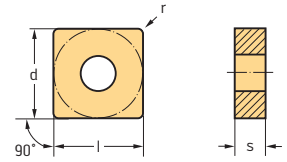

HC = Coated carbide
HW = Uncoated carbide

Negative basic shape SNMG/SNMA/SNMM

Tiger-tec® Silver



Indexable inserts

Designation	r mm	f mm	ap mm	P								M			K				S				
				HC								HC			HC				HC			HW	
				WPP10S	WPP20S	WPP30S	WMP20S	WPP05	WPP10	WPP20	WPP30	WMP20S	WSM10	WSM20	WSM30	WKK10S	WKK20S	WAK10	WAK20	WAK30	WSM10	WSM20	WSM30
 SNMG120408-NM9	0,8	0,20 - 0,50	1,0 - 6,0																				
SNMG120412-NM9	1,2	0,25 - 0,65	1,0 - 6,0																				
SNMG120416-NM9	1,6	0,35 - 0,75	1,0 - 6,0																				
SNMG150612-NM9	1,2	0,25 - 0,70	2,0 - 8,0																				
SNMG150616-NM9	1,6	0,35 - 0,80	2,0 - 8,0																				
SNMG190612-NM9	1,2	0,30 - 0,75	2,0 - 10,0																				
SNMG190616-NM9	1,6	0,35 - 0,90	2,0 - 10,0																				
 SNMG120412-NRT	1,2	0,25 - 0,50	0,8 - 6,0																				
SNMG150612-NRT	1,2	0,30 - 0,60	1,0 - 7,5																				
SNMG150616-NRT	1,6	0,35 - 0,70	1,2 - 7,5																				
SNMG190616-NRT	1,6	0,40 - 0,80	1,5 - 9,0																				
 SNMG120408-NRS	0,8	0,20 - 0,40	0,8 - 5,0																				
SNMG120412-NRS	1,2	0,22 - 0,45	1,0 - 5,0																				
SNMG150616-NRS	1,6	0,24 - 0,55	1,2 - 7,0																				
SNMG190612-NRS	1,2	0,24 - 0,55	1,0 - 9,0																				
SNMG190616-NRS	1,6	0,27 - 0,60	1,2 - 9,0																				
 SNMG120408-NR4	0,8	0,22 - 0,40	1,2 - 5,0																				
SNMG120412-NR4	1,2	0,25 - 0,50	1,5 - 5,0																				
SNMG120416-NR4	1,6	0,30 - 0,55	2,0 - 5,0																				
SNMG150608-NR4	0,8	0,22 - 0,45	1,2 - 7,0																				
SNMG150612-NR4	1,2	0,25 - 0,60	1,5 - 7,0																				
SNMG150616-NR4	1,6	0,30 - 0,65	2,0 - 7,0																				
SNMG190612-NR4	1,2	0,25 - 0,60	1,5 - 8,0																				
SNMG190616-NR4	1,6	0,30 - 0,80	2,0 - 8,0																				

For dimensions, see the ISO 1832 designation key from page A-4 onwards.
For achievable surface finish qualities and technical information,
see page A 298 in the Walter General catalogue 2012.

HC = Coated carbide
HW = Uncoated carbide

Negative basic shape SNMG/SNMA/SNMM

Tiger-tec® Silver

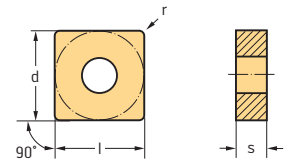

Indexable inserts

Designation	r mm	f mm	ap mm	P								M			K				S						
				HC								HC			HC				HC			HW			
				WPP10S	WPP20S	WPP30S	WMP20S	WPP05	WPP10	WPP20	WPP30	WMP20S	WSM10	WSM20	WSM30	WKK10S	WKK20S	WAK10	WAK20	WAK30	WSM10	WSM20	WSM30	WS10	
SNMG120408-RP5	0,8	0,20 - 0,50	0,8 - 6,0	+	+	+																			
SNMG120412-RP5	1,2	0,25 - 0,65	1,0 - 6,0	+	+	+																			
SNMG120416-RP5	1,6	0,35 - 0,75	1,6 - 6,0	+	+	+																			
SNMG150612-RP5	1,2	0,25 - 0,70	1,2 - 8,0	+	+	+																			
SNMG150616-RP5	1,6	0,35 - 0,80	1,6 - 8,0	+	+	+																			
SNMG190612-RP5	1,2	0,30 - 0,70	1,2 - 10,0	+	+	+																			
SNMG190616-RP5	1,6	0,35 - 0,80	1,6 - 10,0	+	+	+																			
SNMG190624-RP5	2,4	0,44 - 1,20	2,0 - 10,0	+	+	+																			
SNMA090308-RK5	0,8	0,20 - 0,45	0,6 - 4,0														+	+							
SNMA120408-RK5	0,8	0,25 - 0,50	0,8 - 5,0														+	+							
SNMA120412-RK5	1,2	0,30 - 0,60	1,2 - 5,0														+	+							
SNMA120416-RK5	1,6	0,35 - 0,70	1,5 - 5,0														+	+							
SNMA150612-RK5	1,2	0,30 - 0,65	1,2 - 7,0														+	+							
SNMA150616-RK5	1,6	0,35 - 0,80	1,5 - 7,0														+	+							
SNMA190612-RK5	1,2	0,30 - 0,65	1,2 - 8,0														+	+							
SNMA190616-RK5	1,6	0,35 - 0,80	1,5 - 8,0														+	+							
SNMA190624-RK5	2,4	0,40 - 0,90	2,5 - 8,0														+	+							
SNMA120408-RK7	0,8	0,25 - 0,50	0,8 - 5,0														+	+							
SNMA120412-RK7	1,2	0,30 - 0,60	1,2 - 5,0														+	+							
SNMA120416-RK7	1,6	0,35 - 0,70	1,5 - 5,0														+	+							
SNMA150616-RK7	1,6	0,35 - 0,80	1,5 - 7,0														+	+							
SNMA190616-RK7	1,6	0,35 - 0,80	1,5 - 8,0														+	+							

For dimensions, see the ISO 1832 designation key from page A-4 onwards.
For achievable surface finish qualities and technical information, see page A 298 in the Walter General catalogue 2012.

HC = Coated carbide
HW = Uncoated carbide

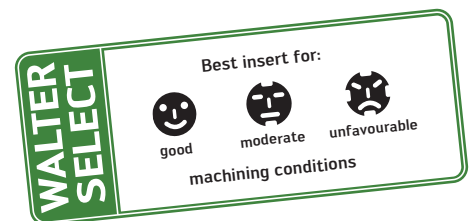

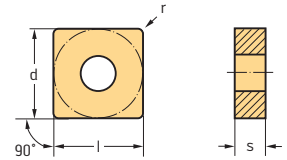

Negative basic shape SNMG/SNMA/SNMM

Tiger-tec® Silver



Indexable inserts

Designation	r mm	f mm	ap mm	P								M			K				S				
				HC								HC			HC				HC			HW	
				WPP10S	WPP20S	WPP30S	WMP20S	WPP05	WPP10	WPP20	WPP30	WMP20S	WSM10	WSM20	WSM30	WKK10S	WKK20S	WAK10	WAK20	WAK30	WSM10	WSM20	WSM30
 SNMA120408	0,8	0,25 - 0,50	0,8 - 5,0													☺	☺						
SNMA120412	1,2	0,30 - 0,60	1,2 - 5,0													☺	☺						
SNMA120416	1,6	0,35 - 0,70	1,5 - 5,0													☺	☺						
SNMA150612	1,2	0,30 - 0,65	1,2 - 7,0													☺	☺						
SNMA150616	1,6	0,35 - 0,80	1,5 - 7,0													☺	☺						
SNMA190612	1,2	0,30 - 0,65	1,2 - 8,0													☺	☺						
SNMA190616	1,6	0,35 - 0,80	1,5 - 8,0													☺	☺						
SNMA190624	2,4	0,40 - 0,90	2,5 - 8,0													☺	☺						
 SNMA120408T02020	0,8	0,25 - 0,50	0,8 - 5,0													☺	☺						
SNMA120412T02020	1,2	0,30 - 0,60	1,2 - 5,0													☺	☺						
SNMA120416T02020	1,6	0,35 - 0,70	1,5 - 5,0													☺	☺						
SNMA150612T02020	1,2	0,30 - 0,65	1,2 - 7,0													☺	☺						
SNMA150616T02020	1,6	0,35 - 0,80	1,5 - 7,0													☺	☺						
SNMA190612T02020	1,2	0,30 - 0,65	1,2 - 8,0													☺	☺						
SNMA190616T02020	1,6	0,35 - 0,80	1,5 - 8,0													☺	☺						
 SNMM120408-NRF	0,8	0,30 - 0,50	0,8 - 7,0	☹	☹																		
SNMM120412-NRF	1,2	0,35 - 0,70	1,2 - 7,0	☺	☹	☹	☹	☺															
SNMM120416-NRF	1,6	0,40 - 0,90	1,6 - 7,0	☺	☹	☹	☹	☺															
SNMM150612-NRF	1,2	0,35 - 0,75	1,2 - 9,0	☺	☹	☹	☹	☺															
SNMM150616-NRF	1,6	0,40 - 0,90	1,6 - 9,0	☺	☹	☹	☹	☺															
SNMM150624-NRF	2,4	0,45 - 1,10	2,0 - 9,0	☺	☹	☹	☹	☺															
SNMM190612-NRF	1,2	0,35 - 0,75	1,2 - 10,0	☺	☹	☹	☹	☺															
SNMM190616-NRF	1,6	0,40 - 1,00	1,6 - 10,0	☺	☹	☹	☹	☺															
SNMM190624-NRF	2,4	0,45 - 1,20	2,0 - 10,0	☺	☹	☹	☹	☺															
SNMM250716-NRF	1,6	0,45 - 1,00	1,6 - 12,0		☹	☹																	
SNMM250724-NRF	2,4	0,55 - 1,20	2,5 - 12,0		☹	☹																	
SNMM250916-NRF	1,6	0,45 - 1,00	1,6 - 12,0	☹	☹	☹																	
SNMM250924-NRF	2,4	0,55 - 1,20	2,5 - 12,0	☹	☹	☹																	

For dimensions, see the ISO 1832 designation key from page A-4 onwards.
For achievable surface finish qualities and technical information, see page A 298 in the Walter General catalogue 2012.

HC = Coated carbide
HW = Uncoated carbide



☹ ☹ ☹ New addition to range

Negative basic shape SNMG/SNMA/SNMM

Tiger-tec® Silver

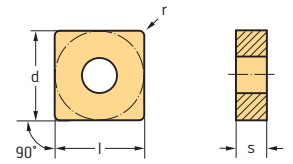

Indexable inserts

Designation	r mm	f mm	ap mm	P				M			K				S											
				HC				HC			HC				HC	HW										
				WPP10S	WPP20S	WPP30S	WMP20S	WPP05	WPP10	WPP20	WPP30	WMP20S	WSM10	WSM20	WSM30	WKK10S	WKK20S	WAK10	WAK20	WAK30	WSM10	WSM20	WSM30	WS10		
	SNMM190616-NR6	1,6	0,45 - 0,95	2,0 - 10,0					☺	☺	☹															
	SNMM190624-NR6	2,4	0,55 - 1,25	2,5 - 10,0						☺	☹															
	SNMM250716-NR6	1,6	0,45 - 1,00	2,0 - 12,0							☺	☹														
	SNMM150612-NRR	1,2	0,50 - 0,80	1,5 - 10,0	☹	☹	☹													☹						
	SNMM150616-NRR	1,6	0,45 - 1,00	2,0 - 12,0	☺	☹	☹														☹					
	SNMM150624-NRR	2,4	0,50 - 1,40	2,5 - 12,0	☹	☹	☹																			
	SNMM190612-NRR	1,2	0,50 - 1,00	2,0 - 13,0	☺	☹	☹															☹				
	SNMM190616-NRR	1,6	0,50 - 1,10	2,5 - 13,0	☺	☹	☹															☹				
	SNMM190624-NRR	2,4	0,60 - 1,60	3,0 - 13,0	☺	☹	☹															☹				
	SNMM250716-NRR	1,6	0,50 - 1,10	2,5 - 17,0	☺	☹	☹															☹				
	SNMM250724-NRR	2,4	0,60 - 1,60	3,0 - 17,0	☺	☹	☹															☹				
	SNMM250732-NRR	3,2	0,60 - 1,80	4,0 - 17,0	☹	☹	☹																			
	SNMM250916-NRR	1,6	0,50 - 1,10	2,5 - 17,0	☺	☹	☹															☹				
	SNMM250924-NRR	2,4	0,60 - 1,60	3,0 - 17,0	☺	☹	☹															☹				
	SNMM250932-NRR	3,2	0,60 - 1,80	4,0 - 17,0	☹	☹	☹															☹				

For dimensions, see the ISO 1832 designation key from page A-4 onwards.
For achievable surface finish qualities and technical information, see page A 298 in the Walter General catalogue 2012.

HC = Coated carbide
HW = Uncoated carbide

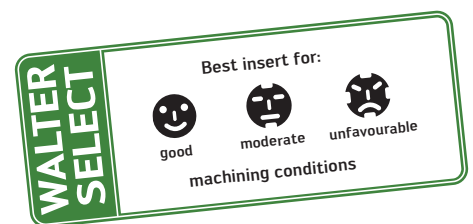

Negative basic shape
TNMG/TNMA/TNMM

Tiger-tec® Silver

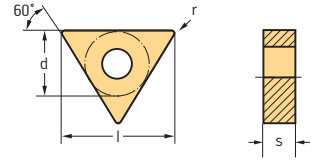

Indexable inserts

Designation	r mm	f mm	ap mm	P								M			K				S						
				HC								HC			HC				HC			HW			
				WPP10S	WPP20S	WPP30S	WMP20S	WPP05	WPP10	WPP20	WPP30	WMP20S	WSM10	WSM20	WSM30	WKK10S	WKK20S	WAK10	WAK20	WAK30	WSM10	WSM20	WSM30	WS10	
	TNMG160404-NF4	0,4	0,05 - 0,12	0,2 - 1,0																					
	TNMG160408-NF4	0,8	0,07 - 0,16	0,4 - 1,5																					
	TNMG160412-NF4	1,2	0,10 - 0,20	0,5 - 1,6																					
	TNMG110304-FP5	0,4	0,04 - 0,15	0,1 - 1,2	☺	☺																			
	TNMG110308-FP5	0,8	0,08 - 0,20	0,2 - 1,5	☺	☺																			
	TNMG160404-FP5	0,4	0,04 - 0,20	0,1 - 1,5	☺	☺																			
	TNMG160408-FP5	0,8	0,08 - 0,25	0,2 - 2,0	☺	☺																			
	TNMG160412-FP5	1,2	0,10 - 0,25	0,5 - 2,5	☺	☺																			
	TNMG160404-NMT	0,4	0,08 - 0,20	0,6 - 3,0								☹									☹		☹		
	TNMG160408-NMT	0,8	0,12 - 0,30	1,0 - 4,0								☹									☹		☹		
	TNMG160404-NMS	0,4	0,09 - 0,22	0,6 - 2,5								☺	☺	☹						☺	☺	☹			
	TNMG160408-NMS	0,8	0,11 - 0,30	0,8 - 3,5								☺	☺	☹						☺	☺	☹			
	TNMG110304-MP3	0,4	0,06 - 0,18	0,3 - 2,0	☺	☺																			
	TNMG110308-MP3	0,8	0,10 - 0,25	0,6 - 2,2	☺	☺																			
	TNMG160404-MP3	0,4	0,08 - 0,22	0,3 - 2,2	☺	☺	☹																		
	TNMG160408-MP3	0,8	0,12 - 0,32	0,6 - 3,0	☺	☺	☹																		
	TNMG160412-MP3	1,2	0,16 - 0,40	0,8 - 3,2	☺	☺	☹																		
	TNMG220408-MP3	0,8	0,12 - 0,32	0,6 - 3,2	☺	☺	☹																		
	TNMG220412-MP3	1,2	0,16 - 0,40	0,8 - 3,5	☺	☺	☹																		
	TNMG160404-NM4	0,4	0,10 - 0,18	0,5 - 2,0				☺	☺	☺	☹	☺	☺	☹					☺	☺	☹				
	TNMG160408-NM4	0,8	0,15 - 0,25	0,8 - 3,0				☺	☺	☺	☹	☺	☺	☹					☺	☺	☹				
	TNMG160412-NM4	1,2	0,20 - 0,35	1,0 - 4,0				☺	☺	☺	☹	☺	☺	☹					☺	☺	☹				
	TNMG160416-NM4	1,6	0,20 - 0,35	1,0 - 4,0								☺	☺	☹						☺	☺	☹			
	TNMG220408-NM4	0,8	0,18 - 0,35	0,8 - 5,0				☺	☺	☺	☹														
	TNMG220412-NM4	1,2	0,20 - 0,40	1,0 - 5,0				☺	☺	☺	☹														

For dimensions, see the ISO 1832 designation key from page A-4 onwards.
For achievable surface finish qualities and technical information, see page A 298 in the Walter General catalogue 2012.

HC = Coated carbide
HW = Uncoated carbide



☺ ☹ ☹ New addition to range

Negative basic shape TNMG/TNMA/TNMM

Tiger-tec® Silver

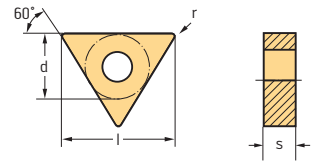

Indexable inserts

Designation	r mm	f mm	ap mm	P HC							M HC			K HC				S HC		HW									
				WPP10S	WPP20S	WPP30S	WMP20S	WPP05	WPP10	WPP20	WPP30	WMP20S	WSM10	WSM20	WSM30	WKK10S	WKK20S	WAK10	WAK20		WAK30	WSM10	WSM20	WSM30	WS10				
TNMG160404-MP5	0,4	0,16 - 0,25	0,5 - 4,0	☺	☺	☺																							
TNMG160408-MP5	0,8	0,18 - 0,35	0,6 - 4,0	☺	☺	☺																							
TNMG160412-MP5	1,2	0,20 - 0,40	1,0 - 4,0	☺	☺	☺																							
TNMG220408-MP5	0,8	0,18 - 0,35	0,8 - 5,0	☺	☺	☺																							
TNMG220412-MP5	1,2	0,20 - 0,40	1,0 - 5,0	☺	☺	☺																							
TNMG110308-MK5	0,8	0,20 - 0,40	0,8 - 3,5											☺	☺														
TNMG160404-MK5	0,4	0,16 - 0,25	0,6 - 4,0											☺	☺														
TNMG160408-MK5	0,8	0,25 - 0,45	0,8 - 5,0											☺	☺														
TNMG160412-MK5	1,2	0,30 - 0,45	1,2 - 5,0											☺	☺														
TNMG160416-MK5	1,6	0,35 - 0,45	1,5 - 5,0											☺	☺														
TNMG220408-MK5	0,8	0,25 - 0,45	1,0 - 6,0											☺	☺														
TNMG220412-MK5	1,2	0,30 - 0,45	1,4 - 6,0											☺	☺														
TNMG220416-MK5	1,6	0,35 - 0,45	1,6 - 6,0											☺	☺														
TNMG270612-MK5	1,2	0,35 - 0,65	1,2 - 8,0											☺	☺														
TNMG270616-MK5	1,6	0,45 - 0,90	3,0 - 9,0											☺	☺														
TNMG160404-NM5	0,4	0,16 - 0,25	0,6 - 4,0													☺	☺												
TNMG160408-NM5	0,8	0,25 - 0,45	0,8 - 5,0													☺	☺												
TNMG160412-NM5	1,2	0,30 - 0,45	1,2 - 5,0													☺	☺												
TNMG160416-NM5	1,6	0,35 - 0,45	1,5 - 5,0													☺	☺												
TNMG220408-NM5	0,8	0,25 - 0,45	1,0 - 6,0													☺	☺												
TNMG220412-NM5	1,2	0,30 - 0,45	1,4 - 6,0													☺	☺												
TNMG220416-NM5	1,6	0,35 - 0,45	1,6 - 6,0													☺	☺												
TNMG270616-NM6	1,6	0,45 - 0,90	3,0 - 9,0																										
TNMG270624-NM6	2,4	0,55 - 1,00	3,0 - 9,0																										

For dimensions, see the ISO 1832 designation key from page A-4 onwards.
For achievable surface finish qualities and technical information, see page A 298 in the Walter General catalogue 2012.

HC = Coated carbide
HW = Uncoated carbide

WALTER
SELECT

Best insert for:

☺
good

☹
moderate

☹
unfavourable

machining conditions

☺ ☹ ☹ New addition to range

Negative basic shape TNMG/TNMA/TNMM

Tiger-tec® Silver

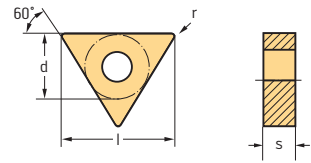

Indexable inserts

Designation	r mm	f mm	ap mm	P HC								M HC			K HC				S HC		HW			
				WPP10S	WPP20S	WPP30S	WMP20S	WPP05	WPP10	WPP20	WPP30	WMP20S	WSM10	WSM20	WSM30	WKK10S	WKK20S	WAK10	WAK20	WAK30		WSM10	WSM20	WSM30
								☺	☺	☺	☺					☺	☺	☺	☺					
	TNMG160408-NM9	0,8	0,20 - 0,40	1,0 - 5,0					☺	☺	☺	☺												
	TNMG160412-NM9	1,2	0,25 - 0,55	1,0 - 5,0					☺	☺	☺	☺												
	TNMG220408-NM9	0,8	0,20 - 0,45	2,0 - 7,0					☺	☺	☺	☺												
	TNMG220412-NM9	1,2	0,25 - 0,60	2,0 - 7,0					☺	☺	☺	☺												
	TNMG220416-NM9	1,6	0,35 - 0,70	2,0 - 7,0					☺	☺	☺	☺												
	TNMG160408-NR4	0,8	0,22 - 0,40	1,2 - 4,0					☺				☺	☺	☺						☺	☺		
	TNMG160412-NR4	1,2	0,25 - 0,50	1,5 - 4,5					☺				☺	☺	☺						☺	☺		
	TNMG220408-NR4	0,8	0,22 - 0,40	1,2 - 5,0									☺	☺	☺						☺	☺		
	TNMG220412-NR4	1,2	0,25 - 0,55	1,5 - 6,0									☺	☺	☺						☺	☺		
	TNMG220416-NR4	1,6	0,30 - 0,60	2,0 - 7,0									☺	☺	☺						☺	☺		
	TNMG270612-NR4	1,2	0,35 - 0,65	1,2 - 8,0									☺	☺	☺						☺	☺		
	TNMG160408-RP5	0,8	0,20 - 0,40	0,8 - 5,0	☺	☺	☺										☺							
	TNMG160412-RP5	1,2	0,25 - 0,55	1,0 - 5,0	☺	☺	☺										☺							
	TNMG220408-RP5	0,8	0,20 - 0,45	0,8 - 7,0	☺	☺	☺										☺							
	TNMG220412-RP5	1,2	0,25 - 0,60	1,0 - 7,0	☺	☺	☺										☺							
	TNMG220416-RP5	1,6	0,35 - 0,70	1,6 - 7,0	☺	☺	☺										☺							
	TNMA110308-RK5	0,8	0,15 - 0,35	1,0 - 4,0													☺							
	TNMA160404-RK5	0,4	0,16 - 0,25	0,6 - 5,0													☺							
	TNMA160408-RK5	0,8	0,25 - 0,45	0,8 - 5,0													☺							
	TNMA160412-RK5	1,2	0,30 - 0,50	1,2 - 5,0													☺							
	TNMA160416-RK5	1,6	0,25 - 0,60	1,5 - 5,0													☺							
	TNMA220408-RK5	0,8	0,25 - 0,45	1,0 - 6,0													☺							
	TNMA220412-RK5	1,2	0,30 - 0,55	1,4 - 6,0													☺							
	TNMA220416-RK5	1,6	0,35 - 0,60	1,6 - 6,0													☺							
	TNMA270616-RK5	1,6	0,40 - 0,65	1,8 - 7,0													☺							
	TNMA160408-RK7	0,8	0,25 - 0,45	0,8 - 5,0													☺							
	TNMA160412-RK7	1,2	0,30 - 0,50	1,2 - 5,0													☺							
	TNMA220408-RK7	0,8	0,25 - 0,45	1,0 - 6,0													☺							
	TNMA220412-RK7	1,2	0,30 - 0,55	1,4 - 6,0													☺							

For dimensions, see the ISO 1832 designation key from page A-4 onwards.
 For achievable surface finish qualities and technical information,
 see page A 298 in the Walter General catalogue 2012.

HC = Coated carbide
 HW = Uncoated carbide



A-120

Negative basic shape TNMG/TNMA/TNMM

Tiger-tec® Silver

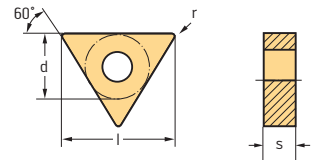

Indexable inserts

Designation	r mm	f mm	ap mm	P HC								M HC			K HC				S HC			HW				
				WPP10S	WPP20S	WPP30S	WMP20S	WPP05	WPP10	WPP20	WPP30	WMP20S	WSM10	WSM20	WSM30	WKK10S	WKK20S	WAK10	WAK20	WAK30	WSM10	WSM20	WSM30	WS10		
TNMA160404	0,4	0,16 - 0,25	0,6 - 5,0															☺	☹							
TNMA160408	0,8	0,25 - 0,45	0,8 - 5,0															☺	☹							
TNMA160412	1,2	0,30 - 0,50	1,2 - 5,0															☺	☹							
TNMA160416	1,6	0,25 - 0,60	1,5 - 5,0															☺	☹							
TNMA220408	0,8	0,25 - 0,45	1,0 - 6,0															☺	☹							
TNMA220412	1,2	0,30 - 0,55	1,4 - 6,0															☺	☹							
TNMA220416	1,6	0,35 - 0,60	1,6 - 6,0															☺	☹							
TNMA160408T02020	0,8	0,25 - 0,45	0,8 - 5,0															☺	☹							
TNMA160412T02020	1,2	0,30 - 0,55	1,2 - 5,0															☺	☹							
TNMA220412T02020	1,2	0,30 - 0,55	1,4 - 6,0															☺	☹							
TNMA220416T02020	1,6	0,35 - 0,60	1,6 - 6,0															☺	☹							
TNMM160408-NRF	0,8	0,30 - 0,45	0,8 - 6,0	☹	☹	☹																				
TNMM160412-NRF	1,2	0,35 - 0,50	1,2 - 6,0	☹	☹	☹																				
TNMM220408-NRF	0,8	0,30 - 0,50	0,8 - 7,0	☹	☹	☹																				
TNMM220412-NRF	1,2	0,35 - 0,60	1,2 - 7,0	☹	☹	☹	☺																			
TNMM220416-NRF	1,6	0,40 - 0,80	1,6 - 7,0	☹	☹	☹	☺																			
TNMM270612-NRF	1,2	0,35 - 0,65	1,2 - 8,0	☹	☹	☹																				
TNMM270616-NRF	1,6	0,40 - 0,85	1,6 - 8,0	☹	☹	☹																				
TNMM270616-NRR	1,6	0,50 - 1,10	2,0 - 13,0	☹	☹	☹															☹					
TNMM270624-NRR	2,4	0,60 - 1,60	3,0 - 13,0	☹	☹	☹															☹					

For dimensions, see the ISO 1832 designation key from page A-4 onwards.
For achievable surface finish qualities and technical information, see page A 298 in the Walter General catalogue 2012.

HC = Coated carbide
HW = Uncoated carbide

WALTER SELECT

Best insert for:

☺
good

☹
moderate

☹
unfavourable

machining conditions

Negative basic shape VNGG/VNMG/VNMA

Tiger-tec® Silver

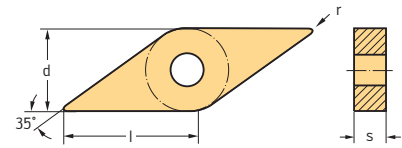

Indexable inserts

Designation	r mm	f mm	ap mm	P HC								M HC			K HC				S HC			HW					
				WPP10S	WPP20S	WPP30S	WMP20S	WPP05	WPP10	WPP20	WPP30	WMP20S	WSM10	WSM20	WSM30	WKK10S	WKK20S	WAK10	WAK20	WSM10	WSM20	WSM30	WS10				
VNGG160404-NFT	0,4	0,04 - 0,13	0,1 - 1,5																								
VNGG160408-NFT	0,8	0,06 - 0,16	0,2 - 2,0																								
VNGG160412-NFT	1,2	0,06 - 0,16	0,2 - 2,0																								
VNMG160404-NFT	0,4	0,05 - 0,15	0,2 - 1,5																								
VNMG160408-NFT	0,8	0,07 - 0,18	0,3 - 2,0																								
VNMG160404-FP5	0,4	0,04 - 0,22	0,1 - 1,5	☺	☺																						
VNMG160408-FP5	0,8	0,08 - 0,25	0,2 - 2,0	☺	☺																						
VNMG160404-NMS	0,4	0,08 - 0,16	0,5 - 1,5																								
VNMG160408-NMS	0,8	0,10 - 0,22	0,8 - 2,2																								
VNMG160404-MP3	0,4	0,08 - 0,22	0,3 - 2,2	☺	☺	☺																					
VNMG160408-MP3	0,8	0,12 - 0,32	0,6 - 3,0	☺	☺	☺																					
VNMG160412-MP3	1,2	0,16 - 0,35	0,8 - 3,2	☺	☺	☺																					
VNMG160404-NM4	0,4	0,10 - 0,18	0,5 - 2,0				☺	☺	☺	☺	☺	☺	☺	☺	☺												
VNMG160408-NM4	0,8	0,15 - 0,25	0,8 - 3,0				☺	☺	☺	☺	☺	☺	☺	☺	☺												
VNMG160412-NM4	1,2	0,20 - 0,40	0,8 - 4,0						☺	☺																	
VNMG160404-MK5	0,4	0,16 - 0,25	0,6 - 4,0												☺	☺											
VNMG160408-MK5	0,8	0,18 - 0,35	0,8 - 4,0												☺	☺											
VNMG160412-MK5	1,2	0,20 - 0,35	1,0 - 4,0												☺	☺											
VNMG160404-NM5	0,4	0,16 - 0,25	0,6 - 4,0														☺	☺									
VNMG160408-NM5	0,8	0,18 - 0,35	0,8 - 4,0														☺	☺									
VNMG160412-NM5	1,2	0,20 - 0,40	1,0 - 4,0														☺	☺									
VNMA160404-RK5	0,4	0,16 - 0,25	0,6 - 4,0														☺	☺									
VNMA160408-RK5	0,8	0,18 - 0,35	0,8 - 4,0														☺	☺									
VNMA160412-RK5	1,2	0,20 - 0,40	1,0 - 4,0														☺	☺									
VNMA160404	0,4	0,16 - 0,25	0,6 - 4,0														☺	☺									
VNMA160408	0,8	0,18 - 0,35	0,8 - 4,0														☺	☺									
VNMA160412	1,2	0,20 - 0,40	1,0 - 4,0														☺	☺									

For dimensions, see the ISO 1832 designation key from page A-4 onwards.
For achievable surface finish qualities and technical information, see page A 298 in the Walter General catalogue 2012.

HC = Coated carbide
HW = Uncoated carbide



New addition to range

Negative basic shape WNMG/WNMA/WNMM

Tiger-tec® Silver

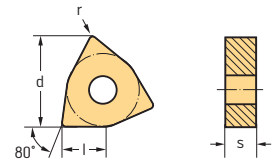

Indexable inserts

Designation	r mm	f mm	ap mm	P HC							M HC			K HC				S HC		HW			
				WPP10S	WPP20S	WPP30S	WMP20S	WPP01	WPP05	WPP10	WPP20	WPP30	WMP20S	WSM10	WSM20	WSM30	WKK10S	WKK20S	WAK10		WAK20	WSM10	WSM20
Wiper WNMG060404-NF	0,4	0,10 - 0,40	0,4 - 2,0					☺	☺	☺			☺								☺		
	0,8	0,15 - 0,50	0,5 - 3,0					☺	☺	☺			☺								☺		
	0,4	0,20 - 0,40	0,4 - 2,0					☺	☺	☺			☺								☺		
	0,8	0,25 - 0,55	0,5 - 3,0					☺	☺	☺			☺								☺		
	1,2	0,25 - 0,70	0,8 - 4,0					☺	☺	☺			☺								☺		
WNMG060404-NF4	0,4	0,05 - 0,12	0,2 - 1,0									☺	☺							☺	☺		
	0,8	0,07 - 0,16	0,4 - 1,5									☺	☺							☺	☺		
	0,4	0,05 - 0,12	0,2 - 1,0				☺					☺	☺							☺	☺		
	0,8	0,07 - 0,16	0,4 - 1,5				☺					☺	☺							☺	☺		
	1,2	0,10 - 0,20	0,5 - 1,6									☺	☺							☺	☺		
WNMG060404-FP5	0,4	0,04 - 0,20	0,1 - 1,5	☺	☺																		
	0,8	0,08 - 0,25	0,2 - 2,0	☺	☺																		
	0,4	0,05 - 0,20	0,1 - 1,5	☺	☺																		
	0,8	0,08 - 0,25	0,2 - 2,0	☺	☺																		
	1,2	0,10 - 0,25	0,5 - 2,5	☺	☺																		
Wiper WNMG060408-NM	0,8	0,20 - 0,55	0,8 - 3,0					☺	☺	☺										☺	☺		
	1,2	0,25 - 0,55	1,5 - 4,0					☺	☺	☺										☺	☺		
	0,8	0,20 - 0,55	0,8 - 3,0					☺	☺	☺			☺							☺	☺	☺	
	1,2	0,25 - 0,70	1,5 - 4,0					☺	☺	☺			☺							☺	☺	☺	
WNMG080408-NMT	0,8	0,12 - 0,30	0,8 - 4,0										☺							☺	☺	☺	
	1,2	0,15 - 0,32	1,0 - 4,0										☺							☺	☺	☺	
WNMG060408-NMS	0,8	0,10 - 0,30	0,8 - 3,0										☺	☺						☺	☺		
	0,4	0,10 - 0,24	0,6 - 2,5										☺	☺	☺					☺	☺	☺	
	0,8	0,13 - 0,32	0,8 - 3,5										☺	☺	☺					☺	☺	☺	

For dimensions, see the ISO 1832 designation key from page A-4 onwards.
For achievable surface finish qualities and technical information, see page A 298 in the Walter General catalogue 2012.

HC = Coated carbide
HW = Uncoated carbide

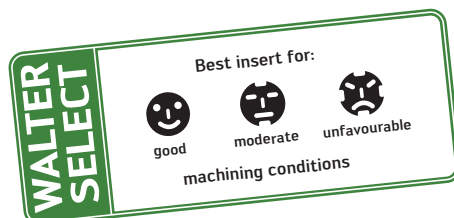

☺ ☺ ☺ New addition to range



Negative basic shape WNMG/WNMA/WNMM

Tiger-tec® Silver

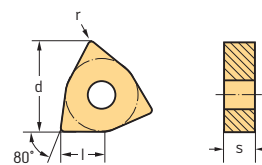

Indexable inserts

Designation	r mm	f mm	ap mm	P					M			K			S		HW									
				HC					HC			HC			HC											
				WPP10S	WPP20S	WPP30S	WMP20S	WPP01	WPP05	WPP10	WPP20	WPP30	WMP20S	WSM10	WSM20	WSM30	WKK10S	WKK20S	WAK10	WAK20	WSM10	WSM20	WSM30	WS10		
	WNMG060404-MP3	0,4	0,08 - 0,22	0,3 - 2,2	☺	☺	☺																			
	WNMG060408-MP3	0,8	0,12 - 0,32	0,6 - 3,0	☺	☺	☺																			
	WNMG060412-MP3	1,2	0,16 - 0,35	0,8 - 3,2	☺	☺	☺																			
	WNMG080404-MP3	0,4	0,08 - 0,22	0,3 - 2,5	☺	☺	☺																			
	WNMG080408-MP3	0,8	0,12 - 0,32	0,6 - 3,2	☺	☺	☺																			
	WNMG080412-MP3	1,2	0,16 - 0,40	0,8 - 3,5	☺	☺	☺																			
	WNMG060404-NM4	0,4	0,10 - 0,18	0,5 - 2,0				☺	☺	☺	☺	☺	☺	☺	☺	☺					☺	☺	☺			
	WNMG060408-NM4	0,8	0,15 - 0,25	0,8 - 2,5				☺	☺	☺	☺	☺	☺	☺	☺	☺					☺	☺	☺			
	WNMG060412-NM4	1,2	0,20 - 0,35	1,0 - 4,0					☺	☺	☺	☺			☺	☺						☺	☺			
	WNMG080404-NM4	0,4	0,10 - 0,18	0,5 - 2,0				☺		☺	☺	☺	☺	☺	☺	☺						☺	☺	☺		
	WNMG080408-NM4	0,8	0,15 - 0,25	0,8 - 3,0				☺	☺	☺	☺	☺	☺	☺	☺	☺						☺	☺	☺		
	WNMG080412-NM4	1,2	0,18 - 0,30	0,8 - 3,5				☺	☺	☺	☺	☺	☺	☺	☺	☺						☺	☺	☺		
	WNMG080416-NM4	1,6	0,25 - 0,45	1,2 - 5,0						☺	☺	☺			☺	☺							☺	☺		
	WNMG100608-NM4	0,8	0,25 - 0,50	0,8 - 7,0						☺	☺	☺			☺	☺							☺	☺		
	WNMG100612-NM4	1,2	0,30 - 0,50	1,0 - 7,0						☺	☺	☺			☺	☺							☺	☺		
	WNMG100616-NM4	1,6	0,35 - 0,55	1,2 - 7,0						☺	☺	☺											☺	☺		
	WNMG060404-MP5	0,4	0,16 - 0,25	0,5 - 4,0	☺	☺	☺																			
	WNMG060408-MP5	0,8	0,18 - 0,35	0,6 - 4,0	☺	☺	☺																			
	WNMG060412-MP5	1,2	0,20 - 0,40	1,0 - 4,0	☺	☺	☺																			
	WNMG080404-MP5	0,4	0,16 - 0,25	0,5 - 4,0	☺	☺	☺																			
	WNMG080408-MP5	0,8	0,18 - 0,40	0,6 - 5,0	☺	☺	☺																			
	WNMG080412-MP5	1,2	0,20 - 0,45	1,0 - 5,0	☺	☺	☺																			
	WNMG080416-MP5	1,6	0,25 - 0,50	1,2 - 5,0	☺	☺	☺																			
	WNMG100608-MP5	0,8	0,25 - 0,40	0,8 - 7,0	☺	☺	☺																			
	WNMG100612-MP5	1,2	0,30 - 0,50	1,0 - 7,0	☺	☺	☺																			
	WNMG100616-MP5	1,6	0,35 - 0,55	1,2 - 7,0	☺	☺	☺																			

For dimensions, see the ISO 1832 designation key from page A-4 onwards.
For achievable surface finish qualities and technical information,
see page A 298 in the Walter General catalogue 2012.

HC = Coated carbide
HW = Uncoated carbide

Negative basic shape WNMG/WNMA/WNMM

Tiger-tec® Silver

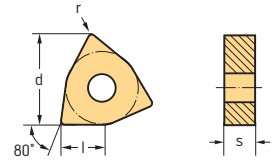

Indexable inserts

Designation	r mm	f mm	ap mm	P HC							M HC			K HC				S HC		HW				
				WPP10S	WPP20S	WPP30S	WMP20S	WPP01	WPP05	WPP10	WPP20	WPP30	WMP20S	WSM10	WSM20	WSM30	WKK10S	WKK20S	WAK10		WAK20	WSM10	WSM20	WSM30
	WNMG060404-MK5	0,4	0,16 - 0,25	0,6 - 4,0											☺	☺								
	WNMG060408-MK5	0,8	0,20 - 0,40	0,8 - 4,0											☺	☺								
	WNMG060412-MK5	1,2	0,16 - 0,45	0,6 - 4,0											☺	☺								
	WNMG080404-MK5	0,4	0,16 - 0,25	0,6 - 5,0											☺	☺								
	WNMG080408-MK5	0,8	0,20 - 0,45	1,2 - 5,0											☺	☺								
	WNMG080412-MK5	1,2	0,22 - 0,50	1,5 - 5,0											☺	☺								
	WNMG080416-MK5	1,6	0,25 - 0,55	2,0 - 5,0											☺	☺								
	WNMG100608-MK5	0,8	0,25 - 0,50	0,8 - 7,0											☺	☺								
	WNMG100612-MK5	1,2	0,30 - 0,60	1,2 - 7,0											☺	☺								
WNMG100616-MK5	1,6	0,35 - 0,60	1,5 - 7,0											☺	☺									
	WNMG060404-NM5	0,4	0,16 - 0,25	0,6 - 4,0												☺	☺							
	WNMG060408-NM5	0,8	0,20 - 0,40	0,8 - 4,0												☺	☺							
	WNMG060412-NM5	1,2	0,22 - 0,50	1,2 - 4,0												☺	☺							
	WNMG080404-NM5	0,4	0,16 - 0,25	0,6 - 5,0												☺	☺							
	WNMG080408-NM5	0,8	0,20 - 0,45	1,2 - 5,0												☺	☺							
	WNMG080412-NM5	1,2	0,22 - 0,50	1,5 - 5,0												☺	☺							
	WNMG080416-NM5	1,6	0,25 - 0,55	2,0 - 5,0												☺	☺							
	WNMG100608-NM5	0,8	0,25 - 0,50	0,8 - 7,0												☺	☺							
	WNMG100612-NM5	1,2	0,30 - 0,60	1,2 - 7,0												☺	☺							
WNMG100616-NM5	1,6	0,35 - 0,60	1,5 - 7,0												☺	☺								
	WNMG080408-NM6	0,8	0,16 - 0,45	1,0 - 5,0						☺	☺	☺												
	WNMG080412-NM6	1,2	0,20 - 0,45	1,5 - 5,0						☺	☺	☺												
	WNMG100608-NM6	0,8	0,25 - 0,45	1,0 - 8,0						☺	☺	☺												
	WNMG100612-NM6	1,2	0,25 - 0,60	1,5 - 8,0						☺	☺	☺												
	WNMG100616-NM6	1,6	0,35 - 0,70	2,0 - 8,0						☺	☺	☺												

For dimensions, see the ISO 1832 designation key from page A-4 onwards.
For achievable surface finish qualities and technical information,
see page A 298 in the Walter General catalogue 2012.

HC = Coated carbide
HW = Uncoated carbide

WALTER SELECT

Best insert for:

☺
good

☹
moderate

☹
unfavourable

machining conditions

☺☹☹ New addition to range

Negative basic shape WNMG/WNMA/WNMM

Tiger-tec® Silver

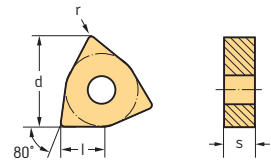

Indexable inserts

Designation	r mm	f mm	ap mm	P							M			K				S		HW					
				HC							HC			HC				HC							
				WPP10S	WPP20S	WPP30S	WMP20S	WPP01	WPP05	WPP10	WPP20	WPP30	WMP20S	WSM10	WSM20	WSM30	WKK10S	WKK20S	WAK10	WAK20	WSM10	WSM20	WSM30	WS10	
	WNMG060408-NM9	0,8	0,20 - 0,40	0,8 - 4,0						☺	☺	☺													
	WNMG060412-NM9	1,2	0,25 - 0,50	0,8 - 4,0						☺	☺	☺													
	WNMG080408-NM9	0,8	0,20 - 0,40	1,0 - 6,0						☺	☺	☺	☺												
	WNMG080412-NM9	1,2	0,25 - 0,55	1,0 - 6,0						☺	☺	☺	☺												
	WNMG080416-NM9	1,6	0,35 - 0,65	1,0 - 6,0						☺	☺	☺	☺												
	WNMG100612-NM9	1,2	0,25 - 0,60	2,0 - 8,0						☺	☺	☺	☺												
	WNMG100616-NM9	1,6	0,35 - 0,70	2,0 - 8,0						☺	☺	☺	☺												
	WNMG080408-NRS	0,8	0,16 - 0,35	1,0 - 4,0									☺	☺						☺	☺				
	WNMG080412-NRS	1,2	0,18 - 0,40	1,2 - 4,0									☺	☺						☺	☺				
	WNMG060408-NR4	0,8	0,22 - 0,40	1,2 - 3,5										☺	☺						☺	☺			
	WNMG060412-NR4	1,2	0,25 - 0,50	1,5 - 3,5										☺	☺						☺	☺			
	WNMG080408-NR4	0,8	0,22 - 0,40	1,2 - 4,5									☺	☺	☺					☺	☺	☺			
	WNMG080412-NR4	1,2	0,25 - 0,50	1,5 - 4,5									☺	☺	☺					☺	☺	☺			
	WNMG100608-NR4	0,8	0,22 - 0,45	1,2 - 6,0										☺	☺						☺	☺			
	WNMG100612-NR4	1,2	0,25 - 0,60	1,5 - 6,0										☺	☺						☺	☺			
	WNMG100616-NR4	1,6	0,30 - 0,65	2,0 - 6,0										☺	☺						☺	☺			
	WNMG060408-RP5	0,8	0,20 - 0,40	0,8 - 4,0	☺	☺	☺																		
	WNMG060412-RP5	1,2	0,25 - 0,50	1,0 - 4,0	☺	☺	☺																		
	WNMG080408-RP5	0,8	0,20 - 0,40	0,8 - 6,0	☺	☺	☺											☺							
	WNMG080412-RP5	1,2	0,25 - 0,60	1,0 - 6,0	☺	☺	☺											☺							
	WNMG080416-RP5	1,6	0,35 - 0,70	1,6 - 6,0	☺	☺	☺																		
	WNMG100612-RP5	1,2	0,25 - 0,60	1,2 - 8,0	☺	☺	☺																		
	WNMG100616-RP5	1,6	0,35 - 0,70	1,6 - 8,0	☺	☺	☺																		

For dimensions, see the ISO 1832 designation key from page A-4 onwards.
For achievable surface finish qualities and technical information,
see page A 298 in the Walter General catalogue 2012.

HC = Coated carbide
HW = Uncoated carbide

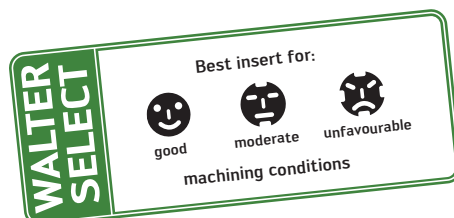

☺ ☺ ☺ New addition to range

Negative basic shape WNMG/WNMA/WNMM

Tiger-tec® Silver

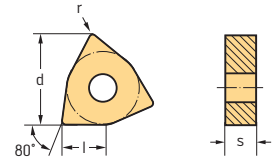

Indexable inserts

Designation	r mm	f mm	ap mm	P							M			K			S							
				HC							HC			HC			HC	HW						
				WPP10S	WPP20S	WPP30S	WMP20S	WPP01	WPP05	WPP10	WPP20	WPP30	WMP20S	WSM10	WSM20	WSM30	WKK10S	WKK20S	WAK10	WAK20	WSM10	WSM20	WSM30	WS10
	WNMA060404-RK5	0,4	0,16 - 0,25	0,6 - 4,0																				
	WNMA060408-RK5	0,8	0,20 - 0,40	0,8 - 4,0																				
	WNMA060412-RK5	1,2	0,22 - 0,50	1,2 - 4,0																				
	WNMA080404-RK5	0,4	0,16 - 0,25	0,6 - 5,0																				
	WNMA080408-RK5	0,8	0,20 - 0,45	1,2 - 5,0																				
	WNMA080412-RK5	1,2	0,22 - 0,50	1,5 - 5,0																				
	WNMA100612-RK5	1,2	0,25 - 0,60	1,5 - 6,0																				
	WNMA100616-RK5	1,6	0,30 - 0,65	1,5 - 6,0																				
	WNMA060408-RK7	0,8	0,20 - 0,40	0,8 - 4,0																				
	WNMA080408-RK7	0,8	0,20 - 0,45	1,2 - 5,0																				
	WNMA080412-RK7	1,2	0,22 - 0,50	1,5 - 5,0																				
	WNMA060404	0,4	0,16 - 0,25	0,6 - 4,0																				
	WNMA060408	0,8	0,20 - 0,40	0,8 - 4,0																				
	WNMA060412	1,2	0,22 - 0,50	1,2 - 4,0																				
	WNMA080404	0,4	0,16 - 0,25	0,6 - 5,0																				
	WNMA080408	0,8	0,20 - 0,45	1,2 - 5,0																				
	WNMA080412	1,2	0,22 - 0,50	1,5 - 5,0																				
	WNMA100612	1,2	0,30 - 0,65	1,2 - 7,0																				
	WNMA100616	1,6	0,35 - 0,80	1,5 - 7,0																				
	WNMA060408T02020	0,8	0,20 - 0,40	0,8 - 4,0																				
	WNMA080408T02020	0,8	0,20 - 0,45	1,2 - 5,0																				
	WNMA080412T02020	1,2	0,22 - 0,50	1,5 - 5,0																				
	WNMA100612T02020	1,2	0,30 - 0,65	1,2 - 7,0																				
	WNMA100616T02020	1,6	0,35 - 0,80	1,5 - 7,0																				
	WNMM080412-NRF	1,2	0,35 - 0,60	1,2 - 6,0	☺	☺	☺																	
	WNMM100612-NRF	1,2	0,35 - 0,70	1,2 - 8,0	☺	☺	☺		☺															
	WNMM100616-NRF	1,6	0,40 - 0,90	1,6 - 8,0	☺	☺	☺		☺															

For dimensions, see the ISO 1832 designation key from page A-4 onwards.
For achievable surface finish qualities and technical information,
see page A 298 in the Walter General catalogue 2012.

HC = Coated carbide
HW = Uncoated carbide

Positive basic shape CCGT/CCMT/CCMW

Tiger-tec®

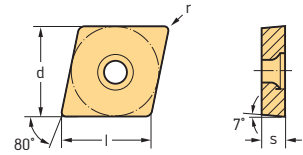

Indexable inserts

Designation	l mm	r mm	f mm	ap mm	P				M			K			N		S		
					HC				HC			HC			HC	HW	HC		
					WPP01	WPP10	WPP20	WPP30	WSM10	WSM20	WSM30	WAK10	WAK20	WAK30	WXN10	WK1	WSM10	WSM20	WSM30
Wiper	CCMT060204-PF	6,45	0,4	0,05 - 0,30	0,3 - 2,0	☺	☺	☺	☺	☺	☺	☺						☺	☺
	CCMT060208-PF	6,45	0,8	0,09 - 0,35	0,3 - 2,0	☺	☺	☺	☺	☺	☺	☺						☺	☺
	CCMT09T304-PF	9,67	0,4	0,07 - 0,30	0,3 - 3,0	☺	☺	☺	☺	☺	☺	☺						☺	☺
	CCMT09T308-PF	9,67	0,8	0,12 - 0,45	0,3 - 3,0	☺	☺	☺	☺	☺	☺	☺						☺	☺
	CCGT060201-PF2	6,45	0,1	0,02 - 0,06	0,1 - 1,5					☺	☺				☺	☺	☺		
	CCGT060202-PF2	6,45	0,2	0,05 - 0,12	0,2 - 2,0					☺	☺				☺	☺	☺		
	CCGT060204-PF2	6,45	0,4	0,08 - 0,25	0,2 - 2,5					☺	☺				☺	☺	☺		
	CCGT09T301-PF2	9,67	0,1	0,02 - 0,06	0,1 - 1,5					☺	☺				☺	☺	☺		
	CCGT09T302-PF2	9,67	0,2	0,05 - 0,12	0,2 - 2,0					☺	☺				☺	☺	☺		
	CCGT09T304-PF2	9,67	0,4	0,08 - 0,25	0,2 - 2,5					☺	☺				☺	☺	☺	☺	
	CCGT09T308-PF2	9,67	0,8	0,10 - 0,30	0,3 - 3,0					☺	☺				☺	☺	☺	☺	
	CCGT120404-PF2	12,9	0,4	0,08 - 0,25	0,2 - 3,0					☺	☺				☺	☺	☺	☺	
CCGT120408-PF2	12,9	0,8	0,10 - 0,30	0,3 - 3,5					☺	☺				☺	☺	☺	☺		
	CCMT060202-PF4	6,45	0,2	0,04 - 0,12	0,1 - 1,0	☺	☺	☺	☺	☺	☺	☺				☺	☺	☺	☺
	CCMT060204-PF4	6,45	0,4	0,05 - 0,16	0,1 - 1,5	☺	☺	☺	☺	☺	☺	☺				☺	☺	☺	☺
	CCMT060208-PF4	6,45	0,8	0,08 - 0,20	0,1 - 2,5	☺	☺	☺	☺	☺	☺	☺				☺	☺	☺	☺
	CCMT09T302-PF4	9,67	0,2	0,04 - 0,12	0,1 - 1,0	☺	☺	☺	☺	☺	☺	☺				☺	☺	☺	☺
	CCMT09T304-PF4	9,67	0,4	0,05 - 0,16	0,1 - 1,5	☺	☺	☺	☺	☺	☺	☺				☺	☺	☺	☺
	CCMT09T308-PF4	9,67	0,8	0,08 - 0,20	0,1 - 2,5	☺	☺	☺	☺	☺	☺	☺				☺	☺	☺	☺
	CCMT120404-PF4	12,9	0,4	0,05 - 0,16	0,1 - 1,5	☺	☺	☺	☺	☺	☺	☺				☺	☺	☺	☺
	CCMT120408-PF4	12,9	0,8	0,08 - 0,20	0,1 - 2,5	☺	☺	☺	☺	☺	☺	☺				☺	☺	☺	☺
	CCGT060202-PF5	6,45	0,2	0,04 - 0,10	0,1 - 0,6		☺	☺	☺	☺	☺	☺							☺
	CCGT060204-PF5	6,45	0,4	0,06 - 0,12	0,2 - 0,6		☺	☺	☺	☺	☺	☺							☺
	CCGT09T302-PF5	9,67	0,2	0,04 - 0,10	0,1 - 1,0		☺	☺	☺	☺	☺	☺							☺
	CCGT09T304-PF5	9,67	0,4	0,06 - 0,12	0,2 - 1,0		☺	☺	☺	☺	☺	☺							☺

For dimensions, see the ISO 1832 designation key from page A-4 onwards.
For achievable surface finish qualities and technical information, see page A 298 in the Walter General catalogue 2012.

HC = Coated carbide
HW = Uncoated carbide

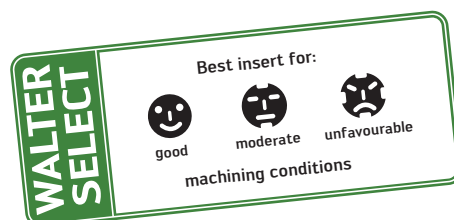

☺ ☺ ☺ New addition to range

Positive basic shape CCGT/CCMT/CCMW

Tiger-tec®

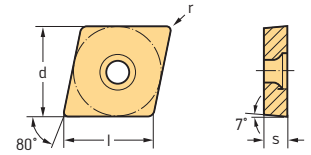

Indexable inserts

Designation	l mm	r mm	f mm	ap mm	P			M			K			N		S			
					HC			HC			HC			HC	HW	HC			
					WPP01	WPP10	WPP20	WPP30	WSM10	WSM20	WSM30	WAK10	WAK20	WAK30	WXN10	WK1	WSM10	WSM20	WSM30
	CCMT060204-PS5	6,45	0,4	0,08 - 0,25	0,3 - 1,6	☺	☺			☺	☺	☺					☺	☺	
	CCMT060208-PS5	6,45	0,8	0,12 - 0,30	0,5 - 1,6	☺	☺			☺	☺	☺					☺	☺	
	CCMT09T304-PS5	9,67	0,4	0,08 - 0,25	0,3 - 2,0	☺	☺			☺	☺	☺					☺	☺	
	CCMT09T308-PS5	9,67	0,8	0,12 - 0,32	0,5 - 2,0	☺	☺			☺	☺	☺					☺	☺	
	CCMT120404-PS5	12,9	0,4	0,10 - 0,25	0,3 - 2,5	☺	☺			☺	☺	☺					☺	☺	
	CCMT120408-PS5	12,9	0,8	0,12 - 0,32	0,5 - 2,5	☺	☺			☺	☺	☺					☺	☺	
	CCMT09T304-PM	9,67	0,4	0,12 - 0,40	0,5 - 4,0	☺	☺					☺	☺						
	CCMT09T308-PM	9,67	0,8	0,15 - 0,50	0,7 - 4,0	☺	☺					☺	☺						
	CCMT09T312-PM	9,67	1,2	0,17 - 0,50	0,7 - 4,0	☺	☺					☺	☺						
	CCMT120404-PM	12,9	0,4	0,15 - 0,40	0,5 - 4,0	☺	☺					☺	☺						
	CCMT120408-PM	12,9	0,8	0,15 - 0,50	0,7 - 4,0	☺	☺					☺	☺						
	CCMT120412-PM	12,9	1,2	0,17 - 0,60	0,7 - 4,0	☺	☺					☺	☺						
	CCGT060201-PM2	6,45	0,1	0,02 - 0,06	0,5 - 1,5										☺	☺			
	CCGT060202-PM2	6,45	0,2	0,05 - 0,12	0,5 - 2,0										☺	☺			
	CCGT060204-PM2	6,45	0,4	0,08 - 0,25	0,6 - 3,0										☺	☺			
	CCGT09T301-PM2	9,67	0,1	0,02 - 0,06	0,5 - 1,5										☺	☺			
	CCGT09T302-PM2	9,67	0,2	0,05 - 0,12	0,5 - 2,0										☺	☺			
	CCGT09T304-PM2	9,67	0,4	0,08 - 0,25	0,6 - 4,0										☺	☺			
	CCGT09T308-PM2	9,67	0,8	0,10 - 0,35	0,8 - 4,0										☺	☺			
	CCGT120402-PM2	12,9	0,2	0,05 - 0,12	0,5 - 2,0										☺	☺			
	CCGT120404-PM2	12,9	0,4	0,08 - 0,25	0,6 - 5,0										☺	☺			
CCGT120408-PM2	12,9	0,8	0,10 - 0,35	0,8 - 5,0										☺	☺				
	CCMT060204-PM5	6,45	0,4	0,12 - 0,25	0,4 - 2,5	☺	☺	☺	☺	☺	☺	☺	☺			☺	☺	☺	☺
	CCMT060208-PM5	6,45	0,8	0,16 - 0,30	0,6 - 2,5	☺	☺	☺	☺	☺	☺	☺	☺			☺	☺	☺	☺
	CCMT09T304-PM5	9,67	0,4	0,12 - 0,25	0,4 - 3,0	☺	☺	☺	☺	☺	☺	☺	☺			☺	☺	☺	☺
	CCMT09T308-PM5	9,67	0,8	0,16 - 0,35	0,6 - 4,0	☺	☺	☺	☺	☺	☺	☺	☺			☺	☺	☺	☺
	CCMT120404-PM5	12,9	0,4	0,12 - 0,25	0,4 - 3,0	☺	☺	☺	☺	☺	☺	☺	☺			☺	☺	☺	☺
	CCMT120408-PM5	12,9	0,8	0,16 - 0,40	0,6 - 5,0	☺	☺	☺	☺	☺	☺	☺	☺			☺	☺	☺	☺
	CCMT120412-PM5	12,9	1,2	0,20 - 0,50	0,8 - 5,0	☺	☺	☺	☺	☺	☺	☺	☺			☺	☺	☺	☺

For dimensions, see the ISO 1832 designation key from page A-4 onwards.
For achievable surface finish qualities and technical information, see page A 298 in the Walter General catalogue 2012.

HC = Coated carbide
HW = Uncoated carbide



☺ ☺ ☺ New addition to range

Positive basic shape CCGT/CCMT/CCMW

Tiger-tec®

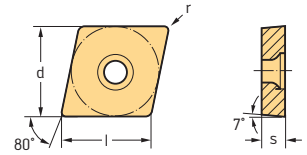

Indexable inserts

Designation	l mm	r mm	f mm	ap mm	P				M			K			N		S		
					HC				HC			HC			HC	HW	HC		
					WPP01	WPP10	WPP20	WPP30	WSM10	WSM20	WSM30	WAK10	WAK20	WAK30	WXN10	WK1	WSM10	WSM20	WSM30
CCMW060202	6,45	0,2	0,08 - 0,12	0,2 - 2,5								☺	☹						
CCMW060204	6,45	0,4	0,12 - 0,25	0,4 - 2,5								☺	☹						
CCMW060208	6,45	0,8	0,16 - 0,30	0,6 - 2,5								☺	☹						
CCMW09T304	9,67	0,4	0,12 - 0,25	0,4 - 3,0								☺	☹						
CCMW09T308	9,67	0,8	0,16 - 0,35	0,6 - 4,0								☺	☹						
CCMW120404	12,9	0,4	0,12 - 0,25	0,4 - 4,0								☺	☹						
CCMW120408	12,9	0,8	0,16 - 0,40	0,6 - 6,0								☺	☹						
CCMW120412	12,9	1,2	0,20 - 0,50	0,8 - 6,0								☺	☹						

For dimensions, see the ISO 1832 designation key from page A-4 onwards.

For achievable surface finish qualities and technical information, see page A 298 in the Walter General catalogue 2012.

HC = Coated carbide
HW = Uncoated carbide

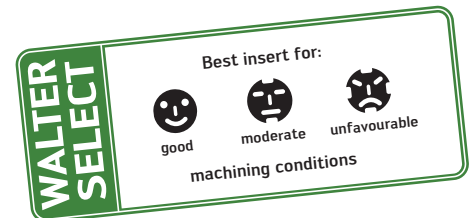

Positive basic shape DCGT/DCMT/DCMW

Tiger-tec®

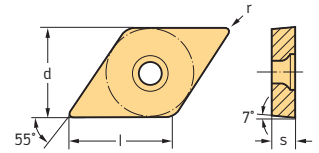

Indexable inserts

Designation	r mm	f mm	ap mm	P				M			K		N		S		
				HC				HC			HC	HC	HW	HC			
				WPP01	WPP10	WPP20	WPP30	WSM10	WSM20	WSM30	WAK10	WAK20	WXN10	WK1	WSM10	WSM20	WSM30
 Wiper	DCMT070204-PF	0,4	0,05 - 0,25	0,3 - 2,0	⊕	⊕	⊕	⊕	⊕	⊕	⊕				⊕	⊕	
	DCMT070208-PF	0,8	0,05 - 0,25	0,3 - 2,0	⊕	⊕	⊕	⊕	⊕	⊕	⊕				⊕	⊕	
	DCMT11T304-PF	0,4	0,07 - 0,30	0,3 - 3,0	⊕	⊕	⊕	⊕	⊕	⊕	⊕				⊕	⊕	
	DCMT11T308-PF	0,8	0,12 - 0,40	0,3 - 3,0	⊕	⊕	⊕	⊕	⊕	⊕	⊕				⊕	⊕	
	DCGT070201-PF2	0,1	0,02 - 0,06	0,1 - 1,5					⊕	⊕	⊕	⊕	⊕		⊕		
	DCGT070202-PF2	0,2	0,05 - 0,12	0,2 - 2,0					⊕	⊕	⊕	⊕	⊕		⊕		
	DCGT070204-PF2	0,4	0,08 - 0,25	0,2 - 2,5					⊕	⊕	⊕	⊕	⊕		⊕		
	DCGT11T301-PF2	0,1	0,02 - 0,06	0,1 - 1,5					⊕	⊕	⊕	⊕	⊕		⊕		
	DCGT11T302-PF2	0,2	0,05 - 0,12	0,2 - 2,0					⊕	⊕	⊕	⊕	⊕		⊕		
	DCGT11T304-PF2	0,4	0,08 - 0,25	0,2 - 2,5					⊕	⊕	⊕	⊕	⊕		⊕		
	DCGT11T308-PF2	0,8	0,10 - 0,30	0,3 - 3,0					⊕	⊕	⊕	⊕	⊕		⊕		
	DCMT070202-PF4	0,2	0,04 - 0,12	0,1 - 1,0	⊕	⊕	⊕	⊕	⊕	⊕	⊕			⊕	⊕	⊕	
	DCMT070204-PF4	0,4	0,05 - 0,16	0,1 - 1,5	⊕	⊕	⊕	⊕	⊕	⊕	⊕			⊕	⊕	⊕	
	DCMT070208-PF4	0,8	0,08 - 0,20	0,1 - 2,5	⊕	⊕	⊕	⊕	⊕	⊕	⊕			⊕	⊕	⊕	
	DCMT11T302-PF4	0,2	0,04 - 0,12	0,1 - 1,0	⊕	⊕	⊕	⊕	⊕	⊕	⊕			⊕	⊕	⊕	
	DCMT11T304-PF4	0,4	0,05 - 0,16	0,1 - 1,5	⊕	⊕	⊕	⊕	⊕	⊕	⊕			⊕	⊕	⊕	
	DCMT11T308-PF4	0,8	0,08 - 0,20	0,1 - 2,5	⊕	⊕	⊕	⊕	⊕	⊕	⊕			⊕	⊕	⊕	
	DCMT070204-PS5	0,4	0,08 - 0,25	0,3 - 1,6		⊕	⊕		⊕	⊕	⊕				⊕	⊕	
	DCMT070208-PS5	0,8	0,12 - 0,30	0,6 - 1,6		⊕	⊕		⊕	⊕	⊕				⊕	⊕	
	DCMT11T304-PS5	0,4	0,08 - 0,25	0,3 - 2,0		⊕	⊕		⊕	⊕	⊕				⊕	⊕	
	DCMT11T308-PS5	0,8	0,12 - 0,32	0,6 - 2,0		⊕	⊕		⊕	⊕	⊕				⊕	⊕	
 Wiper	DCMT11T304-PM	0,4	0,12 - 0,40	0,5 - 4,0		⊕	⊕		⊕	⊕	⊕				⊕		
	DCMT11T308-PM	0,8	0,15 - 0,50	0,5 - 4,0		⊕	⊕		⊕	⊕	⊕				⊕		



For dimensions, see the ISO 1832 designation key from page A-4 onwards.
For achievable surface finish qualities and technical information, see page A 298 in the Walter General catalogue 2012.

HC = Coated carbide
HW = Uncoated carbide

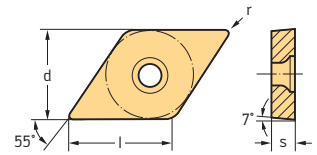
Positive basic shape DCGT/DCMT/DCMW

Tiger-tec®

Indexable inserts

Designation	r mm	f mm	ap mm	P				M			K		N		S		
				HC				HC			HC		HC	HW	HC		
				WPP01	WPP10	WPP20	WPP30	WSM10	WSM20	WSM30	WAK10	WAK20	WXN10	WK1	WSM10	WSM20	WSM30
 DCGT070201-PM2	0,1	0,02 - 0,06	0,5 - 1,5										☺	☺			
DCGT070202-PM2	0,2	0,05 - 0,12	0,5 - 2,0										☺	☺			
DCGT070204-PM2	0,4	0,08 - 0,25	0,6 - 2,5										☺	☺			
DCGT11T301-PM2	0,1	0,02 - 0,06	0,5 - 1,5										☺	☺			
DCGT11T302-PM2	0,2	0,05 - 0,12	0,5 - 2,0										☺	☺			
DCGT11T304-PM2	0,4	0,08 - 0,25	0,6 - 3,0										☺	☺			
DCGT11T308-PM2	0,8	0,10 - 0,30	0,8 - 3,5										☺	☺			
 DCMT070204-PM5	0,4	0,12 - 0,20	0,4 - 2,0		☺	☺	☺	☺	☺	☺	☺	☺			☺	☺	☺
DCMT070208-PM5	0,8	0,16 - 0,25	0,6 - 2,0		☺	☺	☺	☺	☺	☺	☺	☺			☺	☺	☺
DCMT11T304-PM5	0,4	0,12 - 0,25	0,4 - 3,0		☺	☺	☺	☺	☺	☺	☺	☺			☺	☺	☺
DCMT11T308-PM5	0,8	0,16 - 0,30	0,6 - 4,0		☺	☺	☺	☺	☺	☺	☺	☺			☺	☺	☺
DCMT11T312-PM5	1,2	0,20 - 0,35	0,8 - 4,0		☺	☺	☺	☺	☺	☺	☺	☺			☺	☺	☺
 DCMW11T304	0,4	0,12 - 0,25	0,4 - 3,0								☺	☺					
DCMW11T308	0,8	0,16 - 0,30	0,6 - 4,0								☺	☺					

For dimensions, see the ISO 1832 designation key from page A-4 onwards.

For achievable surface finish qualities and technical information, see page A 298 in the Walter General catalogue 2012.

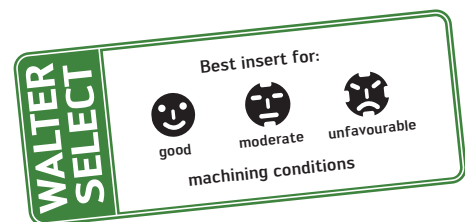
 HC = Coated carbide
 HW = Uncoated carbide

Positive basic shape RCGT/RCMT/RCMX

Tiger-tec® Silver

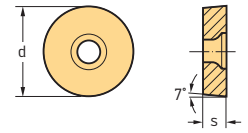

Indexable inserts

Designation	r mm	f mm	ap mm	P						M			K		N		S					
				HC						HC			HC		HW		HC		HW			
				WPP10S	WPP20S	WPP30S	WPP01	WPP10	WPP20	WPP30	WSM10	WSM20	WSM30	WKK20S	WAK10	WAK20	WXN10	WK1	WSM10	WSM20	WSM30	WS10
RCGT0602M0-PF2	3	0,06 - 0,25	0,2 - 2,0														☺	☺				
RCGT0803M0-PF2	4	0,08 - 0,30	0,3 - 3,0														☺	☺				
RCGT10T3M0-PF2	5	0,10 - 0,40	0,3 - 4,0														☺	☺				
RCGT1204M0-PF2	6	0,12 - 0,40	0,4 - 4,5														☺	☺				
RCMT0602M0-PF4	3	0,07 - 0,30	0,6 - 2,5					☺	☺		☺	☺	☺						☺	☺	☺	
RCMT0803M0-PF4	4	0,08 - 0,30	0,8 - 3,0					☺	☺		☺	☺	☺						☺	☺	☺	
RCMT10T3M0-PF4	5	0,10 - 0,35	1,0 - 4,0					☺	☺		☺	☺	☺						☺	☺	☺	
RCMT1204M0-PF4	6	0,12 - 0,40	1,2 - 5,0					☺	☺		☺	☺	☺						☺	☺	☺	
RCGT0502M0-PF5	2,5	0,07 - 0,25	0,6 - 2,5																			☺
RCGT0602M0-PF5	3	0,07 - 0,25	0,6 - 2,5						☺			☺									☺	☺
RCGT0803M0-PF5	4	0,08 - 0,30	0,8 - 3,0						☺			☺									☺	☺
RCGT10T3M0-PF5	5	0,10 - 0,35	1,0 - 4,0						☺			☺									☺	☺
RCGT1204M0-PF5	6	0,12 - 0,40	1,2 - 5,0																			☺
RCGT0602M0-PM2	3	0,10 - 0,55	0,6 - 2,5														☺	☺				
RCGT0803M0-PM2	4	0,12 - 0,60	0,7 - 3,0														☺	☺				
RCGT10T3M0-PM2	5	0,15 - 0,70	0,8 - 4,0														☺	☺				
RCGT1204M0-PM2	6	0,18 - 0,80	1,0 - 5,0														☺	☺				
RCMT10T3M0T	5	0,12 - 0,80	1,0 - 4,0						☺	☺												
RCMT1204M0T	6	0,12 - 1,00	1,2 - 5,0						☺	☺												
RCMT1605M0T	8	0,15 - 1,10	1,6 - 7,0						☺	☺												
RCMT1606M0T	8	0,15 - 1,10	1,6 - 7,0						☺	☺												
RCMT2006M0T	10	0,20 - 1,20	2,0 - 9,0						☺	☺												
RCMT2507M0T	12,5	0,20 - 1,30	2,5 - 11,0						☺	☺												

For dimensions, see the ISO 1832 designation key from page A-4 onwards.

For achievable surface finish qualities and technical information,
see page A 298 in the Walter General catalogue 2012.

HC = Coated carbide



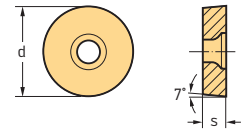

HW = Uncoated carbide

Positive basic shape RCGT/RCMT/RCMX

Tiger-tec® Silver



Indexable inserts

Designation	r mm	f mm	ap mm	P						M			K		N		S			
				HC						HC			HC		HC HW		HC			
				WPP10S	WPP20S	WPP30S	WPP01	WPP10	WPP20	WPP30	WSM10	WSM20	WSM30	WKK20S	WAK10	WAK20	WXN10	WK1	WSM10	WSM20
 RCMT0602M0-PM5	3	0,08 - 0,50	0,6 - 2,5					☺	☺	☺		☺	☺					☺	☺	
RCMT0803M0-PM5	4	0,10 - 0,60	0,8 - 3,0					☺	☺	☺		☺	☺					☺	☺	
RCMT10T3M0-PM5	5	0,12 - 0,80	1,0 - 4,0					☺	☺	☺		☺	☺					☺	☺	
RCMT1204M0-PM5	6	0,12 - 1,00	1,2 - 5,0					☺	☺	☺		☺	☺					☺	☺	
RCMT1605M0-PM5	8	0,15 - 1,20	1,6 - 7,0					☺	☺	☺		☺	☺					☺	☺	
RCMT1606M0-PM5	8	0,15 - 1,20	1,6 - 7,0					☺	☺	☺		☺	☺					☺	☺	
 RCMT10T3M0-HU6	5	0,12 - 0,80	1,0 - 4,0	☹	☹	☹														
RCMT1204M0-HU6	6	0,12 - 1,20	1,2 - 5,0	☹	☹	☹														
RCMT1606M0-HU6	8	0,15 - 1,20	1,6 - 7,0	☹	☹	☹						☹								
 RCMX2006M0-HU6	10	0,25 - 1,40	2,0 - 9,0	☹	☹	☹						☹								
RCMX2507M0-HU6	12,5	0,30 - 1,60	2,5 - 11,0	☹	☹	☹						☹								
RCMX3209M0-HU6	16	0,30 - 1,70	3,2 - 15,0	☹	☹	☹						☹								
 RCMX100300-PR5	5	0,20 - 1,00	1,0 - 4,0																	
RCMX120400-PR5	6	0,20 - 1,20	1,2 - 5,0																	
RCMX160600-PR5	8	0,20 - 1,30	1,6 - 7,0					☺	☺	☺										
RCMX200600-PR5	10	0,25 - 1,40	2,0 - 9,0					☺	☺	☺										
RCMX250700-PR5	12,5	0,30 - 1,60	2,5 - 11,0					☺	☺	☺										
RCMX320900-PR5	16	0,30 - 1,70	3,2 - 15,0					☺	☺	☺										

For dimensions, see the ISO 1832 designation key from page A-4 onwards.

For achievable surface finish qualities and technical information, see page A 298 in the Walter General catalogue 2012.

HC = Coated carbide

HW = Uncoated carbide

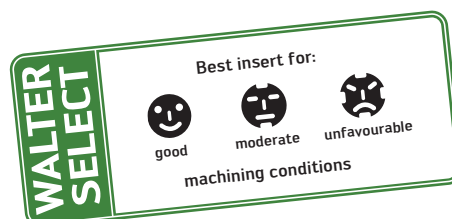

☹ ☹ ☹ New addition to range

Positive basic shape SCGT/SCMT/SCMW

Tiger-tec®

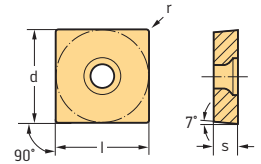

Indexable inserts

Designation	r mm	f mm	ap mm	P				M			K			N		S		
				HC				HC			HC			HC	HW	HC		
				WPP01	WPP10	WPP20	WPP30	WSM10	WSM20	WSM30	WAK10	WAK20	WAK30	WXN10	WK1	WSM10	WSM20	WSM30
	SCGT09T304-PF2	0,4	0,08 - 0,25	0,2 - 2,5					⊕						⊕	⊕	⊕	
	SCGT09T308-PF2	0,8	0,10 - 0,30	0,3 - 3,0					⊕						⊕	⊕	⊕	
	SCGT120408-PF2	0,8	0,10 - 0,30	0,3 - 3,5					⊕						⊕	⊕	⊕	⊕
	SCMT09T304-PF4	0,4	0,05 - 0,15	0,1 - 1,5	⊕	⊕	⊕		⊕	⊕							⊕	⊕
	SCMT09T308-PF4	0,8	0,05 - 0,18	0,1 - 1,8	⊕	⊕	⊕		⊕	⊕							⊕	⊕
	SCMT120404-PF4	0,4	0,05 - 0,15	0,1 - 1,5	⊕	⊕	⊕		⊕	⊕							⊕	⊕
	SCMT120408-PF4	0,8	0,05 - 0,18	0,1 - 1,8	⊕	⊕	⊕		⊕	⊕							⊕	⊕
	SCMT120412-PF4	1,2	0,12 - 0,32	0,3 - 1,8		⊕	⊕											
	SCMT09T304-PS5	0,4	0,08 - 0,25	0,3 - 2,0			⊕		⊕	⊕	⊕	⊕					⊕	⊕
	SCMT09T308-PS5	0,8	0,12 - 0,30	0,5 - 2,0			⊕		⊕	⊕	⊕	⊕					⊕	⊕
	SCMT120408-PS5	0,8	0,12 - 0,32	0,5 - 2,5			⊕		⊕	⊕	⊕	⊕					⊕	⊕
	SCGT09T304-PM2	0,4	0,08 - 0,25	0,6 - 4,0										⊕	⊕			
	SCGT09T308-PM2	0,8	0,10 - 0,35	0,7 - 4,0										⊕	⊕			
	SCGT120408-PM2	0,8	0,10 - 0,40	0,8 - 6,0										⊕	⊕			
	SCMT09T304-PM5	0,4	0,12 - 0,25	0,4 - 3,0	⊕	⊕	⊕		⊕	⊕	⊕	⊕			⊕	⊕	⊕	⊕
	SCMT09T308-PM5	0,8	0,16 - 0,35	0,6 - 4,0	⊕	⊕	⊕		⊕	⊕	⊕	⊕			⊕	⊕	⊕	⊕
	SCMT120404-PM5	0,4	0,12 - 0,25	0,4 - 3,0	⊕	⊕	⊕		⊕	⊕	⊕	⊕			⊕	⊕	⊕	⊕
	SCMT120408-PM5	0,8	0,16 - 0,40	0,6 - 5,0	⊕	⊕	⊕		⊕	⊕	⊕	⊕			⊕	⊕	⊕	⊕
	SCMT120412-PM5	1,2	0,20 - 0,50	0,8 - 5,0	⊕	⊕	⊕		⊕	⊕	⊕	⊕			⊕	⊕	⊕	⊕
	SCMW09T304	0,4	0,12 - 0,25	0,4 - 3,0								⊕	⊕					
	SCMW09T308	0,8	0,16 - 0,35	0,6 - 4,0								⊕	⊕					
	SCMW120404	0,4	0,12 - 0,25	0,4 - 4,0								⊕	⊕					
	SCMW120408	0,8	0,16 - 0,40	0,6 - 5,0								⊕	⊕					
	SCMW120412	1,2	0,16 - 0,40	0,8 - 5,0								⊕	⊕					



For dimensions, see the ISO 1832 designation key from page A-4 onwards.
For achievable surface finish qualities and technical information,
see page A 298 in the Walter General catalogue 2012.

HC = Coated carbide
HW = Uncoated carbide

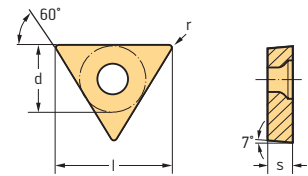
Positive basic shape TCGT/TCMT/TCMW

Tiger-tec®

Indexable inserts

Designation	r mm	f mm	ap mm	P				M			K			N		S			
				HC				HC			HC			HC	HW	HC			
				WPP01	WPP10	WPP20	WPP30	WSM10	WSM20	WSM21	WSM30	WAK10	WAK20	WAK30	WXN10	WK1	WSM10	WSM20	WSM30
 TCGT06T101-PF2	0,1	0,02 - 0,06	0,1 - 1,5							☒					☒	☒			
TCGT06T102-PF2	0,2	0,05 - 0,12	0,2 - 2,0							☒					☒	☒			
TCGT06T104-PF2	0,4	0,08 - 0,25	0,2 - 2,5							☒					☒	☒			
TCGT090201-PF2	0,1	0,02 - 0,06	0,1 - 1,5							☒					☒	☒			☒
TCGT090202-PF2	0,2	0,05 - 0,12	0,2 - 2,0							☒					☒	☒			☒
TCGT090204-PF2	0,4	0,08 - 0,25	0,2 - 2,5							☒					☒	☒			☒
TCGT110201-PF2	0,1	0,02 - 0,06	0,1 - 1,5							☒					☒	☒			☒
TCGT110202-PF2	0,2	0,05 - 0,12	0,2 - 2,0							☒					☒	☒			☒
TCGT110204-PF2	0,4	0,08 - 0,25	0,2 - 2,5							☒					☒	☒			☒
TCGT16T301-PF2	0,1	0,02 - 0,06	0,1 - 1,5							☒					☒	☒			☒
TCGT16T302-PF2	0,2	0,05 - 0,12	0,2 - 2,0							☒					☒	☒			☒
TCGT16T304-PF2	0,4	0,08 - 0,25	0,2 - 2,5							☒					☒	☒			☒
TCGT16T308-PF2	0,8	0,10 - 0,30	0,3 - 3,0							☒					☒	☒			☒
 TCMT06T102-PF4	0,2	0,02 - 0,10	0,1 - 1,0			☒				☒									
TCMT06T104-PF4	0,4	0,04 - 0,17	0,1 - 1,0			☒				☒									
TCMT090202-PF4	0,2	0,04 - 0,12	0,1 - 1,0	☒	☒	☒		☒	☒	☒							☒	☒	☒
TCMT090204-PF4	0,4	0,05 - 0,16	0,1 - 1,5	☒	☒	☒		☒	☒	☒							☒	☒	☒
TCMT090208-PF4	0,8	0,08 - 0,20	0,1 - 2,5	☒	☒	☒		☒	☒	☒							☒	☒	☒
TCMT110202-PF4	0,2	0,04 - 0,12	0,1 - 1,0	☒	☒	☒		☒	☒	☒							☒	☒	☒
TCMT110204-PF4	0,4	0,05 - 0,16	0,1 - 1,5	☒	☒	☒		☒	☒	☒							☒	☒	☒
TCMT110208-PF4	0,8	0,08 - 0,20	0,1 - 2,5	☒	☒	☒		☒	☒	☒							☒	☒	☒
TCMT16T302-PF4	0,2	0,04 - 0,12	0,1 - 1,0	☒	☒	☒				☒								☒	☒
TCMT16T304-PF4	0,4	0,05 - 0,16	0,1 - 1,5	☒	☒	☒		☒	☒	☒							☒	☒	☒
TCMT16T308-PF4	0,8	0,08 - 0,20	0,1 - 2,5	☒	☒	☒		☒	☒	☒							☒	☒	☒
 TCMT110204-PS5	0,4	0,08 - 0,25	0,3 - 1,6			☒				☒	☒							☒	☒
TCMT110208-PS5	0,8	0,12 - 0,30	0,5 - 1,6			☒				☒	☒							☒	☒
TCMT16T304-PS5	0,4	0,08 - 0,25	0,3 - 2,0			☒				☒	☒							☒	☒
TCMT16T308-PS5	0,8	0,12 - 0,32	0,5 - 2,5			☒				☒	☒							☒	☒

For dimensions, see the ISO 1832 designation key from page A-4 onwards.
For achievable surface finish qualities and technical information, see page A 298 in the Walter General catalogue 2012.



HC = Coated carbide
HW = Uncoated carbide

Positive basic shape TCGT/TCMT/TCMW

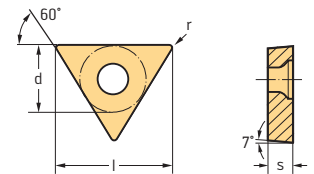
Tiger-tec®



Indexable inserts

Designation	r mm	f mm	ap mm	P				M			K		N		S			
				HC				HC			HC		HC	HW	HC			
				WPP01	WPP10	WPP20	WPP30	WSM10	WSM20	WSM21	WSM30	WAK10	WAK20	WAK30	WXN10	WK1	WSM10	WSM20
 TCGT110201-PM2	0,1	0,02 - 0,06	0,5 - 1,5											☺	☺			
TCGT110202-PM2	0,2	0,05 - 0,12	0,6 - 2,0											☺	☺			
TCGT110204-PM2	0,4	0,08 - 0,25	0,6 - 3,0											☺	☺			
TCGT16T302-PM2	0,2	0,05 - 0,12	0,5 - 2,0											☺	☺			
TCGT16T304-PM2	0,4	0,08 - 0,25	0,6 - 4,0											☺	☺			
TCGT16T308-PM2	0,8	0,10 - 0,35	0,8 - 4,0											☺	☺			
 TCMT090204-PM5	0,4	0,12 - 0,25	0,4 - 3,0	☺	☺	☺	☺	☺		☺	☺	☺	☺			☺	☺	☺
TCMT090208-PM5	0,8	0,16 - 0,30	0,6 - 3,0	☺	☺	☺	☺	☺		☺	☺	☺	☺			☺	☺	☺
TCMT110204-PM5	0,4	0,12 - 0,25	0,4 - 3,0	☺	☺	☺	☺	☺		☺	☺	☺	☺			☺	☺	☺
TCMT110208-PM5	0,8	0,16 - 0,30	0,6 - 3,0	☺	☺	☺	☺	☺		☺	☺	☺	☺			☺	☺	☺
TCMT16T304-PM5	0,4	0,12 - 0,25	0,4 - 3,0	☺	☺	☺	☺	☺		☺	☺	☺	☺			☺	☺	☺
TCMT16T308-PM5	0,8	0,16 - 0,30	0,6 - 4,0	☺	☺	☺	☺	☺		☺	☺	☺	☺			☺	☺	☺
TCMT16T312-PM5	1,2	0,20 - 0,40	0,8 - 4,0	☺	☺	☺	☺	☺		☺	☺	☺	☺			☺	☺	☺
 TCMW110202	0,2	0,08 - 0,12	0,2 - 3,0							☺	☺							
TCMW110204	0,4	0,12 - 0,25	0,4 - 3,0							☺	☺							
TCMW110208	0,8	0,16 - 0,30	0,6 - 3,0							☺	☺							
TCMW16T304	0,4	0,12 - 0,25	0,4 - 3,0							☺	☺							
TCMW16T308	0,8	0,16 - 0,30	0,6 - 4,0							☺	☺							
TCMW16T312	1,2	0,20 - 0,40	0,8 - 4,0							☺	☺							

For dimensions, see the ISO 1832 designation key from page A-4 onwards.
For achievable surface finish qualities and technical information, see page A 298 in the Walter General catalogue 2012.

HC = Coated carbide
HW = Uncoated carbide

WALTER SELECT

Best insert for:

☺
good

☹
moderate



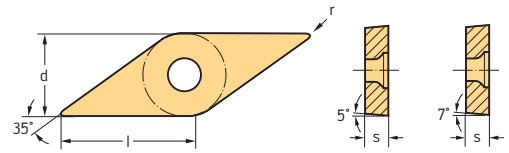

☹
unfavourable

machining conditions

Positive basic shape VBGT/VBMT/VCGT/VCMT/VCMW

Tiger-tec®

Indexable inserts

Designation	r mm	f mm	ap mm	P				M			K		N		S		
				HC				HC			HC	HC	HW	HC			
				WPP01	WPP10	WPP20	WPP30	WSM10	WSM20	WSM30	WAK10	WAK20	WXN10	WK1	WSM10	WSM20	WSM30
 VCGT110301-PF2	0,1	0,02 - 0,06	0,1 - 1,5														
VCGT110302-PF2	0,2	0,05 - 0,12	0,2 - 2,0														
VCGT110304-PF2	0,4	0,08 - 0,25	0,2 - 2,5														
VCGT160402-PF2	0,2	0,05 - 0,12	0,2 - 2,0														
VCGT160404-PF2	0,4	0,08 - 0,25	0,2 - 2,5														
VCGT160408-PF2	0,8	0,10 - 0,30	0,3 - 3,0														
 VCMT110302-PF4	0,2	0,04 - 0,12	0,1 - 1,0														
VCMT110304-PF4	0,4	0,05 - 0,16	0,1 - 1,5														
VCMT160402-PF4	0,2	0,04 - 0,12	0,1 - 1,0														
VCMT160404-PF4	0,4	0,05 - 0,16	0,1 - 1,5														
VCMT160408-PF4	0,8	0,08 - 0,20	0,1 - 2,5														
 VBGT110302-PF5	0,2	0,04 - 0,10	0,1 - 0,6														
VBGT110304-PF5	0,4	0,06 - 0,12	0,2 - 0,6														
 VBMT110304-PS5	0,4	0,08 - 0,20	0,3 - 1,6														
VBMT110308-PS5	0,8	0,12 - 0,30	0,5 - 1,6														
VBMT160404-PS5	0,4	0,08 - 0,25	0,3 - 2,0														
VBMT160406-PS5	0,6	0,12 - 0,30	0,4 - 2,0														
VBMT160408-PS5	0,8	0,12 - 0,30	0,6 - 2,5														
VBMT160412-PS5	1,2	0,15 - 0,30	1,0 - 2,5														
 VCGT110301-PM2	0,1	0,02 - 0,06	0,5 - 1,5														
VCGT110302-PM2	0,2	0,05 - 0,12	0,5 - 2,0														
VCGT110304-PM2	0,4	0,08 - 0,25	0,6 - 2,5														
VCGT110308-PM2	0,8	0,10 - 0,35	0,8 - 3,0														
VCGT130301-PM2	0,1	0,02 - 0,06	0,5 - 1,5														
VCGT130302-PM2	0,2	0,05 - 0,12	0,5 - 2,0														
VCGT130304-PM2	0,4	0,08 - 0,25	0,6 - 3,0														
VCGT160404-PM2	0,4	0,08 - 0,25	0,6 - 3,5														
VCGT160408-PM2	0,8	0,10 - 0,35	0,8 - 3,5														
VCGT160412-PM2	1,2	0,10 - 0,45	1,0 - 3,5														

For dimensions, see the ISO 1832 designation key from page A-4 onwards.

For achievable surface finish qualities and technical information, see page A 298 in the Walter General catalogue 2012.



 HC = Coated carbide
 HW = Uncoated carbide

Positive basic shape VBGT/VBMT/VCGT/VCMT/VCMW

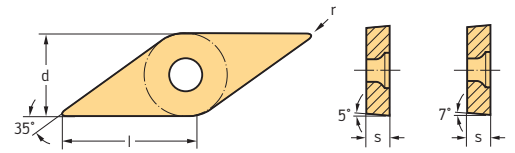
Tiger-tec®



Indexable inserts

Designation	r mm	f mm	ap mm	P				M			K		N		S		
				HC				HC			HC		HC	HW	HC		
				WPP01	WPP10	WPP20	WPP30	WSM10	WSM20	WSM30	WAK10	WAK20	WXN10	WK1	WSM10	WSM20	WSM30
 VCMT110304-PM5	0,4	0,12 - 0,20	0,4 - 2,5	☺	☺	☺	☺	☺	☺	☺	☺			☺	☺	☺	
VCMT110308-PM5	0,8	0,16 - 0,25	0,6 - 3,0	☺	☺	☺	☺	☺	☺	☺	☺			☺	☺	☺	
VCMT160404-PM5	0,4	0,12 - 0,25	0,4 - 2,5	☺	☺	☺	☺	☺	☺	☺	☺			☺	☺	☺	
VCMT160406-PM5	0,6	0,15 - 0,25	0,6 - 3,0	☺	☺	☺	☺	☺	☺	☺	☺			☺	☺	☺	
VCMT160408-PM5	0,8	0,16 - 0,30	0,6 - 3,0	☺	☺	☺	☺	☺	☺	☺	☺			☺	☺	☺	
VCMT160412-PM5	1,2	0,20 - 0,35	0,8 - 4,0	☺	☺	☺	☺	☺	☺	☺	☺			☺	☺	☺	
 VCMW160404	0,4	0,12 - 0,25	0,4 - 2,5							☺	☺						
VCMW160408	0,8	0,16 - 0,30	0,6 - 3,0							☺	☺						
VCMW160412	1,2	0,20 - 0,25	0,8 - 4,0							☺	☺						

For dimensions, see the ISO 1832 designation key from page A-4 onwards.
For achievable surface finish qualities and technical information, see page A 298 in the Walter General catalogue 2012.

HC = Coated carbide
HW = Uncoated carbide

WALTER SELECT

Best insert for:

☺
good

☹
moderate

☹
unfavourable



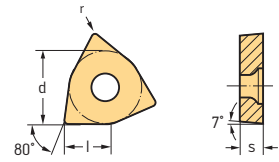

machining conditions

Positive basic shape WCGT/WCMT

Tiger-tec®



Indexable inserts

Designation	r mm	f mm	ap mm	P				M			K		N		S		
				HC				HC			HC	HC	HW	HC			
				WPP01	WPP10	WPP20	WPP30	WSM10	WSM20	WSM21	WSM30	WAK10	WAK20	WXN10	WK1	WSM10	WSM20
 Wiper	WCMT040204-PF	0,4	0,05 - 0,30	0,3 - 1,5	☒	☒	☒		☒							☒	
	WCMT040208-PF	0,8	0,05 - 0,30	0,3 - 1,5	☒	☒	☒		☒							☒	
	WCMT06T304-PF	0,4	0,07 - 0,30	0,3 - 2,0	☒	☒	☒		☒							☒	
	WCMT06T308-PF	0,8	0,07 - 0,35	0,3 - 2,0	☒	☒	☒		☒							☒	
	WCGT030201-PF2	0,1	0,02 - 0,06	0,1 - 1,5								☒	☒				
	WCGT030202-PF2	0,2	0,05 - 0,12	0,2 - 2,0					☒			☒	☒				
	WCGT030204-PF2	0,4	0,08 - 0,25	0,2 - 2,5					☒			☒	☒				
	WCGT040201-PF2	0,1	0,02 - 0,06	0,1 - 1,5								☒	☒				
	WCGT040202-PF2	0,2	0,05 - 0,12	0,2 - 2,0					☒			☒	☒				
	WCGT040204-PF2	0,4	0,08 - 0,25	0,2 - 2,5					☒			☒	☒				
	WCGT06T301-PF2	0,1	0,02 - 0,06	0,1 - 1,5								☒	☒				
	WCGT06T302-PF2	0,2	0,05 - 0,12	0,2 - 2,0								☒	☒				
	WCGT06T304-PF2	0,4	0,08 - 0,25	0,2 - 2,5								☒	☒				
	WCGT06T308-PF2	0,8	0,10 - 0,30	0,3 - 3,0								☒	☒				
	WCMT040202-PF4	0,2	0,04 - 0,12	0,1 - 1,0	☒	☒			☒	☒					☒	☒	
	WCMT040204-PF4	0,4	0,05 - 0,16	0,1 - 1,5	☒	☒			☒	☒					☒	☒	
	WCMT040208-PF4	0,8	0,08 - 0,20	0,1 - 2,5	☒	☒			☒	☒					☒	☒	
	WCMT06T302-PF4	0,2	0,04 - 0,12	0,1 - 1,0	☒	☒			☒	☒					☒	☒	
	WCMT06T304-PF4	0,4	0,05 - 0,16	0,1 - 1,5	☒	☒			☒	☒					☒	☒	
	WCMT06T308-PF4	0,8	0,08 - 0,20	0,1 - 2,5	☒	☒			☒	☒					☒	☒	
	WCMT080404-PF4	0,4	0,05 - 0,16	0,1 - 1,5	☒	☒			☒	☒					☒	☒	
	WCMT080408-PF4	0,8	0,08 - 0,20	0,1 - 2,5	☒	☒			☒	☒					☒	☒	
	WCMT040204-PS5	0,4	0,08 - 0,25	0,3 - 1,6		☒					☒	☒					
	WCMT040208-PS5	0,8	0,12 - 0,30	0,5 - 1,6		☒					☒	☒					
	WCMT06T304-PS5	0,4	0,08 - 0,25	0,3 - 2,0		☒					☒	☒					
	WCMT06T308-PS5	0,8	0,12 - 0,32	0,5 - 2,0		☒					☒	☒					
	WCMT080404-PS5	0,4	0,08 - 0,25	0,3 - 2,5		☒					☒	☒					
	WCMT080408-PS5	0,8	0,12 - 0,32	0,5 - 2,5		☒					☒	☒					

For dimensions, see the ISO 1832 designation key from page A-4 onwards.
For achievable surface finish qualities and technical information, see page A 298 in the Walter General catalogue 2012.



HC = Coated carbide
HW = Uncoated carbide

Positive basic shape WCGT/WCMT

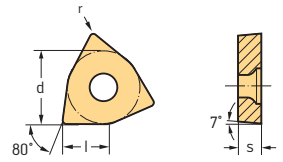
Tiger-tec®



Indexable inserts

Designation	r mm	f mm	ap mm	P				M			K		N		S		
				HC				HC			HC	HC	HW	HC			
				WPP01	WPP10	WPP20	WPP30	WSM10	WSM20	WSM21	WSM30	WAK10	WAK20	WXN10	WK1	WSM10	WSM20
 WCGT06T304-PM WCGT06T308-PM	0,4	0,12 - 0,35	0,5 - 2,5	☺	☺					☺	☺						
	0,8	0,12 - 0,35	0,5 - 2,5	☺	☺					☺	☺						
 WCGT030202-PM2 WCGT030204-PM2 WCGT040202-PM2 WCGT040204-PM2 WCGT06T302-PM2 WCGT06T304-PM2 WCGT080404-PM2 WCGT080408-PM2	0,2	0,05 - 0,12	0,5 - 1,5									☺	☺				
	0,4	0,08 - 0,20	0,6 - 1,5									☺	☺				
	0,2	0,05 - 0,12	0,5 - 2,0									☺	☺				
	0,4	0,08 - 0,25	0,6 - 2,5									☺	☺				
	0,2	0,05 - 0,12	0,6 - 2,0									☺	☺				
	0,4	0,08 - 0,25	0,6 - 3,0									☺	☺				
	0,4	0,08 - 0,25	0,6 - 4,0									☺	☺				
	0,8	0,10 - 0,35	0,8 - 4,0									☺	☺				
 WCMT030202-PM5 WCMT040202-PM5 WCMT040204-PM5 WCMT06T304-PM5 WCMT06T308-PM5 WCMT080404-PM5 WCMT080408-PM5 WCMT080412-PM5	0,2	0,08 - 0,12	0,2 - 1,5	☺	☺	☺		☺	☺	☺				☺	☺		
	0,2	0,08 - 0,12	0,4 - 2,0	☺	☺	☺		☺	☺	☺				☺	☺		
	0,4	0,12 - 0,25	0,4 - 2,5	☺	☺	☺		☺	☺	☺				☺	☺		
	0,4	0,12 - 0,25	0,4 - 3,0	☺	☺	☺		☺	☺	☺				☺	☺		
	0,8	0,16 - 0,35	0,6 - 4,0	☺	☺	☺		☺	☺	☺				☺	☺		
	0,4	0,12 - 0,25	0,4 - 3,0	☺	☺	☺		☺	☺	☺				☺	☺		
	0,8	0,16 - 0,40	0,6 - 4,0	☺	☺	☺		☺	☺	☺				☺	☺		
	1,2	0,20 - 0,55	0,8 - 5,0	☺	☺	☺		☺	☺	☺				☺	☺		

For dimensions, see the ISO 1832 designation key from page A-4 onwards.
 For achievable surface finish qualities and technical information,
 see page A 298 in the Walter General catalogue 2012.

HC = Coated carbide
 HW = Uncoated carbide

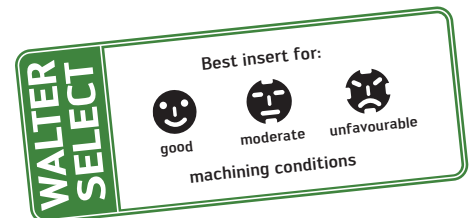



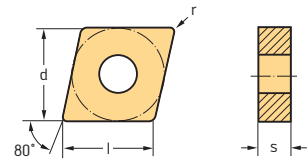

Negative basic shape CNGN/CNMA

Ceramic and CBN



Indexable inserts

Designation	l mm	r mm	f mm	ap mm	K		S		H	
					CN	CR	CN	CR	BL	BH
					WSN10	WIS10	WWS20	WCB30	WCB50	
 CNGN120708T01020 CNGN120712T01020 CNGN120716T01020	12,9	0,8	0,10 - 0,22	0,1 - 3,6			☺	☺		
	12,9	1,2	0,10 - 0,32	0,1 - 3,6			☺	☺		
	12,9	1,6	0,10 - 0,42	0,1 - 3,6			☺	☺		
 CNMA120408T02020 CNMA120412T02020 CNMA120416T02020	12,9	0,8	0,10 - 0,36	0,1 - 6,0	☺					
	12,9	1,2	0,10 - 0,54	0,1 - 6,0	☺					
	12,9	1,6	0,10 - 0,60	0,1 - 6,0	☺					
 CNMA120404 CNMA120408 CNMA120412	12,9	0,4	0,05 - 0,20	0,1 - 2,5					☺	☺
	12,9	0,8	0,05 - 0,25	0,1 - 2,4					☺	☺
	12,9	1,2	0,05 - 0,30	0,1 - 2,3					☺	☺
 CNMA120404-2 CNMA120408-2 CNMA120412-2	12,9	0,4	0,05 - 0,20	0,1 - 2,5					☺	☺
	12,9	0,8	0,05 - 0,25	0,1 - 2,4					☺	☺
	12,9	1,2	0,05 - 0,30	0,1 - 2,3					☺	☺

For dimensions, see the ISO 1832 designation key from page A-4 onwards.
For achievable surface finish qualities and technical information, see page A 299 in the Walter General catalogue 2012.

CN = Silicon nitride Si_3N_4
CR = Reinforced ceramic
BL = CBN with low CBN content
BH = CBN with high CBN content

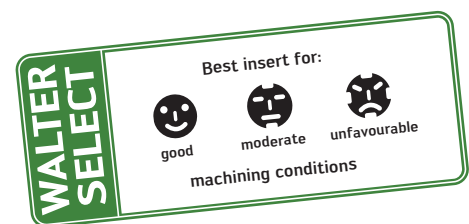

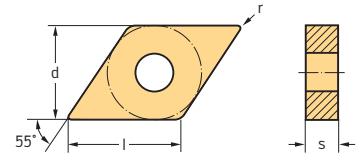

Negative basic shape DNGN/DNMA

Ceramic and CBN

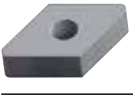

Indexable inserts

Designation	l mm	r mm	f mm	ap mm	K		S		H	
					CN	CR	BL	BH		
					WSN10	WIS10	WWS20	WCB30	WCB50	
 DNGN150708T01020 DNGN150712T01020	15,5	0,8	0,10 - 0,20	0,1 - 2,5						
	15,5	1,2	0,10 - 0,32	0,1 - 2,5						
 DNMA150608T02020 DNMA150612T02020	15,5	0,8	0,10 - 0,36	0,1 - 7,5						
	15,5	1,2	0,10 - 0,54	0,1 - 7,5						
 DNMA150604-2 DNMA150608-2 DNMA150612-2	15,5	0,4	0,05 - 0,20	0,1 - 2,5						
	15,5	0,8	0,05 - 0,25	0,1 - 2,1						
	15,5	1,2	0,05 - 0,30	0,1 - 2,1						

Negative basic shape RNGN

Ceramic and CBN

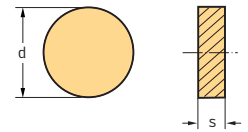

Indexable inserts

Designation	d mm	f mm	ap mm	S		H	
				CN	CR	BL	BH
				WIS10	WWS20	WCB30	WCB50
 RNGN120700E RNGN120700T01020 RNGN150700T01020 RNGN190700T01020 RNGN250700E	12,7	0,10 - 0,32	0,1 - 3,6				
	12,7	0,20 - 0,32	0,2 - 3,6				
	15,875	0,10 - 0,40	0,2 - 4,5				
	19,05	0,10 - 0,45	0,2 - 5,7				
	25,4	0,10 - 0,50	0,2 - 7,5				

For dimensions, see the ISO 1832 designation key from page A-4 onwards.
For achievable surface finish qualities and technical information,
see page A 299 in the Walter General catalogue 2012.



CN = Silicon nitride Si_3N_4
CR = Reinforced ceramic
BL = CBN with low CBN content
BH = CBN with high CBN content

Negative basic shape SNGN/SNMA

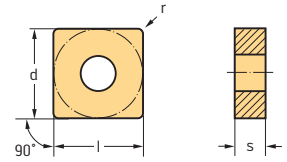
Ceramic and CBN



Indexable inserts



Designation	l mm	r mm	f mm	ap mm	K		S		H	
					CN	CN	CR	BL	BH	
					WSN10	WIS10	WWS20	WCB30	WCB50	
 SNGN120708T01020 SNGN120712E SNGN120712T01020 SNGN120716T01020	12,7	0,8	0,10 - 0,22	0,1 - 3,6						
	12,7	1,2	0,10 - 0,32	0,1 - 3,6						
	12,7	1,2	0,10 - 0,32	0,1 - 3,6						
	12,7	1,6	0,10 - 0,42	0,1 - 3,6						
 SNMA120408T02020 SNMA120412T02020 SNMA120416T02020	12,7	0,8	0,10 - 0,36	0,1 - 6,0						
	12,7	1,2	0,10 - 0,54	0,1 - 6,0						
	12,7	1,6	0,10 - 0,60	0,1 - 6,0						
 SNMA120408 SNMA120412	12,7	0,8	0,05 - 0,25	0,1 - 2,3						
	12,7	1,2	0,05 - 0,30	0,1 - 2,1						

Negative basic shape TNMA

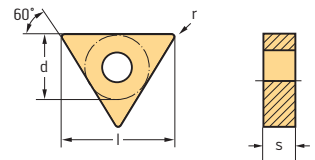
Ceramic and CBN







Indexable inserts

Designation	l mm	r mm	f mm	ap mm	K		S		H	
					CN	CN	CR	BL	BH	
					WSN10	WIS10	WWS20	WCB30	WCB50	
 TNMA160408T02020 TNMA160412T02020	16,5	0,8	0,05 - 0,36	0,1 - 8,0						
	16,5	1,2	0,10 - 0,54	0,1 - 8,0						
 TNMA160404-3 TNMA160408-3 TNMA160412-3	16,5	0,4	0,05 - 0,20	0,1 - 2,3						
	16,5	0,8	0,05 - 0,25	0,1 - 2,0						
	16,5	1,2	0,05 - 0,30	0,1 - 2,0						

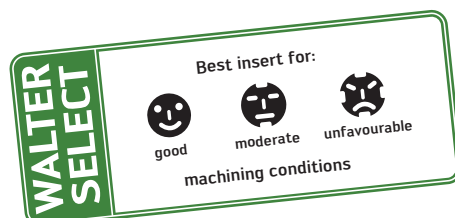
For dimensions, see the ISO 1832 designation key from page A-4 onwards.
For achievable surface finish qualities and technical information, see page A 299 in the Walter General catalogue 2012.

CN = Silicon nitride Si_3N_4
CR = Reinforced ceramic
BL = CBN with low CBN content
BH = CBN with high CBN content





   New addition to range

Positive basic shape CCMW

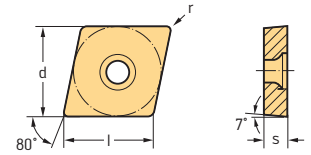
Ceramic and CBN



Indexable inserts



Designation	l mm	r mm	f mm	ap mm	S		H		
					CN	CR	BL	BH	
					WIS10	WWS20	WCB30	WCB50	
	CCMW060204	6,45	0,4	0,05 - 0,20	0,1 - 2,5			☺	☹
	CCMW060208	6,45	0,8	0,05 - 0,25	0,1 - 2,4			☺	☹
	CCMW09T304	9,67	0,4	0,05 - 0,20	0,1 - 2,4			☺	☹
	CCMW09T308	9,67	0,8	0,05 - 0,25	0,1 - 2,3			☺	☹
	CCMW060204-2	6,45	0,4	0,05 - 0,20	0,1 - 2,5			☺	☹
	CCMW060208-2	6,45	0,8	0,05 - 0,25	0,1 - 2,4			☺	☹
	CCMW09T304-2	9,67	0,4	0,05 - 0,20	0,1 - 2,4			☺	☹
	CCMW09T308-2	9,67	0,8	0,05 - 0,25	0,1 - 2,3			☺	☹

Positive basic shape DCMW

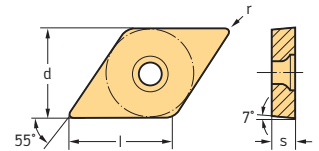
Ceramic and CBN

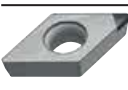

Indexable inserts

Designation	l mm	r mm	f mm	ap mm	S		H		
					CN	CR	BL	BH	
					WIS10	WWS20	WCB30	WCB50	
	DCMW11T302	11,63	0,2	0,05 - 0,15	0,1 - 2,6			☺	☹
	DCMW11T304	11,63	0,4	0,05 - 0,20	0,1 - 2,5			☺	☹
	DCMW11T308	11,63	0,8	0,05 - 0,25	0,1 - 2,1			☺	☹
	DCMW11T304-2	11,63	0,4	0,05 - 0,20	0,1 - 2,5			☺	☹
	DCMW11T308-2	11,63	0,8	0,05 - 0,25	0,1 - 2,1			☺	☹

For dimensions, see the ISO 1832 designation key from page A-4 onwards.
For achievable surface finish qualities and technical information,
see page A 299 in the Walter General catalogue 2012.



CN = Silicon nitride Si_3N_4
CR = Reinforced ceramic
BL = CBN with low CBN content
BH = CBN with high CBN content

Positive basic shape RCGX/RPGX

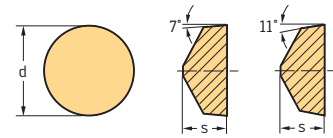
Ceramic and CBN



Indexable inserts

Designation	d mm	f mm	ap mm	S		H	
				CN	CR	BL	BH
				WIS10	WWS20	WCB30	WCB50
 RCGX060600T01020 RCGX090700E RCGX090700T01020 RCGX120700E RCGX120700T01020	6,35	0,10 - 0,20	0,2 - 1,8	☺	☹		
	9,525	0,10 - 0,25	0,1 - 2,4	☺			
	9,525	0,10 - 0,25	0,2 - 2,4	☺	☹		
	12,7	0,10 - 0,32	0,1 - 3,6	☺	☹		
	12,7	0,10 - 0,32	0,2 - 3,6	☺	☹		
 RPGX090700E RPGX090700T01020 RPGX120700E RPGX120700T01020	9,525	0,10 - 0,20	0,1 - 2,4	☺			
	9,525	0,10 - 0,20	0,2 - 2,4	☺			
	12,7	0,10 - 0,30	0,1 - 3,6	☺			
	12,7	0,10 - 0,30	0,2 - 3,6	☺	☹		

Positive basic shape TCMW

Ceramic and CBN

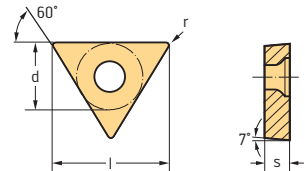

Indexable inserts

Designation	l mm	r mm	f mm	ap mm	S		H	
					CN	CR	BL	BH
					WIS10	WWS20	WCB30	WCB50
 TCMW110204 TCMW110208	11	0,4	0,05 - 0,20			☺	☹	
	11	0,8	0,05 - 0,25			☺	☹	

For dimensions, see the ISO 1832 designation key from page A-4 onwards.
For achievable surface finish qualities and technical information,
see page A 299 in the Walter General catalogue 2012.

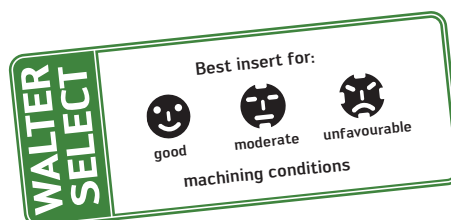

CN = Silicon nitride Si_3N_4
CR = Reinforced ceramic
BL = CBN with low CBN content
BH = CBN with high CBN content

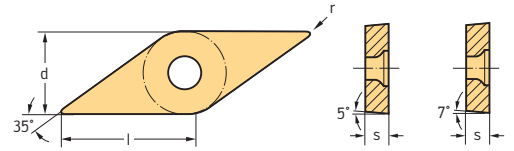

Positive basic shape VBMW Ceramic and CBN



Indexable inserts

Designation	l mm	r mm	f mm	ap mm	S		H		
					CN	CR	BL	BH	
					WIS10	WWS20	WCB30	WCB50	
 VBMW160402	16,6	0,2	0,05 - 0,15	0,1 - 3,8			⊕	⊕	
	VBMW160404	16,6	0,4	0,05 - 0,20	0,1 - 3,3			⊕	⊕
	VBMW160408	16,6	0,8	0,05 - 0,25	0,1 - 2,5			⊕	⊕
 VBMW160404-2	16,6	0,4	0,05 - 0,20	0,1 - 3,3			⊕	⊕	
	VBMW160408-2	16,6	0,8	0,05 - 0,25	0,1 - 2,5			⊕	⊕

For dimensions, see the ISO 1832 designation key from page A-4 onwards.
For achievable surface finish qualities and technical information, see page A 299 in the Walter General catalogue 2012.

CN = Silicon nitride Si_3N_4
CR = Reinforced ceramic
BL = CBN with low CBN content
BH = CBN with high CBN content

Designation key for cutting inserts

Example

GX 24		- 2 E 300 N 03 -					U F 4		
1	2	3	4	5	6	7	8	9	10

1	
Insert type	
GX	
LX	
FX	
SX	

2	
Insert length (l) [mm]	
09	l = 9
16	l = 16
24	l = 24
30	l = 30

3	
Width category	
0	
1	
2	
3	
4	
5	

4	
Basic shape	
E	
F	
R	
S	

8	
Application	
C	"Cut off" - Parting off - Radial grooving
G	"Grooving" - Radial grooving - Axial grooving - Parting off
R	Full radius - Radial grooving - Axial grooving - Longitudinal turning - Facing
U	Universal - Longitudinal turning - Radial grooving - Axial grooving - Facing - Parting off

5

Groove width s [mm]

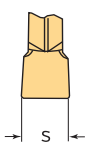





for example:

200	s = 2,0
220	s = 2,2
250	s = 2,5
300	s = 3,0
310	s = 3,1
etc.	

6

Version

Grooving:	R		right-hand
	L		left-hand
	N		neutral
Parting off:	R		right-hand
	L		left-hand

7



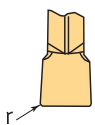
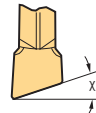

**Corner radius r [mm]/
clearance angle χ [°]**

	02	r = 0,2
	03	r = 0,3
	04	r = 0,4
	05	r = 0,5
etc.		
	6	$\chi = 6^\circ$
	7	$\chi = 7^\circ$
	15	$\chi = 15^\circ$
etc.		

9

Rake angle

smaller





		A
		D
		F
		K

larger

10

Cutting edge

stable

	1
	3
	4
	6
	8

sharp

Walter Select for parting off inserts

Step by step to the right cutting insert

STEP 1

Determine the **material** to be machined from page H 8 in the Walter General catalogue 2012.

Note the machining group that corresponds to your material e.g.: P10.

Code letter	Machining group	Groups of the materials to be machined	
P	P1–P15	Steel	All types of steel and cast steel, with the exception of steel with an austenitic structure
M	M1–M3	Stainless steel	Stainless austenitic steel, austenitic-ferritic steel and cast steel
K	K1–K7	Cast iron	Grey cast iron, cast iron with spheroidal graphite, malleable cast iron, cast iron with vermicular graphite
N	N1–N10	NF metals	Aluminium and other non-ferrous metals, non-ferrous materials
S	S1–S10	High temperature alloys and titanium alloys	Heat resisting special alloys based on iron, nickel and cobalt, titanium and titanium alloys
H	H1–H4	Hard materials	Hardened steel, hardened cast iron materials, chilled cast iron
O	O1–O6	Other	Plastics, fibre glass and carbon fibre reinforced plastics, graphite

STEP 2

Determine the **basic shape** of the cutting insert:

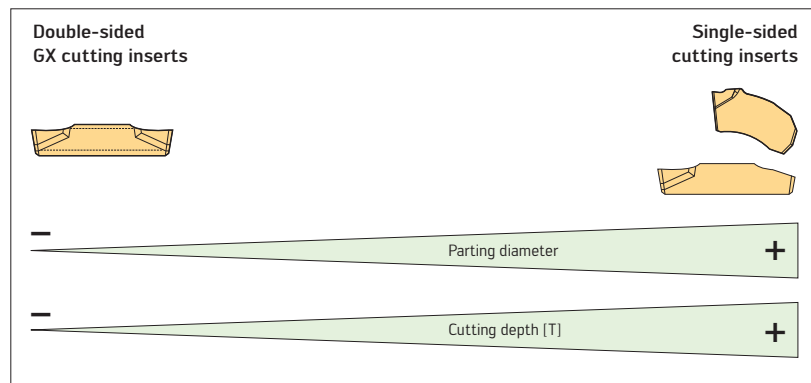

STEP 3

Select the **machining conditions**:

Type of workpiece	Machine stability, clamping system and workpiece		
	very good	good	moderate
Smooth cut Parting into a bore	☺	☹	☹
Smooth cut Parting to centre	☹	☹	☹
Interrupted cuts	☹	☹	☹

STEP 4

Determine the **indexable insert geometry** via the cutting edge stability and the feed.



Geometry selection for cutting inserts for parting off

GX cutting inserts

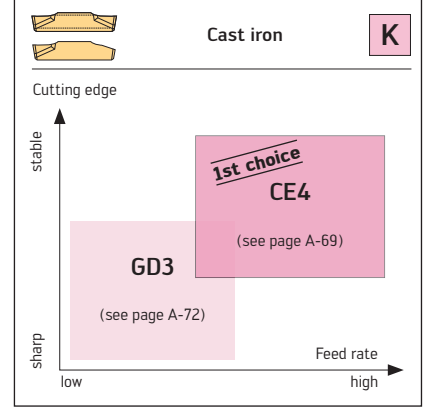
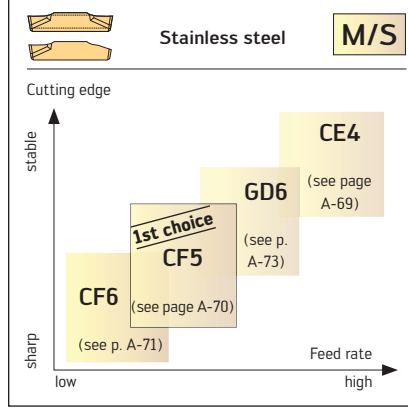
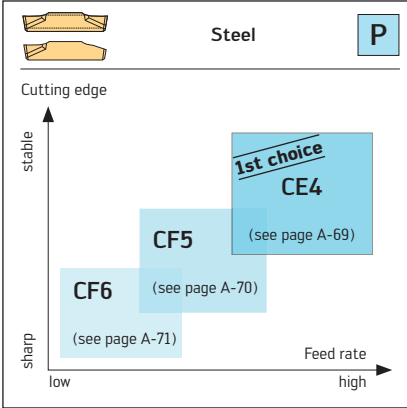

SX cutting inserts

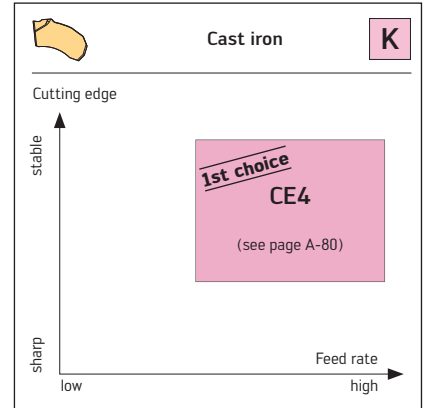
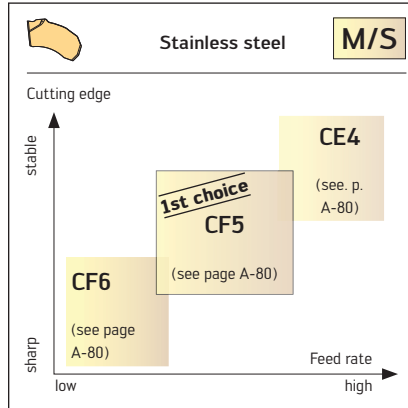
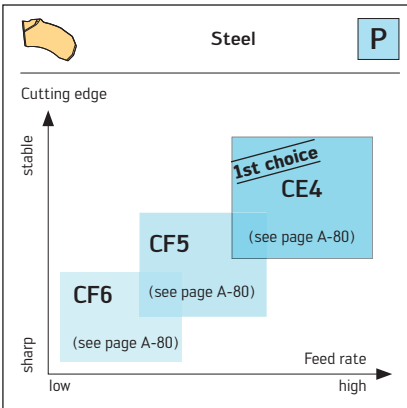

Geometry selection for FX cutting inserts, see page A 55 in the Walter General catalogue 2012.

STEP 5

You will find the cutting tool material recommendation and the feed value (f) on the specified catalogue page.

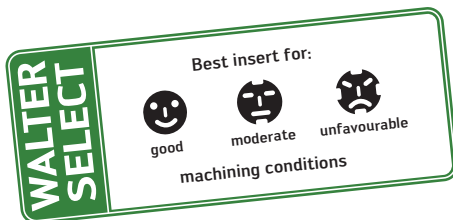

Walter Cut GX grooving inserts
Grooving and parting off
Tiger-tec® Silver

Designation	s mm	r mm	κ	l mm	f mm	s _{Tol} mm	l _{Tol} mm	P		M		K		S	
								WC	HC	WC	HC	WC	HC	WC	HC
GX16-1E200N02-CF5	2	0,2		16,6	0,04 - 0,12	±0,05	±0,15	•	•	•	•	•	•	•	•
GX16-1E200R/L6-CF5	2	0,2	6°	16,6	0,03 - 0,10	±0,05	±0,15	•	•	•	•	•	•	•	•
GX16-1E200R/L7-CF5	2		7°	16,2	0,03 - 0,10	±0,05	±0,15	•	•	•	•	•	•	•	•

Cutting data for Walter Cut – Parting off Carbide grades

= Cutting data for wet machining
 = Dry machining is possible

Material group	Structure of main material groups and identification letters	Temperatures	Tensile hardness HB	Tensile strength R _m N/mm ²	Machining group ¹	Machining group ²
Unalloyed steel	C < 0,25%	annealed	125	426	P1	•
	C > 0,25% < 0,55%	annealed	190	639	P2	•
	C > 0,25% < 0,55%	tempered	210	708	P3	•
	C > 0,55%	annealed	190	639	P4	•
	C > 0,55%	tempered	300	1013	P5	•
	Free cutting steel (short-chipping)	annealed	220	745	P6	•
P Low-alloyed steel	annealed	175	591	P7	•	
	tempered	300	1013	P8	•	

STEP 6

Choose the **cutting data** for your selected cutting insert from the technical information from page A-142 onwards.

Walter Select for grooving and recessing inserts

Step by step to the right cutting insert

STEP 1

Determine the **material** to be machined from page H 8 in the Walter General catalogue 2012.

Note the machining group that corresponds to your material e.g.: P10.

Code letter	Machining group	Groups of the materials to be machined	
P	P1–P15	Steel	All types of steel and cast steel, with the exception of steel with an austenitic structure
M	M1–M3	Stainless steel	Stainless austenitic steel, austenitic-ferritic steel and cast steel
K	K1–K7	Cast iron	Grey cast iron, cast iron with spheroidal graphite, malleable cast iron, cast iron with vermicular graphite
N	N1–N10	NF metals	Aluminium and other non-ferrous metals, non-ferrous materials
S	S1–S10	High temperature alloys and titanium alloys	Heat resisting special alloys based on iron, nickel and cobalt, titanium and titanium alloys
H	H1–H4	Hard materials	Hardened steel, hardened cast iron materials, chilled cast iron
O	O1–O6	Other	Plastics, fibre glass and carbon fibre reinforced plastics, graphite

STEP 2

Determine the **basic shape** of the cutting insert:

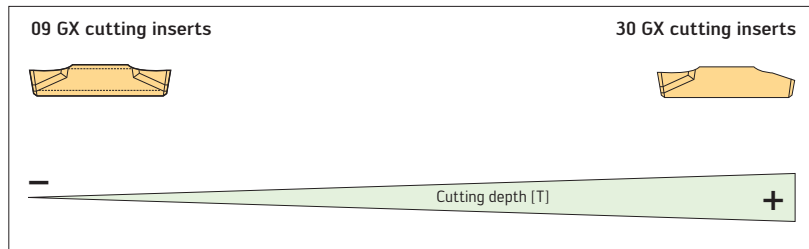

STEP 3

Select the **machining conditions**:

Type of workpiece	Machine stability, clamping system and workpiece		
	very good	good	moderate
Smooth cut Premachined surface	😊	😊	😞
Casting or forged skin Variable cutting depths	😊	😞	😞
Interrupted cuts	😞	😞	😞

STEP 4

Determine the indexable insert geometry via the cutting edge stability and the feed.



Geometry selection for grooving

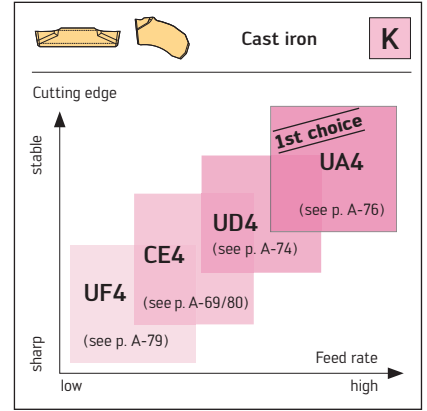
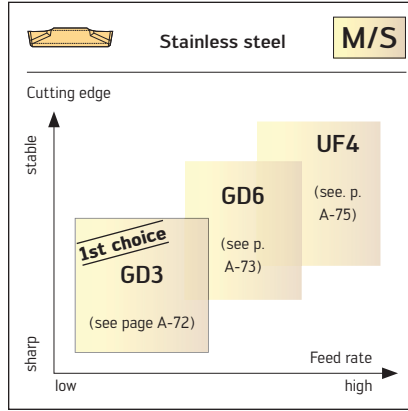
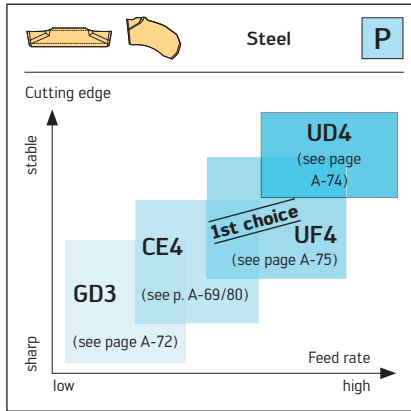

Geometry selection for groove turning

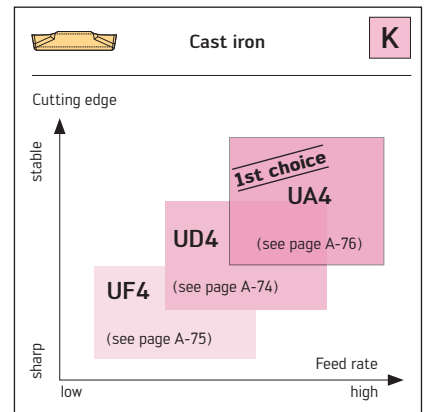
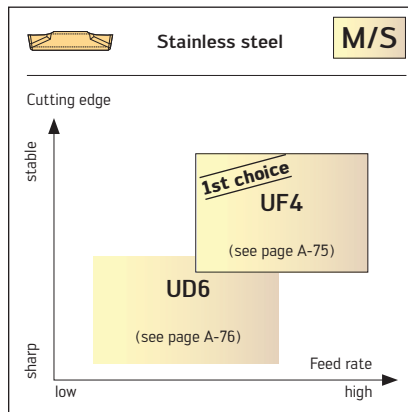
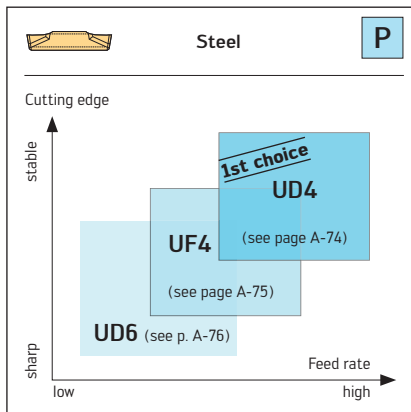

STEP 5

On the specified catalogue page you will find the cutting tool material recommendation, the feed value (f) and the cutting depth (a_p).

WALTER SELECT

Best insert for:

good

moderate

unfavourable

machining conditions

Walter Cut GX grooving inserts
Grooving and parting off
Tiger-tec® Silver

Designation	s mm	r mm	k	l mm	f mm	Stol mm	Htol mm	Indexable inserts				
								P	M	K	S	
GX16-1E200N02-CF5	2	0,2		16,6	0,04 - 0,12	±0,05	±0,15	WSM235	WSM335	WSM435	WSM535	WSM635
GX16-1E200R/L6-CF5	2	0,2	6°	16,6	0,03 - 0,10	±0,05	±0,15	WSM235	WSM335	WSM435	WSM535	WSM635
GX16-1E200R/L7-CF5	2		7°	16,2	0,03 - 0,10	±0,05	±0,15	WSM235	WSM335	WSM435	WSM535	WSM635

Cutting data for Walter Cut – Grooving and recessing
Carbide grades

Material group	Structure of main material groups and identification letters	Anneal hardness HB	Tensile strength R _m N/mm ²	Machining group	Cutting material grades	
					Starting values for cutting speed v _c [m/min]	
					WPP23	WSM135
Unalloyed steel	C ≤ 0.25%	annealed	125 428	P1	•••	200 200
	C > 0.25... ≤ 0.55%	annealed	190 639	P2	•••	180 180
	C > 0.25... ≤ 0.55%	tempered	210 708	P3	•••	170 170
	C > 0.55%	annealed	190 639	P4	•••	180 190
	C > 0.55%	tempered	300 1013	P5	•••	150 160
	Free-machining steel (short-chipping)	annealed	220 745	P6	•••	180 190

= Cutting data for wet machining
 = Dry machining is possible

STEP 6

Choose the **cutting data** for your selected cutting insert in the technical information from page A-140 onwards.





Walter Cut GX grooving inserts

Grooving and parting off

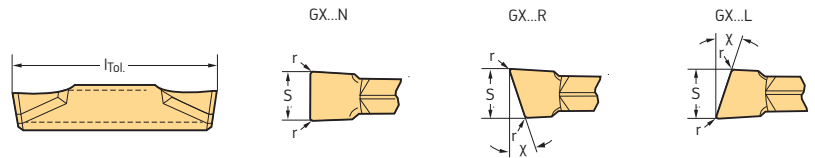
Tiger-tec® Silver



Indexable inserts

Designation	s mm	r mm	κ	l mm	f mm	s _{Tol} mm	l _{Tol} mm	P			M			K	S		
								HC			HC			HC	HC		
								WPP23	WSM23S	WSM33S	WSM43S	WSM23S	WSM33S	WSM43S	WPP23	WSM23S	WSM33S
 GX16-1E200N02-CE4	2	0,2		16,6	0,06 - 0,15	±0,05	±0,15			☹	☹	☹				☹	☹
GX16-1E200R/L6-CE4	2	0,2	6°	16,6	0,04 - 0,10	±0,05	±0,15			☹	☹	☹				☹	☹
GX16-1E250N02-CE4	2,5	0,2		16,6	0,07 - 0,18	±0,05	±0,15			☹	☹	☹				☹	☹
GX16-1E250R/L6-CE4	2,5	0,2	6°	16,6	0,05 - 0,12	±0,05	±0,15			☹	☹	☹				☹	☹
GX16-2E300N02-CE4	3	0,2		16,6	0,09 - 0,30	±0,05	±0,15			☹	☹	☹				☹	☹
GX16-2E300R/L6-CE4	3	0,2	6°	16,6	0,09 - 0,24	±0,05	±0,15			☹	☹	☹				☹	☹
GX24-2E300N02-CE4	3	0,2		24	0,09 - 0,30	±0,05	±0,15			☹	☹	☹				☹	☹
GX24-2E300N020-CE4	3	0,2		24	0,09 - 0,30	±0,05	±0,15	☹						☹			
GX24-2E300R/L6-CE4	3	0,2	6°	24,6	0,09 - 0,24	±0,05	±0,15	☹		☹	☹	☹		☹		☹	☹
GX24-3E400N03-CE4	4	0,3		24	0,10 - 0,32	±0,05	±0,15			☹	☹	☹				☹	☹
GX24-3E400N030-CE4	4	0,3		24	0,10 - 0,32	±0,05	±0,15	☹						☹			
GX24-3E400R/L6-CE4	4	0,2	6°	24,6	0,10 - 0,26	±0,05	±0,15			☹	☹	☹		☹		☹	☹
GX24-3E500N03-CE4	5	0,3		24	0,12 - 0,35	±0,05	±0,15			☹	☹	☹				☹	☹
GX24-3E500N030-CE4	5	0,3		24	0,12 - 0,35	±0,05	±0,15	☹						☹			
GX24-4E600N03-CE4	6	0,3		24	0,12 - 0,40	±0,05	±0,15			☹	☹	☹				☹	☹
GX24-4E600N030-CE4	6	0,3		24	0,12 - 0,40	±0,05	±0,15	☹						☹			
 GX16-1F200N02-CE4	2	0,2		16	0,04 - 0,12	±0,05	±0,15			☹	☹	☹				☹	☹
GX16-1F250N02-CE4	2,5	0,2		16	0,05 - 0,15	±0,05	±0,15			☹	☹	☹				☹	☹
GX24-2F300N02-CE4	3	0,2		24	0,09 - 0,30	±0,05	±0,15			☹	☹	☹				☹	☹
GX24-3F400N03-CE4	4	0,3		24	0,10 - 0,32	±0,05	±0,15			☹	☹	☹				☹	☹

l_{Tol} = Repeat accuracy when changing indexable insert

Radius tolerance r_{Tol} = ± 0.05

Parting off with diameters up to 32 mm is possible with these inserts (l = 16.6 mm).

HC = Coated carbide

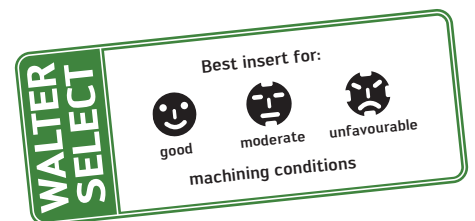

☹ ☹ ☹ New addition to range



Walter Cut GX grooving inserts

Grooving and parting off

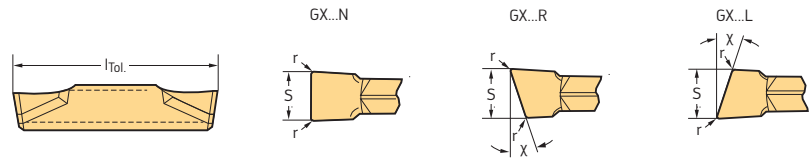
Tiger-tec® Silver



Indexable inserts

Designation	s mm	r mm	κ	l mm	f mm	S _{Tol} mm	l _{Tol} mm	P				M		K	S	
								HC				HC		HC	HC	
								WPP23	WSM23S	WSM33S	WSM4.3S	WSM23S	WSM33S	WSM4.3S	WPP23	WSM23S
 GX16-1E200N02-CF5	2	0,2		16,6	0,04 - 0,12	±0,05	±0,15		☹	☹	☹	☹			☹	☹
GX16-1E200R/L6-CF5	2	0,2	6°	16,6	0,03 - 0,10	±0,05	±0,15		☹	☹	☹	☹			☹	☹
GX16-1E200R/L7-CF5	2		7°	16,2	0,03 - 0,10	±0,05	±0,15		☹		☹				☹	
GX16-1E200R/L15-CF5	2		15°	16,2	0,03 - 0,10	±0,05	±0,15		☹		☹				☹	
GX16-1E250N02-CF5	2,5	0,2		16,6	0,05 - 0,15	±0,05	±0,15		☹	☹	☹	☹			☹	☹
GX16-1E250R/L6-CF5	2,5	0,2	6°	16,6	0,03 - 0,12	±0,05	±0,15		☹	☹	☹	☹			☹	☹
GX16-2E300N02-CF5	3	0,2		16,6	0,08 - 0,20	±0,05	±0,15		☹	☹	☹	☹			☹	☹
GX16-2E300R/L6-CF5	3	0,2	6°	16,6	0,04 - 0,16	±0,05	±0,15		☹	☹	☹	☹			☹	☹
GX16-2E300R/L7-CF5	3		7°	16,2	0,04 - 0,13	±0,05	±0,15		☹		☹				☹	
GX16-2E300R/L15-CF5	3		15°	16,2	0,04 - 0,13	±0,05	±0,15		☹		☹				☹	
GX24-2E300N02-CF5	3	0,2		24	0,08 - 0,20	±0,05	±0,15		☹	☹	☹	☹			☹	☹
GX24-2E300R/L6-CF5	3	0,2	6°	24,6	0,04 - 0,16	±0,05	±0,15		☹	☹	☹	☹			☹	☹
GX24-3E400N02-CF5	4	0,2		24	0,10 - 0,22	±0,05	±0,15		☹	☹	☹	☹			☹	☹
GX24-3E400R/L6-CF5	4	0,2	6°	24,6	0,10 - 0,18	±0,05	±0,15		☹	☹	☹	☹			☹	☹
GX24-3E500N03-CF5	5	0,3		24	0,10 - 0,25	±0,05	±0,15		☹	☹	☹	☹			☹	☹
 GX16-1F200N02-CF5	2	0,2		16	0,03 - 0,12	±0,05	±0,15		☹	☹	☹	☹			☹	☹
GX16-1F250N02-CF5	2,5	0,2		16	0,03 - 0,15	±0,05	±0,15		☹	☹	☹	☹			☹	☹
GX24-2F300N02-CF5	3	0,2		23,7	0,04 - 0,20	±0,05	±0,15		☹	☹	☹	☹			☹	☹
GX24-3F400N02-CF5	4	0,2		23,7	0,10 - 0,22	±0,05	±0,15		☹	☹	☹	☹			☹	☹
GX24-3F500N03-CF5	5	0,3		23,7	0,10 - 0,25	±0,05	±0,15		☹	☹	☹	☹			☹	☹

l_{Tol} = Repeat accuracy when changing indexable insert

Radius tolerance r_{Tol} = ± 0.05

Parting off with diameters up to 32 mm is possible with these inserts (l = 16.6 mm).

HC = Coated carbide



Walter Cut GX grooving inserts

Grooving and parting off

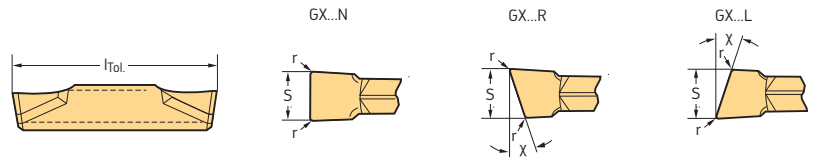
Tiger-tec® Silver



Indexable inserts

Designation	s mm	r mm	κ	l mm	f mm	s _{Tol} mm	l _{Tol} mm	P			M			K	S			
								HC	HC	HC	HC	HC	HC	HC	HC	HC		
								WPP23	WSM23S	WSM33S	WSM43S	WSM23S	WSM33S	WSM43S	WPP23	WSM23S	WSM33S	WSM43S
 GX16-0E150N01-CF6	1,5	0,15		16,6	0,03 - 0,10	±0,02	±0,05			☹	☹	☹	☹	☹			☹	☹
GX16-0E150R/L10-CF6	1,5	0,15	10°	16,6	0,03 - 0,10	±0,02	±0,05			☹	☹	☹	☹	☹			☹	☹
GX16-1E200N02-CF6	2	0,2		16,6	0,03 - 0,12	±0,05	±0,15			☹	☹	☹	☹	☹			☹	☹
GX16-1E200R/L6-CF6	2	0,2	6°	16,6	0,03 - 0,10	±0,05	±0,15			☹	☹	☹	☹	☹			☹	☹
GX16-1E200R/L7-CF6	2		7°	16,2	0,03 - 0,10	±0,05	±0,15			☹	☹	☹	☹	☹			☹	☹
GX16-1E200R/L15-CF6	2		15°	16,2	0,03 - 0,10	±0,05	±0,15			☹	☹	☹	☹	☹			☹	☹
GX16-1E250N02-CF6	2,5	0,2		16,6	0,03 - 0,15	±0,05	±0,15			☹	☹	☹	☹	☹			☹	☹
GX16-1E250R/L6-CF6	2,5	0,2	6°	16,6	0,03 - 0,12	±0,05	±0,15			☹	☹	☹	☹	☹			☹	☹
GX16-2E300N02-CF6	3	0,2		16,6	0,04 - 0,20	±0,05	±0,15			☹	☹	☹	☹	☹			☹	☹
GX16-2E300R/L6-CF6	3	0,2	6°	16,6	0,04 - 0,16	±0,05	±0,15			☹	☹	☹	☹	☹			☹	☹
GX16-2E300R/L7-CF6	3		7°	16,2	0,04 - 0,13	±0,05	±0,15			☹	☹	☹	☹	☹			☹	☹
GX16-2E300R/L15-CF6	3		15°	16,2	0,04 - 0,13	±0,05	±0,15			☹	☹	☹	☹	☹			☹	☹
GX24-2E300N02-CF6	3	0,2		24,6	0,04 - 0,20	±0,05	±0,15			☹	☹	☹	☹	☹			☹	☹
GX24-2E300R/L6-CF6	3	0,2	6°	24,6	0,04 - 0,16	±0,05	±0,15			☹	☹	☹	☹	☹			☹	☹
 GX16-1F200N02-CF6	2	0,2		16	0,03 - 0,12	±0,05	±0,15			☹	☹	☹	☹	☹			☹	☹
GX16-1F250N02-CF6	2,5	0,2		16	0,03 - 0,15	±0,05	±0,15			☹	☹	☹	☹	☹			☹	☹
GX24-2F300N02-CF6	3	0,2		24	0,04 - 0,20	±0,05	±0,15			☹	☹	☹	☹	☹			☹	☹

l_{Tol} = Repeat accuracy when changing indexable insert

Radius tolerance r_{Tol} = ± 0.05

Parting off with diameters up to 32 mm is possible with these inserts (l = 16.6 mm).

HC = Coated carbide

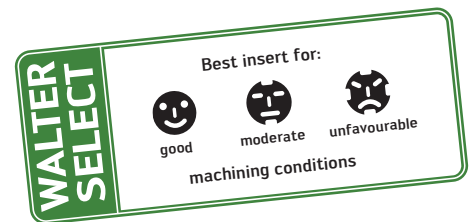

Walter Cut GX grooving inserts

Grooving and parting off

Tiger-tec® Silver

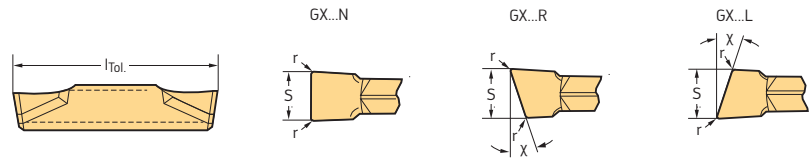

Indexable inserts

Designation	s mm	r mm	k	l mm	f mm	S _{Tol} mm	l _{Tol} mm	P				M		K	S	
								HC				HC		HC	HC	
								WPP23	WSM23S	WSM33S	WSM4.3S	WSM23S	WSM33S	WSM4.3S	WPP23	WSM23S
GX09-1E200N02-GD3	2	0,2		9	0,04 - 0,12	±0,02	±0,05		☺	☹	☹		☺		☹	☹
GX09-1E250N02-GD3	2,5	0,2		9	0,04 - 0,14	±0,02	±0,05		☺	☹	☹		☺		☹	☹
GX09-2E300N03-GD3	3	0,3		9	0,06 - 0,18	±0,02	±0,05		☺	☹	☹		☺		☹	☹
GX09-2E300N030-GD3	3	0,3		9	0,06 - 0,18	±0,02	±0,05	☺					☹			
GX09-2E350N03-GD3	3,5	0,3		9	0,06 - 0,18	±0,02	±0,05		☺	☹	☹		☺		☹	☹
GX16-1E200N02-GD3	2	0,2		16	0,04 - 0,12	±0,02	±0,05		☺	☹	☹		☺		☹	☹
GX16-1E200N020-GD3	2	0,2		16	0,04 - 0,12	±0,02	±0,05	☺					☹			
GX16-1E250N02-GD3	2,5	0,2		16	0,04 - 0,14	±0,02	±0,05		☺	☹	☹		☺		☹	☹
GX16-1E250N020-GD3	2,5	0,2		16	0,04 - 0,14	±0,02	±0,05	☺					☹			
GX16-2E300N03-GD3	3	0,3		16	0,06 - 0,18	±0,02	±0,05		☺	☹	☹		☺		☹	☹
GX16-2E300N030-GD3	3	0,3		16	0,06 - 0,18	±0,02	±0,05	☺					☹			
GX16-3E400N04-GD3	4	0,4		16	0,10 - 0,20	±0,02	±0,05		☺	☹	☹		☺		☹	☹
GX16-3E400N040-GD3	4	0,4		16	0,10 - 0,20	±0,02	±0,05	☺					☹			
GX16-3E500N04-GD3	5	0,4		16	0,12 - 0,25	±0,02	±0,05		☺	☹	☹		☺		☹	☹
GX16-3E500N040-GD3	5	0,4		16	0,12 - 0,25	±0,02	±0,05	☺					☹			
GX24-2E300N03-GD3	3	0,3		24	0,06 - 0,18	±0,05	±0,15		☺	☹	☹		☺		☹	☹
GX24-2E300N030-GD3	3	0,3		24	0,06 - 0,18	±0,05	±0,15	☺					☹			
GX24-3E400N04-GD3	4	0,4		24	0,10 - 0,20	±0,05	±0,15		☺	☹	☹		☺		☹	☹
GX24-3E400N040-GD3	4	0,4		24	0,10 - 0,20	±0,05	±0,15	☺					☹			
GX24-3E500N04-GD3	5	0,4		24	0,12 - 0,25	±0,05	±0,15		☺	☹	☹		☺		☹	☹
GX24-3E500N040-GD3	5	0,4		24	0,12 - 0,25	±0,05	±0,15	☺					☹			
GX24-4E600N05-GD3	6	0,5		24	0,14 - 0,28	±0,05	±0,15		☺	☹	☹		☺		☹	☹
GX24-4E600N050-GD3	6	0,5		24	0,14 - 0,28	±0,05	±0,15	☺					☹			

l_{Tol} = Repeat accuracy when changing indexable insert
 Radius tolerance r_{Tol} = ± 0.05

HC = Coated carbide



Walter Cut GX grooving inserts

Grooving and parting off

Tiger-tec® Silver

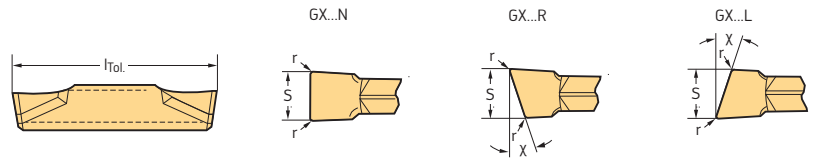

Indexable inserts

Designation	s mm	r mm	k	l mm	f mm	s _{Tol} mm	l _{Tol} mm	P			M			K	S		
								HC			HC			HC	HC		
								WPP23	WSM23S	WSM33S	WSM43S	WSM23S	WSM33S	WSM43S	WPP23	WSM23S	WSM33S
GX16-1E200N02-GD6	2	0,2		16	0,04 - 0,12	±0,05	±0,15	☺	☺	☺	☺	☺	☺	☺	☺	☺	☺
GX16-1E250N02-GD6	2,5	0,2		16	0,06 - 0,17	±0,05	±0,15	☺	☺	☺	☺	☺	☺	☺	☺	☺	☺
GX16-2E300N03-GD6	3	0,3		16	0,08 - 0,18	±0,05	±0,15	☺	☺	☺	☺	☺	☺	☺	☺	☺	☺
GX16-3E400N04-GD6	4	0,4		16	0,10 - 0,22	±0,05	±0,15	☺	☺	☺	☺	☺	☺	☺	☺	☺	☺
GX16-3E500N04-GD6	5	0,4		16	0,12 - 0,24	±0,05	±0,15	☺	☺	☺	☺	☺	☺	☺	☺	☺	☺
GX16-4E600N05-GD6	6	0,5		16	0,14 - 0,30	±0,05	±0,15	☺	☺	☺	☺	☺	☺	☺	☺	☺	☺
GX24-2E300N03-GD6	3	0,3		24	0,08 - 0,18	±0,05	±0,15	☺	☺	☺	☺	☺	☺	☺	☺	☺	☺
GX24-3E400N04-GD6	4	0,4		24	0,10 - 0,22	±0,05	±0,15	☺	☺	☺	☺	☺	☺	☺	☺	☺	☺
GX24-3E500N04-GD6	5	0,4		24	0,12 - 0,24	±0,05	±0,15	☺	☺	☺	☺	☺	☺	☺	☺	☺	☺
GX24-4E600N05-GD6	6	0,5		24	0,14 - 0,30	±0,05	±0,15	☺	☺	☺	☺	☺	☺	☺	☺	☺	☺

l_{Tol} = Repeat accuracy when changing indexable insert
 Radius tolerance r_{Tol} = ± 0.05

HC = Coated carbide

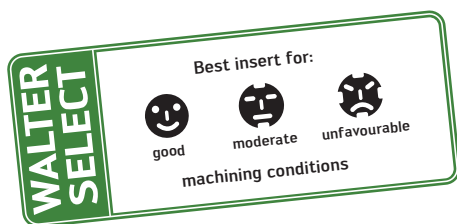

Walter Cut GX grooving inserts

Grooving and longitudinal turning

Tiger-tec® Silver

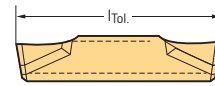

GX...N

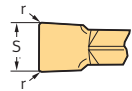

Indexable inserts

Designation	s mm	r mm	l mm	f mm	ap mm	s _{Tol} mm	l _{Tol} mm	P			M			K			S		
								HC			HC			HC			HC		
								WPP23	WSM23S	WSM33S	WSM43S	WSM23S	WSM33S	WSM43S	WAK20	WAK30	WPP23	WSM23S	WSM33S
GX24-2E300N03-UD4	3	0,3	24	0,10 - 0,20	0,4 - 2,0	±0,05	±0,15		☹		☹						☹		
GX24-3E400N04-UD4	4	0,4	24	0,10 - 0,30	0,5 - 2,8	±0,05	±0,15		☹		☹						☹		
GX24-3E400N08-UD4	4	0,8	24	0,10 - 0,30	0,9 - 2,8	±0,05	±0,15		☹		☹						☹		
GX24-3E500N04-UD4	5	0,4	24	0,12 - 0,35	0,5 - 3,0	±0,05	±0,15		☹		☹						☹		
GX24-3E500N08-UD4	5	0,8	24	0,12 - 0,35	0,9 - 3,0	±0,05	±0,15		☹		☹						☹		
GX24-4E600N05-UD4	6	0,5	24	0,14 - 0,40	0,6 - 3,5	±0,05	±0,15		☹		☹						☹		
GX24-4E600N08-UD4	6	0,8	24	0,14 - 0,40	0,9 - 3,5	±0,05	±0,15		☹		☹						☹		
GX30-5E800N08-UD4	8	0,8	30	0,14 - 0,40	0,6 - 4,0	±0,05	±0,15		☹		☹						☹		
GX30-5E800N12-UD4	8	1,2	30	0,14 - 0,40	0,6 - 3,5	±0,05	±0,15		☹		☹						☹		

l_{Tol} = Repeat accuracy when changing indexable insert
 Radius tolerance r_{Tol} = ± 0.05

HC = Coated carbide

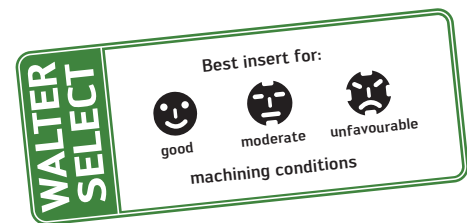

Walter Cut GX grooving inserts

Grooving and longitudinal turning

Tiger-tec® Silver

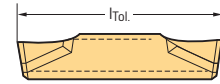

GX...N

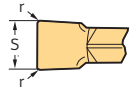

Indexable inserts

Designation	s mm	r mm	l mm	f mm	ap mm	s _{Tol} mm	l _{Tol} mm	P			M			K			S		
								HC			HC			HC			HC		
								WPP23	WSM23S	WSM33S	WSM43S	WSM23S	WSM33S	WSM43S	WAK20	WAK30	WPP23	WSM23S	WSM33S
GX09-1E200N02-UF4	2	0,2	9	0,10 - 0,15	0,3 - 1,0	±0,05	±0,15												
GX09-2E300N03-UF4	3	0,3	9	0,10 - 0,20	0,4 - 1,5	±0,05	±0,15												
GX16-1E200N02-UF4	2	0,2	16	0,10 - 0,15	0,3 - 1,2	±0,05	±0,15												
GX16-1E200N020-UF4	2	0,2	16	0,10 - 0,15	0,3 - 1,2	±0,05	±0,15												
GX16-1E250N02-UF4	2,5	0,2	16	0,10 - 0,18	0,3 - 1,3	±0,05	±0,15												
GX16-1E250N020-UF4	2,5	0,2	16	0,10 - 0,18	0,3 - 1,3	±0,05	±0,15												
GX16-2E300N03-UF4	3	0,3	16	0,10 - 0,20	0,4 - 2,0	±0,05	±0,15												
GX16-2E300N030-UF4	3	0,3	16	0,10 - 0,20	0,4 - 2,0	±0,05	±0,15												
GX16-3E400N04-UF4	4	0,4	16	0,10 - 0,30	0,5 - 2,8	±0,05	±0,15												
GX16-3E400N040-UF4	4	0,4	16	0,10 - 0,30	0,5 - 2,8	±0,05	±0,15												
GX16-3E500N04-UF4	5	0,4	16	0,12 - 0,35	0,5 - 3,0	±0,05	±0,15												
GX16-3E500N040-UF4	5	0,4	16	0,12 - 0,35	0,5 - 3,0	±0,05	±0,15												
GX16-4E600N05-UF4	6	0,5	16	0,14 - 0,40	0,6 - 3,5	±0,05	±0,15												
GX16-4E600N050-UF4	6	0,5	16	0,14 - 0,40	0,6 - 3,5	±0,05	±0,15												
GX24-2E300N03-UF4	3	0,3	24	0,10 - 0,20	0,4 - 2,0	±0,05	±0,15												
GX24-2E300N030-UF4	3	0,3	24	0,10 - 0,20	0,4 - 2,0	±0,05	±0,15												
GX24-2E318N030-UF4	3,18	0,3	24	0,08 - 0,35	2,5	±0,05	±0,15												
GX24-2E318N03-UF4	3,18	0,3	24	0,08 - 0,35	2,5	±0,05	±0,15												
GX24-3E400N04-UF4	4	0,4	24	0,10 - 0,30	0,5 - 2,8	±0,05	±0,15												
GX24-3E400N040-UF4	4	0,4	24	0,10 - 0,30	0,5 - 2,8	±0,05	±0,15												
GX24-3E400N08-UF4	4	0,8	24	0,10 - 0,30	0,9 - 2,8	±0,05	±0,15												
GX24-3E400N080-UF4	4	0,8	24	0,10 - 0,30	0,9 - 2,8	±0,05	±0,15												
GX24-3E475N04-UF4	4,75	0,4	24	0,10 - 0,40	3	±0,05	±0,15												
GX24-3E475N040-UF4	4,75	0,4	24	0,10 - 0,40	3	±0,05	±0,15												
GX24-3E500N04-UF4	5	0,4	24	0,12 - 0,35	0,5 - 3,0	±0,05	±0,15												
GX24-3E500N040-UF4	5	0,4	24	0,12 - 0,35	0,5 - 3,0	±0,05	±0,15												
GX24-3E500N08-UF4	5	0,8	24	0,12 - 0,35	0,9 - 3,0	±0,05	±0,15												
GX24-3E500N080-UF4	5	0,8	24	0,12 - 0,35	0,9 - 3,0	±0,05	±0,15												

l_{Tol} = Repeat accuracy when changing indexable insert
 Radius tolerance r_{Tol} = ± 0.05

HC = Coated carbide



New addition to range

Walter Cut GX grooving inserts

Grooving and longitudinal turning

Tiger-tec® Silver

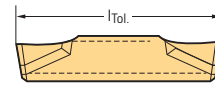

GX...N

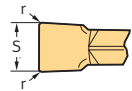

Indexable inserts

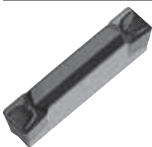
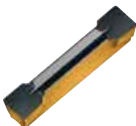
Designation	s mm	r mm	l mm	f mm	ap mm	s _{Tol} mm	l _{Tol} mm	P			M			K		S			
								HC			HC			HC		HC			
								WPP23	WSM23S	WSM33S	WSM43S	WSM23S	WSM33S	WSM43S	WAK20	WAK30	WPP23	WSM23S	WSM33S
 GX24-4E600N05-UF4 GX24-4E600N050-UF4 GX24-4E600N08-UF4 GX24-4E600N080-UF4 GX24-4E635N05-UF4 GX24-4E635N050-UF4	6	0,5	24	0,14 - 0,40	0,6 - 3,5	±0,05	±0,15												
	6	0,5	24	0,14 - 0,40	0,6 - 3,5	±0,05	±0,15	☺											
	6	0,8	24	0,14 - 0,40	0,9 - 3,5	±0,05	±0,15												
	6	0,8	24	0,14 - 0,40	0,9 - 3,5	±0,05	±0,15	☺											
	6,35	0,5	24	0,15 - 0,60	3,5	±0,05	±0,15												
	6,35	0,5	24	0,15 - 0,60	3,5	±0,05	±0,15	☺											
 GX16-1E200N02-UD6 GX16-1E250N02-UD6 GX16-2E300N03-UD6 GX16-3E400N04-UD6 GX16-3E500N04-UD6 GX16-4E600N05-UD6 GX24-2E300N03-UD6 GX24-3E400N04-UD6 GX24-3E500N04-UD6 GX24-4E600N05-UD6	2	0,2	16	0,06 - 0,15	0,3 - 1,2	±0,05	±0,15												
	2,5	0,2	16	0,08 - 0,14	0,3 - 1,3	±0,05	±0,15												
	3	0,3	16	0,10 - 0,20	0,4 - 2,0	±0,05	±0,15												
	4	0,4	16	0,12 - 0,25	0,5 - 2,8	±0,05	±0,15												
	5	0,4	16	0,12 - 0,30	0,5 - 3,0	±0,05	±0,15												
	6	0,5	16	0,14 - 0,35	0,6 - 3,5	±0,05	±0,15												
	3	0,3	24	0,10 - 0,20	0,4 - 2,0	±0,05	±0,15												
	4	0,4	24	0,12 - 0,25	0,5 - 2,8	±0,05	±0,15												
	5	0,4	24	0,12 - 0,30	0,5 - 3,0	±0,05	±0,15												
	6	0,5	24	0,14 - 0,35	0,6 - 3,5	±0,05	±0,15												
 GX16-1E200N020-UA4 GX16-2E300N030-UA4 GX16-3E400N040-UA4 GX16-3E500N040-UA4 GX16-4E600N050-UA4 GX24-2E300N030-UA4 GX24-3E400N040-UA4 GX24-3E500N040-UA4 GX24-4E600N050-UA4	2	0,2	16	0,08 - 0,15	0,3 - 1,2	±0,05	±0,15												
	3	0,3	16	0,10 - 0,22	0,4 - 2,0	±0,05	±0,15												
	4	0,4	16	0,10 - 0,35	0,5 - 2,8	±0,05	±0,15												
	5	0,4	16	0,12 - 0,35	0,5 - 3,0	±0,05	±0,15												
	6	0,5	16	0,14 - 0,40	0,6 - 3,5	±0,05	±0,15												
	3	0,3	24	0,10 - 0,22	0,4 - 2,0	±0,05	±0,15												
	4	0,4	24	0,10 - 0,35	0,5 - 2,8	±0,05	±0,15												
	5	0,4	24	0,12 - 0,35	0,5 - 3,0	±0,05	±0,15												

 l_{Tol} = Repeat accuracy when changing indexable insert

 Radius tolerance r_{Tol} = ± 0.05

HC = Coated carbide



New addition to range

Walter Cut GX grooving inserts Circlip grooves

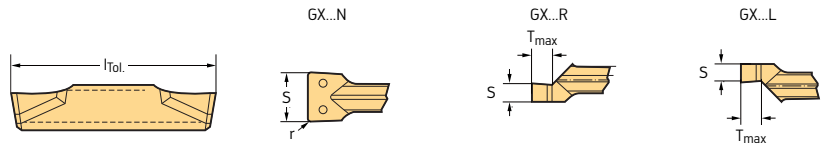

Indexable inserts

Designation	s mm	r mm	T _{max} mm	l mm	f mm	S _{Tol} mm	l _{Tol} mm	P		M		K		S	
								HC		HC		HC		HC	
								WSM23S	WSM33S	WTA33	WSM23S	WSM33S	WTA33	WSM23S	WSM33S
GX09-1S1.00R/L	1		1,14	9	0,05 - 0,10	±0,02	±0,05		☹			☹			
GX09-1S1.20R/L	1,2		1,34	9	0,05 - 0,10	±0,02	±0,05		☹			☹			
GX09-1S1.40R/L	1,4		1,53	9	0,05 - 0,10	±0,02	±0,05		☹			☹			
GX09-1S1.70R/L	1,7		1,82	9	0,05 - 0,10	±0,02	±0,05		☹			☹			
GX09-1S1.95N	2	0,1		9	0,05 - 0,10	±0,02	±0,05		☹			☹			
GX09-1S2.25N	2,3	0,1		9	0,05 - 0,12	±0,02	±0,05		☹			☹			
GX09-2S2.75N	2,8	0,1		9	0,05 - 0,12	±0,02	±0,05		☹			☹			
GX09-2S3.25N	3,3	0,1		9	0,05 - 0,12	±0,02	±0,05		☹			☹			
GX16-2S0.60R/L	0,6		0,75	16	0,05 - 0,10	±0,02	±0,05		☹			☹			
GX16-2S0.80R/L	0,8		0,94	16	0,05 - 0,10	±0,02	±0,05		☹			☹			
GX16-2S0.90R/L	0,9		1,04	16	0,05 - 0,10	±0,02	±0,05		☹			☹			
GX16-2S1.00R/L	1		1,14	16	0,05 - 0,10	±0,02	±0,05		☹			☹			
GX16-2S1.20R/L	1,2		1,34	16	0,05 - 0,10	±0,02	±0,05		☹			☹			
GX16-2S1.40R/L	1,4		1,53	16	0,05 - 0,10	±0,02	±0,05		☹			☹			
GX16-2S1.70R/L	1,7		1,82	16	0,05 - 0,10	±0,02	±0,05		☹			☹			
GX16-2S1.95R/L	2		2,07	16	0,05 - 0,10	±0,02	±0,05		☹			☹			
GX16-2S2.25R/L	2,3		2,36	16	0,05 - 0,12	±0,02	±0,05		☹			☹			
GX16-2S2.75N	2,8	0,1		16	0,05 - 0,12	±0,02	±0,05		☹			☹			
GX16-2S3.25N	3,3	0,1		16	0,07 - 0,14	±0,02	±0,05		☹			☹			
GX16-3S4.25N	4,3	0,2		16	0,07 - 0,20	±0,02	±0,05		☹			☹			
GX16-4S5.25N	5,3	0,2		16	0,08 - 0,20	±0,02	±0,05		☹			☹			

l_{Tol} = Repeat accuracy when changing indexable insert
 Radius tolerance r_{Tol} = ± 0.05

HC = Coated carbide

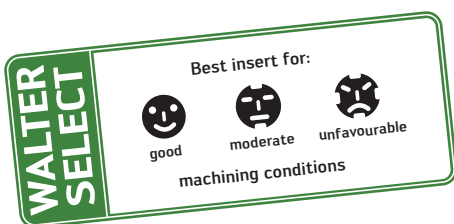



Walter Cut GX grooving inserts

Grooving and longitudinal turning

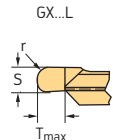
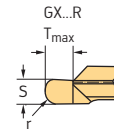
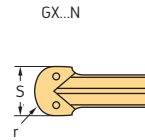
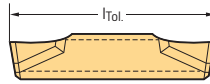
Tiger-tec® Silver



Indexable inserts

Designation	s mm	r mm	l mm	f mm	ap mm	s _{Tol} mm	l _{Tol} mm	P							M				K		N		S			
								WPP23	WSM13S	WSM23S	WSM33S	WSM33	WSP43	WTA33	WSM13S	WSM23S	WSM33S	WSM33	WPP23	WTA33	WK1	WSM13S	WSM23S	WSM33S	HC	HC
 GX16-1E200N10-RD4	2	1	16	0,08 - 0,25	0,2 - 1,0	±0,05	±0,15	☺	☺	☺							☺	☺							☺	☺
GX16-1E239N12-RD4	2,39	1,2	16	0,08 - 0,25	0,2 - 1,0	±0,05	±0,15	☺		☺							☺	☺								☺
GX24-2E300N15-RD4	3	1,5	24	0,10 - 0,35	0,5 - 1,5	±0,05	±0,15			☺							☺	☺								☺
GX24-2E300N150-RD4	3	1,5	24	0,08 - 0,35	1,5	±0,05	±0,15	☺										☺	☺							
GX24-2E318N159-RD4	3,18	1,59	24	0,08 - 0,35	1,6	±0,05	±0,15	☺										☺	☺							
GX24-2E318N16-RD4	3,18	1,59	24	0,08 - 0,35	1,6	±0,05	±0,15			☺								☺	☺							☺
GX24-3E400N20-RD4	4	2	24	0,15 - 0,50	0,5 - 2,0	±0,05	±0,15			☺								☺	☺							☺
GX24-3E400N200-RD4	4	2	24	0,10 - 0,40	2	±0,05	±0,15	☺											☺	☺						
GX24-3E475N238-RD4	4,75	2,38	24	0,10 - 0,40	2,4	±0,05	±0,15	☺											☺	☺						
GX24-3E475N24-RD4	4,75	2,38	24	0,10 - 0,40	2,4	±0,05	±0,15			☺									☺	☺						☺
GX24-3E500N25-RD4	5	2,5	24	0,17 - 0,70	0,5 - 2,5	±0,05	±0,15			☺									☺	☺						☺
GX24-3E500N250-RD4	5	2,5	24	0,12 - 0,50	2,5	±0,05	±0,15	☺												☺	☺					
GX24-4E600N30-RD4	6	3	24	0,17 - 0,70	0,5 - 3,0	±0,05	±0,15			☺										☺	☺					☺
GX24-4E600N300-RD4	6	3	24	0,15 - 0,60	3	±0,05	±0,15	☺												☺	☺					
GX24-4E635N318-RD4	6,35	3,18	24	0,15 - 0,60	3	±0,05	±0,15	☺												☺	☺					
GX24-4E635N32-RD4	6,35	3,18	24	0,15 - 0,60	3	±0,05	±0,15			☺											☺	☺				☺
 GX24-2E300N15-RF8	3	1,5	24	0,10 - 0,30	0,1 - 1,5	±0,02	±0,02	☺	☺								☺	☺						☺	☺	
GX24-3E400N20-RF8	4	2	24	0,12 - 0,45	0,1 - 2,0	±0,02	±0,02	☺	☺								☺	☺						☺	☺	
GX24-3E500N25-RF8	5	2,5	24	0,15 - 0,50	0,1 - 2,5	±0,02	±0,02	☺	☺								☺	☺						☺	☺	
GX24-4E600N30-RF8	6	3	24	0,15 - 0,55	0,1 - 3,0	±0,02	±0,02	☺	☺								☺	☺						☺	☺	
 GX09-1R1.00N	2	1	9	0,05 - 0,17	1	±0,02	±0,02													☺	☺					
GX09-1R1.20N	2,4	1,2	9	0,05 - 0,17	1,2	±0,02	±0,02														☺	☺				
GX16-2R1.00R/L*	2	1	16	0,05 - 0,17	1	±0,02	±0,02														☺	☺				
GX16-2R1.20R/L*	2,4	1,2	16	0,05 - 0,17	1,2	±0,02	±0,02															☺	☺			
GX16-2R1.50N	3	1,5	16	0,10 - 0,20	1,5	±0,02	±0,02															☺	☺			
GX16-3R2.00N	4	2	16	0,10 - 0,30	2	±0,02	±0,02																☺	☺		
GX16-3R2.50N	5	2,5	16	0,15 - 0,35	2,5	±0,02	±0,02																	☺	☺	
GX16-4R3.00N	6	3	16	0,15 - 0,40	3	±0,02	±0,02																		☺	

l_{Tol} = Repeat accuracy when changing indexable insert

Radius tolerance r_{Tol} = ± 0.05

* T_{max} values for GX16-2R1.00R/L = 2.18 mm and GX162R1,20R/L = 2.58 mm

HC = Coated carbide

HW = Uncoated carbide



☺ ☺ ☺ New addition to range



Walter Cut GX/LX grooving inserts

Grooving and longitudinal turning

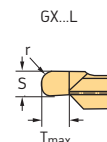
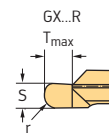
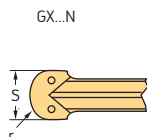
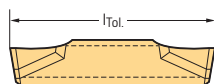
Tiger-tec® Silver



Indexable inserts

Designation	s mm	r mm	l mm	f mm	ap mm	s_Tol mm	l_Tol mm	P								M				K		N		S			
								WPP23	WSM13S	WSM23S	WSM33S	WSM33	WSP43	WTA33	WSM13S	WSM23S	WSM33S	WSM33	WPP23	WTA33	WK1	WSM13S	WSM23S	WSM33S			
 GX24-4R300N-RK8	6	3	25,4	0,10 - 0,30	4	±0,02	±0,05																				
 GX24-5R400N-RK8	8	4	25,4	0,10 - 0,35	5	±0,02	±0,05																				
 LX-E800N400-RD3	8	4	19	0,15 - 0,50	4	±0,08	±0,15	☺												☺	☹						
 LX-E800N080-UE4	8	0,8	19	0,20 - 0,50	0,9 - 5,0	-0,08	±0,15	☺												☺	☹						

l_{Tol} = Repeat accuracy when changing indexable insert
 Radius tolerance $r_{Tol} = \pm 0.05$

HC = Coated carbide
 HW = Uncoated carbide

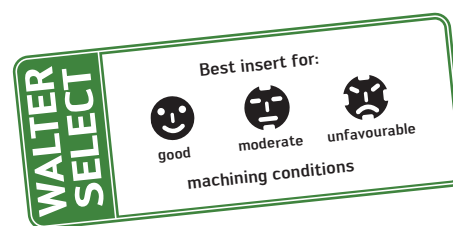



Walter Cut SX grooving inserts

Grooving and parting off

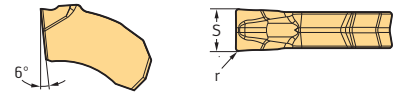
Tiger-tec® Silver



Indexable inserts

Designation	s mm	r mm	f mm	s _{Tol} mm	l _{Tol} mm	P			M			S		
						HC			HC			HC		
						WSM23S	WSM33S	WSM4.3S	WSM23S	WSM33S	WSM4.3S	WSM23S	WSM33S	WSM4.3S
 SX-2E200N02-CE4 SX-3E300N02-CE4 SX-4E400N02-CE4 SX-5E500N04-CE4 SX-6E600N04-CE4	2	0,2	0,06 - 0,15	±0,05	±0,01	☹	☹	☹	☺	☺	☺	☹	☹	
	3	0,2	0,09 - 0,30	±0,05	±0,01	☹	☹	☹	☺	☺	☺	☹	☹	
	4	0,2	0,10 - 0,32	±0,05	±0,01	☹	☹	☹	☺	☺	☺	☹	☹	
	5	0,4	0,12 - 0,35	±0,05	±0,01	☹	☹	☹	☺	☺	☺	☹	☹	
	6	0,4	0,12 - 0,40	±0,05	±0,01	☹	☹	☹	☺	☺	☺	☹	☹	
 SX-2E200N02-CF5 SX-3E300N02-CF5 SX-4E400N02-CF5 SX-5E500N04-CF5 SX-6E600N04-CF5	2	0,2	0,04 - 0,12	±0,05	±0,01	☹	☹	☹	☺	☺	☺	☹	☹	
	3	0,2	0,08 - 0,20	±0,05	±0,01	☹	☹	☹	☺	☺	☺	☹	☹	
	4	0,2	0,10 - 0,22	±0,05	±0,01	☹	☹	☹	☺	☺	☺	☹	☹	
	5	0,4	0,10 - 0,25	±0,05	±0,01	☹	☹	☹	☺	☺	☺	☹	☹	
	6	0,4	0,10 - 0,30	±0,05	±0,01	☹	☹	☹	☺	☺	☺	☹	☹	
 SX-2E200N02-CF6 SX-3E300N02-CF6	2	0,2	0,03 - 0,12	±0,05	±0,01	☹	☹	☹	☺	☺	☺	☹	☹	
	3	0,2	0,04 - 0,20	±0,05	±0,01	☹	☹	☹	☺	☺	☺	☹	☹	

l_{Tol} = Repeat accuracy when changing indexable insert
 Radius tolerance r_{Tol} = ± 0.05

HC = Coated carbide

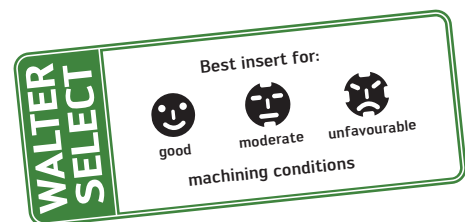



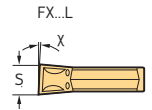
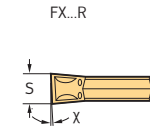
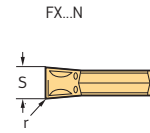
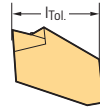

Walter Cut FX grooving inserts

Grooving and parting off

Tiger-tec®



Indexable inserts

Designation	s mm	r mm	κ	f mm	s _{Tol} mm	l _{Tol} mm	P					M				K	N	S					
							HC					HC				HC				HW	HC		
							WPP23	WSM23S	WSM33S	WSM33	WSP43	WSM23S	WSM33S	WSM33	WSP43	WPP23	WK1	WSM23S	WSM33S	WSM33	WSP43		
 FX2.2-E220N010-CE4	2,2	0,1		0,05 - 0,15	±0,05	±0,10	☺		☹	☹				☹	☹	☹						☹	☹
FX3.1-E310N015-CE4	3,1	0,15		0,09 - 0,30	±0,05	±0,10	☺		☹	☹				☹	☹	☹						☹	☹
FX3.1-E310R/L6-CE4	3,1	0,15	6°	0,09 - 0,24	±0,05	±0,10			☹	☹				☹	☹	☹						☹	☹
FX4.1-E410N020-CE4	4,1	0,2		0,10 - 0,32	±0,05	±0,10	☺		☹	☹				☹	☹	☹						☹	☹
FX4.1-E410R/L6-CE4	4,1	0,2	6°	0,10 - 0,26	±0,05	±0,10			☹	☹				☹	☹	☹						☹	☹
FX5.1-E510N025-CE4	5,1	0,25		0,12 - 0,35	±0,05	±0,10	☺		☹	☹				☹	☹	☹						☹	☹
FX5.1-E510R/L6-CE4	5,1	0,25	6°	0,12 - 0,28	±0,05	±0,10			☹	☹				☹	☹	☹						☹	☹
FX6.5-E650N030-CE4	6,5	0,3		0,12 - 0,40	±0,05	±0,10	☺		☹	☹				☹	☹	☹						☹	☹
FX6.5-E650R/L6-CE4	6,5	0,3	6°	0,12 - 0,32	±0,05	±0,10			☹	☹				☹	☹	☹						☹	☹
FX8.2-E820N040-CE4	8,2	0,4		0,15 - 0,45	±0,05	±0,10	☺		☹	☹				☹	☹	☹						☹	☹
FX9.7-E970N040-CE4	9,7	0,4		0,15 - 0,50	±0,05	±0,10	☺		☹	☹				☹	☹	☹						☹	☹
 FX3.1-E310N040-CD3	3,1	0,4		0,10 - 0,30	±0,05	±0,10	☺			☹				☹	☹								☹
FX4.1-E410N020-CD3	4,1	0,2		0,15 - 0,35	±0,05	±0,10	☺			☹				☹	☹								☹
FX4.1-E410N050-CD3	4,1	0,5		0,15 - 0,35	±0,05	±0,10	☺			☹				☹	☹								☹
 FX2.2-E220N015-CE6	2,2	0,15		0,05 - 0,15	±0,05	±0,10	☺		☹	☹				☹	☹	☹						☹	☹
FX2.2-E220R/L5-CE6	2,2	0,15	5°	0,05 - 0,15	±0,05	±0,10			☹	☹				☹	☹	☹						☹	☹
FX3.1-E310N020-CE6	3,1	0,2		0,06 - 0,25	±0,05	±0,10	☺		☹	☹				☹	☹	☹						☹	☹
FX3.1-E310R/L5-CE6	3,1	0,2	5°	0,06 - 0,20	±0,05	±0,10			☹	☹				☹	☹	☹						☹	☹
FX3.1-E310N040-CE6	3,1	0,4		0,06 - 0,25	±0,05	±0,10	☺		☹	☹				☹	☹	☹						☹	☹
FX4.1-E410N020-CE6	4,1	0,2		0,08 - 0,25	±0,05	±0,10	☺		☹	☹				☹	☹	☹						☹	☹
FX4.1-E410R/L5-CE6	4,1	0,2	5°	0,08 - 0,20	±0,05	±0,10			☹	☹				☹	☹	☹						☹	☹
FX4.1-E410N050-CE6	4,1	0,5		0,08 - 0,25	±0,05	±0,10	☺		☹	☹				☹	☹	☹						☹	☹
 FX2.2-E220N010-CK8	2,2	0,1		0,05 - 0,10	±0,05	±0,10											☺						
FX3.1-E310N015-CK8	3,1	0,15		0,05 - 0,15	±0,05	±0,10											☺						
FX4.1-E410N015-CK8	4,1	0,15		0,05 - 0,20	±0,05	±0,10											☺						

l_{Tol} = Repeat accuracy when changing indexable insert
 Radius tolerance r_{Tol} = ± 0.05

HC = Coated carbide
 HW = Uncoated carbide

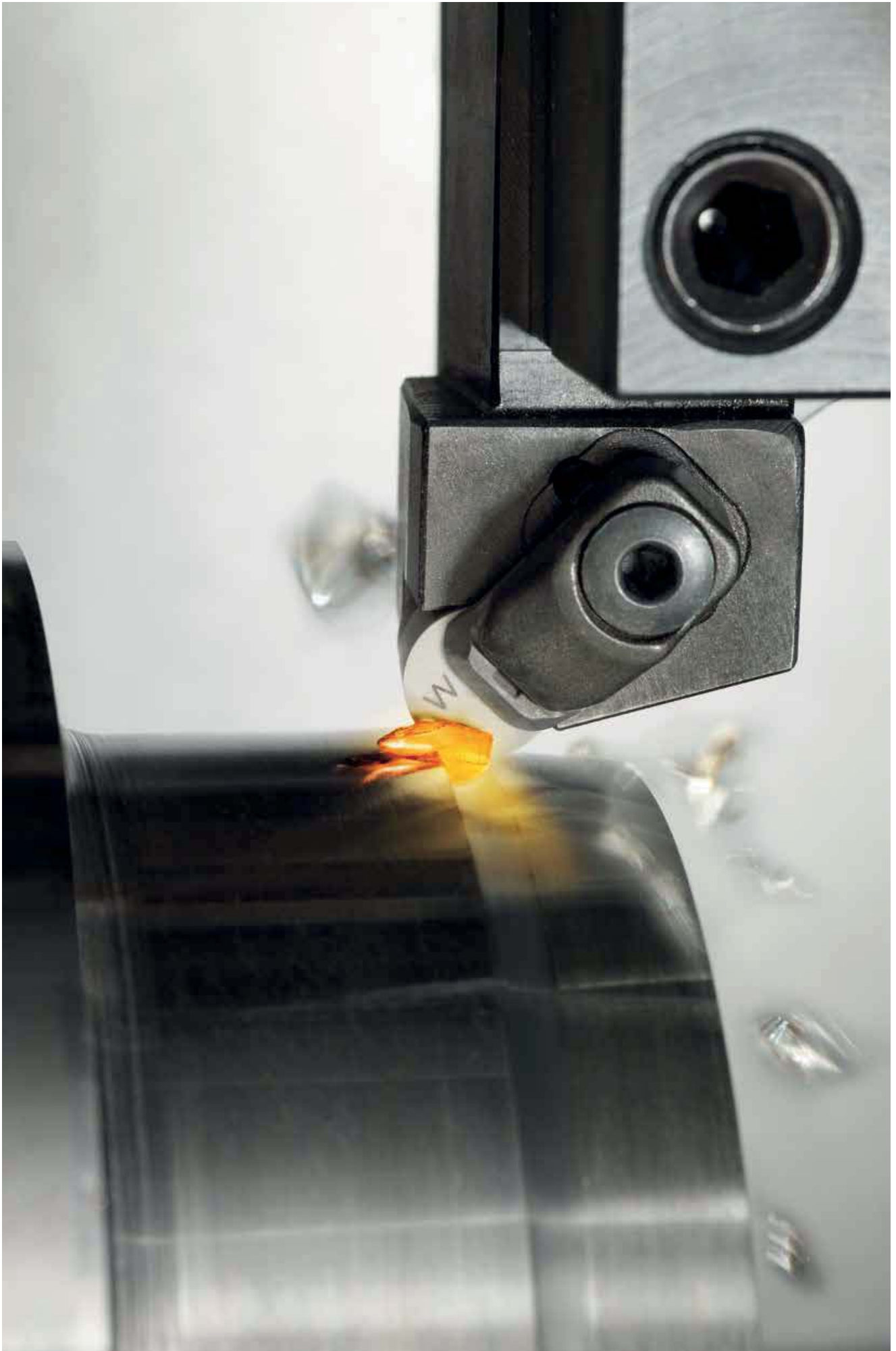

System overview of Walter Turn/Walter Capto™ – External machining

External toolholder for indexable inserts with a negative basic shape



Walter Turn rigid clamping system (D)

- The number one choice for machining short-chipping material such as cast iron
- Functionality is also maintained in "dirty environments", e.g. grey cast iron machining
- The number one choice for interrupted cuts thanks to extremely stable insert clamping
- Indexable insert and shim replaced using the same wrench
- Reinforced clamps with carbide shoe available for longer clamp service life



Walter Turn lever type clamping (P)

- Universal system with easy indexable insert replacement
- The number one choice for single-sided negative inserts, e.g. SNMM for heavy roughing
- Unobstructed chip evacuation and usable as an alternative to the rigid clamping system



Walter Turn wedge-type clamping system (M)

- For indexable inserts with a negative T basic shape
- Profiling is possible up to an angle of 22° with TNMG indexable inserts
- Insert that is frequently used when shaft machining with undercuts

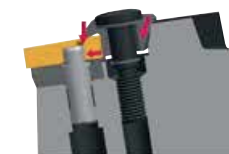

Walter Turn clamping system for ceramics (C)

- Special system for ceramic inserts without a hole
- Rigid clamping system with carbide shoe for a long service life
- First choice for machining high temperature alloys and cast iron material with ceramic inserts

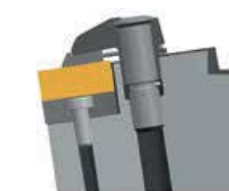

External toolholder for indexable inserts with a positive basic shape



Walter Turn screw clamping (S)

- For indexable inserts with positive basic shape with clearance angle of 5° and 7°
- The number one choice for use with low cutting pressures/small diameter shafts
- Fewer assembly parts are needed
- Torx Plus screw clamping for transmitting higher tightening torques
- Indexable insert and shim replaced using the same wrench



Walter Turn positive lever type clamping (P)

- For indexable inserts with positive V/R basic shape with clearance angle of 5° and 7°
- A high degree of shape accuracy is achieved on the component because of the large amount of pre-tension via the knee lever with V inserts
- No risk of the clamping screw slackening during machining caused by round insert distortion



Product range overview of Walter Turn tools
 External machining – Negative basic shape

Rigid-clamping system



Walter Turn



Walter Capto™

<p>95° NEW DCLN R/L h = 16–32 mm</p> <p>Shank tool: Page A-88 Page A 122*</p>	<p>107°30' DDHN R/L h = 20–25 mm</p> <p>Shank tool: Page A 88*</p>	<p>45° NEW DSDN N h = 16–32 mm</p> <p>Shank tool: Page A-90 Page A 126*</p>	<p>93° DVJN R/L h = 20–32 mm</p> <p>Shank tool: Page A 95* Page A 129*</p>
<p>75° DCBN R/L h = 25–32 mm</p> <p>Shank tool: Page A 85*</p>	<p>62°30' DDNN N h = 20–32 mm</p> <p>Shank tool: Page A 89*</p>	<p>75° DSBN / DSRN R/L h = 25–40 mm</p> <p>Shank tool: Page A 92* Page A 127*</p>	<p>117,5° NEW DVPN R/L h = 25–32 mm</p> <p>Shank tool: Page A-91</p>
<p>75° DCKN R/L h = 25–32 mm</p> <p>Shank tool: Page A 86*</p>	<p>93° DDUN R/L</p> <p>Shank tool: Page A 124*</p>	<p>75° DSKN R/L h = 25–32 mm</p> <p>Shank tool: Page A 93* Page A 128*</p>	<p>72°30' DVNN N h = 20–32 mm</p> <p>Shank tool: Page A 95*</p>
<p>93° DDJN R/L h = 20–32 mm</p> <p>Shank tool: Page A 87* Page A 123*</p>	<p>45° NEW DSSN R/L h = 16–32 mm</p> <p>Shank tool: Page A-89 Page A 125*</p>	<p>91° DTGN R/L h = 20–32 mm</p> <p>Shank tool: Page A 94*</p>	<p>95° NEW DWLN R/L h = 16–32 mm</p> <p>Shank tool: Page A-92 Page A 130*</p>

* The pages indicated in italics refer to the Walter General catalogue 2012.

Lever-type clamping system

Wedge-type clamping system



<p>95° NEW PCLN R/L h = 16–50 mm</p> <p>Shank tool: Page A-93 Walter Capto™ Page A 131*</p>	<p>93° PDJN R/L h = 16–32 mm</p> <p>Shank tool: Page A 100* Walter Capto™ Page A 132*</p>	<p>75° PSKN R/L h = 20–25 mm</p> <p>Shank tool: Page A 104* Walter Capto™ Page A 135*</p>	<p>93° MTJN R/L h = 20–32 mm</p> <p>Shank tool: Page A 106* Walter Capto™ Page A 136*</p>
<p>75° PCBN R/L h = 25–32 mm</p> <p>Shank tool: Page A 98*</p>	<p>45° NEW PSSN R/L h = 16–32 mm</p> <p>Shank tool: Page A-94 Walter Capto™ Page A 133*</p>	<p>91° NEW PTGN R/L h = 12–40 mm</p> <p>Shank tool: Page A-96</p>	
<p>75° PCKN R/L h = 25 mm</p> <p>Shank tool: Page A 99*</p>	<p>45° NEW PSDN N h = 12–40 mm</p> <p>Shank tool: Page A-95</p>	<p>91° NEW PTFN R/L h = 12–32 mm</p> <p>Shank tool: Page A-96</p>	
<p>45° PCSN R/L h = 25 mm</p> <p>Shank tool: Page A 99*</p>	<p>75° PSBN / PSRN R/L h = 20–50 mm</p> <p>Shank tool: Page A 103* Walter Capto™ Page A 134*</p>	<p>95° PWLN R/L h = 16–32 mm</p> <p>Shank tool: Page A 107* Walter Capto™ Page A 137*</p>	

Product range overview of Walter Turn tools

External machining – Positive basic shape



Screw clamping system/lever-type clamping system





<p>95°</p> <p>SCLC R/L</p> <p>h = 10–25 mm</p> <p>Shank tool: Page A 108*</p> <p> Page A 138*</p>	<p>SRSC R/L</p> <p>h = 20–40 mm</p> <p>Shank tool: Page A 113*</p> <p> Page A 142*</p>	<p>45°</p> <p>SSDC N</p> <p>h = 12–25 mm</p> <p>Shank tool: Page A 115*</p>	<p>107°30'</p> <p>SVHB / PVHB¹ R/L</p> <p>h = 16–32 mm</p> <p>Shank tool: Page A 117-118*</p> <p> Page A 146-147*</p>
<p>93°</p> <p>SDJC R/L</p> <p>h = 10–25 mm</p> <p>Shank tool: Page A 109*</p> <p> Page A 139*</p>	<p>PRGC¹ / PRSC¹ R/L</p> <p>h = 20–40 mm</p> <p>Shank tool: Page A 114*</p> <p> Page A 143*</p>	<p>75°</p> <p>SSBC / SSRC R/L</p> <p>h = 12–25 mm</p> <p>Shank tool: Page A 115*</p> <p> Page A 144*</p>	<p>72°30'</p> <p>SVVB / PVVB¹ N</p> <p>h = 12–32 mm</p> <p>Shank tool: Page A 119-120*</p> <p> Page A 148-149*</p>
<p>107°30'</p> <p>SDHC R/L</p> <p>h = 12–25 mm</p> <p>Shank tool: Page A 109*</p>	<p>SRDC / PRDC¹ N</p> <p>h = 12–50 mm</p> <p>Shank tool: Page A 111-112*</p> <p> Page A 140-144*</p>	<p>91°</p> <p>STGC R/L</p> <p>h = 12–25 mm</p> <p>Shank tool: Page A 116*</p> <p> Page A 145*</p>	<p>95°</p> <p>SWLC R/L</p> <p>h = 12–25 mm</p> <p>Shank tool: Page A 121*</p> <p> Page A 150*</p>
<p>62°30'</p> <p>SDNC N</p> <p>Shank tool: Page A 110*</p> <p> Page A 139*</p>	<p>45°</p> <p>SSDC R/L</p> <p>h = 16–25 mm</p> <p>Shank tool: Page A 115*</p>	<p>93°</p> <p>SVJB / PVJB¹ R/L</p> <p>h = 12–32 mm</p> <p>Shank tool: Page A 117-118*</p> <p> Page A 146-147*</p>	

¹ Walter Turn positive lever type clamping

* The pages indicated in italics refer to the Walter General catalogue 2012.

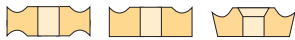
Product range overview of Walter Turn 45° Toolholders for turning/milling centres

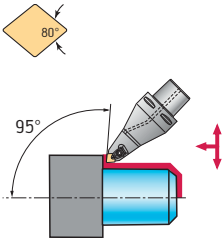
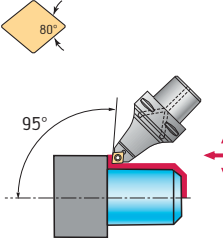
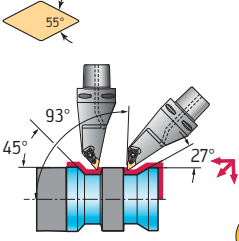
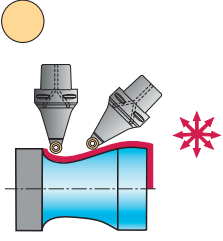
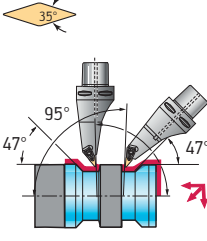
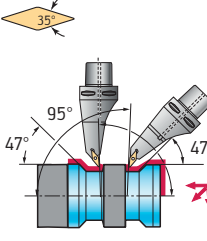

Rigid-clamping system	Screw clamping system
<p>Negative basic shape</p>  <p>Walter Capto™</p>	<p>Positive basic shape</p>  <p>Walter Capto™</p>
<p>95° DCMN N R/L</p>  <p>Walter Capto™ Page A 151*</p>	<p>95° SCMC N</p>  <p>Walter Capto™ Page A 154*</p>
<p>93° DDMN L R/L</p>  <p>Walter Capto™ Page A 152*</p>	<p>SRDC N</p>  <p>Walter Capto™ Page A 155*</p>
<p>95° DVMN L</p>  <p>Walter Capto™ Page A 153*</p>	<p>95° SVMB L</p>  <p>Walter Capto™ Page A 156*</p>

Product range overview for Walter Turn turning toolholders for ceramic inserts

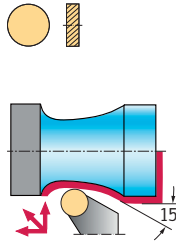
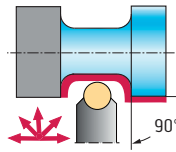
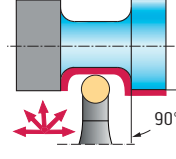
Rigid clamping system ¹	
<p>NEW CRSN</p>  <p>Shank tool Page A-97</p>	<p>NEW CRDN N</p>  <p>Shank tool Page A-98</p>
<p>NEW CRDC</p>  <p>Shank tool Page A-99</p>	

¹ For further information on Walter Turn turning toolholders for ceramic inserts with CN . . . 12 . . . / DN . . . 15 . . . / SN . . . 12 . . . see page A-137.

Walter Turn DCLN

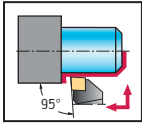

- Negative toolholder range
- External machining
- Rigid clamping system

Tool	Designation		h = h ₁ mm	b mm	f mm	l ₁ mm	l ₄ mm	γ	λ _S	Type	
κ = 95°	★ DCLNR/L1616H09		9	16	20	100	25	-6°	-6°	CN .. 0903 ..	
	★ DCLNR/L2020K09		9	20	25	125	25	-6°	-6°		
	★ DCLNR/L2525M09		9	25	32	150	25	-6°	-6°		
		DCLNR/L1616H12		12	16	20	100	32	-6°	-6°	CN .. 1204 ..
		DCLNR/L2020K12		12	20	25	125	32	-6°	-6°	
		DCLNR/L2525M12		12	25	32	150	32	-6°	-6°	
		DCLNR/L3225P12		12	32	32	170	32	-6°	-6°	CN .. 1606 ..
		DCLNR/L2525M16		16	25	32	150	39	-6°	-6°	
		DCLNR/L3225P16		16	32	32	170	39	-6°	-6°	
		DCLNR/L3232P16		16	32	40	170	39	-6°	-6°	CN .. 1906 ..
		DCLNR/L3232P19		19	32	40	170	44	-6°	-6°	

Measured with master insert CN .. 090304 / CN .. 120408 / CN .. 160612 / CN .. 190612

For information on the rake angle γ (for indexable inserts without geometry) and on the inclination angle λ_S, see page A 301 in the Walter General catalogue 2012.

Bodies and assembly parts are included in the scope of delivery.

Assembly parts	Type h mm	CN .. 0903 .. 16-25	CN .. 1204 .. 16	CN .. 1204 .. 20-32	CN .. 1606 .. 25-32	CN .. 1906 .. 32
	Shim	AP414-CN09	AP354-CN12	AP301-CN12	AP302-CN16	AP303-CN19
	Screw for shim	FS1462 (Torx 9IP)	FS1461 (Torx 15IP)	FS1461 (Torx 15IP)	FS1463 (Torx 20IP)	FS1463 (Torx 20IP)
	Clamp	PK240	PK241	PK241	PK242	PK243
	Clamp screw	FS1472 (Torx 9IP)	FS1473 (Torx 15IP)	FS1473 (Torx 15IP)	FS1474 (Torx 20IP)	FS1474 (Torx 20IP)
	Tightening torque	1,7 Nm	3,9 Nm	3,9 Nm	6,4 Nm	6,4 Nm
	Pressure spring	FS1469	FS1470	FS1470	FS1471	FS1471
	Pin	RS116	RS117	RS117	RS117	RS117
	Torx key	FS1466 (Torx 9IP)	FS1465 (Torx 15IP/SW 3,5)	FS1465 (Torx 15IP/SW 3,5)	FS1464 (Torx 20IP)	FS1464 (Torx 20IP)

Accessories	Type h mm	CN .. 0903 .. 16-25	CN .. 1204 .. 16-32	CN .. 1606 .. 25-32	CN .. 1906 .. 32
	Clamp set (standard mounting parts)	PK240 SET	PK241 SET	PK242 SET	PK243 SET
	Clamp set with carbide clamping plate		PK245 SET	PK246 SET	



★ New addition to range

Walter Turn DSSN

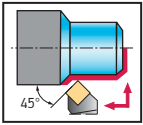

- Negative toolholder range
- External machining
- Rigid clamping system

Tool	Designation		h = h ₁ mm	b mm	f mm	f ₁ mm	l ₁ mm	l ₄ mm	l ₂₀ mm	γ	Type
κ = 45°	★ DSSNR/L1616H09	9	16	16	20	14	100	21	106,1	-8°	SN .. 0903 ..
	DSSNR/L2020K12	12	20	20	25	17	125	37	133,3	-8°	SN .. 1204 ..
	DSSNR/L2525M12	12	25	25	32	24	150	37	158,3	-8°	
	DSSNR/L3225P12	12	32	25	32	24	170	37	178,3	-8°	SN .. 1506 ..
	DSSNR/L2525M15	15	25	25	32	22	150	45	160,2	-8°	
	DSSNR/L3225P15	15	32	25	32	22	170	45	180,2	-8°	
	DSSNR/L3232P15	15	32	32	40	30	170	45	180,2	-8°	SN .. 1906 ..
	DSSNR/L3232P19	19	32	32	40	28	170	50	182,5	-8°	

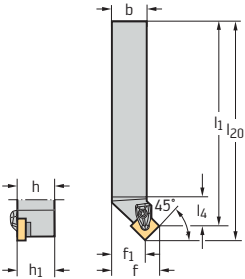

Measured with master insert SN .. 090304 / SN .. 120408 / SN .. 150612 / SN .. 190612.

For information on the rake angle γ (for indexable inserts without geometry) and on the inclination angle λ_s, see page A 301 in the Walter General catalogue 2012.

Bodies and assembly parts are included in the scope of delivery.

Assembly parts	Type h mm	SN .. 0903 .. 16	SN .. 1204 .. 20-32	SN .. 1506 .. 25-32	SN .. 1906 .. 32
	Shim	AP415-SN09	AP308-SN12	AP309-SN15	AP310-SN19
	Screw for shim	FS1462 (Torx 9IP)	FS1461 (Torx 15IP)	FS1463 (Torx 20IP)	FS1463 (Torx 20IP)
	Clamp	PK240	PK241	PK242	PK243
	Screw for clamp	FS1472 (Torx 9IP)	FS1473 (Torx 15IP)	FS1474 (Torx 20IP)	FS1474 (Torx 20IP)
	Tightening torque	1,7 Nm	3,9 Nm	6,4 Nm	6,4 Nm
	Pressure spring	FS1469	FS1470	FS1471	FS1471
	Pin	RS116	RS117	RS117	RS117
	Torx key	FS1466 (Torx 9IP)	FS1465 (Torx 15IP / SW 3,5)	FS1464 (Torx 20IP)	FS1464 (Torx 20IP)

Accessories	Type h mm	SN .. 0903 .. 16	SN .. 1204 .. 25-32	SN .. 1506 .. 25-32	SN .. 1906 .. 32
	Clamp set (standard mounting parts)	PK240 SET	PK241 SET	PK242 SET	PK243 SET
	Clamp set with carbide clamping plate		PK245 SET	PK246 SET	



★ New addition to range

Walter Turn DSDN

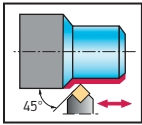

- Negative toolholder range
- External machining
- Rigid clamping system

Tool

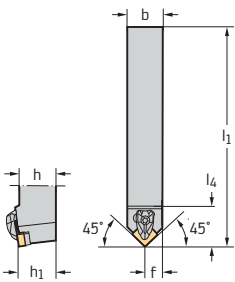
 $\kappa = 45^\circ$

Designation		$h = h_1$ mm	b mm	f mm	l_1 mm	l_4 mm	γ	λ_s	Type
★ DSDNN1616H09	9	16	16	8	100	28	-6°	-6°	SN .. 0903 ..
DSDNN2020K12	12	20	20	10	125	37	-6°	-6°	SN .. 1204 ..
DSDNN2525M12	12	25	25	13	150	37	-6°	-6°	
DSDNN3225P12	12	32	25	13	170	37	-6°	-6°	SN .. 1506 ..
DSDNN2525M15	15	25	25	13	150	45	-6°	-6°	
DSDNN3225P19	19	32	25	13	170	50	-6°	-6°	SN .. 1906 ..

Measured with master insert SN .. 090304 / SN .. 120408 / SN .. 150612 / SN .. 190612.

For information on the rake angle γ (for indexable inserts without geometry) and on the inclination angle λ_s , see page A 301 in the Walter General catalogue 2012.

Bodies and assembly parts are included in the scope of delivery.

Assembly parts

Type h mm	SN .. 0903 .. 16	SN .. 1204 .. 20-32	SN .. 1506 .. 25	SN .. 1906 .. 32
Shim	AP415-SN09	AP308-SN12	AP309-SN15	AP310-SN19
Screw for shim	FS1462 (Torx 9IP)	FS1461 (Torx 15IP)	FS1463 (Torx 20IP)	FS1463 (Torx 20IP)
Clamp	PK240	PK241	PK242	PK243
Screw for clamp Tightening torque	FS1472 (Torx 9IP) 1,7 Nm	FS1473 (Torx 15IP) 3,9 Nm	FS1474 (Torx 20IP) 6,4 Nm	FS1474 (Torx 20IP) 6,4 Nm
Pressure spring	FS1469	FS1470	FS1471	FS1471
Pin	RS116	RS117	RS117	RS117
Torx key	FS1466 (Torx 9IP)	FS1465 (Torx 15IP / SW 3,5)	FS1464 (Torx 20IP)	FS1464 (Torx 20IP)

Accessories

Type h mm	SN .. 0903 .. 16	SN .. 1204 .. 25-32	SN .. 1506 .. 25	SN .. 1906 .. 32
Clamp set (standard mounting parts)	PK240 SET	PK241 SET	PK242 SET	PK243 SET
Clamp set with carbide clamping plate		PK245 SET	PK246 SET	



★ New addition to range

Walter Turn DVPN

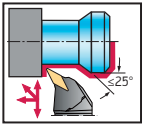

- Negative toolholder range
- External machining
- Rigid clamping system

Tool	Designation		h = h ₁ mm	b mm	f mm	l ₁ mm	l ₄ mm	γ	λ _S	Type
κ = 117,5°	★ DVPNR/L2525M16		16	25	32	150	39	-4°	-13°	VN .. 1604 ..
	★ DVPNR/L3225P16		16	32	25	32	170	-4°	-13°	

Measured with master insert VN .. 160408.

For information on the rake angle γ (for indexable inserts without geometry) and on the inclination angle λ_S, see page A 301 in the Walter General catalogue 2012. Bodies and assembly parts are included in the scope of delivery.

Assembly parts	Type h mm	VN .. 1604 .. 25-32
	Shim	AP312-VN16
	Screw for shim	FS1467 (Torx 15IP)
	Clamp	PK244
	Screw for clamp	FS1473 (Torx 15IP)
	Tightening torque	1,7 Nm
	Pressure spring	FS1470
	Pin	RS117
	Torx key	FS1465 (Torx 15IP / SW 3,5)

Accessories	Type h mm	VN .. 1604 .. 25
	Clamp set (standard mounting parts)	PK244 SET

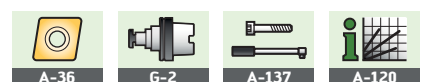

★ New addition to range

Walter Turn DWLN

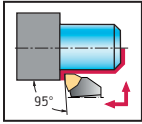

- Negative toolholder range
- External machining
- Rigid clamping system

Tool	Designation		h = h ₁ mm	b mm	f mm	l ₁ mm	l ₄ mm	γ	λ _S	Type
κ = 95° 	★ DWLNR/L1616H06	6	16	16	20	100	26	-6°	-6°	WN .. 0604 ..
	DWLNR/L2020K06	6	20	20	25	125	26	-6°	-6°	
	DWLNR/L2525M06	6	25	25	32	150	26	-6°	-6°	
	DWLNR/L3225P06	6	32	25	32	170	26	-6°	-6°	
	DWLNR/L2020K08	8	20	20	25	125	34	-6°	-6°	WN .. 0804 ..
	DWLNR/L2525M08	8	25	25	32	150	34	-6°	-6°	
	DWLNR/L3225P08	8	32	25	32	170	34	-6°	-6°	
	DWLNR/L2525M10	10	25	25	32	150	40	-6°	-6°	WN .. 1006 ..
	DWLNR/L3225P10	10	32	25	32	170	40	-6°	-6°	
	DWLNR/L3232P10	10	32	32	40	170	42	-6°	-6°	

Measured with master insert WN .. 060408 / WN .. 080408 / WN .. 100612.

For information on the rake angle γ (for indexable inserts without geometry) and on the inclination angle λ_S, see page A 301 in the Walter General catalogue 2012.

Bodies and assembly parts are included in the scope of delivery.

Assembly parts	Type h mm	WN .. 0604 .. 16-32	WN .. 0804 .. 20-32	WN .. 1006 .. 25-32
	Shim	AP306-WN06	AP307-WN08 r ≤ 1,6	AP311-WN10
	Screw for shim	FS1462 (Torx 9IP)	FS1461 (Torx 15IP)	FS1463 (Torx 20IP)
	Clamp	PK240	PK241	PK242
	Screw for clamp Tightening torque	FS1472 (Torx 9IP) 1,7 Nm	FS1473 (Torx 15IP) 3,9 Nm	FS1474 (Torx 20IP) 6,4 Nm
	Pressure spring	FS1469	FS1470	FS1471
	Pin	RS116	RS117	RS117
	Torx key	FS1466 (Torx 9IP)	FS1465 (Torx 15IP / SW 3,5)	FS1464 (Torx 20IP)

Accessories	Type h mm	WN .. 0604 .. 16-32	WN .. 0804 .. 20-32	WN .. 1006 .. 25-32
	Clamp set (standard mounting parts)	PK240 SET	PK241 SET	PK242 SET
	Clamp set with carbide clamping plate		PK245 SET	PK246 SET



★ New addition to range

Walter Turn

PCLN

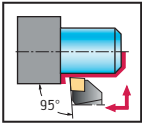

- Negative toolholder range
- External machining
- Lever type clamping

Tool	Designation		h = h ₁ mm	b mm	f mm	l ₁ mm	l ₄ mm	γ	λ _S	Type	
κ = 95°	★ PCLNR/L1616H09		9	16	20	100	24	-6°	-6°	CN .. 0903 ..	
	★ PCLNR/L2020K09		9	20	25	125	24	-6°	-6°		
	★ PCLNR/L2525M09		9	25	32	150	24	-6°	-6°		
		PCLNR/L1616H12		12	16	20	100	27	-6°	-6°	CN .. 1204 ..
		PCLNR/L2020K12		12	20	25	125	26	-6°	-6°	
		PCLNR/L2525M12		12	25	32	150	26	-6°	-6°	
		PCLNR/L3225P12		12	32	32	170	26	-6°	-6°	CN .. 1606 ..
		PCLNR/L2525M16		16	25	32	150	28	-6°	-6°	
		PCLNR/L3225P16		16	32	32	170	38	-6°	-6°	
		PCLNR/L3232P16		16	32	40	170	36	-6°	-6°	CN .. 1906 ..
		PCLNR/L3232P19		19	32	40	170	36	-6°	-6°	
		PCLNR/L4040S19		19	40	50	250	36	-6°	-6°	
		PCLNR/L4040S25		25	40	50	250	50	-6°	-6°	CN .. 2509 ..
		PCLNR/L5050T25		25	50	60	300	50	-6°	-6°	

Measured with master insert CN .. 090304 / CN .. 120408 / CN .. 160612 / CN .. 190612 / CN .. 250924.

For information on the rake angle γ (for indexable inserts without geometry) and on the inclination angle λ_S, see page A 301 in the Walter General catalogue 2012.

Bodies and assembly parts are included in the scope of delivery.

Assembly parts	Type h mm	CN .. 0903 .. 16-25	CN .. 1204 .. 16	CN .. 1204 .. 20-32	CN .. 1606 .. 25-32	CN .. 1906 .. 32-40	CN .. 2509 .. 40-50
	Shim	AP408-CN0908 r ≤ 0,8	AP134-CN1216 r ≤ 1,6	AP134-CN1216 r ≤ 1,6	AP135-CN1624 r ≤ 2,4	AP136-CN1924 r ≤ 2,4	AP192-CN2524 r ≤ 2,4
	Lever	KN101	KN121	KN102	KN104	KN106	KN107
	Clamping screw	FS351 (SW 2,5)	FS2129 (SW 3)	FS352 (SW 3)	FS354 (SW 3)	FS356 (SW 4)	FS357 (SW 5)
	Tightening torque	2,0 Nm	5,0 Nm	5,0 Nm	5,0 Nm	10,0 Nm	14,0 Nm
	Pipe pin	RS120	RS102	RS102	RS103	RS104	RS105
	Assembly plug	MD101	MD101	MD101	MD102	MD102	MD103
	Allen key	ISO2936-2,5 (SW 2,5)	ISO2936-3 (SW 3)	ISO2936-3 (SW 3)	ISO2936-3 (SW 3)	ISO2936-4 (SW 4)	ISO2936-5 (SW 5)

Accessories	Type h mm	CN .. 1204 .. 16-32	CN .. 1606 .. 25-32	CN .. 1906 .. 32-40
	Shim	AP134-CN1208 r ≤ 0,8	AP135-CN1616 r ≤ 1,6	AP136-CN1912 r ≤ 1,2



★ New addition to range

Walter Turn PSSN

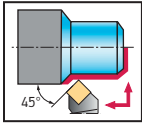

- Negative toolholder range
- External machining
- Lever type clamping

Tool	Designation		h = h ₁ mm	b mm	f mm	f ₁ mm	l ₁ mm	l ₄ mm	l ₂₀ mm	γ	Type
κ = 45°	★ PSSNR/L1616H09	9	16	16	20	14	100	22	106,1	-8°	SN .. 0903 ..
	PSSNR/L2020K12	12	20	20	25	17	125	28	133,3	-8°	SN .. 1204 ..
	PSSNR/L2525M12	12	25	25	32	24	150	28	158,3	-8°	
	PSSNR/L3225P12	12	32	25	32	24	170	29	178,3	-8°	SN .. 1506 ..
	PSSNR/L2525M15	15	25	25	32	22	150	32	160,2	-8°	
	PSSNR/L3232P15	15	32	32	40	30	170	32	180,2	-8°	
	PSSNR/L3232P19	19	32	32	40	28	170	38	182,5	-8°	SN .. 1906 ..

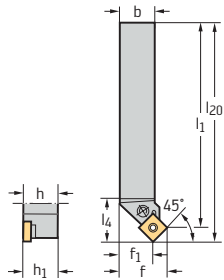

Measured with master insert SN .. 090304 .. / SN .. 120408 / SN .. 150612 / SN .. 190612.

For information on the rake angle γ (for indexable inserts without geometry) and on the inclination angle λ_s, see page A 301 in the Walter General catalogue 2012.

Bodies and assembly parts are included in the scope of delivery.

Assembly parts	Type h mm	SN .. 0903 .. 16	SN .. 1204 .. 20-32	SN .. 1506 .. 25-32	SN .. 1906 .. 32
	Shim	AP409-SN0908 r ≤ 0,8	AP141-SN1216 r ≤ 1,6	AP142-SN1524 r ≤ 2,4	AP143-SN1924 r ≤ 2,4
	Lever	KN101	KN102	KN104	KN106
	Clamping screw Tightening torque	FS351 (SW 2,5) 2,0 Nm	FS352 (SW 3) 5,0 Nm	FS354 (SW 3) 5,0 Nm	FS356 (SW 4) 10,0 Nm
	Shim pin	RS120	RS102	RS103	RS104
	Assembly plug	MD101	MD101	MD102	MD102
	Allen key	ISO2936-2,5 (SW 2,5)	ISO2936-3 (SW 3)	ISO2936-3 (SW 3)	ISO2936-4 (SW 4)

Accessories	Type h mm	SN .. 1204 .. 20-32	SN .. 1506 .. 25-32	SN .. 1906 .. 32	
	Shim		AP141-SN1208 r ≤ 0,8	AP142-SN1516 r ≤ 1,6	AP143-SN1912 r ≤ 1,2



★ New addition to range

Walter Turn PSDN

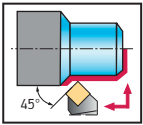

- Negative toolholder range
- External machining
- Lever type clamping

Tool	Designation		h = h ₁ mm	b mm	f mm	l ₁ mm	l ₄ mm	γ	λ _S	Type
	★ PSDNN1212F09	9	12	12	6	80	20	-6°	-6°	SN .. 0903 ..
	★ PSDNN1616H09	9	16	16	8	100	21	-6°	-6°	
	PSDNN2020K12	12	20	20	10	125	28	-6°	-6°	SN .. 1204 ..
	PSDNN2525M12	12	25	25	13	150	28	-6°	-6°	
	PSDNN3225P12	12	32	25	13	170	28	-6°	-6°	
	PSDNN3225P15	15	32	25	13	170	36	-6°	-6°	SN .. 1506 ..
	PSDNN3232P19	19	32	32	16	170	40	-6°	-6°	SN .. 1906 ..
	PSDNN4040S25	25	40	40	21	250	49	-6°	-6°	SN .. 2507 ..

Measured with master insert SN .. 090304. / SN .. 120408 / SN .. 150612 / SN .. 190612 / SN..250716.
 For information on the rake angle γ (for indexable inserts without geometry) and on the inclination angle λ_S, see page A 301 in the Walter General catalogue 2012.
 Bodies and assembly parts are included in the scope of delivery.

Assembly parts	Type h mm	SN .. 0903 ..	SN .. 0903 ..	SN .. 1204 ..	SN .. 1506 ..	SN .. 1906 ..	SN .. 2507 ..
		12	16	20-32	32	32	40
	Shim		AP409-SN0908 r ≤ 0,8	AP141-SN1216 r ≤ 1,6	AP142-SN1524 r ≤ 2,4	AP143-SN1924 r ≤ 2,4	AP144-SN2524 r ≤ 2,4
	Lever	KN126	KN101	KN102	KN104	KN106	KN107
	Clamping screw	FS2182 (SW 2)	FS351 (SW 2,5)	FS352 (SW 3)	FS354 (SW 3)	FS356 (SW 4)	FS357 (SW 5)
	Tightening torque	2,0 Nm	2,0 Nm	5,0 Nm	5,0 Nm	10,0 Nm	14,0 Nm
	Pipe pin		RS120	RS102	RS103	RS104	RS105
	Assembly plug		MD101	MD101	MD102	MD102	MD103
	Allen key	ISO2936-2 (SW 2)	ISO2936-2,5 (SW 2,5)	ISO2936-3 (SW 3)	ISO2936-3 (SW 3)	ISO2936-4 (SW 4)	ISO2936-5 (SW 5)

Accessories	Type h mm	SN .. 1204 ..	SN .. 1506 ..	SN .. 1906 ..	SN .. 2507 ..		
		20-32	32	32	40		
	Shim			AP141-SN1208 r ≤ 0,8	AP142-SN1516 r ≤ 1,6	AP143-SN1912 r ≤ 1,2	AP191-SN250924 r ≤ 2,4



★ New addition to range

Walter Turn PTGN/PTFN

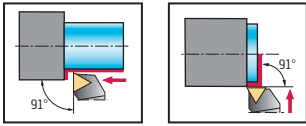

- Negative toolholder range
- External machining
- Lever type clamping

Tool	Designation		h = h ₁ mm	b mm	f mm	l ₁ mm	l ₄ mm	γ	λ _S	Type
κ = 91° 	★ PTGNR/L1212F11	11	12	12	16	80	16	-6°	-6°	TN .. 1103 ..
	★ PTGNR/L1616H11	11	16	16	20	100	16	-6°	-6°	TN .. 1604 ..
	PTGNR/L1616H16	16	16	16	20	100	20	-6°	-6°	
	PTGNR/L2020K16	16	20	20	25	125	20	-6°	-6°	
	PTGNR/L2525M16	16	25	25	32	150	20	-6°	-6°	
	PTGNR/L3225P16	16	32	25	32	170	20	-6°	-6°	
	PTGNR/L3232P22	22	32	32	40	170	26	-6°	-6°	TN .. 2204 ..
	PTGNR/L4040S27	27	40	40	50	250	34	-6°	-6°	TN .. 2706 ..
κ = 91° 	★ PTFNR/L1212F11	11	12	12	16	80	15	-6°	-6°	TN .. 1103 ..
	★ PTFNR/L1616H16	16	16	16	20	100	20	-6°	-6°	TN .. 1604 ..
	PTFNR/L2020K16	16	20	20	25	125	20	-6°	-6°	
	PTFNR/L2525M16	16	25	25	32	150	20	-6°	-6°	
	PTFNR/L3225P16	16	32	25	32	170	20	-6°	-6°	

Measured with master insert TN .. 110304 .. / TN .. 160408 / TN .. 220408.

For information on the rake angle γ (for indexable inserts without geometry) and on the inclination angle λ_S, see page A 301 in the Walter General catalogue 2012.

Bodies and assembly parts are included in the scope of delivery.

Assembly parts	Type h mm	TN .. 1103 .. 12-16	TN .. 1604 .. 16-32	TN .. 2204 .. 32	TN .. 2706 .. 40
	Shim		AP137-TN1616 r ≤ 1,6	AP138-TN2216 r ≤ 1,6	AP193-TN2716 r ≤ 1,6
	Lever	KN127	KN101	KN102	KN125
	Clamping screw Tightening torque	FS2182 (SW 2) 2,0 Nm	FS351 (SW 2,5) 2,0 Nm	FS352 (SW 3) 5,0 Nm	FS2156 (SW 3) 5 Nm
	Shim pin		RS101	RS102	RS103
	Assembly plug		MD101	MD101	MD102
	Allen key	ISO2936-2 (SW 2)	ISO2936-2,5 (SW 2,5)	ISO2936-3 (SW 3)	ISO2936-3 (SW 3)

Accessories	Type h mm	TN .. 1604 .. 16-32	TN .. 2204 .. 32
	Shim	AP137-TN1608 r ≤ 0,8	AP138-TN2208 r ≤ 0,8

★ New addition to range



Walter Turn CRSN

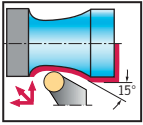

- Negative toolholder range
- External machining
- Rigid clamping system with carbide shoe

Tool	Designation		h = h ₁ mm	b mm	f mm	l ₁ mm	l ₄ mm	γ	λ _S	Type	
	★ CRSNR/L2525M12-ID	12	25	25	32	150	28	-6°	-6°	RNGN1207..	
	★ CRSNR/L3225P12-ID	12	32	25	32	170	28	-6°	-6°		
	★ CRSNR/L3232P15-ID	15	32	32	40	170	30	-6°	-6°		RNGN1507..
	★ CRSNR/L3232P19-ID	19	32	32	40	170	32	-6°	-6°		RNGN1907..

For information on the rake angle γ (for indexable inserts without geometry) and on the inclination angle λ_S, see page A 301 in the Walter General catalogue 2012. Bodies and assembly parts are included in the scope of delivery.

Assembly parts	Type h mm	RNGN1207.. 25-32	RNGN1507.. 32	RNGN1907.. 32
	Shim	AP418-RN1207	AP419-RN1507	AP420-RN1907
	Screw for shim Tightening torque	FS2241 (Torx 20) 5Nm	FS2242 (SW 2) 2Nm	FS2243 (SW 2,5) 3Nm
	Clamp with screw	PK258-SET (Torx 25IP)	PK258-SET (Torx 25IP)	PK258-SET (Torx 25IP)
	Carbide clamping plate	FK380	FK380	FK380
	Torx key for clamp	FS1592 (Torx 25IP)	FS1592 (Torx 25IP)	FS1592 (Torx 25IP)
	Torx key for support plate	FS256 (Torx 20)	ISO2936-2 (SW 2)	ISO2936-2,5 (SW 2,5)

Accessories	Type h mm	RNGN1207.. 25-32	RNGN1507.. 32	RNGN1907.. 32
	Clamp set with carbide clamping plate	PK259 SET	PK259 SET	PK259 SET

★ New addition to range



Walter Turn CRDN

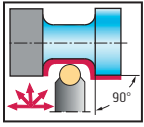

- Negative toolholder range
- External machining
- Rigid clamping system with carbide shoe

Tool	Designation		h = h ₁ mm	b mm	f mm	l ₁ mm	l ₄ mm	γ	Type
	★ CRDNN2525M12-ID	12	25	25	19	150	32	-8°	RNGN1207..
	★ CRDNN3225P12-ID	12	32	25	19	170	32	-8°	

For information on the rake angle γ (for indexable inserts without geometry) and on the inclination angle λ_s , see page A 301 in the Walter General catalogue 2012. Bodies and assembly parts are included in the scope of delivery.

Assembly parts	Type h mm	RNGN1207.. 25-32
	Shim	AP418-RN1207
	Screw for shim Tightening torque	FS2241 (Torx 20) 5Nm
	Clamp with screw	PK258-SET (Torx 25IP)
	Carbide clamping plate	FK380
	Torx key for clamp	FS1592 (Torx 25IP)
	Torx key for support plate	FS256 (Torx 20)

Accessories	Type h mm	RNGN1207.. 25
	Clamp set with carbide clamping plate	PK259 SET



★ New addition to range

Walter Turn CRDC

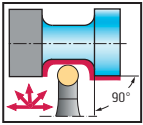

- Negative toolholder range
- External machining
- Rigid clamping system with carbide shoe

Tool	Designation		h = h ₁ mm	b mm	f mm	l ₁ mm	l ₄ mm	Type
	★ CRDCN3225P09-A	9	32	25	17	170	31	RC/P...0907..
	★ CRDCN3225P12-A	12	32	25	19	170	40	RC/P...1207..

For information on the rake angle γ (for indexable inserts without geometry) and on the inclination angle λ_s , see page A 301 in the Walter General catalogue 2012. Bodies and assembly parts are included in the scope of delivery.

Assembly parts	Type h mm	RC/P...0907..	RC/P...1207..
		32	32
	Shim	AP416-RC0907	AP417-RC1207
	Clamping sleeve	RS121	RS122
	Clamp with screw	PK257 SET	PK257 SET
	Screw for clamp Tightening torque	FS2240 (SW 4) 8 Nm	FS2240 (SW 4) 8 Nm
	Allen key	ISO2936-4 (SW 4)	ISO2936-4 (SW 4)

★ New addition to range

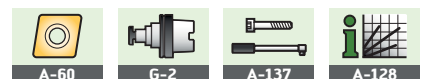



System overview of Walter Turn/Walter Capto™ – Internal machining

Boring bars for indexable inserts with a negative basic shape



Walter Turn rigid clamping system (D)

- The number one choice for machining short-chipping material such as cast iron
- Functionality is also maintained in “dirty environments”, e.g. grey cast iron machining
- The number one choice for interrupted cuts thanks to extremely stable insert clamping
- Indexable insert or shim replaced using the same wrench
- Reinforced clamps with carbide shoe available for longer clamp service life
- Internal coolant supply on all tools



Walter Turn lever-type clamping (P)

- Universal system with easy indexable insert replacement
- Number one choice for single-sided negative inserts, e.g. CNMM
- Number one choice when machining small bore diameters with negative inserts
- Unobstructed chip evacuation from the bore and therefore an alternative to the rigid clamping system



Boring bars for indexable inserts with a positive basic shape

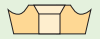

Walter Turn screw clamping (S)

- For indexable inserts with positive basic shape with clearance angle of 5° and 7°
- Machining of small hole diameters
- For use with low cutting pressures/long projection lengths
- Few assembly parts
- Torx Plus screw clamping for transmitting higher tightening torques
- Indexable insert or shim replaced using the same wrench
- Unobstructed chip evacuation from the bore
- Internal coolant supply on all tools
- Versions with steel and solid carbide shank



Walter Turn positive lever type clamping (P)

- For indexable inserts with positive V basic shape with clearance angle of 5° and 7°
- A high degree of shape accuracy is achieved on the component by means of the high degree of clamping via the lever type clamping
- For use with low cutting pressures/long projection lengths
- Unobstructed chip evacuation from the bore



Retaining sleeves for boring bars with cylindrical shank



Walter Turn boring bar holder AK 600

- Easy handling due to automatic tip height adjustment via a spring-loaded ball/flute detent
- Full round shank boring bars are completely enclosed for maximum stability
- Clamping of steel and solid carbide boring bars without flats (-R)



Product range overview of Walter Turn tools
 Internal machining – Negative basic shape

Rigid-clamping system		Lever-type clamping system	
<p>Walter Turn Walter Capto™</p>		<p>Walter Turn Walter Capto™</p>	
95° DCLN R/L $d_1 = 25-50 \text{ mm}$ <i>Boring bar: Page A 164*</i> <i>Page A 186*</i>	93° DVUN R/L $d_1 = 40 \text{ mm}$ <i>Boring bar: Page A 168*</i>	95° NEW PCLN R/L $d_1 = 16-40 \text{ mm}$ <i>Boring bar: Page A-104</i> <i>Page A 189*</i>	95° NEW PWLN R/L $d_1 = 20-32 \text{ mm}$ <i>Boring bar: Page A-108</i> <i>Page A 193*</i>
93° DDUN R/L $d_1 = 25-50 \text{ mm}$ <i>Boring bar: Page A 165*</i> <i>Page A 187*</i>	95° DWLN R/L $d_1 = 25-50 \text{ mm}$ <i>Boring bar: Page A 169*</i> <i>Page A 188*</i>	93° NEW PDUN R/L $d_1 = 25-40 \text{ mm}$ <i>Boring bar: Page A-105</i> <i>Page A 190*</i>	
75° DSKN R/L $d_1 = 25-40 \text{ mm}$ <i>Boring bar: Page A 166*</i>		75° NEW PSKN R/L $d_1 = 25-40 \text{ mm}$ <i>Boring bar: Page A-106</i> <i>Page A 191*</i>	
91° DTFN R/L $d_1 = 25-50 \text{ mm}$ <i>Boring bar: Page A 167*</i>		91° NEW PTFN N $d_1 = 16-40 \text{ mm}$ <i>Boring bar: Page A-107</i> <i>Page A 192*</i>	

* The pages indicated in italics refer to the Walter General catalogue 2012.

Product range overview of Walter Turn tools Internal machining – Positive basic shape



Screw clamping system/lever-type clamping system



Walter Turn



Walter Capto™

<p>95° NEW SCLC R/L d₁ = 08–32 mm</p> <p>Boring bar: Page A-109 Walter Capto Page A 194*</p>	<p>75° SSKC R/L d₁ = 16–32 mm</p> <p>Boring bar: Page A 179*</p>	<p>95° SWLC R/L d₁ = 10–32 mm</p> <p>Boring bar: Page A 185* Walter Capto Page A 199*</p>
<p>93° NEW SDUC R/L d₁ = 10–32 mm</p> <p>Boring bar: Page A-110 Walter Capto Page A 195*</p>	<p>91° NEW STFC R/L d₁ = 06–32 mm</p> <p>Boring bar: Page A-111 Walter Capto Page A 196*</p>	
<p>93° SDUC R/L-X d₁ = 16–32 mm</p> <p>Boring bar: Page A 177*</p>	<p>93° SVUB / PVUB¹ R/L d₁ = 16–40 mm</p> <p>Boring bar: Page A 181-182*</p>	
<p>107°30' SDQC R/L d₁ = 12–25 mm</p> <p>Boring bar: Page A 178*</p>	<p>107°30' SVQB / PVQB¹ R/L d₁ = 16–40 mm</p> <p>Boring bar: Page A 183-184* Walter Capto Page A 197-198*</p>	

¹ Walter Turn positive lever type clamping

Walter Turn

A ... – PCLN

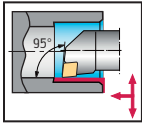

- Negative toolholder range
- Internal machining
- Lever type clamping

Tool	Designation		D _{min} mm	d ₁ mm	f mm	h mm	l ₁ mm	γ	λ _S	Type	
											κ = 95°
	★ A16R-PCLNR/L09		9	20	11	15	200	-6°	-13°	CN .. 0903 ..	
	★ A20S-PCLNR/L09		9	25	13	18	250	-6°	-11°		
	★ A25T-PCLNR/L09		9	32	17	23	300	-6°	-11°		
	★ A25T-PCLNR/L12			12	32	17	23	300	-6°	-10°	CN .. 1204 ..
	★ A32T-PCLNR/L12		12	40	22	30	300	-6°	-11°		
	★ A40T-PCLNR/L12		12	50	27	37	300	-6°	-10°		
	★ A32T-PCLNR/L16			16	55	22	30	300	-6°	-10°	CN .. 1606 ..
	★ A40T-PCLNR/L16		16	58	27	37	300	-6°	-10°		

For information on the rake angle γ (for indexable inserts without geometry) and on the inclination angle λ_S, see page A 301 in the Walter General catalogue 2012.

Measured with master insert CN .. 090304 .. / CN .. 120408 / CN .. 160612.

Bodies and assembly parts are included in the scope of delivery.

Assembly parts	Type D _{min} mm	CN .. 0903 .. 20-32	CN .. 1204 .. 32	CN .. 1204 .. 40	CN .. 1204 .. 50	CN .. 1606 .. 55-58
	Shim			AP134-CN1216 r ≤ 1,6	AP134-CN1216 r ≤ 1,6	AP135-CN1624 r ≤ 2,4
	Lever	KN126	KN128	KN121	KN102	KN104
	Clamping screw Tightening torque	FS2182 (SW 2) 2,0 Nm	FS332 (SW 2,5) 2,5 Nm	FS2129 (SW 3) 5,0 Nm	FS352 (SW 3) 5,0 Nm	FS354 (SW 3) 5,0 Nm
	Shim pin			RS102	RS102	RS103
	Assembly plug			MD101	MD101	MD102
	Allen key	ISO2936-2 (SW 2)	ISO2936-2,5 (SW 2,5)	ISO2936-3 (SW 3)	ISO2936-3 (SW 3)	ISO2936-3 (SW 3)

Accessories	Type D _{min} mm	CN .. 1204 .. 40-50	CN .. 1606 .. 55-58
	Shim	AP134-CN1208 r ≤ 0,8	AP135-CN1616 r ≤ 1,6

★ New addition to range



Walter Turn A ... – PDUN

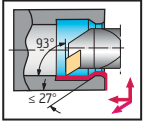

- Negative toolholder range
- Internal machining
- Lever type clamping

Tool			D_{min} mm	d_1 mm	f mm	h mm	l_1 mm	γ	λ_s	Type	
$\kappa = 93^\circ$		★ A25T-PDUNR/L11	11	32	25	17	23	300	-6°	-11°	DN .. 1104 ..
		★ A32T-PDUNR/L11	11	40	32	22	30	300	-6°	-10°	
		★ A40T-PDUNR/L11	11	50	40	27	37	300	-6°	-11°	
		★ A32T-PDUNR/L15	15	40	32	22	30	300	-6°	-12°	DN .. 1506 ..
		★ A40T-PDUNR/L15	15	50	40	27	37	300	-6°	-11°	

For information on the rake angle γ (for indexable inserts without geometry) and on the inclination angle λ_s , see page A 301 in the Walter General catalogue 2012.
Measured with master insert DN .. 110408 / DN .. 150608.
Bodies and assembly parts are included in the scope of delivery.

Assembly parts	Type D_{min} mm	DN .. 1104 .. 32	DN .. 1104 .. 40-50	DN .. 1506 .. 40-50
	Shim		AP171-DN1112 $r \leq 1,2$	AP145-DN1516 $r \leq 1,6$
	Lever	KN120	KN119	KN103
	Shim pin		RS101	RS102
	Clamping screw Tightening torque	FS905 (SW 2) 2,0 Nm	FS351 (SW 2,5) 2,0 Nm	FS355 (SW 3) 5,0 Nm
	Assembly plug		MD101	MD101
	Allen key	ISO2936-2 (SW 2)	ISO2936-2,5 (SW 2,5)	ISO2936-3 (SW 3)

Accessories	Type D_{min} mm	DN .. 1104 .. 40-50	DN .. 1506 .. 40-50
	Shim		AP171-DN1108 $r \leq 0,8$
	Shim for DN .. 1504 .. for		AP357-DN1516 $r \leq 0,8 / 1,6$



★ New addition to range

Walter Turn

A ... – PSKN

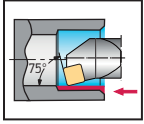

- Negative toolholder range
- Internal machining
- Lever type clamping

Tool			D_{min} mm	d_1 mm	f mm	h mm	l_1 mm	γ	λ_s	Type
$\kappa = 75^\circ$ 	★ A25T-PSKNR/L12	12	32	25	17	23	300	-6°	-11°	SN .. 1204 ..
	★ A32T-PSKNR/L12	12	40	32	22	30	300	-6°	-10°	
	★ A40T-PSKNR/L12	12	50	40	27	37	300	-6°	-10°	

For information on the rake angle γ (for indexable inserts without geometry) and on the inclination angle λ_s , see page A 301 in the Walter General catalogue 2012.

Measured with master insert SN .. 120408.

Bodies and assembly parts are included in the scope of delivery.

Assembly parts	Type D_{min} mm	SN .. 1204 .. 32	SN .. 1204 .. 40	SN .. 1204 .. 50
	Shim		AP141-SN1216 $r \leq 1,6$	AP141-SN1216 $r \leq 1,6$
	Lever	KN128	KN121	KN102
	Clamping screw Tightening torque	FS332 (SW 2,5) 2,5 Nm	FS2129 (SW 3) 5,0 Nm	FS352 (SW 3) 5,0 Nm
	Shim pin		RS102	RS102
	Assembly plug		MD101	MD101
	Allen key	ISO2936-2,5 (SW 2,5)	ISO2936-3 (SW 3)	ISO2936-3 (SW 3)

Accessories	Type D_{min} mm	SN .. 1204 .. 40
	Shim	AP141-SN1208 $r \leq 0,8$

★ New addition to range



Walter Turn A ... – PTFN

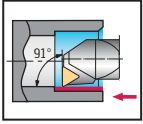

- Negative toolholder range
- Internal machining
- Lever type clamping

Tool			D_{min} mm	d_1 mm	f mm	h mm	l_1 mm	γ	λ_s	Type
$\kappa = 91^\circ$ 	★ A16R-PTFNR/L11		11	20	11	15	200	-6°	-14°	TN .. 1103 ..
	★ A20S-PTFNR/L11		11	25	13	18	250	-6°	-12°	
	★ A25T-PTFNR/L11		11	32	17	23	300	-6°	-10°	
	★ A25T-PTFNR/L16		16	32	17	23	300	-6°	-13°	TN .. 1604 ..
	★ A32T-PTFNR/L16		16	50	22	30	300	-6°	-12°	TN .. 2204 ..
	★ A40T-PTFNR/L22		22	50	27	37	300	-6°	-11°	

For information on the rake angle γ (for indexable inserts without geometry) and on the inclination angle λ_s , see page A 301 in the Walter General catalogue 2012.
 Measured with master insert TN .. 110304 .. / TN .. 160408 / TN .. 220408.
 Bodies and assembly parts are included in the scope of delivery.

Assembly parts	Type D_{min} mm	TN .. 1103 .. 20-32	TN .. 1604 .. 32-50	TN .. 2204 .. 50
	Shim		AP137-TN1616 $r \leq 1,6$	AP138-TN2216 $r \leq 1,6$
	Lever	KN127	KN101	KN102
	Clamping screw Tightening torque	FS2182 (SW 2) 2,0 Nm	FS351 (SW 2,5) 2,0 Nm	FS352 (SW 3) 5,0 Nm
	Shim pin		RS101	RS102
	Assembly plug		MD101	MD101
	Allen key	ISO2936-2 (SW 2)	ISO2936-2,5 (SW 2,5)	ISO2936-3 (SW 3)

Accessories	Type D_{min} mm	TN .. 1604 .. 32-50	TN .. 2204 .. 50
	Shim	AP137-TN1608 $r \leq 0,8$	AP138-TN2208 $r \leq 0,8$



★ New addition to range

Walter Turn

A ... – PWLN

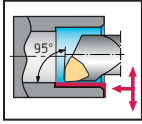

- Negative toolholder range
- Internal machining
- Lever type clamping

Tool	Designation		D_{min} mm	d_1 mm	f mm	h mm	l_1 mm	γ	λ_s	Type
$\kappa = 95^\circ$	★ A20S-PWLN/L06	6	25	20	13	18	250	-6°	-15°	WN .. 0604 ..
	★ A25T-PWLN/L06	6	32	25	17	23	300	-6°	-12°	
	★ A32T-PWLN/L06	6	40	32	22	30	300	-6°	-12°	
	★ A25T-PWLN/L08	8	32	25	17	23	300	-6°	-10°	WN .. 0804 ..
	★ A32T-PWLN/L08	8	40	32	22	30	300	-6°	-10°	

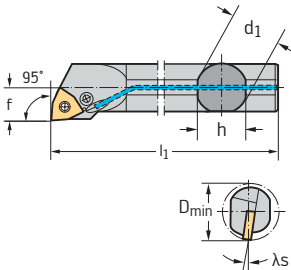

For information on the rake angle γ (for indexable inserts without geometry) and on the inclination angle λ_s , see page A 301 in the Walter General catalogue 2012.

Measured with master insert WN .. 060408 / WN .. 080408 / WN .. 100612.

Bodies and assembly parts are included in the scope of delivery.

Assembly parts	Type D_{min} mm	WN .. 0604 .. 25-32	WN .. 0604 .. 40	WN .. 0804 .. 32	WN .. 0804 .. 40
	Shim		AP172-WN0612 $r \leq 1,2$		AP170-WN0816 $r \leq 1,6$
	Lever	KN108	KN101	KN128	KN102
	Shim pin		RS101		RS102
	Clamping screw Tightening torque	FS331 (SW 2) 2,0 Nm	FS351 (SW 2,5) 2,0 Nm	FS332 (SW 2,5) 2,5 Nm	FS352 (SW 3) 5,0 Nm
	Assembly plug		MD101		MD101
	Allen key	ISO2936-2 (SW 2)	ISO2936-2,5 (SW 2,5)	ISO2936-2,5 (SW 2,5)	ISO2936-3 (SW 3)

Accessories	Type D_{min} mm	WN .. 0804 .. 40			
	Shim				AP170-WN0808 $r \leq 0,8$

★ New addition to range



Walter Turn

A ... – SCLC / E ... – SCLC

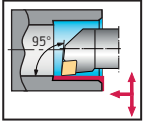

- Positive toolholder range
- Internal machining
- Screw clamping

Tool	Designation		D_{min} mm	d_1 mm	f mm	h mm	l_1 mm	γ	λ_s	Type	
$\kappa = 95^\circ$ 	A08H-SCLCR/L06	6	10	8	5	7	100	0°	-14°	CC...0602..	
	A10K-SCLCR/L06	6	12	10	6	9	125	0°	-11°		
	A12M-SCLCR/L06	6	16	12	9	11	150	0°	-7°		
	$\kappa = 95^\circ$ 	A16R-SCLCR/L09	9	20	16	11	15	200	0°	-8,5°	CC...09T3..
		A20S-SCLCR/L09	9	25	20	13	18	250	0°	-6°	
		A25T-SCLCR/L09	9	32	25	17	23	300	0°	-3,5°	CC...1204..
		A25T-SCLCR/L12	12	32	25	17	23	300	0°	-4,5°	
A32T-SCLCR/L12		12	40	32	22	30	300	0°	-10°		
$\kappa = 95^\circ$ 	A08H-SCLCR/L06-R	6	10	8	5		100	0°	-14°	CC...0602..	
	E08K-SCLCR/L06-R	6	10	8	5		125	0°	-10°		
	A10K-SCLCR/L06-R	6	12	10	6		150	0°	-7°		
	E10M-SCLCR/L06-R	6	12	10	6		180	0°	-3°		
	A12M-SCLCR/L06-R	6	16	12	9		200	0°	-8,5°		
	$\kappa = 95^\circ$ 	A16R-SCLCR/L09-R	9	20	16	11		200	0°	0°	CC...09T3..
		E16R-SCLCR/L09-R	9	20	16	11		250	0°	-6°	
		A20S-SCLCR/L09-R	9	25	20	13		300	0°	-4,5°	
		★ E20S-SCLCR/L09-R	9	25	20	13					
		★ E25T-SCLCR/L09-R	9	32	25	17					

For information on the rake angle γ (for indexable inserts without geometry) and on the inclination angle λ_s , see page A 301 in the Walter General catalogue 2012.

Measured with master insert CC...060204 / CC...09T308 / CC...120408.

Bodies and assembly parts are included in the scope of delivery.

A = Boring bar in steel version

E = Boring bar made of solid carbide

Assembly parts	Type D_{min} mm	CC...0602.. 10-16	CC...09T3.. 20-25	CC...09T3.. 32	CC...1204.. 32	CC...1204.. 40
	Clamping screw for insert Tightening torque	FS2066 (Torx 7IP) 0,9 Nm	FS2062 (Torx 15IP) 3,0 Nm	FS2063 (Torx 15IP) 3,0 Nm	FS2064 (Torx 15IP) 3,0 Nm	FS2065 (Torx 15IP) 3,0 Nm
	Shim					AP314-CC1212 $r \leq 1,2$
	Screw for shim					FS2069 (SW 4)
	Torx key	FS1490 (Torx 7IP)	FS1465 (Torx 15IP / SW 3,5)	FS1465 (Torx 15IP / SW 3,5)	FS1496 (Torx 15IP / SW 4)	FS1496 (Torx 15IP / SW 4)

Accessories	d_1 mm	
	8	K600.08.28.066
	10	K600.10.28.086
	12	K600.12.38.086
	16	K600.16.40.137
	20	K600.20.40.137
	25	K600.25.44.137
	32	K600.32.44.137

★ New addition to range



Walter Turn

A ... – SDUC / E ... – SDUC

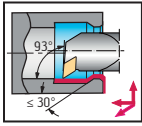

- Positive toolholder range
- Internal machining
- Screw clamping

Tool

	Designation		D_{min} mm	d_1 mm	f mm	h mm	l_1 mm	γ	λ_s	Type	
$\kappa = 93^\circ$ 	A10K-SDUCR/L07	7	13	10	7	9	125	0°	-9°	DC ... 0702 ...	
	A12M-SDUCR/L07	7	16	12	9	11	150	0°	$-6,5^\circ$		
	A16R-SDUCR/L07	7	20	16	11	15	200	0°	-4°		
	$\kappa = 93^\circ$ 	A20S-SDUCR/L11	11	25	20	13	18	250	0°	-6°	DC ... 11T3 ...
		A25T-SDUCR/L11	11	32	25	17	23	300	0°	-3°	
		★ A32T-SDUCR/L11	11	40	32	22	30	300	0°	-3°	
$\kappa = 93^\circ$ 	A10K-SDUCR/L07-R	7	15	10	7		125	0°	-7°	DC ... 0702 ...	
	E10M-SDUCR/L07-R	7	15	10	9		150	0°	-5°		
	A12M-SDUCR/L07-R	7	18	12	9		150	0°	-5°		
	E12Q-SDUCR/L07-R	7	18	12	11		180	0°	-5°		
	A16R-SDUCR/L07-R	7	20	16	11		200	0°	-4°		
	$\kappa = 93^\circ$ 	E16R-SDUCR/L07-R	7	22	16	13		200	0°	-5°	DC ... 11T3 ...
		A20S-SDUCR/L11-R	11	25	20	13		250	0°	-6°	
		★ E20S-SDUCR/L11-R	11	25	20	13		250	0°	-6°	
		★ E25T-SDUCR/L11-R	11	32	25	17		300	0°	-3°	

For information on the rake angle γ (for indexable inserts without geometry) and on the inclination angle λ_s , see page A 301 in the Walter General catalogue 2012.

Measured with master insert DC ... 070204 / DC ... 11T308.

Bodies and assembly parts are included in the scope of delivery.

A = Boring bar in steel version

E = Boring bar made of solid carbide

Assembly parts

Type	DC ... 0702 ... 13-22	DC ... 11T3 ... 25	DC ... 11T3 ... 32
 Clamping screw for insert Tightening torque	FS2061 (Torx 7IP) 0,9 Nm	FS2062 (Torx 15IP) 3,0 Nm	FS2063 (Torx 15IP) 3,0 Nm
 Torx key	FS1490 (Torx 7IP)	FS1465 (Torx 15IP / SW 3,5)	FS1465 (Torx 15IP / SW 3,5)

Accessories

	d_1 mm		
 Coolant adaptor	8	K600.08.28.066	
	10	K600.10.28.086	
	12	K600.12.38.086	
	16	K600.16.40.137	
	20	K600.20.40.137	
	25	K600.25.44.137	
	32	K600.32.44.137	



★ New addition to range

Walter Turn

A ... – STFC / E ... – STFC

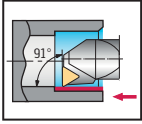

- Positive toolholder range
- Internal machining
- Screw clamping

Tool	Designation		D_{min} mm	d_1 mm	f mm	h mm	l_1 mm	γ	λ_s	Type
$\kappa = 91^\circ$ 	A06F-STFCR/L06	6	8,5	6	5	5	80	0°	-12°	TC...06T1...
	A08H-STFCR/L06	6	11	8	6	5	100	0°	-10°	
	A10K-STFCR/L09	9	13	10	7	9	125	0°	-9°	TC...0902...
	A12M-STFCR/L11	11	16	12	9	11	150	0°	-6,5°	
	A16R-STFCR/L11	11	20	16	11	15	200	0°	-4,5°	TC...1102...
	A20S-STFCR/L11	11	25	20	13	18	250	0°	-3°	
	A25T-STFCR/L16	16	32	25	17	23	300	0°	-3°	TC...16T3...
A32T-STFCR/L16	16	40	32	22	30	300	0°	-7°		
$\kappa = 91^\circ$ 	A06F-STFCR/L06-R	6	8,5	6	5		80	0°	-10°	TC...06T1...
	E06H-STFCR/L06-R	6	8,5	6	5		100	0°	-10°	
	A08H-STFCR/L06-R	6	11	8	6		100	0°	-6°	
	E08K-STFCR/L06-R	6	11	8	6		125	0°	-10°	TC...0902...
	A10K-STFCR/L09-R	9	13	10	7		125	0°	-8°	
	E10M-STFCR/L09-R	9	13	10	7		150	0°	-8°	
	E12Q-STFCR/L09-R	9	16	12	9		180	0°	-6°	TC...1102...
	A12M-STFCR/L11-R	11	16	12	9		150	0°	-6,5°	
	A16R-STFCR/L11-R	11	20	16	11		200	0°	-4,5°	
	E16R-STFCR/L11-R	11	20	16	11		200	0°	-4°	TC...16T3...
	★ E20S-STFCR/L11-R	11	25	20	13		250	0°	-3°	
	★ E25T-STFCR/L16-R	16	32	25	17		300	0°	-3°	

For information on the rake angle γ (for indexable inserts without geometry) and on the inclination angle λ_s , see page A 301 in the Walter General catalogue 2012.

Measured with master insert TC...06T102 / TC...090204 / TC...110204 / TC...16T308.

Bodies and assembly parts are included in the scope of delivery. A = Boring bar in steel version/E = Boring bar made of solid carbide

Assembly parts	Type D_{min} mm	TC...06T1...	TC...06T1...	TC...0902...	TC...1102...	TC...1102...	TC...16T3...	TC...16T3...
		8,5	11	13-16	16	20-25	32	40
Clamping screw for insert		FS2147 (Torx 6 IP)	FS2148 (Torx 6 IP)	FS2149 (Torx 7 IP)	FS2067 (Torx 7IP)	FS2061 (Torx 7IP)	FS2063 (Torx 15IP)	FS2060 (Torx 15 IP)
Tightening torque		0,5 Nm	0,5 Nm	0,9 Nm	0,9 Nm	0,9 Nm	3,0 Nm	3,0 Nm
Shim								AP317-TC1612
for								$r \leq 1,2$
Screw for shim								FS2068 (SW 3,5)
Torx key		FS2146 (Torx 6IP)	FS2146 (Torx 6IP)	FS1490 (Torx 7IP)	FS1490 (Torx 7IP)	FS1490 (Torx 7IP)	FS1465 (Torx 15IP / SW 3,5)	FS1465 (Torx 15IP / SW 3,5)

Accessories	d_1 mm	
	8	K600.08.28.066
	10	K600.10.28.086
	12	K600.12.38.086
	16	K600.16.40.137
	20	K600.20.40.137
	25	K600.25.44.137
	32	K600.32.44.137



★ New addition to range

Walter Cut system overview

Tool families for grooving

NEW

G1011 monoblock tool

- For GX cutting inserts
- For grooving, parting off and longitudinal turning
- For all types of lathe
- Different cutting depths available
- Clamped with screws
- Access to the screw from above and below.
- Extremely easy tool handling even in inverted use
- Excellent chip evacuation by means of low head height



XLDE monoblock tool for parting off

- Simple tool handling because of angled access clamping screw
- Shank sizes 10 x 10 mm – 20 x 20 mm for use on sliding head machines and multi-spindle machines
- Quick cutting insert replacement time through possibility of insert replacement in the machine
- For parting diameters of up to 32 mm



G1042 deep parting blade

- Cost-effective, double-edged parting off solution with cutting depth of up to 23 mm
- Single-edged parting off solution with cutting depth of up to 60 mm
- Stable 4-point clamping
- Simple tool handling
- Defined clamping force
- One tool system for single and double-edged cutting inserts



G1041 reinforced parting blade

- Maximum process reliability due to stable tool design
- Maximum cost efficiency due to double-sided cutting inserts for parting off operation
- Optimum cutting insert retention due to Torx Plus screw clamping and insert seat design
- Little tool deflection due to reinforced tool body
- Longer tool life due to reduction in micro-vibration



Walter Cut Modular

- Maximum grooving flexibility
- Small inventory
- Short set-up times
- For GX, FX and LX cutting inserts
- 3 different parting systems can be used
- 900 possible combinations



G1111 monoblock tool for axial grooving

- For GX24 cutting inserts
- For grooving and recessing
- Excellent chip evacuation by means of low tool head height
- Access to the screw from above and below; Extremely easy tool handling even in inverted use

Tool families for grooving



G15 . . monoblock tool for shallow cutting depths

- For GX cutting inserts
- For grooving, groove-turning and recess turning
- Cutting depth of up to 6 mm
- Groove widths of 2–6 mm in one and the same tool
- Excellent chip evacuation by means of low tool head height
- Access to the screw from above and below; Extremely easy tool handling even in inverted use



NEW

G2012 monoblock tool with internal coolant supply

- For SX cutting inserts
- With internal coolant supply on all tools
- For grooving and parting off
- For all types of lathe
- Different cutting depths available
- Stable self-clamping system by top clamp
- Connection to high-pressure cooling is possible



NEW

G2042 deep parting blade

- Cost-effective, single-edged parting off solution for cutting depth up to 80 mm
- Stable self-clamping system by top clamp
- Simple tool handling
- Special deep parting blade for SX cutting inserts
- Available in neutral and reinforced right-/left-hand versions

Product range overview of Walter Cut grooving tools

Parting off/grooving			
GX system		SX/FX system	
XLDE s = 1,5–3 mm T _{max} = 16 mm <i>Page A 210*</i>	NCAE / NCBE s = 2–8 mm T _{max} = 21 mm Shank tool: <i>Page A 218*</i> <i>Page A 250*</i>	G1041 s = 1,5–4 mm T _{max} = 32 mm <i>Page A 214*</i>	 G2012 s = 3–4 mm T _{max} = 33 mm Page A-118
XLDE-C s = 1,5–3 mm T _{max} = 16 mm <i>Page A 211*</i>	NCLE s = 2–8 mm T _{max} = 21 mm Shank tool: <i>Page A 220*</i> <i>Page A 254*</i>	G1041-C s = 1,5–4 mm T _{max} = 32 mm <i>Page A 215*</i>	 G2042 s = 2–6 mm T _{max} = 80 mm Page A-119
 G1011 s = 2–8 mm T _{max} = 32 mm Page A-117	NCCE s = 0,6–2,25 mm T _{max} = 3 mm Shank tool: <i>Page A 220*</i> <i>Page A 256*</i>	G1042 s = 3–6 mm T _{max} = 60 mm <i>Page A 213*</i>	NCDE s = 2,2–8,0 mm T _{max} = 45 mm Shank tool: <i>Page A 226*</i> <i>Page A 260*</i>
	NCNE s = 0,6–2,25 mm T _{max} = 3 mm Shank tool: <i>Page A 224*</i> <i>Page A 258*</i>	XLCFN s = 3–8 mm T _{max} = 80 mm <i>Page A 216*</i>	NCME s = 2,2–4,0 mm T _{max} = 45 mm Shank tool: <i>Page A 228*</i> <i>Page A 262*</i>

* The pages indicated in italics refer to the Walter General catalogue 2012.

Grooving/recessing		Axial grooving		Internal grooving
<p>GX system</p>		<p>GX system</p>		<p>GX system</p>
<p>NEW G1011</p> <p>s = 2–8 mm T_{max} = 32 mm</p> <p>Page A-117</p>	<p>G1511</p> <p>s = 2–6 mm T_{max} = 6 mm</p> <p>Page A 208*</p>	<p>G1111</p> <p>s = 3–6 mm T_{max} = 25 mm</p> <p>Page A 230*</p>	<p>I 12</p> <p>s = 1,95–2,5 mm T_{max} = 3 mm</p> <p>Page A 245*</p>	
<p>G1521</p> <p>s = 2–6 mm T_{max} = 6 mm</p> <p>Page A 208*</p>	<p>G1551</p> <p>s = 3–6 mm T_{max} = 6 mm</p> <p>Page A 209*</p>	<p>NCEE</p> <p>s = 3–6 mm T_{max} = 15 mm</p> <p>Shank tool: Page A 232* Page A 264*</p>	<p>NCHE</p> <p>s = 3–6 mm T_{max} = 15 mm</p> <p>Shank tool: Page A 234* Page A 266*</p>	<p>NCAI</p> <p>s = 1,95–6 mm T_{max} = 19 mm</p> <p>Page A 246*</p>
<p>NCAE / NCBE</p> <p>s = 2–8 mm T_{max} = 21 mm</p> <p>Shank tool: Page A 218* Page A 250*</p>	<p>NCCE</p> <p>s = 0,6–2,25 mm T_{max} = 3 mm</p> <p>Shank tool: Page A 222* Page A 256*</p>	<p>NCFE</p> <p>s = 3–6 mm T_{max} = 21 mm</p> <p>Shank tool: Page A 236* Page A 286*</p>	<p>NCOE</p> <p>s = 3–6 mm T_{max} = 21 mm</p> <p>Shank tool: Page A 238* Page A 270*</p>	<p>NCCI</p> <p>s = 0,6–3,25 mm T_{max} = 3 mm</p> <p>Page A 248*</p>
<p>NCLE</p> <p>s = 2–8 mm T_{max} = 21 mm</p> <p>Shank tool: Page A 220* Page A 254*</p>	<p>NCNE</p> <p>s = 0,6–2,25 mm T_{max} = 3 mm</p> <p>Shank tool: Page A 224* Page A 258*</p>	<p>NCFE-C</p> <p>s = 3–6 mm T_{max} = 21 mm</p> <p>Shank tool: Page A 240* Page A 272*</p>	<p>NCOE-C</p> <p>s = 3–6 mm T_{max} = 21 mm</p> <p>Shank tool: Page A 242* Page A 274*</p>	



Walter Cut G1011

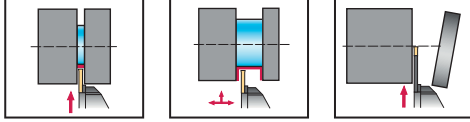

- External machining
- Radial grooving 0°
- One-piece shank tool
- For grooving, recessing and parting off
- For GX cutting inserts

Tool	Designation	s mm	T _{max} mm	D _{max} mm	h=h ₁ mm	b mm	f ₁ mm	l ₁ mm	l ₄ mm	s ₁ mm	Type
	G1011.1212R/L-2T8GX16	2	8		12	12	11	122	32	1,6	GX 16-1E2/F2...
	G1011.1212R/L-2T12GX16		12		12	12	11	122	32	1,6	
	G1011.1616R/L-2T8GX16		8		16	16	15	132	36	1,6	
	G1011.1616R/L-2T15GX16		16		16	16	15	136	36	1,6	
	G1011.2020R/L-2T8GX16		8		20	20	19	142	32	1,6	
	G1011.2020R/L-2T15GX16		16		20	20	19	146	36	1,6	
	G1011.2525R/L-2T8GX16		8		25	25	24	142	32	1,6	
	G1011.2525R/L-2T15GX16		16		25	25	24	146	36	1,6	
	G1011.1616R/L-3T12GX24		12		16	16	15	135	35	2,4	
	G1011.1616R/L-3T21GX24		21	80	16	16	15	150	40	2,4	
	G1011.2020R/L-3T12GX24		12		20	20	19	145	35	2,4	
	G1011.2012R/L-3T21GX24		21	80	20	12	11	150	40	2,4	
G1011.2020R/L-3T21GX24	21	80	20	20	19	150	40	2,4			
G1011.2525R/L-3T12GX24	12		25	25	24	145	35	2,4			
G1011.2525R/L-3T21GX24	21	80	25	25	24	150	40	2,4			
	G1011.1616R/L-4T12GX24	4	12		16	16	14	135	35	3,4	GX 24-3E4/F4...
	G1011.1616R/L-4T21GX24		21	80	16	16	14	150	40	3,4	
	G1011.2020R/L-4T12GX24		12		20	20	18	145	35	3,4	
	G1011.2012R/L-4T21GX24		21	80	20	12	10	150	40	3,4	
	G1011.2020R/L-4T21GX24		21	80	20	20	18	150	40	3,4	
	G1011.2525R/L-4T12GX24		12		25	25	23	145	35	3,4	
	G1011.2525R/L-4T21GX24		21	80	25	25	23	150	40	3,4	
	G1011.2020R/L-5T12GX24		12		20	20	18	145	35	4,2	
	G1011.2020R/L-5T21GX24		21	80	20	20	18	150	40	4,2	
	G1011.2525R/L-5T12GX24		12		25	25	23	145	35	4,2	
G1011.2525R/L-5T21GX24	21	80	25	25	23	150	40	4,2			
	G1011.2525R/L-5T32GX24	6	32	120	25	25	23	165	55	4,2	GX 24-4E6/F6...
	G1011.2020R/L-6T12GX24		12		20	20	17	145	35	5,2	
	G1011.2020R/L-6T21GX24		21	80	20	20	17	150	40	5,2	
	G1011.2525R/L-6T12GX24		12		25	25	22	145	35	5,2	
	G1011.2525R/L-6T21GX24		21	80	25	25	22	150	40	5,2	
	G1011.2525R/L-6T32GX24		32	120	25	25	22	165	55	5,2	
	★ G1011.2525R/L-8T28GX30	8	28	120	25	25	22	165	55	6,1	GX 30-5E8..
	★ G1011.3232R/L-8T28GX30		28	120	32	32	29	165	55	6,1	

For T_{max} with greater diameters than D_{max}, see technical information on page A 318 of the Walter General catalogue 2012.

$$f = f_1 + s/2$$

Ordering example: Right-handed shank tool: G1011.2020R-3T12GX24 / left-handed shank tool: G1011.2020L-3T12GX24

Bodies and assembly parts are included in the scope of delivery.

Assembly parts

	Type	GX 16-1E2/F2...-GX 30-5E8..
	Clamping screw for grooving insert Tightening torque	FS2118 (Torx 20IP) 5,0 Nm
	Torx key	FS1464 (Torx 20IP)



★ New addition to range

Walter Cut G2012

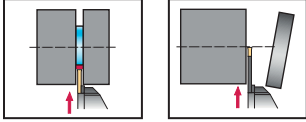

- External machining
- Radial grooving 0°
- One-piece shank tool with internal coolant supply
- For grooving and parting off
- For SX cutting inserts

Tool	Designation	s mm	T _{max} mm	h=h ₁ mm	b mm	f ₁ mm	l ₁ mm	l ₄ mm	Type
	★ G2012.2020R/L-3T22SX-P	3	22	20	20	19	125	38	SX-3 ..
	★ G2012.2525R/L-3T33SX-P		33	25	25	24	150	43	
	★ G2012.2020R/L-4T29SX-P	4	29	20	20	18	125	45	SX-4 ..
	★ G2012.2525R/L-4T33SX-P		33	25	25	23	150	48	

For instructions on replacing the cutting edge, see page A-150.
 Connection set for internal coolant supply with G 1/8" thread, see page A-151.
 $f = f_1 + s/2$

Ordering example: Right-handed shank tool: G2012.2020R-3T22SX-P / left-handed shank tool: G2012.2020L-3T22SX-P
 Bodies and assembly parts are included in the scope of delivery.

Assembly parts	Type	SX-3 .. – SX-4 ..
	1/8" blind plugs	FS2258

Accessories	Type	SX-3 .. – SX-4 ..
	Mounting wrench for grooving insert	FS1494

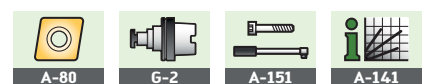

★ New addition to range

Walter Cut G2042

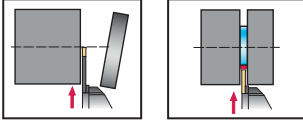

- External machining
- Radial grooving 0°
- Deep parting blade
- For parting off and grooving
- For SX cutting inserts

Tool	Designation	s mm	T _{max} mm	h ₄ mm	l ₁ mm	h ₁ mm	Type
	★ G2042.26N-2T30SX	2	30	26	150	21,1	SX-2..
	★ G2042.32N-2T30SX		30	32	150	24,8	
	★ G2042.26N-3T38SX	3	38	26	150	21	SX-3..
	★ G2042.32N-3T50SX		50	32	150	24,7	
	★ G2042.26N-4T40SX	4	40	26	150	20,9	SX-4..
	★ G2042.32N-4T50SX		50	32	150	24,6	
	★ G2042.32N-5T60SX	5	60	32	150	24,5	SX-5..
	★ G2042.45N-5T80SX		80	45	150	37	
	★ G2042.32N-6T60SX	6	60	32	150	24,4	SX-6..
	★ G2042.45N-6T80SX		80	45	150	36,9	
	★ G2042.26R/L-2T26SX	2	26	26	110	21	SX-2..
	★ G2042.32R/L-2T26SX		26	32	110	24,6	
	★ G2042.26R/L-3T33SX	3	33	26	110	21	SX-3..
	★ G2042.32R/L-3T33SX		33	32	110	24,6	
	★ G2042.32R/L-4T33SX	4	33	32	110	24,6	SX-4..

For clamping blocks, see page A 217 of the Walter General catalogue 2012.

For instructions on replacing the cutting edge, see page A-150.

Accessories

	Type	SX-2.. –SX-6..
	Mounting wrench for grooving insert	FS1494

★ New addition to range



Cutting data for turning inserts – Negative basic shape

Carbide grades

Material group	Structure of main material groups and identification letters		Brinell hardness HB	Tensile strength R_m N/mm ²	Machining group ¹		Cutting material grades							
							Starting values for cutting speed v_c [m/min]							
							HC			WPP20S				
							WPP10S			WPP20S				
						f [mm/U]		f [mm/U]		f [mm/U]				
						0,10	0,40	0,60	0,10	0,40	0,60			
P	Unalloyed steel	C ≤ 0.25%	annealed	125	428	P1	●●	●	620	470	360	520	380	310
		C > 0.25... ≤ 0.55%	annealed	190	639	P2	●●	●	530	380	300	440	310	240
		C > 0.25... ≤ 0.55%	tempered	210	708	P3	●●	●	400	320	260	330	260	210
		C > 0.55%	annealed	190	639	P4	●●	●	500	360	280	420	290	220
		C > 0.55%	tempered	300	1013	P5	●●	●	320	240	220	260	190	170
	Low-alloyed steel	Free cutting steel (short-chipping)	annealed	220	745	P6	●●	●	500	360	280	420	290	220
		annealed	175	591	P7	●●	●	460	340	290	380	280	230	
		tempered	300	1013	P8	●●	●	290	230	200	240	170	150	
		tempered	380	1282	P9	●●	●	250	180	140	210	150	110	
		tempered	430	1477	P10	●●	●	60	50					
High-alloyed steel and high-alloyed tool steel	annealed	200	675	P11	●●	●	480	340	220	400	280	170		
	hardened and tempered	300	1013	P12	●●	●	240	140	120	190	120	90		
	hardened and tempered	400	1361	P13	●●	●	70	60						
Stainless steel	ferritic/martensitic, annealed	200	675	P14	●●	●	380	300	260	310	250	200		
	martensitic, tempered	330	1114	P15	●●	●	280	200	160	220	150	110		
M	Stainless steel	austenitic, quench hardened	200	675	M1	●●	●							
		austenitic, precipitation hardened (PH)	300	1013	M2	●●	●							
		austenitic/ferritic, duplex	230	778	M3	●●	●							
K	Malleable cast iron	ferritic	200	675	K1	●●	●	320	210	160	280	220	160	
		pearlitic	260	867	K2	●●	●	270	170	120	240	180	110	
	Grey cast iron	low tensile strength	180	602	K3	●●	●	580	340	240	510	260	190	
		high tensile strength/austenitic	245	825	K4	●●	●	320	220	150	240	180	110	
	Cast iron with spheroidal graphite	ferritic	155	518	K5	●●	●	340	240	180	260	190	140	
		pearlitic	265	885	K6	●●	●	240	180	150	190	140	110	
GGV (CGI)		200	675	K7	●●	●	290	190	160					
N	Aluminium wrought alloys	cannot be hardened	30	–	N1									
		hardenable, hardened	100	343	N2									
	Cast aluminium alloys	≤ 12% Si, cannot be hardened	75	260	N3									
		≤ 12% Si, hardenable, hardened	90	314	N4									
		> 12% Si, cannot be hardened	130	447	N5									
	Magnesium alloys		70	250	N6									
	Copper and copper alloys (bronze/brass)	unalloyed, electrolytic copper	100	343	N7									
		brass, bronze, red brass	90	314	N8									
		Cu-alloys, short-chipping	110	382	N9									
		high-strength, Ampco	300	1013	N10									
S	Heat-resistant alloys	Fe-based	annealed	200	675	S1	●●	●						
			hardened	280	943	S2	●●	●						
		Ni or Co base	annealed	250	839	S3	●●	●						
			hardened	350	1177	S4	●●	●						
			cast	320	1076	S5	●●	●						
	Titanium alloys	pure titanium	200	675	S6	●●	●							
		α and β alloys, hardened	375	1262	S7	●●	●							
		β alloys	410	1396	S8	●●	●							
	Tungsten alloys		300	1013	S9									
	Molybdenum alloys		300	1013	S10									
H	Hardened steel	hardened and tempered	50 HRC	–	H1	●	●●							
		hardened and tempered	55 HRC	–	H2	●	●●							
		hardened and tempered	60 HRC	–	H3	●	●●							
Hardened cast iron	hardened and tempered	55 HRC	–	H4	●	●●								
O	Thermoplasts	without abrasive fillers			O1									
	Thermosetting plastics	without abrasive fillers			O2									
	Plastic, glass-fibre reinforced	GFRP			O3									
	Plastic, carbon-fibre reinforced	CFRP			O4									
	Plastic, aramid-fibre reinforced	AFRP			O5									
	Graphite (technical)		80 Shore			O6								

- Recommended application (the specified cutting data are regarded as starting values for the recommended application)
- Possible application

Note:

If dry machining is possible, the tool life reduces by an average of 20–30%.

¹ The classification of the machining groups can be found in the Walter General catalogue 2012 from page H 8 onwards.

Cutting data for turning inserts – Negative basic shape

Carbide grades

Material group	Structure of main material groups and identification letters		Brinell hardness HB	Tensile strength R _m N/mm ²	Machining group ¹	= Cutting data for wet machining = Dry machining is possible		Cutting material grades			
								Starting values for cutting speed v _c [m/min]			
								HC			
								WSM10			
								f [mm/U]			
								0,10	0,30	0,50	
P	Unalloyed steel	C ≤ 0.25%	annealed	125	428	P1	●●	●	310	290	
		C > 0.25... ≤ 0.55%	annealed	190	639	P2	●●	●	260	240	
		C > 0.25... ≤ 0.55%	tempered	210	708	P3	●●	●	220	200	
		C > 0.55%	annealed	190	639	P4	●●	●	240	220	
		C > 0.55%	tempered	300	1013	P5	●●	●			
		Free cutting steel (short-chipping)	annealed	220	745	P6	●●	●	240	220	
	Low-alloyed steel		annealed	175	591	P7	●●	●			
			tempered	300	1013	P8	●●	●			
			tempered	380	1282	P9	●●	●			
			tempered	430	1477	P10	●●	●			
High-alloyed steel and high-alloyed tool steel		annealed	200	675	P11	●●	●				
		hardened and tempered	300	1013	P12	●●	●				
		hardened and tempered	400	1361	P13	●●	●				
Stainless steel		ferritic/martensitic, annealed	200	675	P14	●●	●	270	240	200	
		martensitic, tempered	330	1114	P15	●●	●	230	170	150	
M	Stainless steel		austenitic, quench hardened	200	675	M1	●●	●	260	210	130
			austenitic, precipitation hardened (PH)	300	1013	M2	●●	●	160	140	
			austenitic/ferritic, duplex	230	778	M3	●●	●	170	150	110
K	Malleable cast iron		ferritic	200	675	K1	●●	●			
			pearlitic	260	867	K2	●●	●			
	Grey cast iron		low tensile strength	180	602	K3	●●	●			
			high tensile strength/austenitic	245	825	K4	●●	●			
	Cast iron with spheroidal graphite		ferritic	155	518	K5	●●	●			
		pearlitic	265	885	K6	●●	●				
	GGV (CGI)		200	675	K7	●●	●				
N	Aluminium wrought alloys		cannot be hardened	30	–	N1					
			hardenable, hardened	100	343	N2					
	Cast aluminium alloys		≤ 12% Si, cannot be hardened	75	260	N3					
			≤ 12% Si, hardenable, hardened	90	314	N4					
			> 12% Si, cannot be hardened	130	447	N5					
		Magnesium alloys		70	250	N6					
	Copper and copper alloys (bronze/brass)		unalloyed, electrolytic copper	100	343	N7					
			brass, bronze, red brass	90	314	N8					
			Cu-alloys, short-chipping	110	382	N9					
			high-strength, Ampco	300	1013	N10					
S	Heat-resistant alloys	Fe-based	annealed	200	675	S1	●●	●	100	65	
			hardened	280	943	S2	●●	●	80	55	
		Ni or Co base	annealed	250	839	S3	●●	●	80	55	
			hardened	350	1177	S4	●●	●	70	45	
		cast	320	1076	S5	●●	●	60	35		
	Titanium alloys		pure titanium	200	675	S6	●●	●			
			α and β alloys, hardened	375	1262	S7	●●	●			
			β alloys	410	1396	S8	●●	●			
	Tungsten alloys		300	1013	S9						
	Molybdenum alloys		300	1013	S10						
H	Hardened steel		hardened and tempered	50 HRC	–	H1	●	●●			
			hardened and tempered	55 HRC	–	H2	●	●●			
			hardened and tempered	60 HRC	–	H3	●	●●			
		Hardened cast iron		hardened and tempered	55 HRC	–	H4	●	●●		
O		Thermoplasts		without abrasive fillers							
		Thermosetting plastics		without abrasive fillers							
		Plastic, glass-fibre reinforced		GFRP							
		Plastic, carbon-fibre reinforced		CFRP							
		Plastic, aramid-fibre reinforced		AFRP							
		Graphite (technical)		80 Shore							

- Recommended application (the specified cutting data are regarded as starting values for the recommended application)
- Possible application

Note:
If dry machining is possible, the tool life reduces by an average of 20–30%.

¹ The classification of the machining groups can be found in the Walter General catalogue 2012 from page H 8 onwards.



The specified cutting data are average recommended values. For special applications, adjustment is recommended.

Cutting material grades

Starting values for cutting speed v_c [m/min]

WSM20			WSM30			WKK10S			WKK20S			WAK10			WAK20			WAK30			WS10			
f [mm/U]			f [mm/U]			f [mm/U]			f [mm/U]			f [mm/U]			f [mm/U]			f [mm/U]			f [mm/U]			
0,10	0,30	0,50	0,10	0,30	0,50	0,10	0,40	0,60	0,10	0,40	0,60	0,10	0,40	0,60	0,10	0,40	0,60	0,10	0,40	0,60	0,10	0,30	0,50	
270	250		250	230					620	470	360				620	470	360	340	230	190				
220	200		200	180					530	380	310				530	380	310	290	190	150				
180	160		160	140					400	310	260				400	310	260	210	170	130				
200	180		180	160					510	360	290				510	360	290	270	170	130				
200	180		180	160					320	240	220				320	240	220	160	110	90				
									240	170	150				460	340	290	240	170	150				
									160	100	70				360	260	240	160	100	70				
									120	80	50				260	180	140	120	80	50				
															70	60								
									240	170	100				480	340	220	240	170	100				
									100	70	60				250	150	110	100	70	60				
															80	70								
250	220	180	230	200	160																			
190	150	130	150	130	110																			
240	170	110	200	140	90																			
140	120		110	90																				
150	130	90	130	110	70																			
							370	260	180	300	200	150	370	260	180	300	200	150	240	160	130			
							330	220	140	260	160	110	330	220	140	260	160	110	200	120	90			
							620	410	300	550	320	230	620	410	300	550	320	230	490	250	180			
							390	260	180	300	210	140	390	260	180	300	210	140	230	170	110			
							410	300	230	320	230	170	410	300	230	320	230	170	250	180	130			
							300	230	180	230	170	140	300	230	180	230	170	140	180	130	110			
							320	200					320	200										
90	60		80	50																		90		
70	50		60	40																		70		
70	50		60	30																		70		
60	40		50	30																		60		
50	30		40	20																		50		
																						200	180	140
70	45	40																				90	55	45
40	30	25																				55	35	30
							55						55											
							45						45											
							35						35											
							45						45											

HC = Coated carbide
HW = Uncoated carbide

Cutting data for turning inserts – Positive basic shape

Carbide grades

Material group	Structure of main material groups and identification letters		Brinell hardness HB	Tensile strength R_m N/mm ²	Machining group ¹		Cutting material grades							
							Starting values for cutting speed v_c [m/min]							
							WPP10S			WPP20S				
							f [mm/U]			f [mm/U]				
			0,10	0,20	0,40	0,10	0,20	0,40						
P	Unalloyed steel	C ≤ 0.25%	annealed	125	428	P1	●●	●	560	500	430	470	430	350
		C > 0.25... ≤ 0.55%	annealed	190	639	P2	●●	●	470	430	340	400	360	280
		C > 0.25... ≤ 0.55%	tempered	210	708	P3	●●	●	360	330	300	290	260	240
		C > 0.55%	annealed	190	639	P4	●●	●	460	430	410	380	350	330
		C > 0.55%	tempered	300	1013	P5	●●	●	270	240	220	220	190	170
	Low-alloyed steel	Free cutting steel (short-chipping)	annealed	220	745	P6	●●	●	460	430	410	380	350	330
		annealed		175	591	P7	●●	●	420	390	370	360	330	300
		tempered		300	1013	P8	●●	●	250	220	200	200	170	150
		tempered		380	1282	P9	●●	●	190	160	140	150	120	90
		tempered		430	1477	P10	●●	●	60	50		50	40	
High-alloyed steel and high-alloyed tool steel	annealed		200	675	P11	●●	●	440	410	390	360	330	300	
	hardened and tempered		300	1013	P12	●●	●	210	190	170	170	140	120	
	hardened and tempered		400	1361	P13	●●	●	70	60		60	50		
Stainless steel	ferritic/martensitic, annealed		200	675	P14	●●	●	380	350	330	270	240	220	
	martensitic, tempered		330	1114	P15	●●	●	190	160	140	160	130	110	
M	Stainless steel	austenitic, quench hardened		200	675	M1	●●	●						
		austenitic, precipitation hardened (PH)		300	1013	M2	●●	●						
		austenitic/ferritic, duplex		230	778	M3	●●	●						
K	Malleable cast iron	ferritic		200	675	K1	●●	●	280	250	230	250	220	200
		pearlitic		260	867	K2	●●	●	240	210	190	210	180	160
	Grey cast iron	low tensile strength		180	602	K3	●●	●	530	490	450	480	450	430
		high tensile strength/austenitic		245	825	K4	●●	●	280	250	230	210	180	160
	Cast iron with spheroidal graphite	ferritic		155	518	K5	●●	●	300	270	250	230	200	180
pearlitic			265	885	K6	●●	●	210	180	160	160	130	110	
GGV (CGI)		200	675	K7	●●	●	280	230	210					
N	Aluminium wrought alloys	cannot be hardened		30	–	N1	●●	●						
		hardenable, hardened		100	343	N2	●●	●						
	Cast aluminium alloys	≤ 12% Si, cannot be hardened		75	260	N3	●●	●						
		≤ 12% Si, hardenable, hardened		90	314	N4	●●	●						
	Magnesium alloys	> 12% Si, cannot be hardened		130	447	N5	●●	●						
Copper and copper alloys (bronze/brass)	unalloyed, electrolytic copper		100	343	N7	●●	●							
	brass, bronze, red brass		90	314	N8	●●	●							
	Cu-alloys, short-chipping		110	382	N9	●●	●							
	high-strength, Ampco		300	1013	N10	●●	●							
S	Heat-resistant alloys	Fe-based	annealed	200	675	S1	●●	●						
			hardened	280	943	S2	●●	●						
		Ni or Co base	annealed	250	839	S3	●●	●						
			hardened	350	1177	S4	●●	●						
	Titanium alloys	cast	320	1076	S5	●●	●							
		pure titanium	200	675	S6	●●	●							
	Tungsten alloys	α and β alloys, hardened	375	1262	S7	●●	●							
β alloys		410	1396	S8	●●	●								
Molybdenum alloys		300	1013	S9	●●	●								
H	Hardened steel		50 HRC	–	H1	●	●●							
			55 HRC	–	H2	●	●●							
			60 HRC	–	H3	●	●●							
	Hardened cast iron	hardened and tempered	55 HRC	–	H4	●	●●							
O	Thermoplasts	without abrasive fillers												
	Thermosetting plastics	without abrasive fillers												
	Plastic, glass-fibre reinforced	GFRP												
	Plastic, carbon-fibre reinforced	CFRP												
	Plastic, aramid-fibre reinforced	AFRP												
	Graphite (technical)		80 Shore											

- Recommended application (the specified cutting data are regarded as starting values for the recommended application)
- Possible application

Note:

If dry machining is possible, the tool life reduces by an average of 20–30%.

¹ The classification of the machining groups can be found in the Walter General catalogue 2012 from page H 8 onwards.

Cutting data for turning inserts – Positive basic shape

Carbide grades

Material group	Structure of main material groups and identification letters		Brinell hardness HB	Tensile strength R_m N/mm ²	Machining group ¹		Cutting material grades				
							Starting values for cutting speed v_c [m/min]				
							HC				
							WKK20S				
							f [mm/U]				
							0,10	0,20	0,40		
P	Unalloyed steel	C ≤ 0.25%	annealed	125	428	P1	●●	●	560	500	420
		C > 0.25... ≤ 0.55%	annealed	190	639	P2	●●	●	480	430	340
		C > 0.25... ≤ 0.55%	tempered	210	708	P3	●●	●	340	300	260
		C > 0.55%	annealed	190	639	P4	●●	●	440	400	310
		C > 0.55%	tempered	300	1013	P5	●●	●	290	260	220
	Low-alloyed steel	Free cutting steel (short-chipping)	annealed	220	745	P6	●●	●	360	330	280
		annealed		175	591	P7	●●	●	410	370	310
		tempered		300	1013	P8	●●	●	290	260	220
		tempered		380	1282	P9	●●	●	220	200	140
		tempered		430	1477	P10	●●	●	60	50	
High-alloyed steel and high-alloyed tool steel	annealed		200	675	P11	●●	●	430	380	300	
	hardened and tempered		300	1013	P12	●●	●	220	200	130	
	hardened and tempered		400	1361	P13	●●	●	70	60		
Stainless steel	ferritic/martensitic, annealed		200	675	P14	●●	●	340	300	280	
	martensitic, tempered		330	1114	P15	●●	●	250	220	180	
M	Stainless steel	austenitic, quench hardened		200	675	M1	●●	●			
		austenitic, precipitation hardened (PH)		300	1013	M2	●●	●			
		austenitic/ferritic, duplex		230	778	M3	●●	●			
K	Malleable cast iron	ferritic		200	675	K1	●●	●	240	220	170
		pearlitic		260	867	K2	●●	●	220	200	150
	Grey cast iron	low tensile strength		180	602	K3	●●	●	500	450	290
		high tensile strength/austenitic		245	825	K4	●●	●	270	240	190
	Cast iron with spheroidal graphite	ferritic		155	518	K5	●●	●	290	260	210
		pearlitic		265	885	K6	●●	●	210	190	160
GGV (CGI)		200	675	K7	●●	●					
N	Aluminium wrought alloys	cannot be hardened		30	–	N1	●●	●			
		hardenable, hardened		100	343	N2	●●	●			
	Cast aluminium alloys	≤ 12% Si, cannot be hardened		75	260	N3	●●	●			
		≤ 12% Si, hardenable, hardened		90	314	N4	●●	●			
		> 12% Si, cannot be hardened		130	447	N5					
	Magnesium alloys		70	250	N6						
	Copper and copper alloys (bronze/brass)	unalloyed, electrolytic copper		100	343	N7	●●	●			
brass, bronze, red brass			90	314	N8	●●	●				
Cu-alloys, short-chipping			110	382	N9	●●	●				
high-strength, Ampco			300	1013	N10						
S	Heat-resistant alloys	Fe-based	annealed		200	675	S1	●●	●		
			hardened		280	943	S2	●●	●		
		Ni or Co base	annealed		250	839	S3	●●	●		
			hardened		350	1177	S4	●●	●		
	Titanium alloys	cast		320	1076	S5	●●	●			
		pure titanium		200	675	S6	●●	●			
		α and β alloys, hardened		375	1262	S7	●●	●			
	Tungsten alloys	β alloys		410	1396	S8	●●	●			
			300	1013	S9						
Molybdenum alloys		300	1013	S10							
H	Hardened steel	hardened and tempered		50 HRC	–	H1	●	●●			
		hardened and tempered		55 HRC	–	H2	●	●●			
		hardened and tempered		60 HRC	–	H3	●	●●			
	Hardened cast iron	hardened and tempered		55 HRC	–	H4	●	●●			
O	Thermoplasts	without abrasive fillers				O1					
	Thermosetting plastics	without abrasive fillers				O2					
	Plastic, glass-fibre reinforced	GFRP				O3					
	Plastic, carbon-fibre reinforced	CFRP				O4					
	Plastic, aramid-fibre reinforced	AFRP				O5					
	Graphite (technical)		80 Shore				O6				

- Recommended application (the specified cutting data are regarded as starting values for the recommended application)
- Possible application

Note:

If dry machining is possible, the tool life reduces by an average of 20–30%.

¹ The classification of the machining groups can be found in the Walter General catalogue 2012 from page H 8 onwards.

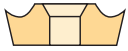

The specified cutting data are average recommended values.
For special applications, adjustment is recommended.

Cutting material grades																		
Starting values for cutting speed v_c [m/min]																		
WAK10			WAK20			WAK30			WXN10			HW			WS10			
f [mm/U]			f [mm/U]			f [mm/U]			f [mm/U]			f [mm/U]			f [mm/U]			
0,10	0,20	0,40	0,10	0,20	0,40	0,10	0,20	0,40	0,10	0,20	0,40	0,10	0,20	0,40	0,10	0,20	0,40	
			560	500	420	430	390	290										
			480	430	340	360	320	240										
			340	300	260	240	220	190										
			440	400	310	330	290	240										
			290	260	220	200	180	140										
			360	330	280	260	240	210										
			410	370	310	300	270	210										
			290	260	220	190	170	140										
			220	200	140	120	100	60										
			60	50														
			430	380	300	300	270	210										
			220	200	130	110	100	80										
			70	60														
			340	300	280	230	210	190										
			250	220	180	160	140	110										
									220	200								
									100	80								
									170	130								
	310	280	210	240	220	170	190	170	120									
	290	260	190	220	200	150	170	150	100									
	560	500	370	500	450	290	450	470	230									
	350	320	240	270	240	190	210	180	150									
	370	330	270	290	260	210	230	200	160									
	270	240	210	210	190	160	160	150	120									
	310	260	210															
										3000	2400	1800	2400	1800	1300			
										900	720	360	750	600	300			
										960	540	360	800	450	300			
										600	360	240	500	300	200			
										720	480	320	600	400	270			
										480	360	300	400	300	250			
										340	240	160	280	200	130			
										110	90					90		
										80	70					70		
										60	50					70		
										60	25					60		
										50	25					50		
										220	200	160				200	180	140
										100	70	60				90	60	45
																55	35	30
	50																	
	40																	
	30																	
	40																	

Cutting data for turning inserts – Positive and negative basic shape CBN and ceramic

Material group	Structure of main material groups and identification letters		Brinell hardness HB	Tensile strength R _m N/mm ²	Machining group ¹			
	= Cutting data for wet machining = Dry machining is possible							
P	Unalloyed steel	C ≤ 0.25%	annealed	125	428	P1		
		C > 0.25... ≤ 0.55%	annealed	190	639	P2		
		C > 0.25... ≤ 0.55%	tempered	210	708	P3		
		C > 0.55%	annealed	190	639	P4		
		C > 0.55%	tempered	300	1013	P5		
		Free cutting steel (short-chipping)	annealed	220	745	P6		
	Low-alloyed steel		annealed	175	591	P7		
			tempered	300	1013	P8		
			tempered	380	1282	P9		
			tempered	430	1477	P10		
	High-alloyed steel and high-alloyed tool steel		annealed	200	675	P11		
			hardened and tempered	300	1013	P12		
			hardened and tempered	400	1361	P13		
	Stainless steel		ferritic/martensitic, annealed	200	675	P14		
			martensitic, tempered	330	1114	P15		
M	Stainless steel		austenitic, quench hardened	200	675	M1		
			austenitic, precipitation hardened (PH)	300	1013	M2		
			austenitic/ferritic, duplex	230	778	M3		
K	Malleable cast iron		ferritic	200	675	K1	●●	
			pearlitic	260	867	K2	●●	
	Grey cast iron		low tensile strength	180	602	K3	●●	
			high tensile strength/austenitic	245	825	K4	●●	
	Cast iron with spheroidal graphite		ferritic	155	518	K5	●●	
			pearlitic	265	885	K6	●●	
	GGV (CGI)		200	675	K7			
N	Aluminium wrought alloys		cannot be hardened	30	–	N1		
			hardenable, hardened	100	343	N2		
	Cast aluminium alloys		≤ 12% Si, cannot be hardened	75	260	N3		
			≤ 12% Si, hardenable, hardened	90	314	N4		
			> 12% Si, cannot be hardened	130	447	N5		
	Magnesium alloys			70	250	N6		
		Copper and copper alloys (bronze/brass)		unalloyed, electrolytic copper	100	343	N7	
			brass, bronze, red brass	90	314	N8		
			Cu-alloys, short-chipping	110	382	N9		
			high-strength, Ampco	300	1013	N10		
S	Heat-resistant alloys	Fe-based	annealed	200	675	S1		
			hardened	280	943	S2		
		Ni or Co base	annealed	250	839	S3	●●	
			hardened	350	1177	S4	●●	
			cast	320	1076	S5	●●	
	Titanium alloys		pure titanium	200	675	S6		
			α and β alloys, hardened	375	1262	S7		
			β alloys	410	1396	S8		
	Tungsten alloys			300	1013	S9		
	Molybdenum alloys			300	1013	S10		
H	Hardened steel		hardened and tempered	50 HRC	–	H1	●	●●
			hardened and tempered	55 HRC	–	H2	●	●●
			hardened and tempered	60 HRC	–	H3	●	●●
	Hardened cast iron		hardened and tempered	55 HRC	–	H4	●	●●
O	Thermoplasts		without abrasive fillers			O1		
	Thermosetting plastics		without abrasive fillers			O2		
	Plastic, glass-fibre reinforced		GFRP			O3		
	Plastic, carbon-fibre reinforced		CFRP			O4		
	Plastic, aramid-fibre reinforced		AFRP			O5		
	Graphite (technical)			80 Shore		O6		

- Recommended application (the specified cutting data are regarded as starting values for the recommended application)
- Possible application

¹The classification of the machining groups can be found in the Walter General catalogue 2012 from page H 8 onwards.

Cutting tool material application tables – Turning

Carbide																
Walter grade designation	Standard designation	Workpiece material group						Application range						Coating procedure	Coating composition	Indexable insert example
		P	M	K	N	S	H	O	01	10	20	30	40			
		Steel	Stainless steel	Cast iron	NF metals	Difficult-to-cut materials	Hard materials	Other	05	15	25	35	45			
WPP 10S	HC - P 10	●●							▲					CVD	TiCN + Al ₂ O ₃ (+TiCN)	
	HC - K 20			●						▲						
WPP 20S	HC - P 20	●●							▲					CVD	TiCN + Al ₂ O ₃ (+TiCN)	
	HC - K 30			●						▲						
WPP 30S	HC - P 30	●●							▲					CVD	TiCN + Al ₂ O ₃ (+TiCN)	
WMP 20S	HC - M 15		●●						▲					CVD	TiCN + Al ₂ O ₃ (+TiCN)	
	HC - P 25	●●							▲							
	HC - S 20					●				▲						
WPP 01	HC - P 01	●●							▲					CVD	TiCN + Al ₂ O ₃ (+TiN)	
	HC - K 10			●						▲						
WPP 05	HC - P 05	●●							▲					CVD	TiCN + Al ₂ O ₃ (+TiN)	
WPP 10	HC - P 10	●●							▲					CVD	TiCN + Al ₂ O ₃ (TiN)	
	HC - K 20			●						▲						
WPP 20	HC - P 20	●●							▲					CVD	TiCN + Al ₂ O ₃ (TiN)	
	HC - K 30			●						▲						
WPP 30	HC - P 30	●●							▲					CVD	TiCN + Al ₂ O ₃ (TiN)	
WSM 10	HC - M 10		●●						▲					PVD	TiAlN + Al ₂ O ₃ (ZrCN)	
	HC - S 10					●●			▲							
	HC - P 10	●							▲							
WSM 20	HC - M 20		●●						▲					PVD	TiAlN + Al ₂ O ₃ (ZrCN)	
	HC - S 20					●●			▲							
	HC - P 20	●							▲							
WSM 30	HC - M 30		●●						▲					PVD	TiAlN + Al ₂ O ₃ (ZrCN)	
	HC - S 30					●●			▲							
	HC - P 30	●							▲							
WSM 21	HC - M 20		●●						▲					PVD	TiAlN	
	HC - S 20					●●			▲							
	HC - P 20	●●							▲							
WS 10	HW - S 10					●●			▲					—	—	

HC = Coated carbide
HW = Uncoated carbide

●● Primary application
● Other application

Cutting tool material application tables – Turning

Carbide																
Walter grade designation	Standard designation	Workpiece material group						Application range						Coating procedure	Coating composition	Indexable insert example
		P	M	K	N	S	H	O	01	10	20	30	40			
		Steel	Stainless steel	Cast iron	NF metals	Difficult-to-cut materials	Hard materials	Other	05	15	25	35	45			
WKK 10S	HC – K 10			●●					[Application range diagram]				CVD	TiCN + Al ₂ O ₃ (+TiCN)		
	HC – H 30						●		[Application range diagram]							
WKK 20S	HC – K 20			●●					[Application range diagram]				CVD	TiCN + Al ₂ O ₃ (+TiCN)		
	HC – P 10	●							[Application range diagram]							
WAK 10	HC – K 10			●●					[Application range diagram]				CVD	TiCN + Al ₂ O ₃ (+TiN)		
	HC – H 30						●		[Application range diagram]							
WAK 20	HC – K 20			●●					[Application range diagram]				CVD	TiCN + Al ₂ O ₃ (+TiN)		
	HC – P 10	●							[Application range diagram]							
WAK 30	HC – K 30			●●					[Application range diagram]				CVD	TiCN + Al ₂ O ₃ (+TiN)		
	HC – P 40	●							[Application range diagram]							
WXN 10	HC – N 10				●●				[Application range diagram]				PVD	TiCN ^{plus}		
	HC – P 01	●							[Application range diagram]							
	HC – M 01		●						[Application range diagram]							
WK 1	HW – N 10				●●				[Application range diagram]				—	—		
	HW – S 10					●			[Application range diagram]							

CBN and ceramic																
Walter grade designation	Standard designation	Workpiece material group						Application range						Coating procedure	Description	Indexable insert example
		P	M	K	N	S	H	O	01	10	20	30	40			
		Steel	Stainless steel	Cast iron	NF metals	Difficult-to-cut materials	Hard materials	Other	05	15	25	35	45			
WSN 10	CN – K 20			●●					[Application range diagram]				—	Si ₃ N ₄ Ceramic		
WIS 10	CN – S 10					●●			[Application range diagram]				—	Sialon		
WWS 20	CR – S 20					●●			[Application range diagram]				—	Whisker		
	CR – H 20						●		[Application range diagram]							
WCB 30	BL – H 05						●●		[Application range diagram]				—	CBN		
WCB 50	BH – H 10						●●		[Application range diagram]				—	CBN		
	BH – K 10			●					[Application range diagram]							











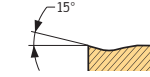
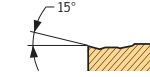

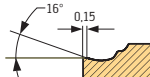
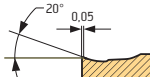

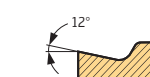
HC = Coated carbide
HW = Uncoated carbide

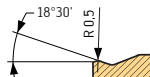
BL = CBN with low CBN content
BH = CBN with high CBN content

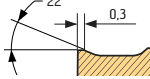
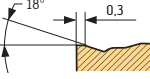
CN = Silicon nitride Si₃N₄
CR = Reinforced ceramic

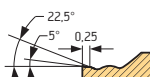
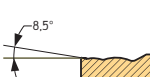
●● Primary application
● Other application

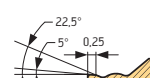
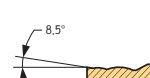
Geometry overview of turning inserts – Negative basic shape

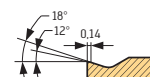
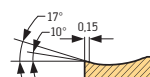
Finishing		Workpiece material group							Cut Main cutting edge	Cut Corner radius	a _p [mm]	f [mm]
Geometry	Remarks/field of applications	P Steel	M Stainless steel	K Cast iron	N NF metals	S Difficult-to-cut materials	H Hard materials	O Other				
 <p>NF – Finishing with wiper technology – High surface quality – High feeds</p> <p>Wiper</p>		••	••	••	•						0,4–3,0	0,10–0,55
 <p>FP5 – Finishing steel materials – Can also be used in semi-finishing as an alternative to MP3 – Curved cutting edge for low cutting forces</p>		••									0,1–2,5	0,04–0,25
 <p>NFT – Finishing titanium materials – Sharp cutting edge with fully ground circumference, first choice – 100° corner with roughing geometry implemented with CNMG basic shape</p>			•		•	••					0,1–2,0	0,05–0,20
 <p>NF4 – Finishing stainless materials – Finishing alloys with difficult cutting properties – Finishing long-chipping steel materials – Curved cutting edge for cutting pressure reduction</p>		•	••			••					0,2–1,6	0,05–0,20
Medium machining												
 <p>NM – Medium machining with wiper technology – High surface quality – High feeds</p> <p>Wiper</p>		••	•	••	•						0,8–4,0	0,15–0,70
 <p>MP3 – Medium machining of long-chipping steel materials – Low cutting forces due to curved cutting edge – Machining forged parts with low material removal</p>		••									0,3–4,0	0,06–0,40
 <p>NMT – Medium machining of titanium materials – Low cutting forces – Machining long-chipping steel materials – Machining forged parts with low material removal</p>		••				••					0,6–4,0	0,12–0,32
 <p>NMS – Medium machining especially for high temperature alloy (Ni, Co, Fe-based alloys) – Sharp, precise cutting edge design – Alternative to NM4 stainless geometry</p>			•			••					0,5–4,0	0,10–0,40

•• Primary application
• Other application

Comment: Sectional views show CNMG 120408 . .

Medium machining – continued

Geometry	Remarks/field of applications	Workpiece material group							Cut Main cutting edge	Cut Corner radius	a _p [mm]	f [mm]
		P Steel	M Stainless steel	K Cast iron	N NF metals	S Difficult-to-cut materials	H Hard materials	O Other				
	MP5 – Universal geometry, steel materials – Reinforced chip breaker blades – Extremely wide range of applications	••									0,5–8,0	0,16–0,55
	NM4 Stainless – Universal geometry, stainless materials – Universal geometry, high temperature alloys – Machining long-chipping steels	•	••			••					0,5–4,5	0,10–0,40
	NM4 Steel – Universal geometry, steel materials	••									0,5–8,0	0,16–0,55
	MK5 – Universal geometry, cast iron materials – Machining high-strength steel materials	•		••							0,6–8,0	0,15–0,90
	NM5 – Universal geometry, cast iron materials	•		••							0,6–7,0	0,15–0,80
	NM9 – Universal roughing of steel materials – Roughing of cast iron materials with WPP05/WPP10	••		•							0,8–10,0	0,15–0,90
	NM6 – Interrupted cuts – Cast skins/forged skins – Stable cutting edge	••		••							0,8–8,0	0,16–0,70





Roughing – Double-sided inserts

	NRT – Roughing of titanium materials – Stable cutting edge with protective chamfer										0,8–9,0	0,18–0,80
	NRS – Roughing especially for high temperature alloy (Ni, Co, Fe-based alloys) – Sharp, precise cutting edge design – Alternative to NR4 geometry		•			••					1,0–6,0	0,15–0,70
	NR4 – Roughing of stainless materials – Roughing of high temperature alloys		••			••					1,2–8,5	0,22–0,80



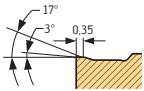
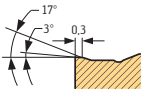

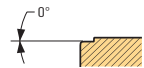
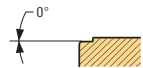
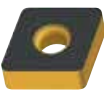
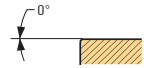
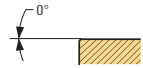
•• Primary application
• Other application

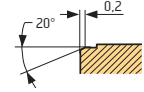
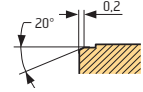
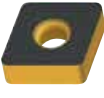
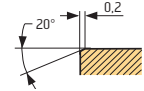
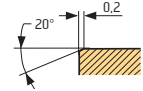
Comment: Sectional views show CNMG 120408 . .

Roughing – Double-sided inserts – continued

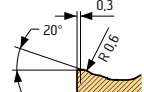
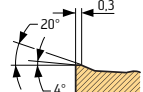
Geometry	Remarks/field of applications	Workpiece material group							Cut Main cutting edge	Cut Corner radius	a _p [mm]	f [mm]
		P Steel	M Stainless steel	K Cast iron	N NF metals	S Difficult-to-cut materials	H Hard materials	O Other				
	RP5 – Roughing steel materials – Stable, positive cutting edge – Open groove for a low cutting temperature	••		•							0,8–12,0	0,2–1,2
	RK5 – Universal geometry, cast iron materials – First choice for grey cast iron			••						0,6–8,0	0,16–0,80	
	. NMA – Universal geometry, cast iron materials			••						0,6–8,0	0,16–0,80	
	RK7 – Cast iron machining with hard crust – Interrupted cuts – Hard machining of steel materials			••			••			0,8–8,0	0,25–0,80	
	T02020 – Cast iron machining with hard crust – Hard machining of steel materials			••			••			0,8–8,0	0,25–0,80	

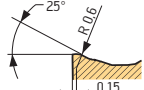
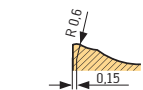

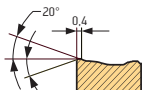
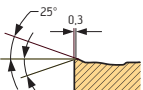







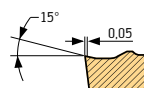
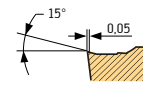

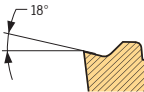
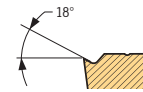

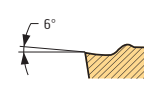
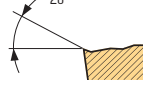
Roughing – Single-sided inserts

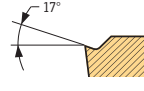
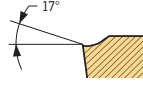
	NRF – Universal single-sided roughing insert – Forged parts with uneven material removal – Low power consumption – Easy-cutting geometry	••	•	•						0,8–12,0	0,25–1,20
	NR6 – Single-sided roughing geometry – Alternative to NRF geometry – Advantages in case of crater wear	••								1,5–12,0	0,35–1,40
	NRR – Heavy roughing – Machining of cast skins/forged parts – Interrupted cuts – Maximum cutting depths and feeds	••		•						2,0–17,0	0,50–1,80

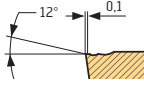
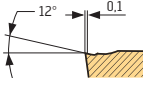
•• Primary application
 • Other application

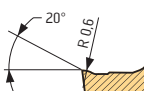
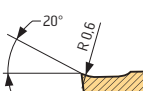
Comment: Sectional views show SNMM 190616 . .

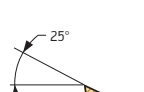
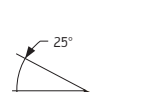

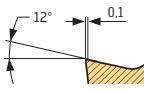
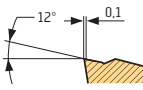



Geometry overview of turning inserts – Positive basic shape

Finishing		Workpiece material group							Cut Main cutting edge	Cut Corner radius	a _p [mm]	f [mm]
		P	M	K	N	S	H	O				
Geometry	Remarks/field of applications	Steel	Stainless steel	Cast iron	NF metals	Difficult-to-cut materials	Hard materials	Other				
 Wiper PF	<ul style="list-style-type: none"> – Finishing with wiper technology – High surface quality – High feeds 	●●	●●	●●		●					0,30–3,0	0,12–0,60
	<ul style="list-style-type: none"> – Finishing insert with fully ground circumference – Long, small diameter shafts with vibration tendency – Low cutting forces 	●●	●●	●	●●	●●					0,12–4,5	0,02–0,45
	<ul style="list-style-type: none"> – Finishing insert – Outstanding chip control – Can also be used for precision boring 	●●	●●			●●					0,1–5,0	0,04–0,40
	<ul style="list-style-type: none"> – Finishing insert with fully ground circumference – Can also be used for precision boring – Extremely narrow chip breaker groove 	●●	●●			●					0,1–4,0	0,04–0,35
	<ul style="list-style-type: none"> – PS5 – Semi-finishing – Universal insert for finishing up to medium machining – Can also be used for counterboring 	●●	●●	●●		●					0,3–2,5	0,08–0,32
Medium machining												
 Wiper PM	<ul style="list-style-type: none"> – Finishing with wiper technology – High surface quality – High feeds 	●●	●	●●		●					0,5–4,0	0,12–0,60
	<ul style="list-style-type: none"> – Universal insert for non-ferrous materials – Sharp cutting edge with fully ground circumference – Polished rake face – Precision finishing on steel and stainless materials 	●	●		●●	●					0,5–6,0	0,02–0,80
	<ul style="list-style-type: none"> – Universal geometry, medium machining to roughing – Extremely large chip breaking area 	●●	●●	●●		●					0,6–5,0	0,12–0,50

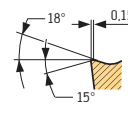
●● Primary application
● Other application

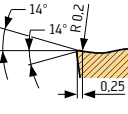
Comment: Sectional views show CCMT 09T308 . . . or CCGT 09T308 . . .

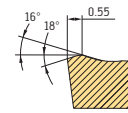
Roughing

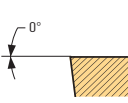
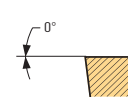
Geometry	Remarks/field of applications	Workpiece material group							Cut Main cutting edge	Cut Corner radius	a_p [mm]	f [mm]
		P	M	K	N	S	H	O				
	M0T – Geometry specifically for Round inserts – Interrupted cuts	••		•							1,0–11,0	0,12–1,3
	PR5 – Geometry specifically for Round inserts – Heavy roughing – Heavy industry, e.g. railways	••		•						1,0–15,0	0,20–1,7	
	HU6 – Heavy roughing – Very good chip breaking – Machining forged parts – Use for machining train wheels	••		••						1,0–15,0	0,12–1,7	
	.CMW – Cast iron machining with hard crust – Interrupted cuts – Stable cutting edge design			••			•			0,2–0,6	0,12–0,50	

- Primary application
- Other application

Comment: Sectional views show CCMT 09T308 . . . , CCGT 09T308 . . .
 CCMW 09T308 . . . and . RCM . 2006 . . .

Usage information: Assembly parts and accessories for the Walter Turn rigid clamping system

Standard clamp

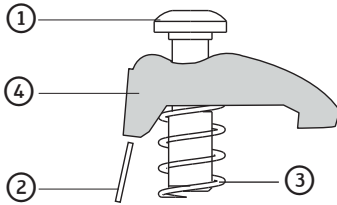

Strengthened clamp with carbide shoe

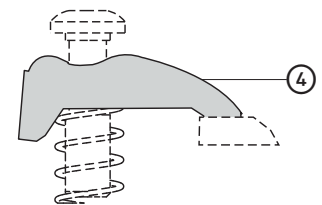
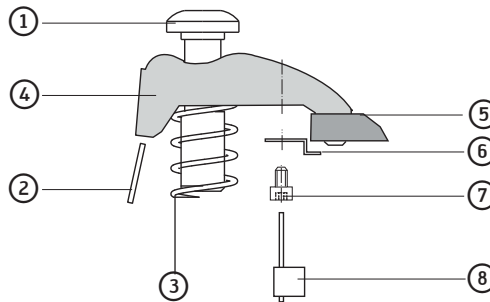

PK254 clamp set
for ceramic inserts
without a hole





Basic shape and size of indexable insert	Standard clamp						Strengthened clamp with carbide shoe		
	CN 09 ..		CN 12 ..	CN 16 ..	CN 19 ..		CN 12 ..	CN 16 ..	CN 12 ..
	DN 11 ..		DN 15 ..	DN 15 ..			DN 15 ..	DN 15 ..	DN 15 ..
	SN 09 ..			SN 15 ..	SN 19 ..	SN 25 ..		SN 15 ..	
	TN 16 ..		TN 22 ..				TN 22 ..		TN 22 ..
		VN 16 ..							
	WN 06 ..		WN 08 ..	WN 10 ..			WN 08 ..	WN 10 ..	WN 08 ..
Set	PK 240 set	PK 244 set	PK 241 set	PK 242 set	PK 243 set	PK 301 set	PK 245 set*	PK 246 set*	PK 254 set**
① Clamp screw	FS 1472 (9 IP)	FS 1473 (15 IP)	FS 1473 (15 IP)	FS 1474 (20 IP)	FS 1474 (20 IP)	FS 1589 (25 IP)	FS 1473 (15 IP)	FS 1474 (20 IP)	FS 1473 (15 IP)
② Pin (fitted in toolholder)	RS 116	RS 117	RS 117	RS 117	RS 117	RS 117	RS 117	RS 117	RS 117
③ Pressure spring	FS 1469	FS 1470	FS 1470	FS 1471	FS 1471	FS 1590	FS 1470	FS 1471	FS 1470
④ Clamp	PK 240	PK 244	PK 241	PK 242	PK 243	PK 301	PK 245	PK 246	PK 254
⑤ Carbide clamping plate							FK 371	FK 372	FK 371
⑥ Clip for clamping plate							FK 373	FK 373	FK 373
⑦ Screw for clamping plate							FS 1492	FS 1492	FS 1492
⑧ Key for clip screw							FS 1490 (7 IP)	FS 1490 (7 IP)	FS 1490 (7 IP)
Support plate for basic shape CN .. 1207 ..									AP411-CN1207
Support plate for basic shape DN .. 1507 ..									AP412-DN1507
Support plate for basic shape SN .. 1207 ..									AP413-SN1207

* for inserts with a hole (dimple)
** for ceramic inserts without a hole

Walter Turn clamp holders have been used to mount the PK 241 set as standard. By using the PK 254 set, the following ceramic inserts without a hole can be clamped: CN .. 12 .. / DN .. 15 .. / SN .. 12 .. → For this, separate support plates must be ordered (see table).

Usage information: Coolant nozzles and coolant adaptors

Coolant nozzles – Walter Capto™

		Capto sizes		
		C3 + C4	C5 + C6	C6 + C 8
	Standard coolant nozzle up to 30 bar	FS 1477	FS 1476	FS 1479
	Brass high-pressure coolant nozzle up to 80 bar	FS 1477HP	FS 1476HP	FS 1479HP
	Plug-in inserts for changing the nozzles	FS 1477HEX (SW5)	FS 1476HEX (SW5)	FS 1479HEX (SW5)
	Key for plug-in insert	FS 2158 (SW5)	FS 2158 (SW5)	FS 2158 (SW5)

Please note:

A different coolant nozzle is installed in certain Walter Capto™ tools (C3–C8) from the one specified in the table above. This detailed information can be found on the relevant tool page.

Coolant adaptor K600 for Walter Turn boring bars with screw or rigid clamping system

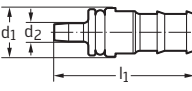
	Designation	d ₁ mm	l ₁ mm	d ₂ mm
	K600.06.25.054	6	25	5,4
	K600.08.28.066	8	28	6,6
	K600.10.28.086	10	28	8,6
	K600.12.38.086	12	38	8,6
	K600.16.40.137	16	40	13,7
	K600.20.40.137	20	40	13,7
	K600.25.44.137	25	44	13,7
	K600.32.44.137	32	44	13,7
	K600.40.46.137	40	46	13,7
	K600.50.46.137	50	46	13,7

Comment: d₁ corresponds to the shank diameter of the boring bar.

Please note:

Coolant adaptors can be cut off if necessary, approx. 3 mm after the O-ring. This makes shorter clamping possible when using the boring bar and coolant adaptor in a Walter Capto™ or VDI boring bar holder. Furthermore, the exit of coolant via the clamping surface is avoided, and a higher pressure is also available for the internal supply of coolant.

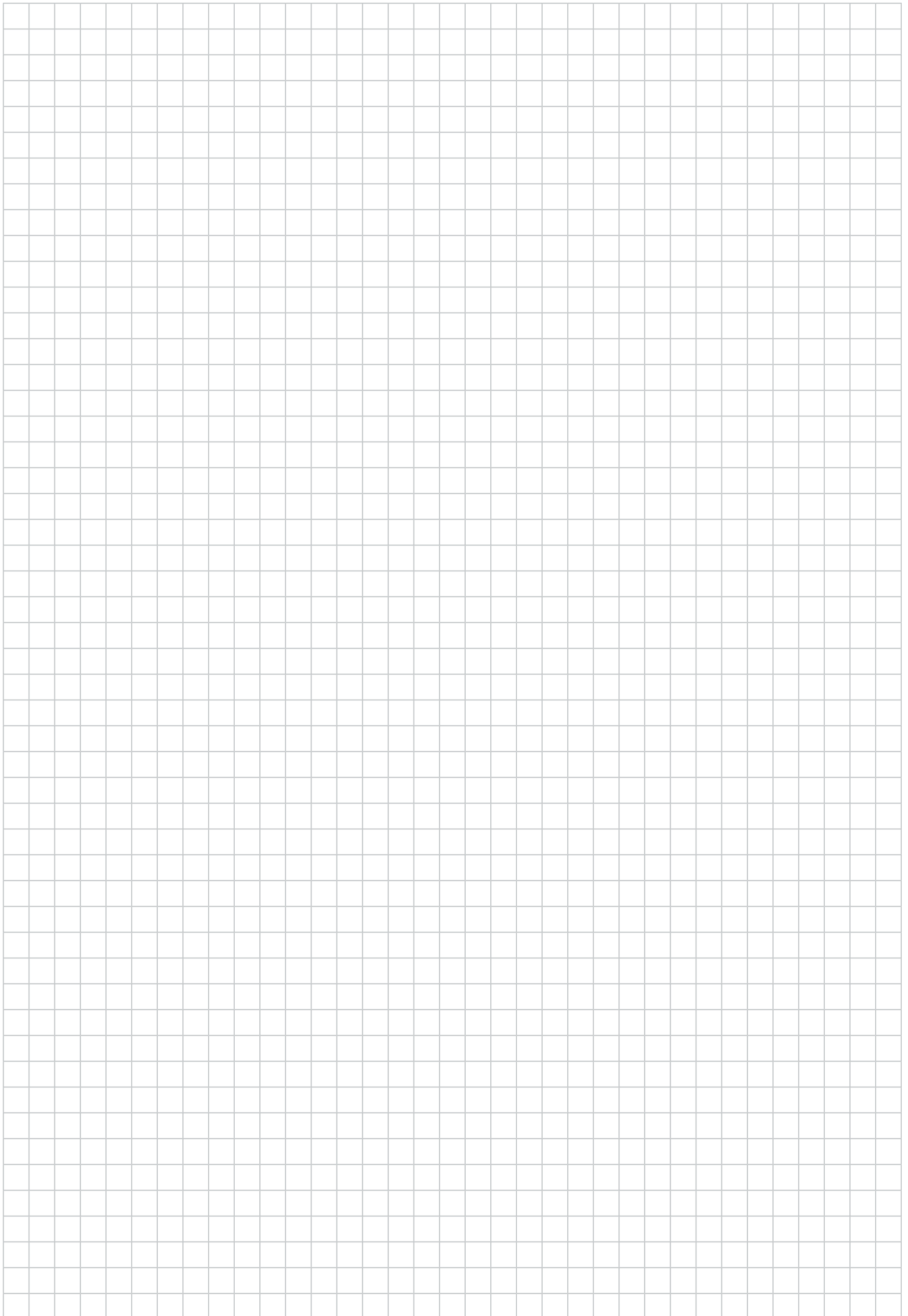

Cutting data for Walter Cut – Grooving and recessing Carbide grades

Material group	Structure of main material groups and identification letters		Brinell hardness HB	Tensile strength R _m N/mm ²	Machining group ¹			Cutting material grades			
								Starting values for cutting speed v _c [m/min]			
								HC			
							WPP23	WSM13S			
P	Unalloyed steel	C ≤ 0.25%	annealed	125	428	P1	●●	●	200	200	
		C > 0.25... ≤ 0.55%	annealed	190	639	P2	●●	●	180	180	
		C > 0.25... ≤ 0.55%	tempered	210	708	P3	●●	●	170	170	
		C > 0.55%	annealed	190	639	P4	●●	●	180	190	
		C > 0.55%	tempered	300	1013	P5	●●	●	150	160	
		Free cutting steel (short-chipping)	annealed	220	745	P6	●●	●	180	190	
	Low-alloyed steel		annealed	175	591	P7	●●	●	180	190	
			tempered	300	1013	P8	●●	●	150	160	
			tempered	380	1282	P9	●●	●	150	160	
			tempered	430	1477	P10	●●	●			
High-alloyed steel and high-alloyed tool steel		annealed	200	675	P11	●●	●	130	140		
		hardened and tempered	300	1013	P12	●●	●	110	120		
		hardened and tempered	400	1361	P13	●●	●				
Stainless steel		ferritic/martensitic, annealed	200	675	P14	●●	●			190	
		martensitic, tempered	330	1114	P15	●●	●			120	
M	Stainless steel		austenitic, quench hardened	200	675	M1	●●	●			190
			austenitic, precipitation hardened (PH)	300	1013	M2	●●	●			120
			austenitic/ferritic, duplex	230	778	M3	●●	●			170
K	Malleable cast iron		ferritic	200	675	K1	●●	●	190	190	
			pearlitic	260	867	K2	●●	●	170	170	
	Grey cast iron		low tensile strength	180	602	K3	●●	●	250	220	
			high tensile strength/austenitic	245	825	K4	●●	●	210	180	
	Cast iron with spheroidal graphite		ferritic	155	518	K5	●●	●	220	220	
			pearlitic	265	885	K6	●●	●	180	180	
	GGV (CGI)		200	675	K7	●●	●	200			
N	Aluminium wrought alloys		cannot be hardened	30	–	N1	●●	●			
			hardenable, hardened	100	343	N2	●●	●			
	Cast aluminium alloys		≤ 12% Si, cannot be hardened	75	260	N3	●●	●			
			≤ 12% Si, hardenable, hardened	90	314	N4	●●	●			
			> 12% Si, cannot be hardened	130	447	N5					
	Magnesium alloys			70	250	N6					
	Copper and copper alloys (bronze/brass)		unalloyed, electrolytic copper	100	343	N7	●●	●			
		brass, bronze, red brass	90	314	N8	●●	●				
		Cu-alloys, short-chipping	110	382	N9	●●	●				
		high-strength, Ampco	300	1013	N10						
S	Heat-resistant alloys	Fe-based	annealed	200	675	S1	●●	●			110
			hardened	280	943	S2	●●	●			60
		Ni or Co base	annealed	250	839	S3	●●	●			90
			hardened	350	1177	S4	●●	●			80
			cast	320	1076	S5	●●	●			80
	Titanium alloys		pure titanium	200	675	S6	●●	●			160
			α and β alloys, hardened	375	1262	S7	●●	●			45
			β alloys	410	1396	S8	●●	●			35
Tungsten alloys			300	1013	S9						
Molybdenum alloys			300	1013	S10						
H	Hardened steel		hardened and tempered	50 HRC	–	H1					
			hardened and tempered	55 HRC	–	H2					
			hardened and tempered	60 HRC	–	H3					
	Hardened cast iron		hardened and tempered	55 HRC	–	H4					
O	Thermoplasts		without abrasive fillers			O1					
	Thermosetting plastics		without abrasive fillers			O2					
	Plastic, glass-fibre reinforced		GFRP			O3					
	Plastic, carbon-fibre reinforced		CFRP			O4					
	Plastic, aramid-fibre reinforced		AFRP			O5					
	Graphite (technical)			80 Shore			O6				

- Recommended application (the specified cutting data are regarded as starting values for the recommended application)
- Possible application

¹ The classification of the machining groups can be found in the Walter General catalogue 2012 from page H 8 onwards.

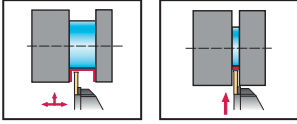

The specified cutting data are average recommended values.
For special applications, adjustment is recommended.

Cutting material grades

Starting values for cutting speed
 v_c [m/min]

	HC										HW WK1
	WSM23S	WSM33S	WSM43S	WSM33	WSP43	WTA33	WAM20	WXM33	WAK20	WAK30	
	190	180	170	180	170	190		180	190	180	
	170	170	160	170	160	180		180	180	170	
	160	150	140	150	140	160		160	170	160	
	180	170	160	170	160	180		180	180	170	
	150	140	130	140	130	120		100	160	150	
	180	170	160	170	160	180		180	180	170	
	180	160	150	160	150	180		160	180	160	
	150	110	100	110	100	150		130	160	150	
	150	100	100	100	100	130		90	150	130	
									80	60	
	130	120	110	120	110	180		100	180	160	
	110	90	80	90	80	140			160	140	
									80	60	
	180	160	140	160	140	180	180	170	200	180	
	100	80	60	80	60	100	110	80	130	110	
	170	150	130	150	130	150	160	140			
	100	80	60	80	60	100	110	80	130	110	
	150	130	110	130	110	130	140	120			
	180	170		170		100			160	140	
	160	150		150		60			130	100	
	210	200		220		260			350	330	
	170	160		180		210			310	290	
	210	200		200		240			300	280	
	170	160		160		190			260	240	
									220	180	
											900
											600
											350
											250
											400
											300
											200
	100	90	80	90	80						
	50	40	30	40	30						
	80	70	60	70	60						
	70	60	50	60	50						
	70	60	50	60	50						
	150	130	120	130	120						
	40	35	30	35	30						
	30	25		25							

HC = Coated carbide
HW = Uncoated carbide

Cutting data for Walter Cut – Parting off Carbide grades

Material group	Structure of main material groups and identification letters		Brinell hardness HB	Tensile strength R_m N/mm ²	Machining group ¹			
P	Unalloyed steel	C ≤ 0.25%	annealed	125	428	P1	●●	●
		C > 0.25... ≤ 0.55%	annealed	190	639	P2	●●	●
		C > 0.25... ≤ 0.55%	tempered	210	708	P3	●●	●
		C > 0.55%	annealed	190	639	P4	●●	●
		C > 0.55%	tempered	300	1013	P5	●●	●
		Free cutting steel (short-chipping)	annealed	220	745	P6	●●	●
	Low-alloyed steel		annealed	175	591	P7	●●	●
			tempered	300	1013	P8	●●	●
			tempered	380	1282	P9	●●	●
			tempered	430	1477	P10		
	High-alloyed steel and high-alloyed tool steel		annealed	200	675	P11	●●	●
			hardened and tempered	300	1013	P12	●●	●
			hardened and tempered	400	1361	P13		
	Stainless steel		ferritic/martensitic, annealed	200	675	P14	●●	●
			martensitic, tempered	330	1114	P15	●●	●
M	Stainless steel	austenitic, quench hardened	200	675	M1	●●	●	
		austenitic, precipitation hardened (PH)	300	1013	M2	●●	●	
		austenitic/ferritic, duplex	230	778	M3	●●	●	
K	Malleable cast iron	ferritic	200	675	K1	●●	●	
		pearlitic	260	867	K2	●●	●	
	Grey cast iron	low tensile strength	180	602	K3	●●	●	
		high tensile strength/austenitic	245	825	K4	●●	●	
	Cast iron with spheroidal graphite	ferritic	155	518	K5	●●	●	
		pearlitic	265	885	K6	●●	●	
	GGV (CGI)		200	675	K7	●●	●	
N	Aluminium wrought alloys	cannot be hardened	30	–	N1	●●	●	
		hardenable, hardened	100	343	N2	●●	●	
	Cast aluminium alloys	≤ 12% Si, cannot be hardened	75	260	N3	●●	●	
		≤ 12% Si, hardenable, hardened	90	314	N4	●●	●	
		> 12% Si, cannot be hardened	130	447	N5			
	Magnesium alloys		70	250	N6			
	Copper and copper alloys (bronze/brass)		unalloyed, electrolytic copper	100	343	N7	●●	●
			brass, bronze, red brass	90	314	N8	●●	●
			Cu-alloys, short-chipping	110	382	N9	●●	●
			high-strength, Ampco	300	1013	N10		
S	Heat-resistant alloys	Fe-based	annealed	200	675	S1	●●	●
			hardened	280	943	S2	●●	●
		Ni or Co base	annealed	250	839	S3	●●	●
			hardened	350	1177	S4	●●	●
			cast	320	1076	S5	●●	●
	Titanium alloys		pure titanium	200	675	S6	●●	●
			α and β alloys, hardened	375	1262	S7	●●	●
			β alloys	410	1396	S8	●●	●
	Tungsten alloys		300	1013	S9			
	Molybdenum alloys		300	1013	S10			
H	Hardened steel		hardened and tempered	50 HRC	–	H1		
			hardened and tempered	55 HRC	–	H2		
			hardened and tempered	60 HRC	–	H3		
	Hardened cast iron		hardened and tempered	55 HRC	–	H4		
O	Thermoplasts		without abrasive fillers			O1		
	Thermosetting plastics		without abrasive fillers			O2		
	Plastic, glass-fibre reinforced		GFRP			O3		
	Plastic, carbon-fibre reinforced		CFRP			O4		
	Plastic, aramid-fibre reinforced		AFRP			O5		
	Graphite (technical)			80 Shore		O6		

- Recommended application (the specified cutting data are regarded as starting values for the recommended application)
- Possible application

¹ The classification of the machining groups can be found in the Walter General catalogue 2012 from page H 8 onwards.

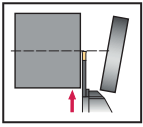

The specified cutting data are average recommended values.
For special applications, adjustment is recommended.

Cutting material grades									
Starting values for cutting speed v _c [m/min]									
HC									HW
WPP23	WSM13S	WSM23S	WSM33S	WSM43S	WSM33	WSP43	WAM20	WXM33	WK1
190	190	180	170	160	170	160		170	
170	180	170	160	150	160	150		170	
160	160	150	140	130	140	130		150	
170	180	170	160	150	160	150		170	
140	150	140	130	120	130	120		90	
170	180	170	160	150	160	150		170	
170	180	170	150	140	150	140		150	
140	150	140	100	90	100	90		120	
140	150	140	90	90	90	90		80	
120	130	120	110	100	110	100		90	
100	110	100	80	70	80	70			
	180	170	150	130	150	130	170	160	
	100	90	70	50	70	50	100	70	
	170	160	140	120	140	120	150	130	
	100	90	70	50	70	50	100	70	
	150	140	120	100	120	100	130	110	
180	180	170	160		160				
160	160	150	140		140				
230	230	220	210		210				
190	190	180	170		170				
210	210	200	190		190				
170	170	160	150		150				
190									
									900
									600
									350
									250
									400
									300
									200
	100	90	80	70	80	70	70		
	50	40	30	25	30	20	20		
	80	70	60	50	60	50	50		
	70	60	50	40	50	40	40		
	70	60	50	40	50	40	40		
	150	140	130	110	130	120	120		
	50	40	30	25	30	25	25		
	40	30	25		25	20	20		

HC = Coated carbide
HW = Uncoated carbide









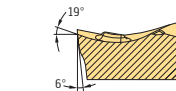

Cutting tool material application tables – Grooving

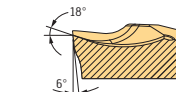

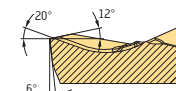
Walter grade designation	Standard designation	Workpiece material group							Application range						Coating procedure	Coating composition	Indexable insert example
		P	M	K	N	S	H	O	01	10	20	30	40				
		Steel	Stainless steel	Cast iron	NF metals	Difficult-to-cut materials	Hard materials	Other	05	15	25	35	45				
WPP 23	HC – P 20	●●								[Application range: 10-30]				CVD	TiCN + Al ₂ O ₃ (+TiN)		
	HC – K 30			●						[Application range: 25-35]							
WSM 13S	HC – M 10		●●						[Application range: 05-15]				PVD	TiAlN + Al ₂ O ₃ (Al)			
	HC – S 10					●●			[Application range: 05-15]								
	HC – P 10	●							[Application range: 10-15]								
WSM 23S	HC – M 20		●●						[Application range: 10-20]				PVD	TiAlN + Al ₂ O ₃ (Al)			
	HC – S 20					●●			[Application range: 10-20]								
	HC – P 20	●●							[Application range: 15-20]								
WSM 33S	HC – S 30					●●			[Application range: 20-30]				PVD	TiAlN + Al ₂ O ₃ (Al)			
	HC – M 30		●●						[Application range: 20-30]								
	HC – P 35	●●							[Application range: 25-35]								
WSM 43S	HC – S 45					●●			[Application range: 35-45]				PVD	TiAlN + Al ₂ O ₃ (Al)			
	HC – M 45		●●						[Application range: 35-45]								
	HC – P 45	●●							[Application range: 40-45]								
WSM 33	HC – S 30					●●			[Application range: 20-30]				PVD	TiAlN + Al ₂ O ₃ (ZrCN)			
	HC – M 30		●●						[Application range: 20-30]								
	HC – P 35	●●							[Application range: 25-35]								
WSP 43	HC – S 45					●●			[Application range: 35-45]				PVD	TiAlN + Al ₂ O ₃ (ZrCN)			
	HC – P 45	●●							[Application range: 40-45]								
	HC – M 45		●●						[Application range: 35-45]								
WAK 20	HC – K 20			●●					[Application range: 15-25]				CVD	TiCN + Al ₂ O ₃ (+TiN)			
	HC – H 10						●		[Application range: 05-10]								
WAK 30	HC – K 30			●●					[Application range: 20-30]				CVD	TiCN + Al ₂ O ₃ (+TiN)			
	HC – P 40	●							[Application range: 30-35]								
WK 1	HW – N 10				●●				[Application range: 10-15]				-	-			
	HW – S 10					●			[Application range: 05-10]								
WTA 33	HC – P 10	●●							[Application range: 10-15]				CVD	TiCN + Al ₂ O ₃			
	HC – K 10			●					[Application range: 10-15]								

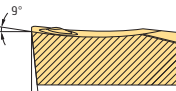
HC = Coated carbide
HW = Uncoated carbide

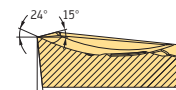
●● Primary application
● Other application

Geometry overview of cutting inserts

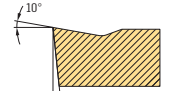
GX system for grooving and parting off											
Geometry	Remarks/ field of applications	Workpiece material group						Section through main cutting edge	Front view Main cutting edge	s [mm]	f [mm]
		P	M	K	N	S	H				
		Steel	Stainless steel	Cast iron	NF metals	Difficult-to-cut materials	Hard materials	Other			
 <p>CF6 – Low feeds – Low burr/centre pip formation – Low cutting force</p>		••	••		••	••		•	 	1,5	0,03–0,10
		••	••		••	••				2	0,03–0,12
		••	••		••	••				2,5	0,03–0,15
		••	••		••	••				3	0,04–0,20
 <p>CF5 – Grooving and parting off operations – Light to moderate feeds – Good chip control – Low burr/centre pip formation</p>		••	••	•	••	••		•	 	2	0,04–0,15
		••	••	•	••	••				2,5	0,05–0,15
		••	••	•	••	••				3	0,08–0,20
		••	••	•	••	••				4	0,10–0,22
 <p>CE4 – Grooving and parting off operations – Moderate to high feeds – Excellent chip constriction – Stable cutting edge</p>		••	•	••	•	•		•	 	2	0,06–0,15
		••	•	••	•	•				2,5	0,07–0,18
		••	•	••	•	•				3	0,09–0,30
		••	•	••	•	•				4	0,10–0,32
 <p>GD3 – Extremely soft cutting action – Light to moderate feeds – General parting off and grooving operations</p>		••	••	•	•	•		•	 	2	0,04–0,12
		••	••	•	•	•				2,5	0,04–0,14
		••	••	•	•	•				3	0,06–0,18
		••	••	•	•	•				4	0,10–0,20
 <p>GD6 – Medium feeds – Long-chipping materials – Medium machining conditions</p>		••	••	•	•	••			 	2	0,04–0,12
		••	••	•	•	••				2,5	0,06–0,17
		••	••	•	•	••				3	0,08–0,18
		••	••	•	•	••				4	0,10–0,22
		••	••	•	•	••			5	0,12–0,24	
		••	••	•	•	••			6	0,14–0,30	







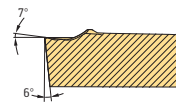

GX system for grooving of circlip grooves											
Geometry	Remarks/ field of applications	Workpiece material group						Section through Main cutting edge	Front view Main cutting edge	s [mm]	f [mm]
		P	M	K	N	S	H				
		Steel	Stainless steel	Cast iron	NF metals	Difficult-to-cut materials	Hard materials	Other			
 <p>Cutting inserts for circlip grooves – Excellent surface quality – All common circlip types – Low burr formation</p>		••	•	••					 	0,6-1,99	0,05–0,10
		••	•	••						2-2,99	0,05–0,12
		••	•	••						3-3,99	0,07–0,14
		••	•	••						4-4,99	0,07–0,20
		••	•	••						5-5,99	0,08–0,20

- Primary application
- Other application

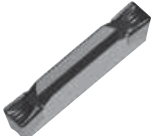
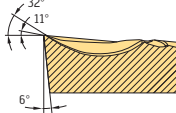
Geometry overview of cutting inserts

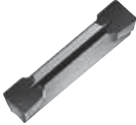
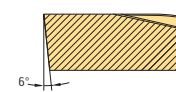

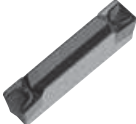
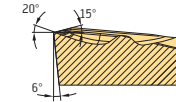



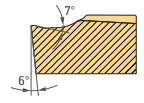

(continued)

GX system for grooving, parting off and recessing

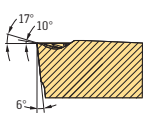
Geometry	Remarks/ field of applications	Workpiece material group							Section through main cutting edge	Front view Main cutting edge	s [mm]	a _p [mm]	f [mm]
		P Steel	M Stainless steel	K Cast iron	N NF metals	S Difficult-to-cut materials	H Hard materials	O Other					
 <p>UD4 – Large chip breaking area – Optimum chip breaking when machining forged parts – Stable cutting edge – For moderate to high feeds</p>		●●	●	●●						3	0,4–2,0	0,08–0,20	
										4	0,5–2,8	0,10–0,30	
										5	0,5–3,0	0,12–0,35	
										6	0,6–3,5	0,14–0,40	
										8	0,9–4,0	0,14–0,40	
 <p>UF4 – All grooving operations – Good chip control – Average feed range – Positive cut</p>		●●	●●	●●	●					2	0,30–2,50	0,10–0,15	
										2,5	0,30–2,50	0,10–0,18	
										3	0,40–3,00	0,10–0,20	
										4	0,50–3,50	0,10–0,30	
										5	0,50–3,50	0,12–0,35	
										6	0,60–4,00	0,14–0,40	
 <p>UA4 – For cast iron machining – For middle to high machining parameters – For extremely high level of process reliability in cast iron machining</p>					●					2	0,30–2,50	0,08–0,15	
										2,5	0,30–2,50	0,10–0,20	
										3	0,40–3,00	0,10–0,22	
										4	0,50–3,50	0,10–0,35	
										5	0,50–3,00	0,12–0,35	
										6	0,60–3,50	0,14–0,40	
 <p>UD6 – Grooving in rust-resistant steel – Average feed range – Soft cutting action</p>		●	●●							2	0,30–2,50	0,06–0,15	
										2,5	0,30–2,50	0,08–0,14	
										3	0,40–3,00	0,10–0,20	
										4	0,50–3,50	0,12–0,25	
										5	0,50–3,00	0,12–0,30	
										6	0,60–3,50	0,14–0,35	

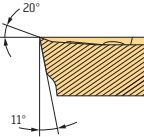
●● Primary application
● Other application

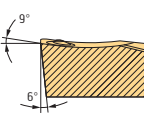
GX system, full radius cutting inserts

Geometry	Remarks/ field of applications	Workpiece material group							Section through main cutting edge	Front view Main cutting edge	s [mm]	a _p [mm] max	f [mm]
		P Steel	M Stainless steel	K Cast iron	N NF metals	S Difficult-to-cut materials	H Hard materials	O Other					
 <p>RD4 – For copy turning – Outstanding chip control during grooving – For moderate to high feeds – Circumference-sintered</p>		●●	●	●●	●					3	1,50	0,08–0,35	
		4	2,00	0,10–0,40									
		5	2,50	0,12–0,50									
		6	3,00	0,15–0,60									
 <p>RF8 – For copy and back turning – Fully ground circumference – High surface quality – Stable cutting edge</p>		●●	●●	●	●●				3	0,1–1,5	0,10–0,30		
		4	0,1–2,0	0,12–0,45									
		5	0,1–2,5	0,15–0,50									
		6	0,1–3,0	0,15–0,55									
 <p>RK8 – Polished rake face – Sharp cutting edge – Fully ground circumference – Extremely positive</p>					●●	●			6	4,00	0,10–0,30		
		8	5,00	0,10–0,35									
 <p>R – Sharp cutting edge – Fully ground circumference – High surface quality</p>		●●	●						1,6	0,80	0,05–0,15		
		2	1,00	0,05–0,17									
		2,4	1,20	0,05–0,17									
		3	1,50	0,10–0,20									
		4	2,00	0,10–0,30									
		5	2,50	0,15–0,35									
6	3,00	0,15–0,40											

- Primary application
- Other application

LX system for grooving, parting off and recessing

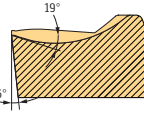
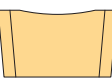

Geometry	Remarks/ field of applications	Workpiece material group							Section through main cutting edge	Front view Main cutting edge	s [mm]	a _p [mm]	f [mm]
		P Steel	M Stainless steel	K Cast iron	N NF metals	S Difficult-to-cut materials	H Hard materials	O Other					
 <p>UE4 – For grooving and recessing – Outstanding chip control – Moderate to high feeds</p>		●●	●	●●	●					8	0,90–5,00	0,20–0,50	

- Primary application
- Other application

Geometry overview of cutting inserts



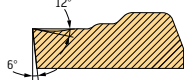



(continued)

LX system, full radius cutting inserts

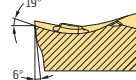
Geometry	Remarks/ field of applications	Workpiece material group							Section through main cutting edge	Front view Main cutting edge	s [mm]	a _p [mm] max	f [mm]
		P Steel	M Stainless steel	K Cast iron	N NF metals	S Difficult-to-cut materials	H Hard materials	O Other					
	RD3 – For copy turning – Stable cutting edge – For moderate to high feeds	●●	●	●●	●	●					8	4,00	0,15–0,50
		●●	●	●●	●	●							

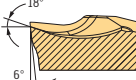

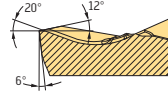



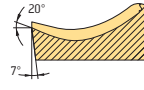

●● Primary application
 ● Other application

SX system for grooving and parting off

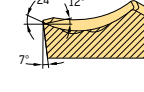
Geometry	Remarks/ field of applications	Workpiece material group							Section through main cutting edge	Front view Main cutting edge	s [mm]	f [mm]
		P Steel	M Stainless steel	K Cast iron	N NF metals	S Difficult-to-cut materials	H Hard materials	O Other				
	CF6 – Low feeds – Low burr/centre pip formation – Low cutting force	●●	●●		●●	●●					2	0,03–0,12
											3	0,04–0,20
	CF5 – Grooving and parting off operations – Light to moderate feeds – Good chip control – Low burr/centre pip formation	●●	●●	●	●●	●●					2	0,04–0,15
											3	0,08–0,20
											4	0,10–0,20
											5	0,10–0,25
											6	0,12–0,28
	CE4 – Grooving and parting off operations – Moderate to high feeds – Excellent chip constriction – Stable cutting edge	●●	●	●●	●	●	●				2	0,06–0,15
											3	0,09–0,30
											4	0,10–0,32
											5	0,12–0,35
											6	0,12–0,40

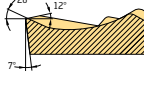
●● Primary application
 ● Other application

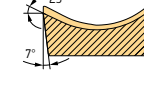
FX system for grooving and parting off

Geometry	Remarks/ field of applications	Workpiece material group							Section through main cutting edge	Front view Main cutting edge	s [mm]	f [mm]
		P Steel	M Stainless steel	K Cast iron	N NF metals	S Difficult-to-cut materials	H Hard materials	O Other				
	CE6 – Light to moderate feeds – Long-chipping materials – Low centre pip formation	●●	●●	●		●●					2,2	0,05–0,15
											3,1	0,06–0,25
											4,1	0,08–0,25
	CD3 – Unfavourable machining conditions – Average feed range – Machining steel	●●	●●	●●						3,1	0,10–0,30	
											4,1	0,15–0,35
	CE4 – Grooving and parting off operations – Moderate to high feeds – Excellent chip constriction	●●	●	●●						2,2	0,05–0,15	
											3,1	0,09–0,30
											4,1	0,10–0,32
											5,1	0,12–0,35
											6,5	0,12–0,40
											8,2	0,15–0,45
							9,7	0,15–0,50				
	CK8 – For small and moderate feeds – Polished rake face – Highly positive geometry				●●	●				2,2	0,05–0,10	
											3,1	0,05–0,15
											4,1	0,05–0,20

- Primary application
- Other application

Usage information: Replacing the cutting edge on Walter Cut tools

Mounting SX cutting inserts

Fitting the cutting insert

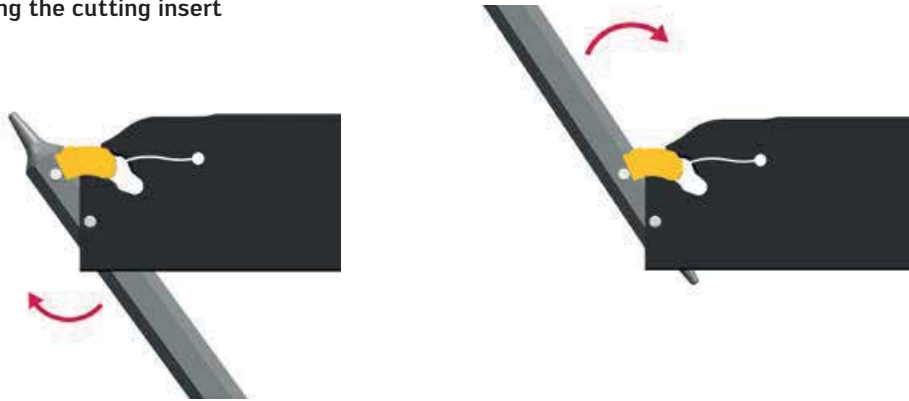

Removing the cutting insert

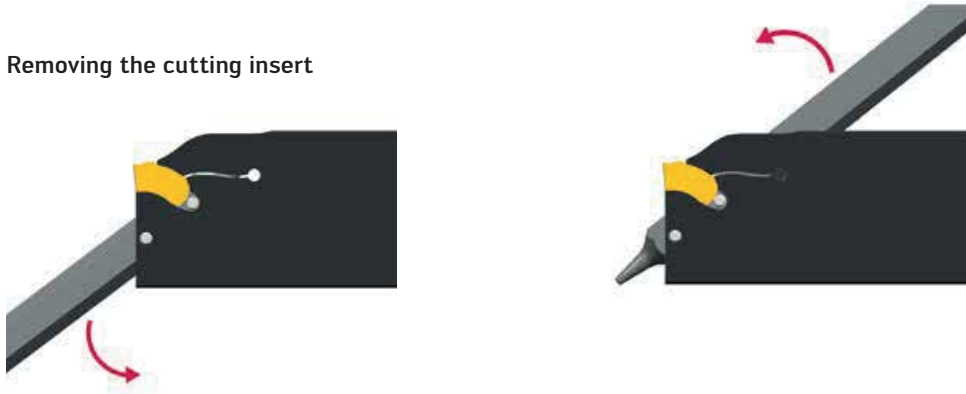

Mounting wrench	For groove width
FS 2249	1,0–1,99 mm
FS 1494	2,0–6,0 mm

Mounting wrench must be ordered separately.

Usage information: Walter Cut tool standard/contra version

G2042 / G1041 / G1041 . . . –C

Right-hand version



Standard

Example: G1041.32R–3T32GX24



Contra

Example: G1041.32R–3T32GX24C

Left-hand version



Standard

Example: G1041.32L–3T32GX24



Contra

Example: G1041.32L–3T32GX24C

Usage information: Coolant hose set for grooving holders with internal coolant supply

Grooving holder G2012-P

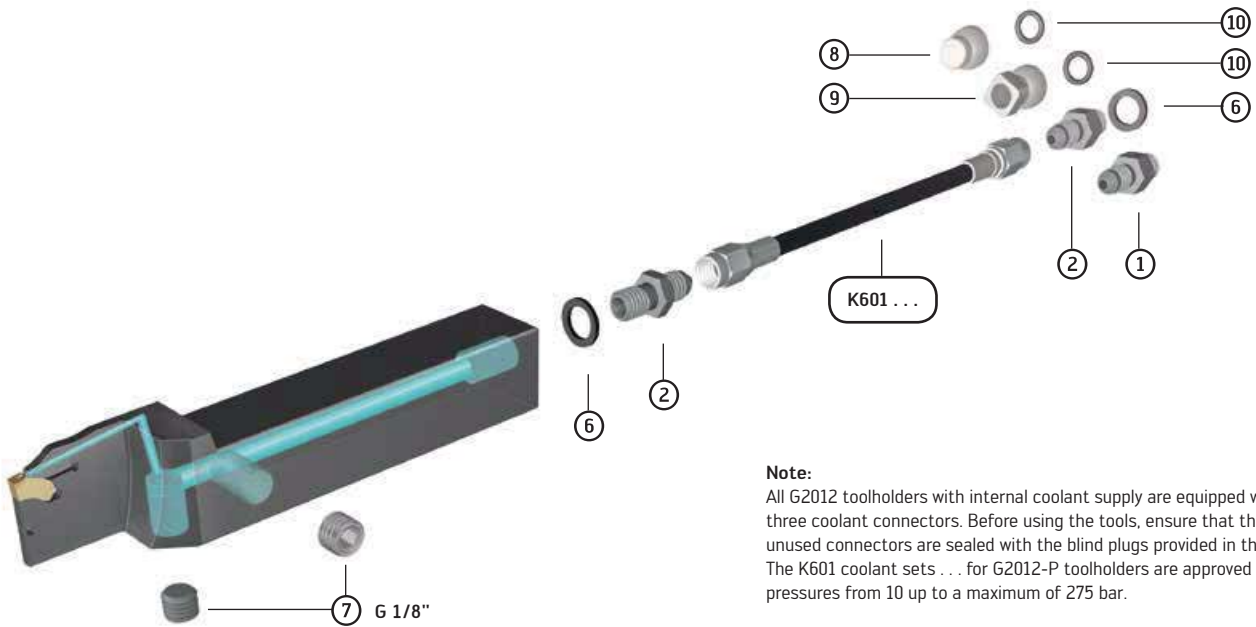

Note:
All G2012 toolholders with internal coolant supply are equipped with three coolant connectors. Before using the tools, ensure that the unused connectors are sealed with the blind plugs provided in the set. The K601 coolant sets ... for G2012-P toolholders are approved for pressures from 10 up to a maximum of 275 bar.

Walter P coolant hose set

Individual components	Designation	Length		
		150 mm	250 mm	300 mm
		K601.01.150 SET	K601.02.150 SET	K601.03.150 SET
		K601.01.250 SET	K601.02.250 SET	K601.03.250 SET
		K601.01.300 SET	K601.02.300 SET	K601.03.300 SET
		Number per set		
①	M10 connection element FS2252	1 x	—	—
②	1/8" double connection element FS2253	2 x	1 x	—
③	1/8" angle connection FS2254	—	1 x	1 x
④	M10 angle connection FS2255	—	1 x	2 x
⑤	1/4" – 1/8" reduction adaptor FS2256	—	1 x	1 x
⑥	Copper gasket FS2257	2 x	3 x	4 x
⑦	1/8" blind plug FS2258	1 x	1 x	1 x
⑧	Brass blind plug FS2259	1 x	1 x	1 x
⑨	1/8" brass nozzle FS2260	1 x	1 x	1 x
⑩	O-ring FS2261	2 x	2 x	2 x



Drilling and reaming tools made from solid carbide and HSS

	Page	
Walter Titex drilling and reaming tools	Product range overview	B-2
	Walter Select – Drilling	B-8
	Walter Titex drills	B-26
	Walter Select – Core drilling, countersinking and centring	B-78
	Walter Titex core drilling, countersinking and centring tools	B-84
	Walter Select – Reaming	B-86
	Walter Titex reaming tools	B-92
Technical information	Cutting data	B-102
	RPM diagrams VCRR	B-122
	Feed rate charts VRR	B-124
	Cutting tool materials, surface treatment and coatings	B-126
	Tool types	B-128
	XD technology, deep hole drilling strategy	B-132

Product range overview of solid carbide drills with internal cooling

Application									
Drilling depth	3 x D _c		3 x D _c				5 x D _c		
Designation	K3299XPL	K3899XPL	A3289DPL	A3293TTP	A3299XPL	A3899XPL	A3389AML	A3389DPL	A3393TTP
Type	X-treme Step 90	X-treme Step 90	X-treme Plus	X-treme Inox	X-treme	X-treme	X-treme M	X-treme Plus	X-treme Inox
Ø range	3,30 – 14,00	3,30 – 14,00	3,00 – 20,00	3,00 – 20,00	3,00 – 20,00	3,00 – 20,00	2,00 – 2,95	3,00 – 20,00	3,00 – 20,00
Page	B-75	B-77	<i>B 70*</i>	B-30	B-33	B-54	B-41	<i>B 86*</i>	B-42

Application									
Drilling depth	5 x D _c					8 x D _c			
Designation	A3382XPL	A3399XPL	A3999XPL	A3387	A3384	A6489AMP	A6488TML	A6489DPP	A3487
Type	X-treme CI	X-treme	X-treme	Alpha® Jet	Alpha® Ni	X-treme DM8	Alpha® 4 Plus Micro	X-treme D8	Alpha® Jet
Ø range	3,00 – 20,00	3,00 – 25,00	3,00 – 25,00	4,00 – 20,00	3,00 – 12,00	2,00 - 2,95	0,75 – 1,95	3,00 – 20,00	5,00 – 20,00
Page	<i>B 81*</i>	B-45	B-62	<i>B 85*</i>	<i>B 84*</i>	B-67	<i>B 121*</i>	<i>B 123*</i>	<i>B 95*</i>

Application								
Drilling depth	8 x D _c		12 x D _c				16 x D _c	
Designation	A3486TIP	A3586TIP	A6589AMP	A6588TML	A6589DPP	A3687	A6689AMP	A6685TFP
Type	Alpha® 44	Alpha® 44	X-treme DM12	Alpha® 4 Plus Micro	X-treme D12	Alpha® Jet	X-treme DM16	Alpha® 4 XD16
Ø range	5,00 – 12,00	5,00 – 12,00	2,00 - 2,90	1,00 – 1,90	3,00 – 20,00	5,00 – 20,00	2,00 – 2,90	3,00 – 16,00
Page	<i>B 94*</i>	<i>B 96*</i>	B-68	<i>B 126*</i>	<i>B 127*</i>	<i>B 97*</i>	B-69	<i>B 130*</i>

* The pages indicated in italics refer to the Walter General catalogue 2012.

Product range overview of solid carbide drills with internal cooling

Application									
Drilling depth	20 x D _c			25 x D _c		30 x D _c			40 x D _c
Designation	A6789AMP	A6794TFP	A6785TFP	A6889AMP	A6885TFP	A6989AMP	A6994TFP	A6985TFP	A7495TTP
Type	X-treme DM20	X-treme DH20	Alpha® 4 XD20	X-treme DM25	Alpha® 4 XD25	X-treme DM30	X-treme DH30	Alpha® 4 XD30	X-treme D40
Ø range	2,00 – 2,90	3,00 – 10,00	3,00 – 16,00	2,00 – 2,90	3,00 – 12,00	2,00 – 2,90	3,00 – 10,00	3,00 – 12,00	4,50 – 11,00
Page	B-70	<i>B 133*</i>	<i>B 131*</i>	B-71	<i>B 134*</i>	B-72	<i>B 137*</i>	<i>B 136*</i>	B-73

Application					
Drilling depth	Pilot				
Designation	K3281TFT	A6181AML	A6181TFT	A7191TFT	K5191TFT
Type	X-treme Pilot Step 90	X-treme Pilot 150	XD Pilot	X-treme Pilot 180	X-treme Pilot 180C
Ø range	3,00 – 16,00	2,00 – 2,95	3,00 – 16,00	3,00 – 10,00	4,00 – 7,00
Page	B-74	B-66	<i>B 118*</i>	<i>B 138*</i>	<i>B 140*</i>

* The pages indicated in italics refer to the Walter General catalogue 2012.

Product range overview of solid carbide drills without internal cooling

Application										
Drilling depth	3 x D _C	3 x D _C								
Designation	K3879XPL	A3279XPL	A3879XPL	A3269TFL	A1164TIN	A1163	A1166TIN	A1166	A1167A	A1167B
Type	X-treme Step 90	X-treme	X-treme	Alpha® Rc	Alpha® 2	N	Maximiza	Maximiza	Maximiza	Maximiza
Ø range	3,30 – 14,50	3,00 – 20,00	3,00 – 20,00	3,40 – 10,40	1,50 – 20,00	1,00 – 12,00	3,00 – 20,00	3,00 – 20,00	3,00 – 20,00	3,00 – 20,00
Page	<i>B-76</i>	<i>B-26</i>	<i>B-50</i>	<i>B 65*</i>	<i>B 38*</i>	<i>B 36*</i>	<i>B 46*</i>	<i>B 42*</i>	<i>B 47*</i>	<i>B 50*</i>

Application									
Drilling depth	5 x D _C						8 x D _C		
Designation	A3378TML	A3162	A3379XPL	A3979XPL	A3367	A3967	A6478TML	A1276TFL	A1263
Type	Alpha® 2 Plus Micro	ESU	X-treme	X-treme	BSX	BSX	Alpha® 2 Plus Micro	Alpha® 22	N
Ø range	0,50 – 2,95	0,10 – 1,45	3,00 – 25,00	3,00 – 25,00	3,00 – 16,00	3,00 – 16,00	0,50 – 2,95	3,00 – 12,00	0,60 – 12,00
Page	<i>B 79*</i>	<i>B 59*</i>	<i>B-37</i>	<i>B-58</i>	<i>B 77*</i>	<i>B 110*</i>	<i>B 119*</i>	<i>B 57*</i>	<i>B 55*</i>

Application			
Drilling depth	3 x D _C – Carbide-tipped		NC spot drill
Designation	A2971	A5971	A1174 A1174C
Type	HM	HM	90° 120°
Ø range	3,00 – 16,00	8,00 – 32,00	3,00 – 20,00 3,00 – 20,00
Page	<i>B 58*</i>	<i>B 116*</i>	<i>B 53*</i> <i>B 54*</i>

* The pages indicated in italics refer to the Walter General catalogue 2012.

Product range overview of centre drills

Application		
Dimensions	DIN 333	
Designation	K1161	K1161XPL
Type	VHM	VHM-XPL
Form	A	A
Ø range	0,50 – 6,30	0,50 – 6,30
Page	B-84	B-85
Solid carbide centre drills		

Application				
Dimensions	DIN 333			
Designation	K1111TIN	K1111	K1112	K1131
Type	–	–	with flat	left-hand
Form	A	A	A	A
Ø range	1,00 – 5,00	0,50 – 12,50	1,60 – 5,00	0,50 – 6,30
Page	<i>B 292*</i>	<i>B 292*</i>	<i>B 293*</i>	<i>B 297*</i>
HSS centre drills				

Application							
Dimensions	DIN 333			DIN 333	Walter standard	Walter standard	
Designation	K1113TIN	K1113	K1114	K1215	K1313	K1311	K1411S
Type	–	–	with flat	–	–	–	–
Form	R	R	R	B	R	A	A
Ø range	1,00 – 5,00	0,50 – 12,50	1,60 – 5,00	1,00 – 10,00	1,00 – 4,00	0,63 – 6,00	0,75 – 5,00
Page	<i>B 295*</i>	<i>B 294*</i>	<i>B 296*</i>	<i>B 299*</i>	<i>B 301*</i>	<i>B 300*</i>	<i>B 304*</i>
HSS centre drills							

Application						
Dimensions	Walter standard		ANSI B 94.11 M-1979	B.S. 328	Step centre drill	
Designation	K1411M	K1411L	K1811	K1911	K2511	K2513
Type	–	–	–	–	60°	Radius
Form	A	A	A	A	–	R
Ø range	0,75 – 4,00	2,00 – 4,00	Nr.00 – Nr.8	B.S.1 – B.S.7	3,30 – 21,00	3,30 – 21,00
Page	<i>B 303*</i>	<i>B 302*</i>	<i>B 305*</i>	<i>B 306*</i>	<i>B 307*</i>	<i>B 308*</i>
HSS centre drills						

* The pages indicated in italics refer to the Walter General catalogue 2012.

Product range overview of reamers

Application				
Dimensions	Walter standard			
Designation	F2482	F2482TMS	F2481	F2481TMS
Type	Straight flute	Straight flute	Left-hand spiral	Left-hand spiral
Form	A	A	B	B
Ø range	3,97 – 20,00	3,97 – 20,00	3,97 – 20,00	3,97 – 20,00
Page	B-98	B-100	B-94	B-96
Solid carbide HSC reaming tools				

Application				
Dimensions	Walter standard			
Designation	F2162	F2171	F4162	F4171
Type	Straight flute	Left-hand spiral	Straight flute	Left-hand spiral
Form	A / C	B / D	A	B
Ø range	4,00 – 20,00	2,00 – 20,00	5,00 – 32,00	5,00 – 20,00
Page	B-92	B-93	<i>B 341*</i>	<i>B 342*</i>
Carbide reamers				

Application					
Dimensions	DIN 212			DIN 208	
Designation	F1342	F1352	F1352HUN	F4142	F4152
Type	Straight flute	Left-hand spiral	Left-hand spiral	Straight flute	Left-hand spiral
Form	A / C	B / D	B / D	A	B
Ø range	1,00 – 20,00	0,90 – 20,00	0,95 – 12,00	5,00 – 32,00	5,00 – 40,00
Page	<i>B 322*</i>	<i>B 325*</i>	<i>B 329*</i>	<i>B 337*</i>	<i>B 338*</i>
HSS reamers					

* The pages indicated in italics refer to the Walter General catalogue 2012.

Product range overview of reamers

Dimensions	DIN 219		DIN 2179	DIN 2180	DIN 311	DIN 206	DIN 859
Application							
Designation	F7133	Z2311	F3234	F6134	F4535	F1131	F1231
Type	Left-hand spiral	Adaptor:	Taper 1:50	Taper 1:50	Rivet hole	Hand reamer with left-hand spiral	Adjustable reamer with left-hand spiral
Form	B	–	–	–	–	B	B
Ø range	25,00 – 60,00	–	1,00 – 12,00	5,00 – 20,00	6,40 – 32,00	1,00 – 50,00	8,00 – 30,00
Page	<i>B 345*</i>	<i>G 66*</i>	<i>B 334*</i>	<i>B 344*</i>	<i>B 343*</i>	<i>B 317*</i>	<i>B 321*</i>
HSS reamers							

* The pages indicated in italics refer to the Walter General catalogue 2012.

Walter Select for carbide and HSS drilling and reaming tools

Step by step to the correct tool

STEP 1



Determine the **material** to be machined from page H 8 in the Walter General catalogue 2012.

Note the **machining group** that corresponds to your material e.g.: K5.

Code letter	Machining group	Groups of the materials to be machined	
P	P1–P15	Steel	All types of steel and cast steel, with the exception of steel with an austenitic structure
M	M1–M3	Stainless steel	Stainless austenitic steel and austenitic-ferritic steel and cast steel
K	K1–K7	Cast iron	Grey cast iron, cast iron with spheroidal graphite, malleable cast iron, cast iron with vermicular graphite
N	N1–N10	NF metals	Aluminium and other non-ferrous metals, non-ferrous materials
S	S1–S10	High temperature alloys and titanium alloys	Heat resisting special alloys based on iron, nickel and cobalt, titanium and titanium alloys
H	H1–H4	Hard materials	Hardened steel, hardened cast iron materials, chilled cast iron
O	O1–O6	Other	Plastics, glass and carbon fibre Reinforced plastics, graphite

STEP 2

Select the **machining conditions**:

Machine stability, clamping system and workpiece		
very good	good	moderate
		

STEP 3

Select the **cutting tool material** (HSS, carbide) and the **type of cooling**:

Tools made from **carbide with internal cooling**: Page B-10 onwards

Tools made from **carbide without internal cooling**: Page B-20 onwards

Tools made from **HSS**: Page B 26 onwards in the Walter General catalogue 2012.

STEP 4

Choose your tool:

- In acc. with the **drilling depth** or **DIN** (e.g. 3 x D_C or DIN 338)
- In acc. with the **machining conditions** (see step 2: 😊 😐 😞)
- For the relevant **machining group** (see step 1: P1–P15; M1–M3; . . . O1–O6)

Material group		Workpiece material		Brinell hardness HB		Tensile strength R _m N/mm ²		Machining group		Drilling depth	
										5 x D _C	
										Machining conditions	
										Designation: A3399XPL, A3399XPL Type: X-treme, Alpha [®] Jet Dimensions: DIN 6537 L, DIN 6537 L Ø range (mm): 3.00 – 25.00, 4.00 – 20.00 Cutting tool material: K30F, K20F Coating: XPL, uncoated Page: B-45 / B-62, B-85*	
P	Non-alloyed and low-alloyed steel	annealed (tempered)		210	700	P1, P2, P3, P4, P7	●●				
		machining steel		220	750	P6	●●				
		tempered		300	1010	P5, P8	●●				
		tempered		380	1280	P9	●●				
		tempered		430	1480	P10	●●				
	High-alloyed steel and high-alloyed tool steel	annealed		200	670	P11	●●				
		hardened and tempered		300	1010	P12	●●				
		hardened and tempered		400	1360	P13	●●				
	Stainless steel	ferritic/martensitic, annealed		200	670	P14	●●				
		martensitic, tempered		330	1110	P15	●●				
M	Stainless steel	austenitic, duplex		230	780		●●				
		austenitic, precipitation hardened (PH)					●●				

STEP 5

Choose your **cutting data** from the table from page B-102 onwards:

- **Cutting speed:**
v_C; VCRR (v_C rating chart for micro)
- **Feed:**
VRR (feed rating chart)

Go to the row of your machining group (e.g. K5) and the column of your selected drilling and boring tool. You will find the cutting speed v_C or the VCRR and VRR there.

The v_C rating chart (VCRR) and the feed rating chart (VRR) can be found from page B-122 onwards.

Material group		Workpiece material		Brinell hardness HB		Tensile strength R _m N/mm ²		Machining group		Drilling depth				
										3 x D _C				
										Designation				
										Designation: K3299XPL, K3899XPL Type: X-treme Step 90, X-treme Plus Dimensions: Walter standard, DIN 6537 K Ø range (mm): 3.30 – 14.00, 3.00 – 20.00 Cutting tool material: K30F, K30F Coating: XPL, DPL Page: B-75 / B-77, B-78*				
										Designation: A3289DPL Type: X-treme Plus Dimensions: DIN 6537 K Ø range (mm): 3.00 – 20.00 Cutting tool material: K30F Coating: DPL Page: B-78*				
P	Non-alloyed steel	C ≤ 0.25%	annealed	125	428	P1	140	12	EO	ML	200	16	EO	ML
		C > 0.25, ≤ 0.55%	annealed	190	639	P2	140	12	EO	ML	180	12	EO	ML
		C > 0.25, ≤ 0.55%	tempered	210	708	P3	130	12	EO	ML	170	12	EO	ML
		C > 0.55%	annealed	190	639	P4	140	12	EO	ML	180	12	EO	ML
		C > 0.55%	tempered	300	1013	P5	105	10	EO	ML	140	12	EO	ML
	Low-alloyed steel	machining steel (short-chipping)	annealed	220	745	P6	150	12	EO	ML	200	16	EO	ML
		annealed		175	591	P7	140	12	EO	ML	180	12	EO	ML
		tempered		300	1013	P8	105	10	EO	ML	140	12	EO	ML
	High-alloyed steel and high-alloyed tool steel	tempered		380	1282	P9	80	7	EO	ML	100	8	EO	ML
		tempered		430	1477	P10	63	5	EO	ML	80	6	EO	ML
Stainless steel	annealed		200	675	P11	71	9	EO	ML	85	9	EO	ML	
	hardened and tempered		300	1013	P12	95	9	EO	ML	120	10	EO	ML	
	hardened and tempered		400	1361	P13	63	5	EO	ML	80	6	EO	ML	
Stainless steel	ferritic/martensitic, annealed		200	675	P14	71	9	EO	ML	85	9	EO	ML	
	martensitic, tempered		330	1114	P15	40	8	EO	ML	50	9	EO	ML	
M	Stainless steel	austenitic, quench hardened		200	675	M1	40	6	EO	ML	50	6	EO	ML
		austenitic, precipitation hardened (PH)		300	1013	M2	45	6	EO	ML	63	6	EO	ML
		austenitic/ferritic, duplex		230	778	M3	34	5	EO	ML	40	6	EO	ML
	Malleable cast iron													

Walter Select – Drilling

Solid carbide drills with internal cooling

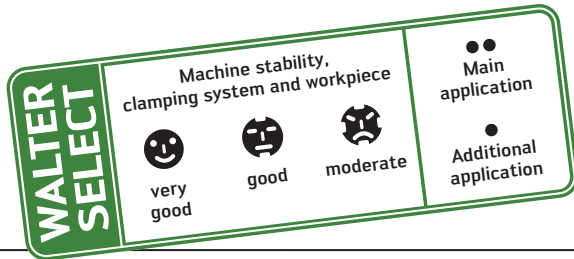

Drilling depth	3 x D _c
Machining conditions	☺
Designation	K3299XPL K3899XPL
Type	X-treme Step 90
Dimensions	Walter standard
Ø range (mm)	3,30 – 14,00
Cutting tool material	K30F
Coating	XPL
Page	B-75 / B-77

Material group	Grouping of main material groups and code letters		Brinell hardness HB	Tensile strength R _m N/mm ²	Machining group		
	Workpiece material						
P	Non-alloyed and low-alloyed steel	annealed (tempered)	210	700	P1, P2, P3, P4, P7	●●	
		machining steel	220	750	P6	●●	
		tempered	300	1010	P5, P8	●●	
		tempered	380	1280	P9	●●	
		tempered	430	1480	P10	●●	
	High-alloyed steel and high-alloyed tool steel	annealed	200	670	P11	●●	
		hardened and tempered	300	1010	P12	●●	
		hardened and tempered	400	1360	P13	●●	
	Stainless steel	ferritic/martensitic, annealed	200	670	P14	●●	
		martensitic, tempered	330	1110	P15	●●	
M	Stainless steel	austenitic, duplex	230	780	M1, M3	●●	
		austenitic, precipitation hardened (PH)	300	1010	M2	●●	
	Grey cast iron		245	–	K3, K4	●●	
K	Cast iron with spheroidal graphite	ferritic, pearlitic	365	–	K1, K2, K5, K6	●●	
	GGV (CGI)		200	–	K7	●●	
N	Aluminium wrought alloys	cannot be hardened	30	–	N1		
		hardenable, hardened	100	340	N2		
	Cast aluminium alloys	≤ 12% Si	90	310	N3, N4	●	
		> 12% Si	130	450	N5	●●	
	Magnesium alloys		70	250	N6		
Copper and copper alloys (bronze/brass)	non-alloyed, electrolytic copper		100	340	N7	●●	
	brass, bronze, red brass		90	310	N8	●●	
	Cu-alloys, short-chipping		110	380	N9	●●	
	high-strength, Ampco		300	1010	N10	●●	
S	Heat-resistant alloys	Fe-based	280	940	S1, S2	●●	
		Ni or Co base	250	840	S3	●●	
		Ni or Co base	350	1080	S4, S5	●●	
	Titanium alloys	pure titanium	200	670	S6	●●	
		α and β alloys, hardened	375	1260	S7	●●	
		β alloys	410	1400	S8	●●	
Tungsten alloys		300	1010	S9	●		
Molybdenum alloys		300	1010	S10	●		
H	Hardened steel		50 HRC	–	H1	●●	
			55 HRC	–	H2, H4	●	
			60 HRC	–	H3		
O	Thermoplasts	without abrasive fillers			O1		
	Thermosetting plastics	without abrasive fillers			O2		
	Plastic, fibre-reinforced	GFRP, AFRP				O3, O5	
		CFRP				O4	
Graphite (technical)			65		O6		

* The pages indicated in italics refer to the Walter General catalogue 2012.

Walter Select – Drilling

Solid carbide drills with internal cooling

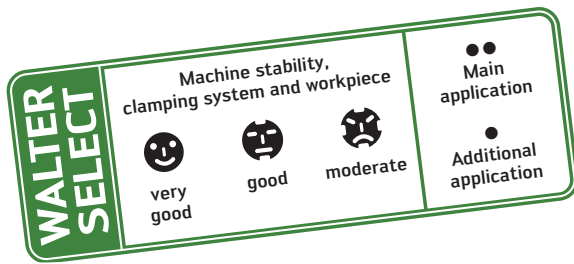

Drilling depth	5 x D _c	
Machining conditions		
Designation	A3399XPL A3999XPL	A3387
Type	X-treme	Alpha® Jet
Dimensions	DIN 6537 L	DIN 6537 L
Ø range (mm)	3,00 – 25,00	4,00 – 20,00
Cutting tool material	K30F	K20F
Coating	XPL	uncoated
Page	B-45 / B-62	B 85*

Material group	Grouping of main material groups and code letters		Brinell hardness HB	Tensile strength R _m N/mm ²	Machining group			
	Workpiece material							
P	Non-alloyed and low-alloyed steel	annealed (tempered)	210	700	P1, P2, P3, P4, P7	●●		
		machining steel	220	750	P6	●●		
		tempered	300	1010	P5, P8	●●		
		tempered	380	1280	P9	●●		
		tempered	430	1480	P10	●●		
	High-alloyed steel and high-alloyed tool steel	annealed	200	670	P11	●●		
hardened and tempered		300	1010	P12	●●			
hardened and tempered		400	1360	P13	●●			
Stainless steel	ferritic/martensitic, annealed	200	670	P14	●●			
	martensitic, tempered	330	1110	P15	●●			
M	Stainless steel	austenitic, duplex	230	780	M1, M3	●●		
		austenitic, precipitation hardened (PH)	300	1010	M2	●●		
K	Grey cast iron		245	–	K3, K4	●●	●●	
	Cast iron with spheroidal graphite	ferritic, pearlitic	365	–	K1, K2, K5, K6	●●	●●	
	GGV (CGI)		200	–	K7	●●		
N	Aluminium wrought alloys	cannot be hardened	30	–	N1		●	
		hardenable, hardened	100	340	N2		●	
	Cast aluminium alloys	≤ 12% Si	90	310	N3, N4	●	●●	
		> 12% Si	130	450	N5	●●	●●	
	Magnesium alloys		70	250	N6			
	Copper and copper alloys (bronze/brass)	non-alloyed, electrolytic copper		100	340	N7	●●	
brass, bronze, red brass			90	310	N8	●●		
Cu-alloys, short-chipping			110	380	N9	●●	●●	
high-strength, Ampco			300	1010	N10	●●		
S	Heat-resistant alloys	Fe-based	280	940	S1, S2	●●		
		Ni or Co base	250	840	S3	●●		
		Ni or Co base	350	1080	S4, S5	●●		
	Titanium alloys	pure titanium	200	670	S6	●●		
		α and β alloys, hardened	375	1260	S7	●●		
		β alloys	410	1400	S8	●●		
Tungsten alloys		300	1010	S9	●	●		
Molybdenum alloys		300	1010	S10	●	●		
H	Hardened steel		50 HRC	–	H1	●●		
			55 HRC	–	H2, H4	●		
			60 HRC	–	H3			
O	Thermoplasts	without abrasive fillers			O1		●●	
	Thermosetting plastics	without abrasive fillers			O2			
	Plastic, fibre-reinforced	GFRP, AFRP				O3, O5		
		CFRP				O4		
Graphite (technical)			65		O6			

* The pages indicated in italics refer to the Walter General catalogue 2012.

	5 x D _c	8 x D _c				
	☺	☺	☺	☺	☺	☺
	A3384	A6489AMP	A6488TML	A6489DPP	A3487	A3486TIP A3586TIP
	Alpha® Ni	X-treme DM8	Alpha® 4 Plus Micro	X-treme D8	Alpha® Jet	Alpha® 44
	DIN 6537 L	Walter standard	Walter standard	Walter standard	Walter standard	Walter standard
	3,00 – 12,00	2,00 – 2,95	0,75 – 1,95	3,00 – 20,00	5,00 – 20,00	5,00 – 12,00
	K20F	K30F	K30F	K30F	K20F	K30F
	uncoated	AMP	TML	DPP	uncoated	TIP
	<i>B 84*</i>	B-67	<i>B 121*</i>	<i>B 123*</i>	<i>B 95*</i>	<i>B 94* / B 96*</i>
		••	••	••		••
		••	••	••		••
		••	••	••		•
	•	••	••	••		
		••	••	••		••
		••	••	••		•
	•	••	••	••		••
		••	••	••		••
		••	••	••		•
	•	••	••	••		•
		••	••	••	••	•
		••	••	••	•	•
		••	••	••	•	••
		••	••	••	•	••
		••	••	••	••	••
		••	••	••	•	••
	••	••	••	••		•
	••	••	••	••		••
	••	••	••	••		••
	•	••	•	•	•	•
	•	••	•	•	•	•
	•	••	•	••		•
		••	•			
		••	••	•	••	••

Walter Select – Drilling

Solid carbide drills with internal cooling

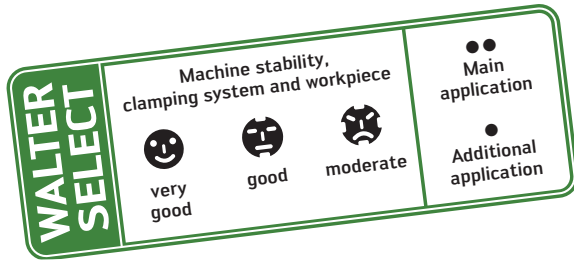

Drilling depth	12 x D _c	
Machining conditions		
Designation	A6589AMP	A6588TML
Type	X-treme DM12	Alpha® 4 Plus Micro
Dimensions	Walter standard	Walter standard
Ø range (mm)	2,00 – 2,90	1,00 – 1,90
Cutting tool material	K30F	K30F
Coating	AMP	TML
Page	B-68	<i>B 126*</i>

Material group	Grouping of main material groups and code letters		Brinell hardness HB	Tensile strength R _m N/mm ²	Machining group	12 x D _c	
	Workpiece material						
P	Non-alloyed and low-alloyed steel	annealed (tempered)	210	700	P1, P2, P3, P4, P7	●●	●●
		machining steel	220	750	P6	●●	●●
		tempered	300	1010	P5, P8	●●	●●
		tempered	380	1280	P9	●	●●
	High-alloyed steel and high-alloyed tool steel	tempered	430	1480	P10	●	●●
		annealed	200	670	P11	●●	●●
		hardened and tempered	300	1010	P12	●●	●●
Stainless steel	hardened and tempered	400	1360	P13	●	●●	
	ferritic/martensitic, annealed	200	670	P14	●●	●●	
	martensitic, tempered	330	1110	P15	●●	●●	
M	Stainless steel	austenitic, duplex	230	780	M1, M3	●●	●●
		austenitic, precipitation hardened (PH)	300	1010	M2	●●	●●
K	Grey cast iron		245	–	K3, K4	●●	●●
	Cast iron with spheroidal graphite	ferritic, pearlitic	365	–	K1, K2, K5, K6	●●	●●
	GGV (CGI)		200	–	K7	●●	●●
N	Aluminium wrought alloys	cannot be hardened	30	–	N1	●●	●●
		hardenable, hardened	100	340	N2	●●	●●
	Cast aluminium alloys	≤ 12% Si	90	310	N3, N4	●●	●●
		> 12% Si	130	450	N5	●●	●●
	Magnesium alloys		70	250	N6	●●	●●
	Copper and copper alloys (bronze/brass)	non-alloyed, electrolytic copper	100	340	N7	●●	●●
brass, bronze, red brass		90	310	N8	●●	●●	
Cu-alloys, short-chipping		110	380	N9	●●	●●	
high-strength, Ampco		300	1010	N10	●●	●●	
S	Heat-resistant alloys	Fe-based	280	940	S1, S2	●●	●●
		Ni or Co base	250	840	S3	●●	●●
		Ni or Co base	350	1080	S4, S5	●	●●
	Titanium alloys	pure titanium	200	670	S6	●●	●●
		α and β alloys, hardened	375	1260	S7	●●	●●
		β alloys	410	1400	S8	●●	●●
		Tungsten alloys	300	1010	S9	●●	●
Molybdenum alloys	300	1010	S10	●●	●		
H	Hardened steel		50 HRC	–	H1	●	●
			55 HRC	–	H2, H4	●	●
			60 HRC	–	H3		
O	Thermoplasts	without abrasive fillers			O1	●●	●●
	Thermosetting plastics	without abrasive fillers			O2		
	Plastic, fibre-reinforced	GFRP, AFRP			O3, O5		
		CFRP			O4		
	Graphite (technical)			65	O6		

* The pages indicated in italics refer to the Walter General catalogue 2012.

Walter Select – Drilling



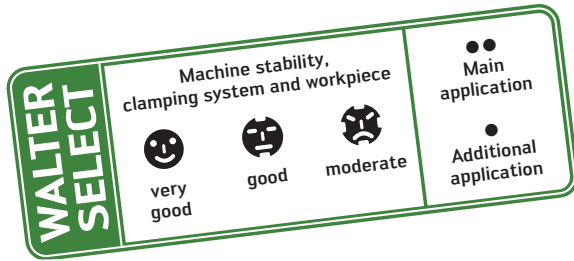





Solid carbide drills with internal cooling



Drilling depth	25 x D _c	
Machining conditions	☺	☹
Designation	A6889AMP	A6885TFP
Type	X-treme DM25	Alpha® 4 XD25
Dimensions	Walter standard	Walter standard
Ø range (mm)	2,00 – 2,90	3,00 – 12,00
Cutting tool material	K30F	K30F
Coating	AMP	TFP
Page	B-71	B 134*

Material group	Grouping of main material groups and code letters		Brinell hardness HB	Tensile strength R _m N/mm ²	Machining group			
	Workpiece material							
P	Non-alloyed and low-alloyed steel	annealed (tempered)	210	700	P1, P2, P3, P4, P7	●●	●●	
		machining steel	220	750	P6	●●	●●	
		tempered	300	1010	P5, P8	●●	●	
		tempered	380	1280	P9	●	●	
		tempered	430	1480	P10	●	●	
	High-alloyed steel and high-alloyed tool steel	annealed	200	670	P11	●●	●	
hardened and tempered		300	1010	P12	●●	●		
hardened and tempered		400	1360	P13	●	●		
Stainless steel	ferritic/martensitic, annealed	200	670	P14	●●	●		
	martensitic, tempered	330	1110	P15	●●	●		
M	Stainless steel	austenitic, duplex	230	780	M1, M3	●●	●●	
		austenitic, precipitation hardened (PH)	300	1010	M2	●●	●	
K	Grey cast iron		245	–	K3, K4	●●	●●	
	Cast iron with spheroidal graphite	ferritic, pearlitic	365	–	K1, K2, K5, K6	●●	●●	
	GGV (CGI)		200	–	K7	●●	●●	
N	Aluminium wrought alloys	cannot be hardened	30	–	N1	●●	●●	
		hardenable, hardened	100	340	N2	●●	●●	
	Cast aluminium alloys	≤ 12% Si	90	310	N3, N4	●●	●●	
		> 12% Si	130	450	N5	●●	●●	
	Magnesium alloys		70	250	N6			
	Copper and copper alloys (bronze/brass)	non-alloyed, electrolytic copper		100	340	N7	●●	●●
brass, bronze, red brass			90	310	N8	●●	●●	
Cu-alloys, short-chipping			110	380	N9	●●	●●	
high-strength, Ampco			300	1010	N10	●●	●●	
S	Heat-resistant alloys	Fe-based	280	940	S1, S2	●●	●	
		Ni or Co base	250	840	S3	●●	●●	
		Ni or Co base	350	1080	S4, S5	●	●	
	Titanium alloys	pure titanium	200	670	S6	●●	●●	
		α and β alloys, hardened	375	1260	S7	●●	●●	
		β alloys	410	1400	S8	●●	●●	
Tungsten alloys		300	1010	S9	●●	●		
Molybdenum alloys		300	1010	S10	●●	●		
H	Hardened steel		50 HRC	–	H1	●	●	
			55 HRC	–	H2, H4	●		
			60 HRC	–	H3			
O	Thermoplasts	without abrasive fillers			O1	●●	●●	
	Thermosetting plastics	without abrasive fillers			O2			
	Plastic, fibre-reinforced	GFRP, AFRP				O3, O5		
		CFRP				O4		
	Graphite (technical)			65		O6		

* The pages indicated in italics refer to the Walter General catalogue 2012.

	30 x D _c			40 x D _c
				
	A6989AMP	A6994TFP	A6985TFP	A7495TTP
	X-treme DM30	X-treme DH30	Alpha® 4 XD30	X-treme D40
	Walter standard	Walter standard	Walter standard	Walter standard
	2,00 – 2,90	3,00 – 10,00	3,00 – 12,00	4,50 – 11,00
	K30F	K30F	K30F	K30F
	AMP	TFP	TFP	TTP
	B-72	B 137*	B 136*	B-73
				
	••		••	••
	••		••	••
	••	••	•	•
	•	••		
	•	••	•	
	••	••	•	••
	••	••	•	•
	••	••	•	••
	••	••	•	•
	••		••	•
	••	••	•	
	••	•	••	••
	••		••	••
	••	••	••	••
	••		••	••
	••		••	••
	••		••	••
	••		••	••
	••		••	••
	••	••	••	••
	••	•	••	••
	••	••	•	•
	•		••	
	••		••	•
	••		••	
	••	•	•	
	••	•	•	
	•	•	•	
	•			
	••		••	

Walter Select – Drilling

Solid carbide drills with internal cooling

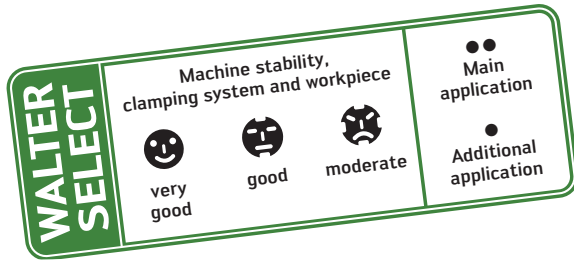

Drilling depth	Pilot drill	
Machining conditions		
Designation	K3281TFT	
Type	X-treme Pilot Step 90	
Dimensions	Walter standard	
Ø range (mm)	3,00 – 16,00	
Cutting tool material	K30F	
Coating	TFT	
Page	B-74	

Material group	Grouping of main material groups and code letters		Brinell hardness HB	Tensile strength R _m N/mm ²	Machining group		
	Workpiece material						
P	Non-alloyed and low-alloyed steel	annealed (tempered)	210	700	P1, P2, P3, P4, P7	●●	
		machining steel	220	750	P6	●●	
		tempered	300	1010	P5, P8	●●	
		tempered	380	1280	P9	●●	
		tempered	430	1480	P10	●●	
	High-alloyed steel and high-alloyed tool steel	annealed	200	670	P11	●●	
hardened and tempered		300	1010	P12	●●		
hardened and tempered		400	1360	P13	●●		
Stainless steel	ferritic/martensitic, annealed	200	670	P14	●●		
	martensitic, tempered	330	1110	P15	●●		
M	Stainless steel	austenitic, duplex	230	780	M1, M3	●●	
		austenitic, precipitation hardened (PH)	300	1010	M2	●●	
K	Grey cast iron		245	–	K3, K4	●●	
	Cast iron with spheroidal graphite	ferritic, pearlitic	365	–	K1, K2, K5, K6	●●	
	GGV (CGI)		200	–	K7	●●	
N	Aluminium wrought alloys	cannot be hardened	30	–	N1	●●	
		hardenable, hardened	100	340	N2	●●	
	Cast aluminium alloys	≤ 12% Si	90	310	N3, N4	●●	
		> 12% Si	130	450	N5	●●	
	Magnesium alloys		70	250	N6	●●	
	Copper and copper alloys (bronze/brass)	non-alloyed, electrolytic copper	100	340	N7	●●	
brass, bronze, red brass		90	310	N8	●●		
Cu-alloys, short-chipping		110	380	N9	●●		
high-strength, Ampco		300	1010	N10	●●		
S	Heat-resistant alloys	Fe-based	280	940	S1, S2	●●	
		Ni or Co base	250	840	S3	●●	
		Ni or Co base	350	1080	S4, S5	●●	
	Titanium alloys	pure titanium	200	670	S6	●●	
		α and β alloys, hardened	375	1260	S7	●●	
		β alloys	410	1400	S8	●●	
	Tungsten alloys		300	1010	S9	●	
Molybdenum alloys		300	1010	S10	●		
H	Hardened steel		50 HRC	–	H1	●●	
			55 HRC	–	H2, H4	●●	
			60 HRC	–	H3	●●	
O	Thermoplasts	without abrasive fillers			O1	●●	
	Thermosetting plastics	without abrasive fillers			O2	●●	
	Plastic, fibre-reinforced	GFRP, AFRP				O3, O5	●●
		CFRP				O4	●●
	Graphite (technical)			65		O6	●●

* The pages indicated in italics refer to the Walter General catalogue 2012.

Walter Select – Drilling

Solid carbide drills without internal cooling

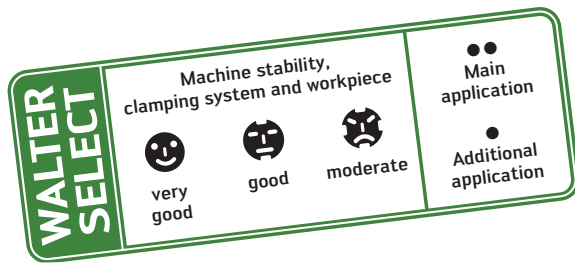

Drilling depth	3 x D _c	
Machining conditions		
Designation	K3879XPL	A3279XPL A3879XPL
Type	X-treme Step 90	X-treme
Dimensions	Walter standard	DIN 6537 K
Ø range (mm)	3,30 – 14,50	3,00 – 20,00
Cutting tool material	K30F	K30F
Coating	XPL	XPL
Page	B-76	B-26 / B-50

Material group	Grouping of main material groups and code letters		Brinell hardness HB	Tensile strength R _m N/mm ²	Machining group			
	Workpiece material							
P	Non-alloyed and low-alloyed steel	annealed (tempered)	210	700	P1, P2, P3, P4, P7	●●	●●	
		machining steel	220	750	P6	●●	●●	
		tempered	300	1010	P5, P8	●●	●●	
		tempered	380	1280	P9	●●	●●	
		tempered	430	1480	P10	●●	●●	
	High-alloyed steel and high-alloyed tool steel	annealed	200	670	P11	●●	●●	
hardened and tempered		300	1010	P12	●●	●●		
hardened and tempered		400	1360	P13	●●	●●		
Stainless steel	ferritic/martensitic, annealed	200	670	P14	●●	●●		
	martensitic, tempered	330	1110	P15	●●	●●		
M	Stainless steel	austenitic, duplex	230	780	M1, M3	●●	●●	
		austenitic, precipitation hardened (PH)	300	1010	M2	●●	●●	
K	Grey cast iron		245	–	K3, K4	●●	●●	
	Cast iron with spheroidal graphite	ferritic, pearlitic	365	–	K1, K2, K5, K6	●●	●●	
	GGV (CGI)		200	–	K7	●●	●●	
N	Aluminium wrought alloys	cannot be hardened	30	–	N1	●●	●●	
		hardenable, hardened	100	340	N2	●●	●●	
	Cast aluminium alloys	≤ 12% Si	90	310	N3, N4	●●	●●	
		> 12% Si	130	450	N5	●●	●●	
	Magnesium alloys		70	250	N6	●●	●●	
Copper and copper alloys (bronze/brass)	non-alloyed, electrolytic copper		100	340	N7	●●	●●	
	brass, bronze, red brass		90	310	N8	●●	●●	
	Cu-alloys, short-chipping		110	380	N9	●●	●●	
	high-strength, Ampco		300	1010	N10	●●	●●	
S	Heat-resistant alloys	Fe-based	280	940	S1, S2			
		Ni or Co base	250	840	S3			
		Ni or Co base	350	1080	S4, S5			
	Titanium alloys	pure titanium	200	670	S6	●●	●●	
		α and β alloys, hardened	375	1260	S7	●●	●●	
		β alloys	410	1400	S8	●●	●●	
Tungsten alloys		300	1010	S9	●	●		
Molybdenum alloys		300	1010	S10	●	●		
H	Hardened steel		50 HRC	–	H1	●●	●●	
			55 HRC	–	H2, H4			
			60 HRC	–	H3			
O	Thermoplasts	without abrasive fillers			O1	●●	●●	
	Thermosetting plastics	without abrasive fillers			O2			
	Plastic, fibre-reinforced	GFRP, AFRP				O3, O5		
		CFRP				O4		
	Graphite (technical)			65		O6		

* The pages indicated in italics refer to the Walter General catalogue 2012.

Walter Select – Drilling

Solid carbide drills without internal cooling

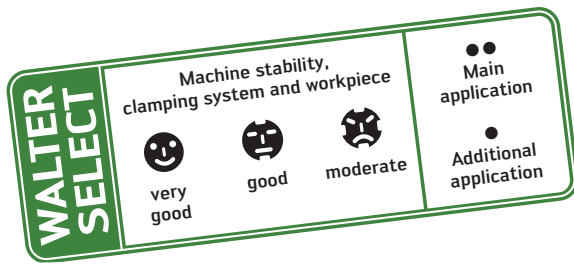

Drilling depth	5 x D _c
Machining conditions	
Designation	A3378TML
Type	Alpha® 2 Plus Micro
Dimensions	Walter standard
Ø range (mm)	0,50 – 2,95
Cutting tool material	K30F
Coating	TML
Page	B 79*

Material group	Grouping of main material groups and code letters		Brinell hardness HB	Tensile strength R _m N/mm ²	Machining group	
	Workpiece material					
P	Non-alloyed and low-alloyed steel	annealed (tempered)	210	700	P1, P2, P3, P4, P7	●●
		machining steel	220	750	P6	●●
		tempered	300	1010	P5, P8	●●
		tempered	380	1280	P9	●●
		tempered	430	1480	P10	●●
	High-alloyed steel and high-alloyed tool steel	annealed	200	670	P11	●●
hardened and tempered		300	1010	P12	●●	
hardened and tempered		400	1360	P13	●●	
Stainless steel	ferritic/martensitic, annealed	200	670	P14	●●	
	martensitic, tempered	330	1110	P15	●●	
M	Stainless steel	austenitic, duplex	230	780	M1, M3	●●
		austenitic, precipitation hardened (PH)	300	1010	M2	●●
K	Grey cast iron		245	–	K3, K4	●●
	Cast iron with spheroidal graphite	ferritic, pearlitic	365	–	K1, K2, K5, K6	●●
	GGV (CGI)		200	–	K7	●●
N	Aluminium wrought alloys	cannot be hardened	30	–	N1	●●
		hardenable, hardened	100	340	N2	●●
	Cast aluminium alloys	≤ 12% Si	90	310	N3, N4	●●
		> 12% Si	130	450	N5	●●
	Magnesium alloys		70	250	N6	●●
Copper and copper alloys (bronze/brass)	non-alloyed, electrolytic copper		100	340	N7	●●
	brass, bronze, red brass		90	310	N8	●●
	Cu-alloys, short-chipping		110	380	N9	●●
	high-strength, Ampco		300	1010	N10	●●
S	Heat-resistant alloys	Fe-based	280	940	S1, S2	●●
		Ni or Co base	250	840	S3	●●
		Ni or Co base	350	1080	S4, S5	●●
	Titanium alloys	pure titanium	200	670	S6	●●
		α and β alloys, hardened	375	1260	S7	●●
		β alloys	410	1400	S8	●●
Tungsten alloys		300	1010	S9	●●	
Molybdenum alloys		300	1010	S10	●●	
H	Hardened steel		50 HRC	–	H1	●
			55 HRC	–	H2, H4	●
			60 HRC	–	H3	●
O	Thermoplasts	without abrasive fillers			O1	●●
	Thermosetting plastics	without abrasive fillers			O2	●●
	Plastic, fibre-reinforced	GFRP, AFRP			O3, O5	●●
		CFRP			O4	●●
Graphite (technical)			65		O6	●●

* The pages indicated in italics refer to the Walter General catalogue 2012.

	5 x D _c			8 x D _c		
	A3162	A3379XPL A3979XPL	A3367 A3967	A6478TML	A1276TFL	A1263
	ESU	X-treme	BSX	Alpha® 2 Plus Micro	Alpha® 22	N
	DIN 1899	DIN 6537 L	DIN 6537 L	Walter standard	DIN 338	DIN 338
	0,10 – 1,45	3,00 – 25,00	3,00 – 16,00	0,50 – 2,95	3,00 – 12,00	0,60 – 12,00
	K30F	K30F	K30F	K30F	K30F	K30F
	uncoated	XPL	uncoated	TML	TFL	uncoated
	B 59*	B-37 / B-58	B 77* / B 110*	B 119*	B 57*	B 55*
	•	••		••	••	
	•	••		••	••	
	••	••		•		
	••	••		••		
	••	••		••	••	
	••	••		•		
	••	••		••	••	
	••	••		•		
	••	••		••	••	
	••	••		•		
	••	••	••	••	••	•
	••	••	••	••	••	•
	••	••	•	••	••	•
	••	••	••	••	••	•
	••	••	••	••	••	•
	••	••	••	••	••	••
	••	••	••	••	••	••
	••	••	••	••	••	••
	••	••	••	••	••	••
	••	••	•	••	••	••
	••	••	•	••	•	•
	••	••	•	••	•	•
	••	•	•	••	•	••
	••	•	•	••	•	••
		••		•		
	••	••	•	••		••
	••	••	••			••
	••	••	••			••
	••	••	••			••

Walter Select – Drilling

Solid carbide drills without internal cooling

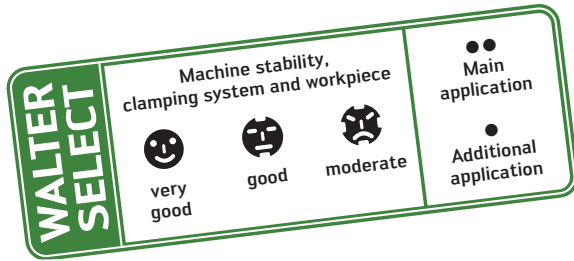

Drilling depth	3 x D _c – Carbide-tipped	
Machining conditions		
Designation	A2971	A5971
Type	HM	HM
Dimensions	DIN 8037	DIN 8041
Ø range (mm)	3,00 – 16,00	8,00 – 32,00
Cutting tool material	K10/20	K10/20
Coating	uncoated	uncoated
Page	<i>B 58*</i>	<i>B 116*</i>

Material group	Grouping of main material groups and code letters		Brinell hardness HB	Tensile strength R _m N/mm ²	Machining group		
	Workpiece material						
P	Non-alloyed and low-alloyed steel	annealed (tempered)	210	700	P1, P2, P3, P4, P7		
		machining steel	220	750	P6		
		tempered	300	1010	P5, P8		
		tempered	380	1280	P9		
		tempered	430	1480	P10	●	●
	High-alloyed steel and high-alloyed tool steel	annealed	200	670	P11		
hardened and tempered		300	1010	P12			
hardened and tempered		400	1360	P13	●	●	
Stainless steel	ferritic/martensitic, annealed	200	670	P14			
	martensitic, tempered	330	1110	P15			
M	Stainless steel	austenitic, duplex	230	780	M1, M3		
		austenitic, precipitation hardened (PH)	300	1010	M2		
K	Grey cast iron		245	–	K3, K4	●	●
	Cast iron with spheroidal graphite	ferritic, pearlitic	365	–	K1, K2, K5, K6	●	●
	GGV (CGI)		200	–	K7	●	●
N	Aluminium wrought alloys	cannot be hardened	30	–	N1		
		hardenable, hardened	100	340	N2		
	Cast aluminium alloys	≤ 12% Si	90	310	N3, N4		
		> 12% Si	130	450	N5		
	Magnesium alloys		70	250	N6		
	Copper and copper alloys (bronze/brass)	non-alloyed, electrolytic copper		100	340	N7	
brass, bronze, red brass			90	310	N8		
Cu-alloys, short-chipping			110	380	N9	●	●
high-strength, Ampco			300	1010	N10		
S	Heat-resistant alloys	Fe-based	280	940	S1, S2		
		Ni or Co base	250	840	S3		
		Ni or Co base	350	1080	S4, S5		
	Titanium alloys	pure titanium	200	670	S6		
		α and β alloys, hardened	375	1260	S7		
		β alloys	410	1400	S8		
Tungsten alloys		300	1010	S9			
Molybdenum alloys		300	1010	S10			
H	Hardened steel		50 HRC	–	H1	●	●
			55 HRC	–	H2, H4	●	●
			60 HRC	–	H3		
O	Thermoplasts	without abrasive fillers			O1		
	Thermosetting plastics	without abrasive fillers			O2	●	●
	Plastic, fibre-reinforced	GFRP, AFRP			O3, O5	●	●
		CFRP			O4	●	●
Graphite (technical)			65		O6	●	●

* The pages indicated in italics refer to the Walter General catalogue 2012.

Solid carbide twist drill

A3279XPL

X-treme



3 x D_c

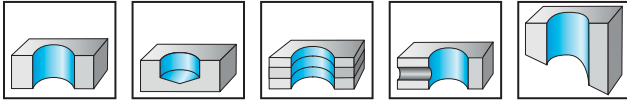

- K30F - XPL
- Type X-treme
- Right-hand cutting
- 140° point angle

Special features:

Suitable for dry machining in steel and cast iron
45 - 55 HRC

	P	M	K	N	S	H	O
XPL	●●	●●	●●	●●	●●	●●	●●

DIN 6537 short	D _c m7 mm	D _c Inches/No	d ₁ h6 mm	L _c mm	l ₁ mm	l ₂ mm	l ₅ mm	Designation A3279XPL
Shank DIN 6535 HA	3		6	14	62	20	36	★ -3
	3,1		6	14	62	20	36	★ -3.1
	3,175	1/8"	6	14	62	20	36	★ -1/8IN
	3,2		6	14	62	20	36	★ -3.2
	3,25		6	14	62	20	36	★ -3.25
	3,3		6	14	62	20	36	★ -3.3
	3,4		6	14	62	20	36	★ -3.4
	3,5		6	14	62	20	36	★ -3.5
	3,572	9/64"	6	14	62	20	36	★ -9/64IN
	3,6		6	14	62	20	36	★ -3.6
	3,65		6	14	62	20	36	★ -3.65
	3,7		6	14	62	20	36	★ -3.7
	3,8		6	17	66	24	36	★ -3.8
	3,9		6	17	66	24	36	★ -3.9
	3,969	5/32"	6	17	66	24	36	★ -5/32IN
	4		6	17	66	24	36	★ -4
	4,1		6	17	66	24	36	★ -4.1
	4,2		6	17	66	24	36	★ -4.2
	4,3		6	17	66	24	36	★ -4.3
	4,366	11/64"	6	17	66	24	36	★ -11/64IN
	4,4		6	17	66	24	36	★ -4.4
	4,5		6	17	66	24	36	★ -4.5
	4,6		6	17	66	24	36	★ -4.6
	4,65		6	17	66	24	36	★ -4.65
	4,7		6	17	66	24	36	★ -4.7
	4,763	3/16"	6	20	66	28	36	★ -3/16IN
	4,8		6	20	66	28	36	★ -4.8
	4,9		6	20	66	28	36	★ -4.9
	5		6	20	66	28	36	★ -5
	5,1		6	20	66	28	36	★ -5.1
	5,159	13/64"	6	20	66	28	36	★ -13/64IN
	5,2		6	20	66	28	36	★ -5.2
	5,3		6	20	66	28	36	★ -5.3
	5,4		6	20	66	28	36	★ -5.4
	5,5		6	20	66	28	36	★ -5.5
	5,55		6	20	66	28	36	★ -5.55
	5,556	7/32"	6	20	66	28	36	★ -7/32IN
	5,6		6	20	66	28	36	★ -5.6
	5,7		6	20	66	28	36	★ -5.7
	5,8		6	20	66	28	36	★ -5.8
	5,9		6	20	66	28	36	★ -5.9
	5,953	15/64"	6	20	66	28	36	★ -15/64IN
	6		6	20	66	28	36	★ -6
	6,1		8	24	79	34	36	★ -6.1
	6,2		8	24	79	34	36	★ -6.2
	6,3		8	24	79	34	36	★ -6.3
	6,35	1/4"	8	24	79	34	36	★ -1/4IN

Continued

★ New addition to range



Solid carbide twist drill

A3279XPL

X-treme



3 x D_c

	P	M	K	N	S	H	O
XPL	●	●	●	●	●	●	●

Continued

DIN 6537 short	D _c m7 mm	D _c Inches/No	d ₁ h6 mm	L _c mm	l ₁ mm	l ₂ mm	l ₅ mm	Designation A3279XPL
Shank DIN 6535 HA	6,4		8	24	79	34	36	★ -6.4
	6,5		8	24	79	34	36	★ -6.5
	6,6		8	24	79	34	36	★ -6.6
	6,7		8	24	79	34	36	★ -6.7
	6,747	17/64"	8	24	79	34	36	★ -17/64IN
	6,8		8	24	79	34	36	★ -6.8
	6,9		8	24	79	34	36	★ -6.9
	7		8	24	79	34	36	★ -7
	7,1		8	29	79	41	36	★ -7.1
	7,144	9/32"	8	29	79	41	36	★ -9/32IN
	7,2		8	29	79	41	36	★ -7.2
	7,3		8	29	79	41	36	★ -7.3
	7,4		8	29	79	41	36	★ -7.4
	7,5		8	29	79	41	36	★ -7.5
	7,541	19/64"	8	29	79	41	36	★ -19/64IN
	7,55		8	29	79	41	36	★ -7.55
	7,6		8	29	79	41	36	★ -7.6
	7,7		8	29	79	41	36	★ -7.7
	7,8		8	29	79	41	36	★ -7.8
	7,9		8	29	79	41	36	★ -7.9
	7,938	5/16"	8	29	79	41	36	★ -5/16IN
	8		8	29	79	41	36	★ -8
	8,1		10	35	89	47	40	★ -8.1
	8,2		10	35	89	47	40	★ -8.2
	8,3		10	35	89	47	40	★ -8.3
	8,334	21/64"	10	35	89	47	40	★ -21/64IN
	8,4		10	35	89	47	40	★ -8.4
	8,5		10	35	89	47	40	★ -8.5
	8,6		10	35	89	47	40	★ -8.6
	8,7		10	35	89	47	40	★ -8.7
	8,731	11/32"	10	35	89	47	40	★ -11/32IN
	8,8		10	35	89	47	40	★ -8.8
	8,9		10	35	89	47	40	★ -8.9
	9		10	35	89	47	40	★ -9
	9,1		10	35	89	47	40	★ -9.1
	9,128	23/64"	10	35	89	47	40	★ -23/64IN
	9,2		10	35	89	47	40	★ -9.2
	9,3		10	35	89	47	40	★ -9.3
	9,4		10	35	89	47	40	★ -9.4
	9,5		10	35	89	47	40	★ -9.5
	9,525	3/8"	10	35	89	47	40	★ -3/8IN
	9,55		10	35	89	47	40	★ -9.55
	9,6		10	35	89	47	40	★ -9.6
	9,7		10	35	89	47	40	★ -9.7
	9,8		10	35	89	47	40	★ -9.8
	9,9		10	35	89	47	40	★ -9.9
	9,922	25/64"	10	35	89	47	40	★ -25/64IN
	10		10	35	89	47	40	★ -10
	10,1		12	40	102	55	45	★ -10.1
	10,2		12	40	102	55	45	★ -10.2
	10,3		12	40	102	55	45	★ -10.3
	10,319	13/32"	12	40	102	55	45	★ -13/32IN
	10,4		12	40	102	55	45	★ -10.4
	10,5		12	40	102	55	45	★ -10.5
	10,6		12	40	102	55	45	★ -10.6

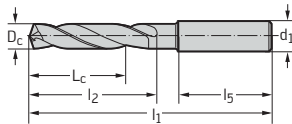

★ New addition to range

Continued

B-137

G-2

B-102

Solid carbide twist drill

A3279XPL

X-treme

 3 x D_c

Continued

	P	M	K	N	S	H	O
XPL	●●	●●	●●	●●	●●	●●	●●

DIN 6537 short	D _c m7 mm	D _c Inches/No	d ₁ h6 mm	L _c mm	l ₁ mm	l ₂ mm	l ₅ mm	Designation A3279XPL
Shank DIN 6535 HA	10,7		12	40	102	55	45	★ -10.7
	10,716	27/64"	12	40	102	55	45	★ -27/64IN
	10,8		12	40	102	55	45	★ -10.8
	10,9		12	40	102	55	45	★ -10.9
	11		12	40	102	55	45	★ -11
	11,1		12	40	102	55	45	★ -11.1
	11,113	7/16"	12	40	102	55	45	★ -7/16IN
	11,2		12	40	102	55	45	★ -11.2
	11,3		12	40	102	55	45	★ -11.3
	11,4		12	40	102	55	45	★ -11.4
	11,5		12	40	102	55	45	★ -11.5
	11,509	29/64"	12	40	102	55	45	★ -29/64IN
	11,55		12	40	102	55	45	★ -11.55
	11,6		12	40	102	55	45	★ -11.6
	11,7		12	40	102	55	45	★ -11.7
	11,8		12	40	102	55	45	★ -11.8
	11,9		12	40	102	55	45	★ -11.9
	11,906	15/32"	12	40	102	55	45	★ -15/32IN
	12		12	40	102	55	45	★ -12
	12,1		14	43	107	60	45	★ -12.1
	12,2		14	43	107	60	45	★ -12.2
	12,25		14	43	107	60	45	★ -12.25
	12,3		14	43	107	60	45	★ -12.3
	12,303	31/64"	14	43	107	60	45	★ -31/64IN
	12,4		14	43	107	60	45	★ -12.4
	12,5		14	43	107	60	45	★ -12.5
	12,6		14	43	107	60	45	★ -12.6
	12,7	1/2"	14	43	107	60	45	★ -1/2IN
	12,75		14	43	107	60	45	★ -12.75
	12,8		14	43	107	60	45	★ -12.8
	12,9		14	43	107	60	45	★ -12.9
	13		14	43	107	60	45	★ -13
	13,1		14	43	107	60	45	★ -13.1
	13,2		14	43	107	60	45	★ -13.2
	13,3		14	43	107	60	45	★ -13.3
	13,4		14	43	107	60	45	★ -13.4
	13,494	17/32"	14	43	107	60	45	★ -17/32IN
	13,5		14	43	107	60	45	★ -13.5
	13,6		14	43	107	60	45	★ -13.6
	13,7		14	43	107	60	45	★ -13.7
	13,8		14	43	107	60	45	★ -13.8
	13,9		14	43	107	60	45	★ -13.9
	14		14	43	107	60	45	★ -14
	14,1		16	45	115	65	48	★ -14.1
	14,2		16	45	115	65	48	★ -14.2
	14,288	9/16"	16	45	115	65	48	★ -9/16IN
	14,3		16	45	115	65	48	★ -14.3
	14,4		16	45	115	65	48	★ -14.4
	14,5		16	45	115	65	48	★ -14.5
	14,6		16	45	115	65	48	★ -14.6
	14,7		16	45	115	65	48	★ -14.7
	14,75		16	45	115	65	48	★ -14.75
	14,8		16	45	115	65	48	★ -14.8
	15		16	45	115	65	48	★ -15
	15,1		16	45	115	65	48	★ -15.1

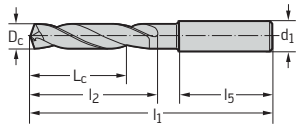

Continued

★ New addition to range



Solid carbide twist drill A3279XPL X-treme



3 x D_c

	P	M	K	N	S	H	O
XPL	●●	●●	●●	●●	●●	●●	●●

Continued

DIN 6537 short	D _c m7 mm	D _c Inches/No	d ₁ h6 mm	L _c mm	l ₁ mm	l ₂ mm	l ₅ mm	Designation A3279XPL
Shank DIN 6535 HA	15,2		16	45	115	65	48	★ -15.2
	15,3		16	45	115	65	48	★ -15.3
	15,5		16	45	115	65	48	★ -15.5
	15,6		16	45	115	65	48	★ -15.6
	15,7		16	45	115	65	48	★ -15.7
	15,8		16	45	115	65	48	★ -15.8
	15,875	5/8"	16	45	115	65	48	★ -5/8IN
	15,9		16	45	115	65	48	★ -15.9
	16		16	45	115	65	48	★ -16
	16,1		18	51	123	73	48	★ -16.1
	16,2		18	51	123	73	48	★ -16.2
	16,3		18	51	123	73	48	★ -16.3
	16,4		18	51	123	73	48	★ -16.4
	16,5		18	51	123	73	48	★ -16.5
	16,6		18	51	123	73	48	★ -16.6
	16,7		18	51	123	73	48	★ -16.7
	16,75		18	51	123	73	48	★ -16.75
	16,8		18	51	123	73	48	★ -16.8
	17		18	51	123	73	48	★ -17
	17,2		18	51	123	73	48	★ -17.2
	17,3		18	51	123	73	48	★ -17.3
	17,5		18	51	123	73	48	★ -17.5
	17,6		18	51	123	73	48	★ -17.6
	17,7		18	51	123	73	48	★ -17.7
	17,8		18	51	123	73	48	★ -17.8
	18		18	51	123	73	48	★ -18
	18,2		20	55	131	79	50	★ -18.2
	18,5		20	55	131	79	50	★ -18.5
	18,7		20	55	131	79	50	★ -18.7
	18,8		20	55	131	79	50	★ -18.8
	19		20	55	131	79	50	★ -19
	19,05	3/4"	20	55	131	79	50	★ -3/4IN
	19,5		20	55	131	79	50	★ -19.5
	19,7		20	55	131	79	50	★ -19.7
	19,8		20	55	131	79	50	★ -19.8
	20		20	55	131	79	50	★ -20

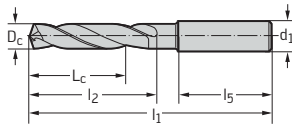

★ New addition to range



Solid carbide coolant through drills

A3293TTP

X-treme Innox



3 x D_c

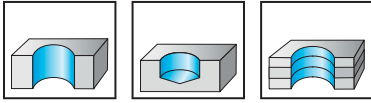

- K30F - TTP
- Type X-treme Innox
- Right-hand cutting
- 140° point angle

Special features:

Specially developed for machining stainless steels

	P	M	K	N	S	H	O
TTP	●●	●●	●	●	●●	●	●

DIN 6537 short	D _c m7 mm	D _c Inches/No	d ₁ h6 mm	L _c mm	l ₁ mm	l ₂ mm	l ₅ mm	Designation A3293TTP
Shank DIN 6535 HA	3		6	14	62	20	36	★ -3
	3,1		6	14	62	20	36	★ -3.1
	3,175	1/8"	6	14	62	20	36	★ -1/8IN
	3,2		6	14	62	20	36	★ -3.2
	3,25		6	14	62	20	36	★ -3.25
	3,3		6	14	62	20	36	★ -3.3
	3,4		6	14	62	20	36	★ -3.4
	3,5		6	14	62	20	36	★ -3.5
	3,6		6	14	62	20	36	★ -3.6
	3,7		6	14	62	20	36	★ -3.7
	3,8		6	17	66	24	36	★ -3.8
	3,9		6	17	66	24	36	★ -3.9
	3,969	5/32"	6	17	66	24	36	★ -5/32IN
	4		6	17	66	24	36	★ -4
	4,1		6	17	66	24	36	★ -4.1
	4,2		6	17	66	24	36	★ -4.2
	4,3		6	17	66	24	36	★ -4.3
	4,365	11/64"	6	17	66	24	36	★ -11/64IN
	4,4		6	17	66	24	36	★ -4.4
	4,5		6	17	66	24	36	★ -4.5
	4,6		6	17	66	24	36	★ -4.6
	4,65		6	17	66	24	36	★ -4.65
	4,7		6	17	66	24	36	★ -4.7
	4,763	3/16"	6	20	66	28	36	★ -3/16IN
	4,8		6	20	66	28	36	★ -4.8
	4,9		6	20	66	28	36	★ -4.9
	5		6	20	66	28	36	★ -5
	5,1		6	20	66	28	36	★ -5.1
	5,2		6	20	66	28	36	★ -5.2
	5,3		6	20	66	28	36	★ -5.3
	5,4		6	20	66	28	36	★ -5.4
	5,5		6	20	66	28	36	★ -5.5
	5,55		6	20	66	28	36	★ -5.55
	5,566		6	20	66	28	36	★ -7/32IN
	5,6		6	20	66	28	36	★ -5.6
	5,7		6	20	66	28	36	★ -5.7
	5,8		6	20	66	28	36	★ -5.8
	5,9		6	20	66	28	36	★ -5.9
	6		6	20	66	28	36	★ -6
	6,1		8	24	79	34	36	★ -6.1
	6,2		8	24	79	34	36	★ -6.2
	6,3		8	24	79	34	36	★ -6.3
	6,35	1/4"	8	24	79	34	36	★ -1/4IN
	6,4		8	24	79	34	36	★ -6.4
	6,5		8	24	79	34	36	★ -6.5
	6,6		8	24	79	34	36	★ -6.6
	6,7		8	24	79	34	36	★ -6.7

Continued

★ New addition to range

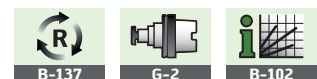



Solid carbide coolant through drills

A3293TTP

X-treme Inox

3 x D_c

	P	M	K	N	S	H	O
TTP	●	●	●	●	●	●	●

Continued

DIN 6537 short	D _c m7 mm	D _c Inches/No	d ₁ h6 mm	L _c mm	l ₁ mm	l ₂ mm	l ₅ mm	Designation A3293TTP
Shank DIN 6535 HA	6,8		8	24	79	34	36	★ -6.8
	6,9		8	24	79	34	36	★ -6.9
	7		8	24	79	34	36	★ -7
	7,1		8	29	79	41	36	★ -7.1
	7,144	9/32"	8	29	79	41	36	★ -9/32IN
	7,2		8	29	79	41	36	★ -7.2
	7,3		8	29	79	41	36	★ -7.3
	7,4		8	29	79	41	36	★ -7.4
	7,5		8	29	79	41	36	★ -7.5
	7,6		8	29	79	41	36	★ -7.6
	7,7		8	29	79	41	36	★ -7.7
	7,8		8	29	79	41	36	★ -7.8
	7,9		8	29	79	41	36	★ -7.9
	7,938	5/16"	8	29	79	41	36	★ -5/16IN
	8		8	29	79	41	36	★ -8
	8,1		10	35	89	47	40	★ -8.1
	8,2		10	35	89	47	40	★ -8.2
	8,3		10	35	89	47	40	★ -8.3
	8,4		10	35	89	47	40	★ -8.4
	8,5		10	35	89	47	40	★ -8.5
	8,6		10	35	89	47	40	★ -8.6
	8,7		10	35	89	47	40	★ -8.7
	8,731	11/32"	10	35	89	47	40	★ -11/32IN
	8,8		10	35	89	47	40	★ -8.8
	8,9		10	35	89	47	40	★ -8.9
	9		10	35	89	47	40	★ -9
	9,1		10	35	89	47	40	★ -9.1
	9,128	23/64"	10	35	89	47	40	★ -23/64IN
	9,2		10	35	89	47	40	★ -9.2
	9,3		10	35	89	47	40	★ -9.3
	9,4		10	35	89	47	40	★ -9.4
	9,5		10	35	89	47	40	★ -9.5
	9,525	3/8"	10	35	89	47	40	★ -3/8IN
	9,6		10	35	89	47	40	★ -9.6
	9,7		10	35	89	47	40	★ -9.7
	9,8		10	35	89	47	40	★ -9.8
	9,9		10	35	89	47	40	★ -9.9
	10		10	35	89	47	40	★ -10
	10,1		12	40	102	55	45	★ -10.1
	10,2		12	40	102	55	45	★ -10.2
	10,3		12	40	102	55	45	★ -10.3
	10,319	13/32"	12	40	102	55	45	★ -13/32IN
	10,4		12	40	102	55	45	★ -10.4
	10,5		12	40	102	55	45	★ -10.5
	10,6		12	40	102	55	45	★ -10.6
	10,7		12	40	102	55	45	★ -10.7
	10,8		12	40	102	55	45	★ -10.8
	10,9		12	40	102	55	45	★ -10.9
	11		12	40	102	55	45	★ -11
	11,1		12	40	102	55	45	★ -11.1
	11,113	7/16"	12	40	102	55	45	★ -7/16IN
	11,2		12	40	102	55	45	★ -11.2
	11,3		12	40	102	55	45	★ -11.3
	11,4		12	40	102	55	45	★ -11.4
	11,5		12	40	102	55	45	★ -11.5

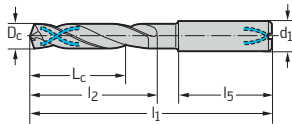

★ New addition to range

Continued

B-137

G-2

B-102

Solid carbide coolant through drills

A3293TTP

X-treme Inox

 3 x D_c

Continued

	P	M	K	N	S	H	O
TTP	●●	●●	●	●	●●	●	●

DIN 6537 short	D _c m7 mm	D _c Inches/No	d ₁ h6 mm	L _c mm	l ₁ mm	l ₂ mm	l ₅ mm	Designation A3293TTP
Shank DIN 6535 HA	11,6		12	40	102	55	45	★ -11.6
	11,7		12	40	102	55	45	★ -11.7
	11,8		12	40	102	55	45	★ -11.8
	11,9		12	40	102	55	45	★ -11.9
	11,906	15/32"	12	40	102	55	45	★ -15/32IN
	12		12	40	102	55	45	★ -12
	12,5		14	43	107	60	45	★ -12.5
	12,7	1/2"	14	43	107	60	45	★ -1/2IN
	12,9		14	43	107	60	45	★ -12.9
	13		14	43	107	60	45	★ -13
	13,1		14	43	107	60	45	★ -13.1
	13,3		14	43	107	60	45	★ -13.3
	13,5		14	43	107	60	45	★ -13.5
	13,8		14	43	107	60	45	★ -13.8
	14		14	43	107	60	45	★ -14
	14,2		16	45	115	65	48	★ -14.2
	14,288	9/16"	16	45	115	65	48	★ -9/16IN
	14,5		16	45	115	65	48	★ -14.5
	14,75		16	45	115	65	48	★ -14.75
	15		16	45	115	65	48	★ -15
	15,1		16	45	115	65	48	★ -15.1
	15,2		16	45	115	65	48	★ -15.2
	15,5		16	45	115	65	48	★ -15.5
	15,8		16	45	115	65	48	★ -15.8
	15,875	5/8"	16	45	115	65	48	★ -5/8IN
	16		16	45	115	65	48	★ -16
	16,5		18	51	123	73	48	★ -16.5
	16,8		18	51	123	73	48	★ -16.8
	17		18	51	123	73	48	★ -17
	17,5		18	51	123	73	48	★ -17.5
	17,8		18	51	123	73	48	★ -17.8
	18		18	51	123	73	48	★ -18
	18,5		20	55	131	79	50	★ -18.5
	18,8		20	55	131	79	50	★ -18.8
	19		20	55	131	79	50	★ -19
	19,05	3/4"	20	55	131	79	50	★ -3/4IN
	19,5		20	55	131	79	50	★ -19.5
	19,8		20	55	131	79	50	★ -19.8
	20		20	55	131	79	50	★ -20

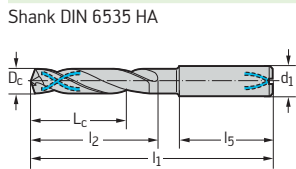

★ New addition to range



Solid carbide coolant through drills

A3299XPL

X-treme



3 x D_c

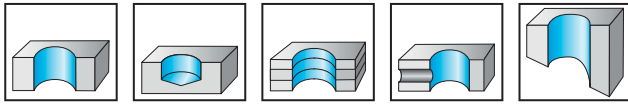

- K30F - XPL
- Type X-treme
- Right-hand cutting
- 140° point angle

Special features:

Suitable for dry machining in steel and cast iron
45 - 55 HRC

	P	M	K	N	S	H	O
XPL	●	●	●	●	●	●	●

DIN 6537 short	D _c m7 mm	D _c Inches/No	d ₁ h6 mm	L _c mm	l ₁ mm	l ₂ mm	l ₅ mm	Designation A3299XPL
Shank DIN 6535 HA	3		6	14	62	20	36	★ -3
	3,1		6	14	62	20	36	★ -3.1
	3,175	1/8"	6	14	62	20	36	★ -1/8IN
	3,2		6	14	62	20	36	★ -3.2
	3,25		6	14	62	20	36	★ -3.25
	3,3		6	14	62	20	36	★ -3.3
	3,4		6	14	62	20	36	★ -3.4
	3,5		6	14	62	20	36	★ -3.5
	3,572	9/64"	6	14	62	20	36	★ -9/64IN
	3,6		6	14	62	20	36	★ -3.6
	3,65		6	14	62	20	36	★ -3.65
	3,7		6	14	62	20	36	★ -3.7
	3,8		6	17	66	24	36	★ -3.8
	3,9		6	17	66	24	36	★ -3.9
	3,969	5/32"	6	17	66	24	36	★ -5/32IN
	4		6	17	66	24	36	★ -4
	4,1		6	17	66	24	36	★ -4.1
	4,2		6	17	66	24	36	★ -4.2
	4,3		6	17	66	24	36	★ -4.3
	4,366	11/64"	6	17	66	24	36	★ -11/64IN
	4,4		6	17	66	24	36	★ -4.4
	4,5		6	17	66	24	36	★ -4.5
	4,6		6	17	66	24	36	★ -4.6
	4,65		6	17	66	24	36	★ -4.65
	4,7		6	17	66	24	36	★ -4.7
	4,763	3/16"	6	20	66	28	36	★ -3/16IN
	4,8		6	20	66	28	36	★ -4.8
	4,9		6	20	66	28	36	★ -4.9
	5		6	20	66	28	36	★ -5
	5,1		6	20	66	28	36	★ -5.1
	5,159	13/64"	6	20	66	28	36	★ -13/64IN
	5,2		6	20	66	28	36	★ -5.2
	5,3		6	20	66	28	36	★ -5.3
	5,4		6	20	66	28	36	★ -5.4
	5,5		6	20	66	28	36	★ -5.5
	5,55		6	20	66	28	36	★ -5.55
	5,556	7/32"	6	20	66	28	36	★ -7/32IN
	5,6		6	20	66	28	36	★ -5.6
	5,7		6	20	66	28	36	★ -5.7
	5,8		6	20	66	28	36	★ -5.8
	5,9		6	20	66	28	36	★ -5.9
	5,953	15/64"	6	20	66	28	36	★ -15/64IN
	6		6	20	66	28	36	★ -6
	6,1		8	24	79	34	36	★ -6.1
	6,2		8	24	79	34	36	★ -6.2
	6,3		8	24	79	34	36	★ -6.3
	6,35	1/4"	8	24	79	34	36	★ -1/4IN

Continued

★ New addition to range



Solid carbide coolant through drills

A3299XPL

X-treme

 3 x D_c

Continued

	P	M	K	N	S	H	O
XPL	●	●	●	●	●	●	●

DIN 6537 short	D _c m7 mm	D _c Inches/No	d ₁ h6 mm	L _c mm	l ₁ mm	l ₂ mm	l ₅ mm	Designation A3299XPL
Shank DIN 6535 HA	6,4		8	24	79	34	36	★ -6.4
	6,5		8	24	79	34	36	★ -6.5
	6,6		8	24	79	34	36	★ -6.6
	6,7		8	24	79	34	36	★ -6.7
	6,747	17/64"	8	24	79	34	36	★ -17/64IN
	6,8		8	24	79	34	36	★ -6.8
	6,9		8	24	79	34	36	★ -6.9
	7		8	24	79	34	36	★ -7
	7,1		8	29	79	41	36	★ -7.1
	7,144	9/32"	8	29	79	41	36	★ -9/32IN
	7,2		8	29	79	41	36	★ -7.2
	7,3		8	29	79	41	36	★ -7.3
	7,4		8	29	79	41	36	★ -7.4
	7,5		8	29	79	41	36	★ -7.5
	7,541	19/64"	8	29	79	41	36	★ -19/64IN
	7,55		8	29	79	41	36	★ -7.55
	7,6		8	29	79	41	36	★ -7.6
	7,7		8	29	79	41	36	★ -7.7
	7,8		8	29	79	41	36	★ -7.8
	7,9		8	29	79	41	36	★ -7.9
	7,938	5/16"	8	29	79	41	36	★ -5/16IN
	8		8	29	79	41	36	★ -8
	8,1		10	35	89	47	40	★ -8.1
	8,2		10	35	89	47	40	★ -8.2
	8,3		10	35	89	47	40	★ -8.3
	8,334	21/64"	10	35	89	47	40	★ -21/64IN
	8,4		10	35	89	47	40	★ -8.4
	8,5		10	35	89	47	40	★ -8.5
	8,6		10	35	89	47	40	★ -8.6
	8,7		10	35	89	47	40	★ -8.7
	8,731	11/32"	10	35	89	47	40	★ -11/32IN
	8,8		10	35	89	47	40	★ -8.8
	8,9		10	35	89	47	40	★ -8.9
	9		10	35	89	47	40	★ -9
	9,1		10	35	89	47	40	★ -9.1
	9,128	23/64"	10	35	89	47	40	★ -23/64IN
	9,2		10	35	89	47	40	★ -9.2
	9,3		10	35	89	47	40	★ -9.3
	9,4		10	35	89	47	40	★ -9.4
	9,5		10	35	89	47	40	★ -9.5
	9,525	3/8"	10	35	89	47	40	★ -3/8IN
	9,55		10	35	89	47	40	★ -9.55
	9,6		10	35	89	47	40	★ -9.6
	9,7		10	35	89	47	40	★ -9.7
	9,8		10	35	89	47	40	★ -9.8
	9,9		10	35	89	47	40	★ -9.9
	9,922	25/64"	10	35	89	47	40	★ -25/64IN
	10		10	35	89	47	40	★ -10
	10,1		12	40	102	55	45	★ -10.1
	10,2		12	40	102	55	45	★ -10.2
	10,3		12	40	102	55	45	★ -10.3
	10,319	13/32"	12	40	102	55	45	★ -13/32IN
	10,4		12	40	102	55	45	★ -10.4
	10,5		12	40	102	55	45	★ -10.5
	10,6		12	40	102	55	45	★ -10.6

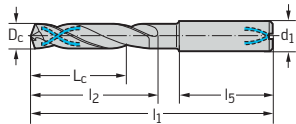

Continued

★ New addition to range



Solid carbide coolant through drills

A3299XPL

X-treme



3 x D_c

	P	M	K	N	S	H	O
XPL	●	●	●	●	●	●	●

Continued

DIN 6537 short	D _c m7 mm	D _c Inches/No	d ₁ h6 mm	L _c mm	l ₁ mm	l ₂ mm	l ₅ mm	Designation A3299XPL
Shank DIN 6535 HA	10,7		12	40	102	55	45	★ -10.7
	10,716	27/64"	12	40	102	55	45	★ -27/64IN
	10,8		12	40	102	55	45	★ -10.8
	10,9		12	40	102	55	45	★ -10.9
	11		12	40	102	55	45	★ -11
	11,1		12	40	102	55	45	★ -11.1
	11,113	7/16"	12	40	102	55	45	★ -7/16IN
	11,2		12	40	102	55	45	★ -11.2
	11,3		12	40	102	55	45	★ -11.3
	11,4		12	40	102	55	45	★ -11.4
	11,5		12	40	102	55	45	★ -11.5
	11,509	29/64"	12	40	102	55	45	★ -29/64IN
	11,55		12	40	102	55	45	★ -11.55
	11,6		12	40	102	55	45	★ -11.6
	11,7		12	40	102	55	45	★ -11.7
	11,8		12	40	102	55	45	★ -11.8
	11,9		12	40	102	55	45	★ -11.9
	11,906	15/32"	12	40	102	55	45	★ -15/32IN
	12		12	40	102	55	45	★ -12
	12,1		14	43	107	60	45	★ -12.1
	12,2		14	43	107	60	45	★ -12.2
	12,25		14	43	107	60	45	★ -12.25
	12,3		14	43	107	60	45	★ -12.3
	12,303	31/64"	14	43	107	60	45	★ -31/64IN
	12,4		14	43	107	60	45	★ -12.4
	12,5		14	43	107	60	45	★ -12.5
	12,6		14	43	107	60	45	★ -12.6
	12,7	1/2"	14	43	107	60	45	★ -1/2IN
	12,75		14	43	107	60	45	★ -12.75
	12,8		14	43	107	60	45	★ -12.8
	12,9		14	43	107	60	45	★ -12.9
	13		14	43	107	60	45	★ -13
	13,1		14	43	107	60	45	★ -13.1
	13,2		14	43	107	60	45	★ -13.2
	13,3		14	43	107	60	45	★ -13.3
	13,4		14	43	107	60	45	★ -13.4
	13,494	17/32"	14	43	107	60	45	★ -17/32IN
	13,5		14	43	107	60	45	★ -13.5
	13,6		14	43	107	60	45	★ -13.6
	13,7		14	43	107	60	45	★ -13.7
	13,8		14	43	107	60	45	★ -13.8
	13,9		14	43	107	60	45	★ -13.9
	14		14	43	107	60	45	★ -14
	14,1		16	45	115	65	48	★ -14.1
	14,2		16	45	115	65	48	★ -14.2
	14,288	9/16"	16	45	115	65	48	★ -9/16IN
	14,3		16	45	115	65	48	★ -14.3
	14,4		16	45	115	65	48	★ -14.4
	14,5		16	45	115	65	48	★ -14.5
	14,6		16	45	115	65	48	★ -14.6
	14,7		16	45	115	65	48	★ -14.7
	14,75		16	45	115	65	48	★ -14.75
	14,8		16	45	115	65	48	★ -14.8
	15		16	45	115	65	48	★ -15
	15,1		16	45	115	65	48	★ -15.1

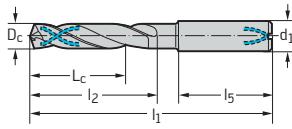

★ New addition to range

Continued

B-137

G-2

B-102

Solid carbide coolant through drills

A3299XPL

X-treme

 3 x D_c

Continued

	P	M	K	N	S	H	0
XPL	●●	●●	●●	●●	●●	●●	●●

DIN 6537 short	D _c m7 mm	D _c Inches/No	d ₁ h6 mm	L _c mm	l ₁ mm	l ₂ mm	l ₅ mm	Designation A3299XPL
Shank DIN 6535 HA	15,2		16	45	115	65	48	★ -15.2
	15,3		16	45	115	65	48	★ -15.3
	15,5		16	45	115	65	48	★ -15.5
	15,6		16	45	115	65	48	★ -15.6
	15,7		16	45	115	65	48	★ -15.7
	15,8		16	45	115	65	48	★ -15.8
	15,875	5/8"	16	45	115	65	48	★ -5/8IN
	15,9		16	45	115	65	48	★ -15.9
	16		16	45	115	65	48	★ -16
	16,1		18	51	123	73	48	★ -16.1
	16,2		18	51	123	73	48	★ -16.2
	16,3		18	51	123	73	48	★ -16.3
	16,4		18	51	123	73	48	★ -16.4
	16,5		18	51	123	73	48	★ -16.5
	16,6		18	51	123	73	48	★ -16.6
	16,7		18	51	123	73	48	★ -16.7
	16,75		18	51	123	73	48	★ -16.75
	16,8		18	51	123	73	48	★ -16.8
	17		18	51	123	73	48	★ -17
	17,2		18	51	123	73	48	★ -17.2
	17,3		18	51	123	73	48	★ -17.3
	17,5		18	51	123	73	48	★ -17.5
	17,6		18	51	123	73	48	★ -17.6
	17,7		18	51	123	73	48	★ -17.7
	17,8		18	51	123	73	48	★ -17.8
	18		18	51	123	73	48	★ -18
	18,2		20	55	131	79	50	★ -18.2
	18,5		20	55	131	79	50	★ -18.5
	18,7		20	55	131	79	50	★ -18.7
	18,8		20	55	131	79	50	★ -18.8
	19		20	55	131	79	50	★ -19
	19,05	3/4"	20	55	131	79	50	★ -3/4IN
	19,5		20	55	131	79	50	★ -19.5
	19,7		20	55	131	79	50	★ -19.7
	19,8		20	55	131	79	50	★ -19.8
	20		20	55	131	79	50	★ -20

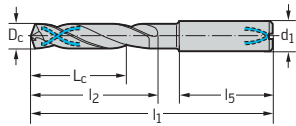

★ New addition to range



Solid carbide twist drill

A3379XPL

X-treme



5 x D_c

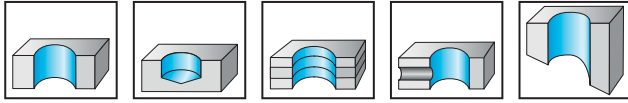

- K30F - XPL
- Type X-treme
- Right-hand cutting
- 140° point angle

Special features:

Suitable for dry machining in steel and cast iron
45 - 55 HRC

	P	M	K	N	S	H	O
XPL	●	●	●	●	●	●	●

DIN 6537 long	D _c m7 mm	D _c Inches/No	d ₁ h6 mm	L _c mm	l ₁ mm	l ₂ mm	l ₅ mm	Designation A3379XPL
Shank DIN 6535 HA	3		6	23	66	28	36	★ -3
	3,1		6	23	66	28	36	★ -3.1
	3,175	1/8"	6	23	66	28	36	★ -1/8IN
	3,2		6	23	66	28	36	★ -3.2
	3,25		6	23	66	28	36	★ -3.25
	3,3		6	23	66	28	36	★ -3.3
	3,4		6	23	66	28	36	★ -3.4
	3,5		6	23	66	28	36	★ -3.5
	3,572	9/64"	6	23	66	28	36	★ -9/64IN
	3,6		6	23	66	28	36	★ -3.6
	3,65		6	23	66	28	36	★ -3.65
	3,7		6	23	66	28	36	★ -3.7
	3,8		6	29	74	36	36	★ -3.8
	3,9		6	29	74	36	36	★ -3.9
	3,969	5/32"	6	29	74	36	36	★ -5/32IN
	4		6	29	74	36	36	★ -4
	4,1		6	29	74	36	36	★ -4.1
	4,2		6	29	74	36	36	★ -4.2
	4,3		6	29	74	36	36	★ -4.3
	4,366	11/64"	6	29	74	36	36	★ -11/64IN
	4,4		6	29	74	36	36	★ -4.4
	4,5		6	29	74	36	36	★ -4.5
	4,6		6	29	74	36	36	★ -4.6
	4,65		6	29	74	36	36	★ -4.65
	4,7		6	29	74	36	36	★ -4.7
	4,763	3/16"	6	35	82	44	36	★ -3/16IN
	4,8		6	35	82	44	36	★ -4.8
	4,9		6	35	82	44	36	★ -4.9
	5		6	35	82	44	36	★ -5
	5,1		6	35	82	44	36	★ -5.1
	5,159	13/64"	6	35	82	44	36	★ -13/64IN
	5,2		6	35	82	44	36	★ -5.2
	5,3		6	35	82	44	36	★ -5.3
	5,4		6	35	82	44	36	★ -5.4
	5,5		6	35	82	44	36	★ -5.5
	5,55		6	35	82	44	36	★ -5.55
	5,556	7/32"	6	35	82	44	36	★ -7/32IN
	5,6		6	35	82	44	36	★ -5.6
	5,7		6	35	82	44	36	★ -5.7
	5,8		6	35	82	44	36	★ -5.8
	5,9		6	35	82	44	36	★ -5.9
	5,953	15/64"	6	35	82	44	36	★ -15/64IN
	6		6	35	82	44	36	★ -6
	6,1		8	43	91	53	36	★ -6.1
	6,2		8	43	91	53	36	★ -6.2
	6,3		8	43	91	53	36	★ -6.3
	6,35	1/4"	8	43	91	53	36	★ -1/4IN

Continued

★ New addition to range



Solid carbide twist drill

A3379XPL

X-treme

 5 x D_c

Continued

	P	M	K	N	S	H	O
XPL	●●	●●	●●	●●	●●	●●	●●

DIN 6537 long	D _c m7 mm	D _c Inches/No	d ₁ h6 mm	L _c mm	l ₁ mm	l ₂ mm	l ₅ mm	Designation A3379XPL
Shank DIN 6535 HA	6,4		8	43	91	53	36	★ -6.4
	6,5		8	43	91	53	36	★ -6.5
	6,6		8	43	91	53	36	★ -6.6
	6,7		8	43	91	53	36	★ -6.7
	6,747	17/64"	8	43	91	53	36	★ -17/64IN
	6,8		8	43	91	53	36	★ -6.8
	6,9		8	43	91	53	36	★ -6.9
	7		8	43	91	53	36	★ -7
	7,1		8	43	91	53	36	★ -7.1
	7,144	9/32"	8	43	91	53	36	★ -9/32IN
	7,2		8	43	91	53	36	★ -7.2
	7,3		8	43	91	53	36	★ -7.3
	7,4		8	43	91	53	36	★ -7.4
	7,5		8	43	91	53	36	★ -7.5
	7,541	19/64"	8	43	91	53	36	★ -19/64IN
	7,55		8	43	91	53	36	★ -7.55
	7,6		8	43	91	53	36	★ -7.6
	7,7		8	43	91	53	36	★ -7.7
	7,8		8	43	91	53	36	★ -7.8
	7,9		8	43	91	53	36	★ -7.9
	7,938	5/16"	8	43	91	53	36	★ -5/16IN
	8		8	43	91	53	36	★ -8
	8,1		10	49	103	61	40	★ -8.1
	8,2		10	49	103	61	40	★ -8.2
	8,3		10	49	103	61	40	★ -8.3
	8,334	21/64"	10	49	103	61	40	★ -21/64IN
	8,4		10	49	103	61	40	★ -8.4
	8,5		10	49	103	61	40	★ -8.5
	8,6		10	49	103	61	40	★ -8.6
	8,7		10	49	103	61	40	★ -8.7
	8,731	11/32"	10	49	103	61	40	★ -11/32IN
	8,8		10	49	103	61	40	★ -8.8
	8,9		10	49	103	61	40	★ -8.9
	9		10	49	103	61	40	★ -9
	9,1		10	49	103	61	40	★ -9.1
	9,128	23/64"	10	49	103	61	40	★ -23/64IN
	9,2		10	49	103	61	40	★ -9.2
	9,3		10	49	103	61	40	★ -9.3
	9,4		10	49	103	61	40	★ -9.4
	9,5		10	49	103	61	40	★ -9.5
	9,525	3/8"	10	49	103	61	40	★ -3/8IN
	9,55		10	49	103	61	40	★ -9.55
	9,6		10	49	103	61	40	★ -9.6
	9,7		10	49	103	61	40	★ -9.7
	9,8		10	49	103	61	40	★ -9.8
	9,9		10	49	103	61	40	★ -9.9
	9,922	25/64"	10	49	103	61	40	★ -25/64IN
	10		10	49	103	61	40	★ -10
	10,1		12	56	118	71	45	★ -10.1
	10,2		12	56	118	71	45	★ -10.2
	10,3		12	56	118	71	45	★ -10.3
	10,319	13/32"	12	56	118	71	45	★ -13/32IN
	10,4		12	56	118	71	45	★ -10.4
	10,5		12	56	118	71	45	★ -10.5
	10,6		12	56	118	71	45	★ -10.6

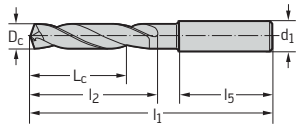

Continued

★ New addition to range



Solid carbide twist drill

A3379XPL

X-treme



5 x D_c

	P	M	K	N	S	H	O
XPL	●●	●●	●●	●●	●●	●●	●●

Continued

DIN 6537 long	D _c m7 mm	D _c Inches/No	d ₁ h6 mm	L _c mm	l ₁ mm	l ₂ mm	l ₅ mm	Designation A3379XPL
Shank DIN 6535 HA	10,7		12	56	118	71	45	★ -10.7
	10,716	27/64"	12	56	118	71	45	★ -27/64IN
	10,8		12	56	118	71	45	★ -10.8
	10,9		12	56	118	71	45	★ -10.9
	11		12	56	118	71	45	★ -11
	11,1		12	56	118	71	45	★ -11.1
	11,113	7/16"	12	56	118	71	45	★ -7/16IN
	11,2		12	56	118	71	45	★ -11.2
	11,3		12	56	118	71	45	★ -11.3
	11,4		12	56	118	71	45	★ -11.4
	11,5		12	56	118	71	45	★ -11.5
	11,509	29/64"	12	56	118	71	45	★ -29/64IN
	11,55		12	56	118	71	45	★ -11.55
	11,6		12	56	118	71	45	★ -11.6
	11,7		12	56	118	71	45	★ -11.7
	11,8		12	56	118	71	45	★ -11.8
	11,9		12	56	118	71	45	★ -11.9
	11,906	15/32"	12	56	118	71	45	★ -15/32IN
	12		12	56	118	71	45	★ -12
	12,1		14	60	124	77	45	★ -12.1
	12,2		14	60	124	77	45	★ -12.2
	12,25		14	60	124	77	45	★ -12.25
	12,3		14	60	124	77	45	★ -12.3
	12,303	31/64"	14	60	124	77	45	★ -31/64IN
	12,4		14	60	124	77	45	★ -12.4
	12,5		14	60	124	77	45	★ -12.5
	12,6		14	60	124	77	45	★ -12.6
	12,7	1/2"	14	60	124	77	45	★ -1/2IN
	12,75		14	60	124	77	45	★ -12.75
	12,8		14	60	124	77	45	★ -12.8
	12,9		14	60	124	77	45	★ -12.9
	13		14	60	124	77	45	★ -13
	13,1		14	60	124	77	45	★ -13.1
	13,2		14	60	124	77	45	★ -13.2
	13,3		14	60	124	77	45	★ -13.3
	13,4		14	60	124	77	45	★ -13.4
	13,494	17/32"	14	60	124	77	45	★ -17/32IN
	13,5		14	60	124	77	45	★ -13.5
	13,6		14	60	124	77	45	★ -13.6
	13,7		14	60	124	77	45	★ -13.7
	13,8		14	60	124	77	45	★ -13.8
	13,9		14	60	124	77	45	★ -13.9
	14		14	60	124	77	45	★ -14
	14,1		16	63	133	83	48	★ -14.1
	14,2		16	63	133	83	48	★ -14.2
	14,288	9/16"	16	63	133	83	48	★ -9/16IN
	14,3		16	63	133	83	48	★ -14.3
	14,4		16	63	133	83	48	★ -14.4
	14,5		16	63	133	83	48	★ -14.5
	14,6		16	63	133	83	48	★ -14.6
	14,7		16	63	133	83	48	★ -14.7
	14,75		16	63	133	83	48	★ -14.75
	14,8		16	63	133	83	48	★ -14.8
	15		16	63	133	83	48	★ -15
	15,1		16	63	133	83	48	★ -15.1

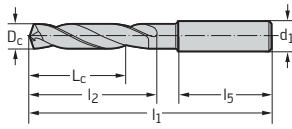

★ New addition to range

Continued

B-137

G-2

B-102

Solid carbide twist drill

A3379XPL

X-treme

 5 x D_c

Continued

	P	M	K	N	S	H	O
XPL	●●	●●	●●	●●	●●	●●	●●

DIN 6537 long	D _c m7 mm	D _c Inches/No	d ₁ h6 mm	L _c mm	l ₁ mm	l ₂ mm	l ₅ mm	Designation A3379XPL
Shank DIN 6535 HA	15,2		16	63	133	83	48	★ -15.2
	15,3		16	63	133	83	48	★ -15.3
	15,5		16	63	133	83	48	★ -15.5
	15,6		16	63	133	83	48	★ -15.6
	15,7		16	63	133	83	48	★ -15.7
	15,8		16	63	133	83	48	★ -15.8
	15,875	5/8"	16	63	133	83	48	★ -5/8IN
	15,9		16	63	133	83	48	★ -15.9
	16		16	63	133	83	48	★ -16
	16,1		18	71	143	93	48	★ -16.1
	16,2		18	71	143	93	48	★ -16.2
	16,3		18	71	143	93	48	★ -16.3
	16,4		18	71	143	93	48	★ -16.4
	16,5		18	71	143	93	48	★ -16.5
	16,6		18	71	143	93	48	★ -16.6
	16,7		18	71	143	93	48	★ -16.7
	16,75		18	71	143	93	48	★ -16.75
	16,8		18	71	143	93	48	★ -16.8
	17		18	71	143	93	48	★ -17
	17,2		18	71	143	93	48	★ -17.2
	17,3		18	71	143	93	48	★ -17.3
	17,5		18	71	143	93	48	★ -17.5
	17,6		18	71	143	93	48	★ -17.6
	17,7		18	71	143	93	48	★ -17.7
	17,8		18	71	143	93	48	★ -17.8
	18		18	71	143	93	48	★ -18
	18,2		20	77	153	101	50	★ -18.2
	18,5		20	77	153	101	50	★ -18.5
	18,7		20	77	153	101	50	★ -18.7
	18,8		20	77	153	101	50	★ -18.8
	19		20	77	153	101	50	★ -19
	19,05	3/4"	20	77	153	101	50	★ -3/4IN
	19,5		20	77	153	101	50	★ -19.5
	19,7		20	77	153	101	50	★ -19.7
	19,8		20	77	153	101	50	★ -19.8
	20		20	77	153	101	50	★ -20
	20,5		25	86	166	108	56	★ -20.5
	21		25	86	166	108	56	★ -21
	21,5		25	86	166	108	56	★ -21.5
	22		25	86	166	108	56	★ -22
	22,5		25	91	173	115	56	★ -22.5
	23		25	91	173	115	56	★ -23
	23,5		25	91	173	115	56	★ -23.5
	24		25	91	173	115	56	★ -24
	24,5		25	97	180	122	56	★ -24.5
	25		25	97	180	122	56	★ -25

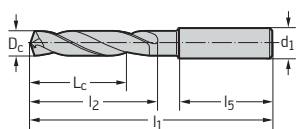

★ New addition to range



Solid carbide coolant through drill Micro A3389AML X-treme M



5 x D_c

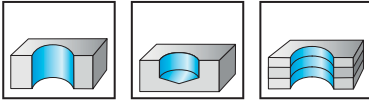

- K30F - AML
- Type X-treme M
- Right-hand cutting
- 140° point angle

	P	M	K	N	S	H	O
AML	●●	●●	●●	●●	●●	●	●●

	D _c m7 mm	D _c Inches/No	d ₁ h6 mm	L _c mm	l ₁ mm	l ₂ mm	l ₅ mm	Designation A3389AML
Shank DIN 6535 HA	2		3	14	57	17	35	★ -2
	2,05		3	14	57	18	35	★ -2.05
	2,1		3	14	57	18	35	★ -2.1
	2,15		3	15	57	19	34	★ -2.15
	2,2		3	15	57	19	34	★ -2.2
	2,25		3	16	59	20	35	★ -2.25
	2,3		3	16	59	20	35	★ -2.3
	2,35		3	16	59	20	35	★ -2.35
	2,381	3/32"	3	16	59	20	35	★ -3/32IN
	2,4		3	16	59	20	35	★ -2.4
	2,45		3	17	59	21	34	★ -2.45
	2,5		3	17	59	21	34	★ -2.5
	2,55		3	18	62	22	36	★ -2.55
	2,6		3	18	62	22	36	★ -2.6
	2,65		3	18	62	23	36	★ -2.65
	2,7		3	18	62	23	36	★ -2.7
	2,75		3	19	62	24	35	★ -2.75
	2,778	7/64"	3	19	62	24	35	★ -7/64IN
	2,8		3	19	62	24	35	★ -2.8
	2,85		3	20	62	25	34	★ -2.85
	2,9		3	20	62	25	34	★ -2.9
	2,95		3	20	62	25	34	★ -2.95

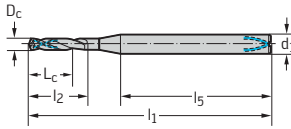

★ New addition to range



Solid carbide coolant through drills

A3393TTP

X-treme Inox



5 x D_c

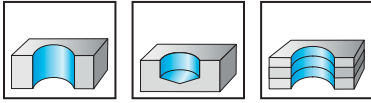

- K30F - TTP
- Type X-treme Inox
- Right-hand cutting
- 140° point angle

Special features:
Specially for machining stainless steels

	P	M	K	N	S	H	O
TTP	●●	●●	●	●	●●	●	●

DIN 6537 long	D _c m7 mm	D _c Inches/No	d ₁ h6 mm	L _c mm	l ₁ mm	l ₂ mm	l ₅ mm	Designation A3393TTP
Shank DIN 6535 HA	3		6	23	66	28	36	★ -3
	3,1		6	23	66	28	36	★ -3.1
	3,175	1/8"	6	23	66	28	36	★ -1/8IN
	3,2		6	23	66	28	36	★ -3.2
	3,25		6	23	66	28	36	★ -3.25
	3,3		6	23	66	28	36	★ -3.3
	3,4		6	23	66	28	36	★ -3.4
	3,5		6	23	66	28	36	★ -3.5
	3,6		6	23	66	28	36	★ -3.6
	3,7		6	23	66	28	36	★ -3.7
	3,8		6	29	74	36	36	★ -3.8
	3,9		6	29	74	36	36	★ -3.9
	3,969	5/32"	6	29	74	36	36	★ -5/32IN
	4		6	29	74	36	36	★ -4
	4,1		6	29	74	36	36	★ -4.1
	4,2		6	29	74	36	36	★ -4.2
	4,3		6	29	74	36	36	★ -4.3
	4,365	11/64"	6	23	74	36	36	★ -11/64IN
	4,4		6	29	74	36	36	★ -4.4
	4,5		6	29	74	36	36	★ -4.5
	4,6		6	29	74	36	36	★ -4.6
	4,65		6	29	74	36	36	★ -4.65
	4,7		6	29	74	36	36	★ -4.7
	4,763	3/16"	6	35	82	44	36	★ -3/16IN
	4,8		6	35	82	44	36	★ -4.8
	4,9		6	35	82	44	36	★ -4.9
	5		6	35	82	44	36	★ -5
	5,1		6	35	82	44	36	★ -5.1
	5,2		6	35	82	44	36	★ -5.2
	5,3		6	35	82	44	36	★ -5.3
	5,4		6	35	82	44	36	★ -5.4
	5,5		6	35	82	44	36	★ -5.5
	5,55		6	35	82	44	36	★ -5.55
	5,556	7/32"	6	35	82	44	36	★ -7/32IN
	5,6		6	35	82	44	36	★ -5.6
	5,7		6	35	82	44	36	★ -5.7
	5,8		6	35	82	44	36	★ -5.8
	5,9		6	35	82	44	36	★ -5.9
	5,953	15/64"	6	29	82	44	36	★ -15/64IN
	6		6	35	82	44	36	★ -6
	6,1		8	43	91	53	36	★ -6.1
	6,2		8	43	91	53	36	★ -6.2
	6,3		8	43	91	53	36	★ -6.3
	6,35	1/4"	8	43	91	53	36	★ -1/4IN
	6,4		8	43	91	53	36	★ -6.4
	6,5		8	43	91	53	36	★ -6.5
	6,6		8	43	91	53	36	★ -6.6

Continued

★ New addition to range



Solid carbide coolant through drills

A3393TTP

X-treme Inox



5 x D_c

	P	M	K	N	S	H	O
TTP	●	●	●	●	●	●	●

Continued

DIN 6537 long	D _c m7 mm	D _c Inches/No	d ₁ h6 mm	L _c mm	l ₁ mm	l ₂ mm	l ₅ mm	Designation A3393TTP
Shank DIN 6535 HA	6,7		8	43	91	53	36	★ -6.7
	6,8		8	43	91	53	36	★ -6.8
	6,9		8	43	91	53	36	★ -6.9
	7		8	43	91	53	36	★ -7
	7,1		8	43	91	53	36	★ -7.1
	7,144	9/32"	8	43	91	53	36	★ -9/32IN
	7,2		8	43	91	53	36	★ -7.2
	7,3		8	43	91	53	36	★ -7.3
	7,4		8	43	91	53	36	★ -7.4
	7,5		8	43	91	53	36	★ -7.5
	7,6		8	43	91	53	36	★ -7.6
	7,7		8	43	91	53	36	★ -7.7
	7,8		8	43	91	53	36	★ -7.8
	7,9		8	43	91	53	36	★ -7.9
	7,938	5/16"	8	43	91	53	36	★ -5/16IN
	8		8	43	91	53	36	★ -8
	8,1		10	49	103	61	40	★ -8.1
	8,2		10	49	103	61	40	★ -8.2
	8,3		10	49	103	61	40	★ -8.3
	8,4		10	49	103	61	40	★ -8.4
	8,5		10	49	103	61	40	★ -8.5
	8,6		10	49	103	61	40	★ -8.6
	8,7		10	49	103	61	40	★ -8.7
	8,731	11/32"	10	49	103	61	40	★ -11/32IN
	8,8		10	49	103	61	40	★ -8.8
	8,9		10	49	103	61	40	★ -8.9
	9		10	49	103	61	40	★ -9
	9,1		10	49	103	61	40	★ -9.1
	9,128	23/64"	10	49	103	61	40	★ -23/64IN
	9,2		10	49	103	61	40	★ -9.2
	9,3		10	49	103	61	40	★ -9.3
	9,4		10	49	103	61	40	★ -9.4
	9,5		10	49	103	61	40	★ -9.5
	9,525	3/8"	10	49	103	61	40	★ -3/8IN
	9,6		10	49	103	61	40	★ -9.6
	9,7		10	49	103	61	40	★ -9.7
	9,8		10	49	103	61	40	★ -9.8
	9,9		10	49	103	61	40	★ -9.9
	9,921	25/64"	10	49	103	61	40	★ -25/64IN
	10		10	49	103	61	40	★ -10
	10,1		12	56	118	71	45	★ -10.1
	10,2		12	56	118	71	45	★ -10.2
	10,3		12	56	118	71	45	★ -10.3
	10,319	13/32"	12	56	118	71	45	★ -13/32IN
	10,4		12	56	118	71	45	★ -10.4
	10,5		12	56	118	71	45	★ -10.5
	10,6		12	56	118	71	45	★ -10.6
	10,7		12	56	118	71	45	★ -10.7
	10,8		12	56	118	71	45	★ -10.8
	10,9		12	56	118	71	45	★ -10.9
	11		12	56	118	71	45	★ -11
	11,1		12	56	118	71	45	★ -11.1
	11,113	7/16"	12	56	118	71	45	★ -7/16IN
	11,2		12	56	118	71	45	★ -11.2
	11,3		12	56	118	71	45	★ -11.3

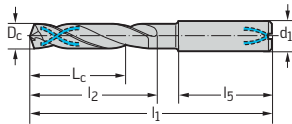

★ New addition to range



Continued

Solid carbide coolant through drills

A3393TTP

X-treme Inox

 5 x D_c

Continued

	P	M	K	N	S	H	O
TTP	●●	●●	●	●	●●	●	●

DIN 6537 long	D _c m7 mm	D _c Inches/No	d ₁ h6 mm	L _c mm	l ₁ mm	l ₂ mm	l ₅ mm	Designation A3393TTP
Shank DIN 6535 HA	11,4		12	56	118	71	45	★ -11.4
	11,5		12	56	118	71	45	★ -11.5
	11,509	29/64"	12	56	118	71	45	★ -29/64IN
	11,6		12	56	118	71	45	★ -11.6
	11,7		12	56	118	71	45	★ -11.7
	11,8		12	56	118	71	45	★ -11.8
	11,9		12	56	118	71	45	★ -11.9
	11,906	15/32"	12	56	118	71	45	★ -15/32IN
	12		12	56	118	71	45	★ -12
	12,2		14	60	124	77	45	★ -12.2
	12,5		14	60	124	77	45	★ -12.5
	12,7	1/2"	14	60	124	77	45	★ -1/2IN
	12,8		14	60	124	77	45	★ -12.8
	13		14	60	124	77	45	★ -13
	13,494	17/32"	14	60	124	77	45	★ -17/32IN
	13,5		14	60	124	77	45	★ -13.5
	13,8		14	60	124	77	45	★ -13.8
	14		14	60	124	77	45	★ -14
	14,2		16	63	133	83	48	★ -14.2
	14,288	9/16"	16	63	133	83	48	★ -9/16IN
	14,4		16	63	133	83	48	★ -14.4
	14,5		16	63	133	83	48	★ -14.5
	14,8		16	63	133	83	48	★ -14.8
	15		16	63	133	83	48	★ -15
	15,1		16	63	133	83	48	★ -15.1
	15,5		16	63	133	83	48	★ -15.5
	15,8		16	63	133	83	48	★ -15.8
	15,875	5/8"	16	63	133	83	48	★ -5/8IN
	16		16	63	133	83	48	★ -16
	16,5		18	71	143	93	48	★ -16.5
	16,8		18	71	143	93	48	★ -16.8
	17		18	71	143	93	48	★ -17
	17,5		18	71	143	93	48	★ -17.5
	17,8		18	71	143	93	48	★ -17.8
	18		18	71	143	93	48	★ -18
	18,5		20	77	153	101	50	★ -18.5
	18,8		20	77	153	101	50	★ -18.8
	19		20	77	153	101	50	★ -19
	19,05	3/4"	20	77	153	101	50	★ -3/4IN
	19,5		20	77	153	101	50	★ -19.5
	19,8		20	77	153	101	50	★ -19.8
	20		20	77	153	101	50	★ -20

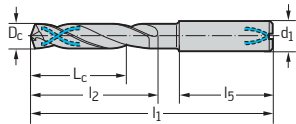

★ New addition to range



Solid carbide coolant through drills

A3399XPL

X-treme



5 x D_c

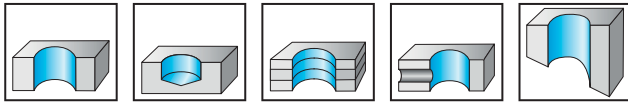

- K30F - XPL
- Type X-treme
- Right-hand cutting
- 140° point angle

Special features:

Suitable for dry machining in steel and cast iron
45 - 55 HRC

	P	M	K	N	S	H	O
XPL	●	●	●	●	●	●	●

DIN 6537 long	D _c mm	D _c Inches/No	d ₁ h6 mm	L _c mm	l ₁ mm	l ₂ mm	l ₅ mm	Designation A3399XPL
Shank DIN 6535 HA	3		6	23	66	28	36	-3
	3,1		6	23	66	28	36	-3.1
	3,175	1/8"	6	23	66	28	36	-1/8IN
	3,2		6	23	66	28	36	-3.2
	3,25		6	23	66	28	36	-3.25
	3,3		6	23	66	28	36	-3.3
	3,4		6	23	66	28	36	-3.4
	3,5		6	23	66	28	36	-3.5
	3,572	9/64"	6	23	66	28	36	-9/64IN
	3,6		6	23	66	28	36	-3.6
	3,65		6	23	66	28	36	-3.65
	3,7		6	23	66	28	36	-3.7
	3,8		6	29	74	36	36	-3.8
	3,9		6	29	74	36	36	-3.9
	3,969	5/32"	6	29	74	36	36	-5/32IN
	4		6	29	74	36	36	-4
	4,1		6	29	74	36	36	-4.1
	4,2		6	29	74	36	36	-4.2
	4,3		6	29	74	36	36	-4.3
	4,366	11/64"	6	29	74	36	36	-11/64IN
	4,4		6	29	74	36	36	-4.4
	4,5		6	29	74	36	36	-4.5
	4,6		6	29	74	36	36	-4.6
	4,65		6	29	74	36	36	-4.65
	4,7		6	29	74	36	36	-4.7
	4,763	3/16"	6	35	82	44	36	-3/16IN
	4,8		6	35	82	44	36	-4.8
	4,9		6	35	82	44	36	-4.9
	5		6	35	82	44	36	-5
	5,1		6	35	82	44	36	-5.1
	5,159	13/64"	6	35	82	44	36	-13/64IN
	5,2		6	35	82	44	36	-5.2
	5,3		6	35	82	44	36	-5.3
	5,4		6	35	82	44	36	-5.4
	5,5		6	35	82	44	36	-5.5
	5,55		6	35	82	44	36	-5.55
	5,556	7/32"	6	35	82	44	36	-7/32IN
	5,6		6	35	82	44	36	-5.6
	5,7		6	35	82	44	36	-5.7
	5,8		6	35	82	44	36	-5.8
	5,9		6	35	82	44	36	-5.9
	5,953	15/64"	6	35	82	44	36	-15/64IN
	6		6	35	82	44	36	-6
	6,1		8	43	91	53	36	-6.1
	6,2		8	43	91	53	36	-6.2
	6,3		8	43	91	53	36	-6.3
	6,35	1/4"	8	43	91	53	36	-1/4IN

Continued



Solid carbide coolant through drills

A3399XPL

X-treme

 5 x D_c

Continued

	P	M	K	N	S	H	O
XPL	●●	●●	●●	●●	●●	●●	●●

DIN 6537 long	D _c m7 mm	D _c Inches/No	d ₁ h6 mm	L _c mm	l ₁ mm	l ₂ mm	l ₅ mm	Designation A3399XPL
Shank DIN 6535 HA	6,4		8	43	91	53	36	-6.4
	6,5		8	43	91	53	36	-6.5
	6,6		8	43	91	53	36	-6.6
	6,7		8	43	91	53	36	-6.7
	6,747	17/64"	8	43	91	53	36	-17/64IN
	6,8		8	43	91	53	36	-6.8
	6,9		8	43	91	53	36	-6.9
	7		8	43	91	53	36	-7
	7,1		8	43	91	53	36	-7.1
	7,144	9/32"	8	43	91	53	36	-9/32IN
	7,2		8	43	91	53	36	-7.2
	7,3		8	43	91	53	36	-7.3
	7,4		8	43	91	53	36	-7.4
	7,5		8	43	91	53	36	-7.5
	7,541	19/64"	8	43	91	53	36	-19/64IN
	7,55		8	43	91	53	36	-7.55
	7,6		8	43	91	53	36	-7.6
	7,7		8	43	91	53	36	-7.7
	7,8		8	43	91	53	36	-7.8
	7,9		8	43	91	53	36	-7.9
	7,938	5/16"	8	43	91	53	36	-5/16IN
	8		8	43	91	53	36	-8
	8,1		10	49	103	61	40	-8.1
	8,2		10	49	103	61	40	-8.2
	8,3		10	49	103	61	40	-8.3
	8,334	21/64"	10	49	103	61	40	-21/64IN
	8,4		10	49	103	61	40	-8.4
	8,5		10	49	103	61	40	-8.5
	8,6		10	49	103	61	40	-8.6
	8,7		10	49	103	61	40	-8.7
	8,731	11/32"	10	49	103	61	40	-11/32IN
	8,8		10	49	103	61	40	-8.8
	8,9		10	49	103	61	40	-8.9
	9		10	49	103	61	40	-9
	9,1		10	49	103	61	40	-9.1
	9,128	23/64"	10	49	103	61	40	-23/64IN
	9,2		10	49	103	61	40	-9.2
	9,3		10	49	103	61	40	-9.3
	9,4		10	49	103	61	40	-9.4
	9,5		10	49	103	61	40	-9.5
	9,525	3/8"	10	49	103	61	40	-3/8IN
	9,55		10	49	103	61	40	-9.55
	9,6		10	49	103	61	40	-9.6
	9,7		10	49	103	61	40	-9.7
	9,8		10	49	103	61	40	-9.8
	9,9		10	49	103	61	40	-9.9
	9,922	25/64"	10	49	103	61	40	-25/64IN
	10		10	49	103	61	40	-10
	10,1		12	56	118	71	45	-10.1
	10,2		12	56	118	71	45	-10.2
	10,3		12	56	118	71	45	-10.3
	10,319	13/32"	12	56	118	71	45	-13/32IN
	10,4		12	56	118	71	45	-10.4
	10,5		12	56	118	71	45	-10.5
	10,6		12	56	118	71	45	-10.6

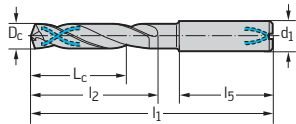

Continued



Solid carbide coolant through drills

A3399XPL

X-treme



5 x D_c

Continued

P	M	K	N	S	H	O
●	●	●	●	●	●	●

DIN 6537 long	D _c m7 mm	D _c Inches/No	d ₁ h6 mm	L _c mm	l ₁ mm	l ₂ mm	l ₅ mm	Designation A3399XPL
Shank DIN 6535 HA	10,7		12	56	118	71	45	-10.7
	10,716	27/64"	12	56	118	71	45	-27/64IN
	10,8		12	56	118	71	45	-10.8
	10,9		12	56	118	71	45	-10.9
	11		12	56	118	71	45	-11
	11,1		12	56	118	71	45	-11.1
	11,113	7/16"	12	56	118	71	45	-7/16IN
	11,2		12	56	118	71	45	-11.2
	11,3		12	56	118	71	45	-11.3
	11,4		12	56	118	71	45	-11.4
	11,5		12	56	118	71	45	-11.5
	11,509	29/64"	12	56	118	71	45	-29/64IN
	11,55		12	56	118	71	45	-11.55
	11,6		12	56	118	71	45	-11.6
	11,7		12	56	118	71	45	-11.7
	11,8		12	56	118	71	45	-11.8
	11,9		12	56	118	71	45	-11.9
	11,906	15/32"	12	56	118	71	45	-15/32IN
	12		12	56	118	71	45	-12
	12,1		14	60	124	77	45	-12.1
	12,2		14	60	124	77	45	-12.2
	12,25		14	60	124	77	45	-12.25
	12,3		14	60	124	77	45	-12.3
	12,303	31/64"	14	60	124	77	45	-31/64IN
	12,4		14	60	124	77	45	-12.4
	12,5		14	60	124	77	45	-12.5
	12,6		14	60	124	77	45	-12.6
	12,7	1/2"	14	60	124	77	45	-1/2IN
	12,75		14	60	124	77	45	-12.75
	12,8		14	60	124	77	45	-12.8
	12,9		14	60	124	77	45	-12.9
	13		14	60	124	77	45	-13
	13,1		14	60	124	77	45	-13.1
	13,2		14	60	124	77	45	-13.2
	13,3		14	60	124	77	45	-13.3
	13,4		14	60	124	77	45	-13.4
	13,494	17/32"	14	60	124	77	45	-17/32IN
	13,5		14	60	124	77	45	-13.5
	13,6		14	60	124	77	45	-13.6
	13,7		14	60	124	77	45	-13.7
	13,8		14	60	124	77	45	-13.8
	13,9		14	60	124	77	45	-13.9
	14		14	60	124	77	45	-14
	14,1		16	63	133	83	48	-14.1
	14,2		16	63	133	83	48	-14.2
	14,288	9/16"	16	63	133	83	48	-9/16IN
	14,3		16	63	133	83	48	-14.3
	14,4		16	63	133	83	48	-14.4
	14,5		16	63	133	83	48	-14.5
	14,6		16	63	133	83	48	-14.6
	14,7		16	63	133	83	48	-14.7
	14,75		16	63	133	83	48	-14.75
	14,8		16	63	133	83	48	-14.8
	14,9		16	63	133	83	48	-14.9
	15		16	63	133	83	48	-15

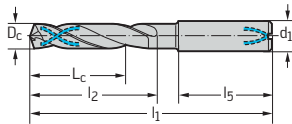

Continued

B-137

G-2

B-102

Solid carbide coolant through drills

A3399XPL

X-treme

 5 x D_c

Continued

	P	M	K	N	S	H	O
XPL	●●	●●	●●	●●	●●	●●	●●

DIN 6537 long	D _c m7 mm	D _c Inches/No	d ₁ h6 mm	L _c mm	l ₁ mm	l ₂ mm	l ₅ mm	Designation A3399XPL
Shank DIN 6535 HA	15,1		16	63	133	83	48	-15.1
	15,2		16	63	133	83	48	-15.2
	15,3		16	63	133	83	48	-15.3
	15,4		16	63	133	83	48	-15.4
	15,5		16	63	133	83	48	-15.5
	15,6		16	63	133	83	48	-15.6
	15,7		16	63	133	83	48	-15.7
	15,8		16	63	133	83	48	-15.8
	15,875	5/8"	16	63	133	83	48	-5/8IN
	15,9		16	63	133	83	48	-15.9
	16		16	63	133	83	48	-16
	16,1		18	71	143	93	48	-16.1
	16,2		18	71	143	93	48	-16.2
	16,3		18	71	143	93	48	-16.3
	16,4		18	71	143	93	48	-16.4
	16,5		18	71	143	93	48	-16.5
	16,6		18	71	143	93	48	-16.6
	16,7		18	71	143	93	48	-16.7
	16,75		18	71	143	93	48	-16.75
	16,8		18	71	143	93	48	-16.8
	16,9		18	71	143	93	48	-16.9
	17		18	71	143	93	48	-17
	17,1		18	71	143	93	48	-17.1
	17,2		18	71	143	93	48	-17.2
	17,3		18	71	143	93	48	-17.3
	17,4		18	71	143	93	48	-17.4
	17,5		18	71	143	93	48	-17.5
	17,6		18	71	143	93	48	-17.6
	17,7		18	71	143	93	48	-17.7
	17,8		18	71	143	93	48	-17.8
	17,9		18	71	143	93	48	-17.9
	18		18	71	143	93	48	-18
	18,1		20	77	153	101	50	-18.1
	18,2		20	77	153	101	50	-18.2
	18,3		20	77	153	101	50	-18.3
	18,4		20	77	153	101	50	-18.4
	18,5		20	77	153	101	50	-18.5
	18,6		20	77	153	101	50	-18.6
	18,7		20	77	153	101	50	-18.7
	18,8		20	77	153	101	50	-18.8
	18,9		20	77	153	101	50	-18.9
	19		20	77	153	101	50	-19
	19,05	3/4"	20	77	153	101	50	-3/4IN
	19,1		20	77	153	101	50	-19.1
	19,2		20	77	153	101	50	-19.2
	19,3		20	77	153	101	50	-19.3
	19,4		20	77	153	101	50	-19.4
	19,5		20	77	153	101	50	-19.5
	19,6		20	77	153	101	50	-19.6
	19,7		20	77	153	101	50	-19.7
	19,8		20	77	153	101	50	-19.8
	19,9		20	77	153	101	50	-19.9
	20		20	77	153	101	50	-20
	20,5		25	86	166	108	56	-20.5
	21		25	86	166	108	56	-21

Continued



Solid carbide coolant through drills A3399XPL X-treme



5 x D_c

Continued

	P	M	K	N	S	H	0
XPL	●	●	●	●	●	●	

DIN 6537 long	D _c m7 mm	D _c Inches/No	d ₁ h6 mm	L _c mm	l ₁ mm	l ₂ mm	l ₅ mm	Designation A3399XPL
Shank DIN 6535 HA	21,5		25	86	166	108	56	-21.5
	22		25	86	166	108	56	-22
	22,5		25	91	173	115	56	-22.5
	23		25	91	173	115	56	-23
	23,5		25	91	173	115	56	-23.5
	24		25	91	173	115	56	-24
	24,5		25	97	180	122	56	-24.5
	25		25	97	180	122	56	-25

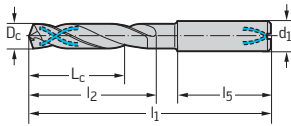

Solid carbide twist drill

A3879XPL

X-treme



3 x D_c

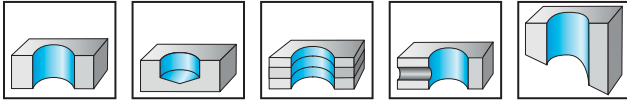

- K30F - XPL
- Type X-treme
- Right-hand cutting
- 140° point angle

Special features:

Suitable for dry machining in steel and cast iron
45 - 55 HRC

	P	M	K	N	S	H	O
XPL	●●	●●	●●	●●	●●	●●	●●

DIN 6537 short	D _c m7 mm	d ₁ h6 mm	L _c mm	l ₁ mm	l ₂ mm	l ₅ mm	Designation A3879XPL
Shank DIN 6535 HE	3	6	14	62	20	36	★ -3
	3,1	6	14	62	20	36	★ -3.1
	3,2	6	14	62	20	36	★ -3.2
	3,25	6	14	62	20	36	★ -3.25
	3,3	6	14	62	20	36	★ -3.3
	3,4	6	14	62	20	36	★ -3.4
	3,5	6	14	62	20	36	★ -3.5
	3,6	6	14	62	20	36	★ -3.6
	3,65	6	14	62	20	36	★ -3.65
	3,7	6	14	62	20	36	★ -3.7
	3,8	6	17	66	24	36	★ -3.8
	3,9	6	17	66	24	36	★ -3.9
	4	6	17	66	24	36	★ -4
	4,1	6	17	66	24	36	★ -4.1
	4,2	6	17	66	24	36	★ -4.2
	4,3	6	17	66	24	36	★ -4.3
	4,4	6	17	66	24	36	★ -4.4
	4,5	6	17	66	24	36	★ -4.5
	4,6	6	17	66	24	36	★ -4.6
	4,65	6	17	66	24	36	★ -4.65
	4,7	6	17	66	24	36	★ -4.7
	4,8	6	20	66	28	36	★ -4.8
	4,9	6	20	66	28	36	★ -4.9
	5	6	20	66	28	36	★ -5
	5,1	6	20	66	28	36	★ -5.1
	5,2	6	20	66	28	36	★ -5.2
	5,3	6	20	66	28	36	★ -5.3
	5,4	6	20	66	28	36	★ -5.4
	5,5	6	20	66	28	36	★ -5.5
	5,55	6	20	66	28	36	★ -5.55
	5,6	6	20	66	28	36	★ -5.6
	5,7	6	20	66	28	36	★ -5.7
	5,8	6	20	66	28	36	★ -5.8
	5,9	6	20	66	28	36	★ -5.9
	6	6	20	66	28	36	★ -6
	6,1	8	24	79	34	36	★ -6.1
	6,2	8	24	79	34	36	★ -6.2
	6,3	8	24	79	34	36	★ -6.3
	6,4	8	24	79	34	36	★ -6.4
	6,5	8	24	79	34	36	★ -6.5
	6,6	8	24	79	34	36	★ -6.6
	6,7	8	24	79	34	36	★ -6.7
	6,8	8	24	79	34	36	★ -6.8
	6,9	8	24	79	34	36	★ -6.9
	7	8	24	79	34	36	★ -7
	7,1	8	29	79	41	36	★ -7.1
	7,2	8	29	79	41	36	★ -7.2

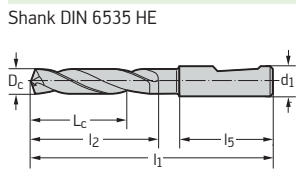

Continued

★ New addition to range



Solid carbide twist drill

A3879XPL

X-treme



3 x D_c

	P	M	K	N	S	H	O
XPL	●●	●●	●●	●●	●●	●●	●●

Continued

DIN 6537 short	D _c m7 mm	d ₁ h6 mm	L _c mm	l ₁ mm	l ₂ mm	l ₅ mm	Designation A3879XPL
Shank DIN 6535 HE	7,3	8	29	79	41	36	★ -7.3
	7,4	8	29	79	41	36	★ -7.4
	7,5	8	29	79	41	36	★ -7.5
	7,55	8	29	79	41	36	★ -7.55
	7,6	8	29	79	41	36	★ -7.6
	7,7	8	29	79	41	36	★ -7.7
	7,8	8	29	79	41	36	★ -7.8
	7,9	8	29	79	41	36	★ -7.9
	8	8	29	79	41	36	★ -8
	8,1	10	35	89	47	40	★ -8.1
	8,2	10	35	89	47	40	★ -8.2
	8,3	10	35	89	47	40	★ -8.3
	8,4	10	35	89	47	40	★ -8.4
	8,5	10	35	89	47	40	★ -8.5
	8,6	10	35	89	47	40	★ -8.6
	8,7	10	35	89	47	40	★ -8.7
	8,8	10	35	89	47	40	★ -8.8
	8,9	10	35	89	47	40	★ -8.9
	9	10	35	89	47	40	★ -9
	9,1	10	35	89	47	40	★ -9.1
	9,2	10	35	89	47	40	★ -9.2
	9,3	10	35	89	47	40	★ -9.3
	9,4	10	35	89	47	40	★ -9.4
	9,5	10	35	89	47	40	★ -9.5
	9,55	10	35	89	47	40	★ -9.55
	9,6	10	35	89	47	40	★ -9.6
	9,7	10	35	89	47	40	★ -9.7
	9,8	10	35	89	47	40	★ -9.8
	9,9	10	35	89	47	40	★ -9.9
	10	10	35	89	47	40	★ -10
	10,1	12	40	102	55	45	★ -10.1
	10,2	12	40	102	55	45	★ -10.2
	10,3	12	40	102	55	45	★ -10.3
	10,4	12	40	102	55	45	★ -10.4
	10,5	12	40	102	55	45	★ -10.5
	10,6	12	40	102	55	45	★ -10.6
	10,7	12	40	102	55	45	★ -10.7
	10,8	12	40	102	55	45	★ -10.8
	10,9	12	40	102	55	45	★ -10.9
	11	12	40	102	55	45	★ -11
	11,1	12	40	102	55	45	★ -11.1
	11,2	12	40	102	55	45	★ -11.2
	11,3	12	40	102	55	45	★ -11.3
	11,4	12	40	102	55	45	★ -11.4
	11,5	12	40	102	55	45	★ -11.5
	11,55	12	40	102	55	45	★ -11.55
	11,6	12	40	102	55	45	★ -11.6
	11,7	12	40	102	55	45	★ -11.7
	11,8	12	40	102	55	45	★ -11.8
	11,9	12	40	102	55	45	★ -11.9
	12	12	40	102	55	45	★ -12
	12,1	14	43	107	60	45	★ -12.1
	12,2	14	43	107	60	45	★ -12.2
	12,25	14	43	107	60	45	★ -12.25
	12,3	14	43	107	60	45	★ -12.3

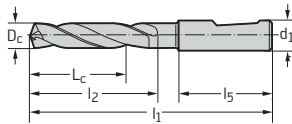

★ New addition to range

Continued

B-137

G-2

B-102

Solid carbide twist drill

A3879XPL

X-treme

 3 x D_c

Continued

	P	M	K	N	S	H	O
XPL	●●	●●	●●	●●	●●	●●	●●

DIN 6537 short	D _c m7 mm	d ₁ h6 mm	L _c mm	l ₁ mm	l ₂ mm	l ₅ mm	Designation A3879XPL
Shank DIN 6535 HE	12,4	14	43	107	60	45	★ -12.4
	12,5	14	43	107	60	45	★ -12.5
	12,6	14	43	107	60	45	★ -12.6
	12,7	14	43	107	60	45	★ -12.7
	12,75	14	43	107	60	45	★ -12.75
	12,8	14	43	107	60	45	★ -12.8
	12,9	14	43	107	60	45	★ -12.9
	13	14	43	107	60	45	★ -13
	13,1	14	43	107	60	45	★ -13.1
	13,2	14	43	107	60	45	★ -13.2
	13,3	14	43	107	60	45	★ -13.3
	13,4	14	43	107	60	45	★ -13.4
	13,5	14	43	107	60	45	★ -13.5
	13,6	14	43	107	60	45	★ -13.6
	13,7	14	43	107	60	45	★ -13.7
	13,8	14	43	107	60	45	★ -13.8
	13,9	14	43	107	60	45	★ -13.9
	14	14	43	107	60	45	★ -14
	14,2	16	45	115	65	48	★ -14.2
	14,3	16	45	115	65	48	★ -14.3
	14,4	16	45	115	65	48	★ -14.4
	14,5	16	45	115	65	48	★ -14.5
	14,6	16	45	115	65	48	★ -14.6
	14,7	16	45	115	65	48	★ -14.7
	14,75	16	45	115	65	48	★ -14.75
	14,8	16	45	115	65	48	★ -14.8
	15	16	45	115	65	48	★ -15
	15,1	16	45	115	65	48	★ -15.1
	15,2	16	45	115	65	48	★ -15.2
	15,3	16	45	115	65	48	★ -15.3
	15,5	16	45	115	65	48	★ -15.5
	15,6	16	45	115	65	48	★ -15.6
	15,7	16	45	115	65	48	★ -15.7
	15,8	16	45	115	65	48	★ -15.8
	15,9	16	45	115	65	48	★ -15.9
	16	16	45	115	65	48	★ -16
	16,1	18	51	123	73	48	★ -16.1
	16,2	18	51	123	73	48	★ -16.2
	16,3	18	51	123	73	48	★ -16.3
	16,4	18	51	123	73	48	★ -16.4
	16,5	18	51	123	73	48	★ -16.5
	16,6	18	51	123	73	48	★ -16.6
	16,7	18	51	123	73	48	★ -16.7
	16,75	18	51	123	73	48	★ -16.75
	16,8	18	51	123	73	48	★ -16.8
	17	18	51	123	73	48	★ -17
	17,2	18	51	123	73	48	★ -17.2
	17,3	18	51	123	73	48	★ -17.3
	17,5	18	51	123	73	48	★ -17.5
	17,6	18	51	123	73	48	★ -17.6
	17,7	18	51	123	73	48	★ -17.7
	17,8	18	51	123	73	48	★ -17.8
	18	18	51	123	73	48	★ -18
	18,2	20	55	131	79	50	★ -18.2
	18,5	20	55	131	79	50	★ -18.5

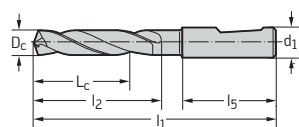

Continued

★ New addition to range



Solid carbide twist drill
A3879XPL
X-treme



3 x D_c

	P	M	K	N	S	H	O
XPL	●●	●●	●●	●●	●●	●●	●●

Continued

DIN 6537 short	D _c m7 mm	d ₁ h6 mm	L _c mm	l ₁ mm	l ₂ mm	l ₅ mm	Designation A3879XPL
Shank DIN 6535 HE	18,7	20	55	131	79	50	★ -18.7
	18,8	20	55	131	79	50	★ -18.8
	19	20	55	131	79	50	★ -19
	19,5	20	55	131	79	50	★ -19.5
	19,7	20	55	131	79	50	★ -19.7
	19,8	20	55	131	79	50	★ -19.8
	20	20	55	131	79	50	★ -20

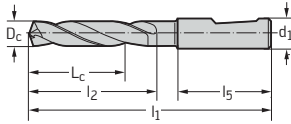

★ New addition to range



Solid carbide coolant through drills

A3899XPL

X-treme



3 x D_c

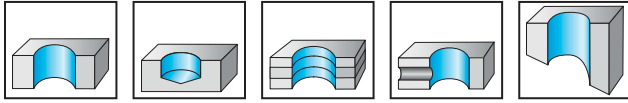

- K30F - XPL
- Type X-treme
- Right-hand cutting
- 140° point angle

Special features:

Suitable for dry machining in steel and cast iron
45 - 55 HRC

	P	M	K	N	S	H	O
XPL	●●	●●	●●	●●	●●	●●	

DIN 6537 short	D _c m7 mm	d ₁ h6 mm	L _c mm	l ₁ mm	l ₂ mm	l ₅ mm	Designation A3899XPL
Shank DIN 6535 HE	3	6	14	62	20	36	★ -3
	3,1	6	14	62	20	36	★ -3.1
	3,2	6	14	62	20	36	★ -3.2
	3,25	6	14	62	20	36	★ -3.25
	3,3	6	14	62	20	36	★ -3.3
	3,4	6	14	62	20	36	★ -3.4
	3,5	6	14	62	20	36	★ -3.5
	3,6	6	14	62	20	36	★ -3.6
	3,65	6	14	62	20	36	★ -3.65
	3,7	6	14	62	20	36	★ -3.7
	3,8	6	17	66	24	36	★ -3.8
	3,9	6	17	66	24	36	★ -3.9
	4	6	17	66	24	36	★ -4
	4,1	6	17	66	24	36	★ -4.1
	4,2	6	17	66	24	36	★ -4.2
	4,3	6	17	66	24	36	★ -4.3
	4,4	6	17	66	24	36	★ -4.4
	4,5	6	17	66	24	36	★ -4.5
	4,6	6	17	66	24	36	★ -4.6
	4,65	6	17	66	24	36	★ -4.65
	4,7	6	17	66	24	36	★ -4.7
	4,8	6	20	66	28	36	★ -4.8
	4,9	6	20	66	28	36	★ -4.9
	5	6	20	66	28	36	★ -5
	5,1	6	20	66	28	36	★ -5.1
	5,2	6	20	66	28	36	★ -5.2
	5,3	6	20	66	28	36	★ -5.3
	5,4	6	20	66	28	36	★ -5.4
	5,5	6	20	66	28	36	★ -5.5
	5,55	6	20	66	28	36	★ -5.55
	5,6	6	20	66	28	36	★ -5.6
	5,7	6	20	66	28	36	★ -5.7
	5,8	6	20	66	28	36	★ -5.8
	5,9	6	20	66	28	36	★ -5.9
	6	6	20	66	28	36	★ -6
	6,1	8	24	79	34	36	★ -6.1
	6,2	8	24	79	34	36	★ -6.2
	6,3	8	24	79	34	36	★ -6.3
	6,4	8	24	79	34	36	★ -6.4
	6,5	8	24	79	34	36	★ -6.5
	6,6	8	24	79	34	36	★ -6.6
	6,7	8	24	79	34	36	★ -6.7
	6,8	8	24	79	34	36	★ -6.8
	6,9	8	24	79	34	36	★ -6.9
	7	8	24	79	34	36	★ -7
	7,1	8	29	79	41	36	★ -7.1
	7,2	8	29	79	41	36	★ -7.2

Continued

★ New addition to range



Solid carbide coolant through drills

A3899XPL

X-treme



3 x D_c

	P	M	K	N	S	H	O
XPL	●●	●●	●●	●●	●●	●●	●●

Continued

DIN 6537 short	D _c m7 mm	d ₁ h6 mm	L _c mm	l ₁ mm	l ₂ mm	l ₅ mm	Designation A3899XPL
Shank DIN 6535 HE	7,3	8	29	79	41	36	★ -7.3
	7,4	8	29	79	41	36	★ -7.4
	7,5	8	29	79	41	36	★ -7.5
	7,55	8	29	79	41	36	★ -7.55
	7,6	8	29	79	41	36	★ -7.6
	7,7	8	29	79	41	36	★ -7.7
	7,8	8	29	79	41	36	★ -7.8
	7,9	8	29	79	41	36	★ -7.9
	8	8	29	79	41	36	★ -8
	8,1	10	35	89	47	40	★ -8.1
	8,2	10	35	89	47	40	★ -8.2
	8,3	10	35	89	47	40	★ -8.3
	8,4	10	35	89	47	40	★ -8.4
	8,5	10	35	89	47	40	★ -8.5
	8,6	10	35	89	47	40	★ -8.6
	8,7	10	35	89	47	40	★ -8.7
	8,8	10	35	89	47	40	★ -8.8
	8,9	10	35	89	47	40	★ -8.9
	9	10	35	89	47	40	★ -9
	9,1	10	35	89	47	40	★ -9.1
	9,2	10	35	89	47	40	★ -9.2
	9,3	10	35	89	47	40	★ -9.3
	9,4	10	35	89	47	40	★ -9.4
	9,5	10	35	89	47	40	★ -9.5
	9,55	10	35	89	47	40	★ -9.55
	9,6	10	35	89	47	40	★ -9.6
	9,7	10	35	89	47	40	★ -9.7
	9,8	10	35	89	47	40	★ -9.8
	9,9	10	35	89	47	40	★ -9.9
	10	10	35	89	47	40	★ -10
	10,1	12	40	102	55	45	★ -10.1
	10,2	12	40	102	55	45	★ -10.2
	10,3	12	40	102	55	45	★ -10.3
	10,4	12	40	102	55	45	★ -10.4
	10,5	12	40	102	55	45	★ -10.5
	10,6	12	40	102	55	45	★ -10.6
	10,7	12	40	102	55	45	★ -10.7
	10,8	12	40	102	55	45	★ -10.8
	10,9	12	40	102	55	45	★ -10.9
	11	12	40	102	55	45	★ -11
	11,1	12	40	102	55	45	★ -11.1
	11,2	12	40	102	55	45	★ -11.2
	11,3	12	40	102	55	45	★ -11.3
	11,4	12	40	102	55	45	★ -11.4
	11,5	12	40	102	55	45	★ -11.5
	11,55	12	40	102	55	45	★ -11.55
	11,6	12	40	102	55	45	★ -11.6
	11,7	12	40	102	55	45	★ -11.7
	11,8	12	40	102	55	45	★ -11.8
	11,9	12	40	102	55	45	★ -11.9
	12	12	40	102	55	45	★ -12
	12,1	14	43	107	60	45	★ -12.1
	12,2	14	43	107	60	45	★ -12.2
	12,25	14	43	107	60	45	★ -12.25
	12,3	14	43	107	60	45	★ -12.3

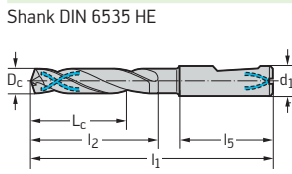

★ New addition to range

Continued

B-137

G-2

B-102

Solid carbide coolant through drills

A3899XPL

X-treme

 3 x D_c

Continued

	P	M	K	N	S	H	O
XPL	●●	●●	●●	●●	●●	●●	●●

DIN 6537 short	D _c m7 mm	d ₁ h6 mm	L _c mm	l ₁ mm	l ₂ mm	l ₅ mm	Designation A3899XPL
Shank DIN 6535 HE	12,4	14	43	107	60	45	★ -12.4
	12,5	14	43	107	60	45	★ -12.5
	12,6	14	43	107	60	45	★ -12.6
	12,7	14	43	107	60	45	★ -12.7
	12,75	14	43	107	60	45	★ -12.75
	12,8	14	43	107	60	45	★ -12.8
	12,9	14	43	107	60	45	★ -12.9
	13	14	43	107	60	45	★ -13
	13,1	14	43	107	60	45	★ -13.1
	13,2	14	43	107	60	45	★ -13.2
	13,3	14	43	107	60	45	★ -13.3
	13,4	14	43	107	60	45	★ -13.4
	13,5	14	43	107	60	45	★ -13.5
	13,6	14	43	107	60	45	★ -13.6
	13,7	14	43	107	60	45	★ -13.7
	13,8	14	43	107	60	45	★ -13.8
	13,9	14	43	107	60	45	★ -13.9
	14	14	43	107	60	45	★ -14
	14,1	16	45	115	65	48	★ -14.1
	14,2	16	45	115	65	48	★ -14.2
	14,3	16	45	115	65	48	★ -14.3
	14,4	16	45	115	65	48	★ -14.4
	14,5	16	45	115	65	48	★ -14.5
	14,6	16	45	115	65	48	★ -14.6
	14,7	16	45	115	65	48	★ -14.7
	14,75	16	45	115	65	48	★ -14.75
	14,8	16	45	115	65	48	★ -14.8
	15	16	45	115	65	48	★ -15
	15,1	16	45	115	65	48	★ -15.1
	15,2	16	45	115	65	48	★ -15.2
	15,3	16	45	115	65	48	★ -15.3
	15,5	16	45	115	65	48	★ -15.5
	15,6	16	45	115	65	48	★ -15.6
	15,7	16	45	115	65	48	★ -15.7
	15,8	16	45	115	65	48	★ -15.8
	15,9	16	45	115	65	48	★ -15.9
	16	16	45	115	65	48	★ -16
	16,1	18	51	123	73	48	★ -16.1
	16,2	18	51	123	73	48	★ -16.2
	16,3	18	51	123	73	48	★ -16.3
	16,4	18	51	123	73	48	★ -16.4
	16,5	18	51	123	73	48	★ -16.5
	16,6	18	51	123	73	48	★ -16.6
	16,7	18	51	123	73	48	★ -16.7
	16,75	18	51	123	73	48	★ -16.75
	16,8	18	51	123	73	48	★ -16.8
	17	18	51	123	73	48	★ -17
	17,2	18	51	123	73	48	★ -17.2
	17,3	18	51	123	73	48	★ -17.3
	17,5	18	51	123	73	48	★ -17.5
	17,6	18	51	123	73	48	★ -17.6
	17,7	18	51	123	73	48	★ -17.7
	17,8	18	51	123	73	48	★ -17.8
	18	18	51	123	73	48	★ -18
	18,2	20	55	131	79	50	★ -18.2

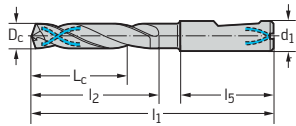

Continued

★ New addition to range





Solid carbide coolant through drills

A3899XPL

X-treme

3 x D_c

Continued

	P	M	K	N	S	H	O
XPL	●●	●●	●●	●●	●●	●●	

DIN 6537 short	D _c m7 mm	d ₁ h6 mm	L _c mm	l ₁ mm	l ₂ mm	l ₅ mm	Designation A3899XPL
Shank DIN 6535 HE	18,5	20	55	131	79	50	★ -18.5
	18,7	20	55	131	79	50	★ -18.7
	18,8	20	55	131	79	50	★ -18.8
	19	20	55	131	79	50	★ -19
	19,5	20	55	131	79	50	★ -19.5
	19,7	20	55	131	79	50	★ -19.7
	19,8	20	55	131	79	50	★ -19.8
	20	20	55	131	79	50	★ -20

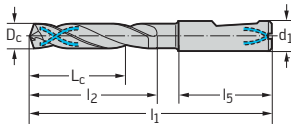

★ New addition to range



Solid carbide twist drill

A3979XPL

X-treme



5 x D_c

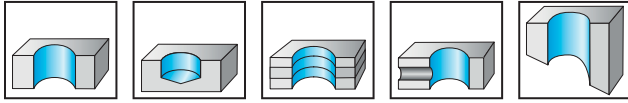

- K30F - XPL
- Type X-treme
- Right-hand cutting
- 140° point angle

Special features:

Suitable for dry machining in steel and cast iron
45 - 55 HRC

	P	M	K	N	S	H	O
XPL	●●	●●	●●	●●	●●	●●	●●

DIN 6537 long	D _c m7 mm	d ₁ h6 mm	L _c mm	l ₁ mm	l ₂ mm	l ₅ mm	Designation A3979XPL
Shank DIN 6535 HE	3	6	23	66	28	36	★ -3
	3,1	6	23	66	28	36	★ -3.1
	3,2	6	23	66	28	36	★ -3.2
	3,25	6	23	66	28	36	★ -3.25
	3,3	6	23	66	28	36	★ -3.3
	3,4	6	23	66	28	36	★ -3.4
	3,5	6	23	66	28	36	★ -3.5
	3,6	6	23	66	28	36	★ -3.6
	3,65	6	23	66	28	36	★ -3.65
	3,7	6	23	66	28	36	★ -3.7
	3,8	6	29	74	36	36	★ -3.8
	3,9	6	29	74	36	36	★ -3.9
	4	6	29	74	36	36	★ -4
	4,1	6	29	74	36	36	★ -4.1
	4,2	6	29	74	36	36	★ -4.2
	4,3	6	29	74	36	36	★ -4.3
	4,4	6	29	74	36	36	★ -4.4
	4,5	6	29	74	36	36	★ -4.5
	4,6	6	29	74	36	36	★ -4.6
	4,65	6	29	74	36	36	★ -4.65
	4,7	6	29	74	36	36	★ -4.7
	4,8	6	35	82	44	36	★ -4.8
	4,9	6	35	82	44	36	★ -4.9
	5	6	35	82	44	36	★ -5
	5,1	6	35	82	44	36	★ -5.1
	5,2	6	35	82	44	36	★ -5.2
	5,3	6	35	82	44	36	★ -5.3
	5,4	6	35	82	44	36	★ -5.4
	5,5	6	35	82	44	36	★ -5.5
	5,55	6	35	82	44	36	★ -5.55
	5,6	6	35	82	44	36	★ -5.6
	5,7	6	35	82	44	36	★ -5.7
	5,8	6	35	82	44	36	★ -5.8
	5,9	6	35	82	44	36	★ -5.9
	6	6	35	82	44	36	★ -6
	6,1	8	43	91	53	36	★ -6.1
	6,2	8	43	91	53	36	★ -6.2
	6,3	8	43	91	53	36	★ -6.3
	6,4	8	43	91	53	36	★ -6.4
	6,5	8	43	91	53	36	★ -6.5
	6,6	8	43	91	53	36	★ -6.6
	6,7	8	43	91	53	36	★ -6.7
	6,8	8	43	91	53	36	★ -6.8
	6,9	8	43	91	53	36	★ -6.9
	7	8	43	91	53	36	★ -7
	7,1	8	43	91	53	36	★ -7.1
	7,2	8	43	91	53	36	★ -7.2

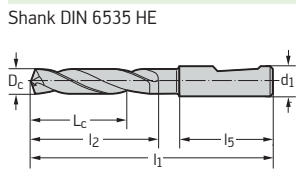

Continued

★ New addition to range



Solid carbide twist drill A3979XPL X-treme



5 x D_c

	P	M	K	N	S	H	O
XPL	●●	●●	●●	●●	●●	●●	●●

Continued

DIN 6537 long	D _c m7 mm	d ₁ h6 mm	L _c mm	l ₁ mm	l ₂ mm	l ₅ mm	Designation A3979XPL
Shank DIN 6535 HE	7,3	8	43	91	53	36	★ -7.3
	7,4	8	43	91	53	36	★ -7.4
	7,5	8	43	91	53	36	★ -7.5
	7,55	8	43	91	53	36	★ -7.55
	7,6	8	43	91	53	36	★ -7.6
	7,7	8	43	91	53	36	★ -7.7
	7,8	8	43	91	53	36	★ -7.8
	7,9	8	43	91	53	36	★ -7.9
	8	8	43	91	53	36	★ -8
	8,1	10	49	103	61	40	★ -8.1
	8,2	10	49	103	61	40	★ -8.2
	8,3	10	49	103	61	40	★ -8.3
	8,4	10	49	103	61	40	★ -8.4
	8,5	10	49	103	61	40	★ -8.5
	8,6	10	49	103	61	40	★ -8.6
	8,7	10	49	103	61	40	★ -8.7
	8,8	10	49	103	61	40	★ -8.8
	8,9	10	49	103	61	40	★ -8.9
	9	10	49	103	61	40	★ -9
	9,1	10	49	103	61	40	★ -9.1
	9,2	10	49	103	61	40	★ -9.2
	9,3	10	49	103	61	40	★ -9.3
	9,4	10	49	103	61	40	★ -9.4
	9,5	10	49	103	61	40	★ -9.5
	9,55	10	49	103	61	40	★ -9.55
	9,6	10	49	103	61	40	★ -9.6
	9,7	10	49	103	61	40	★ -9.7
	9,8	10	49	103	61	40	★ -9.8
	9,9	10	49	103	61	40	★ -9.9
	10	10	49	103	61	40	★ -10
	10,1	12	56	118	71	45	★ -10.1
	10,2	12	56	118	71	45	★ -10.2
	10,3	12	56	118	71	45	★ -10.3
	10,4	12	56	118	71	45	★ -10.4
	10,5	12	56	118	71	45	★ -10.5
	10,6	12	56	118	71	45	★ -10.6
	10,7	12	56	118	71	45	★ -10.7
	10,8	12	56	118	71	45	★ -10.8
	10,9	12	56	118	71	45	★ -10.9
	11	12	56	118	71	45	★ -11
	11,1	12	56	118	71	45	★ -11.1
	11,2	12	56	118	71	45	★ -11.2
	11,3	12	56	118	71	45	★ -11.3
	11,4	12	56	118	71	45	★ -11.4
	11,5	12	56	118	71	45	★ -11.5
	11,55	12	56	118	71	45	★ -11.55
	11,6	12	56	118	71	45	★ -11.6
	11,7	12	56	118	71	45	★ -11.7
	11,8	12	56	118	71	45	★ -11.8
	11,9	12	56	118	71	45	★ -11.9
	12	12	56	118	71	45	★ -12
	12,1	14	60	124	77	45	★ -12.1
	12,2	14	60	124	77	45	★ -12.2
	12,25	14	60	124	77	45	★ -12.25
	12,3	14	60	124	77	45	★ -12.3

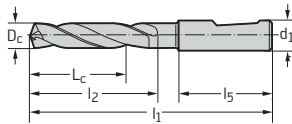

★ New addition to range

Continued

B-137

G-2

B-102

Solid carbide twist drill

A3979XPL

X-treme

 5 x D_c

Continued

	P	M	K	N	S	H	O
XPL	●●	●●	●●	●●	●●	●●	●●

DIN 6537 long	D _c m7 mm	d ₁ h6 mm	L _c mm	l ₁ mm	l ₂ mm	l ₅ mm	Designation A3979XPL
Shank DIN 6535 HE	12,4	14	60	124	77	45	★ -12.4
	12,5	14	60	124	77	45	★ -12.5
	12,6	14	60	124	77	45	★ -12.6
	12,7	14	60	124	77	45	★ -12.7
	12,75	14	60	124	77	45	★ -12.75
	12,8	14	60	124	77	45	★ -12.8
	12,9	14	60	124	77	45	★ -12.9
	13	14	60	124	77	45	★ -13
	13,1	14	60	124	77	45	★ -13.1
	13,2	14	60	124	77	45	★ -13.2
	13,3	14	60	124	77	45	★ -13.3
	13,4	14	60	124	77	45	★ -13.4
	13,5	14	60	124	77	45	★ -13.5
	13,6	14	60	124	77	45	★ -13.6
	13,7	14	60	124	77	45	★ -13.7
	13,8	14	60	124	77	45	★ -13.8
	13,9	14	60	124	77	45	★ -13.9
	14	14	60	124	77	45	★ -14
	14,1	16	63	133	83	48	★ -14.1
	14,2	16	63	133	83	48	★ -14.2
	14,3	16	63	133	83	48	★ -14.3
	14,4	16	63	133	83	48	★ -14.4
	14,5	16	63	133	83	48	★ -14.5
	14,6	16	63	133	83	48	★ -14.6
	14,7	16	63	133	83	48	★ -14.7
	14,75	16	63	133	83	48	★ -14.75
	14,8	16	63	133	83	48	★ -14.8
	15	16	63	133	83	48	★ -15
	15,1	16	63	133	83	48	★ -15.1
	15,2	16	63	133	83	48	★ -15.2
	15,3	16	63	133	83	48	★ -15.3
	15,5	16	63	133	83	48	★ -15.5
	15,6	16	63	133	83	48	★ -15.6
	15,7	16	63	133	83	48	★ -15.7
	15,8	16	63	133	83	48	★ -15.8
	15,9	16	63	133	83	48	★ -15.9
	16	16	63	133	83	48	★ -16
	16,1	18	71	143	93	48	★ -16.1
	16,2	18	71	143	93	48	★ -16.2
	16,3	18	71	143	93	48	★ -16.3
	16,4	18	71	143	93	48	★ -16.4
	16,5	18	71	143	93	48	★ -16.5
	16,6	18	71	143	93	48	★ -16.6
	16,7	18	71	143	93	48	★ -16.7
	16,75	18	71	143	93	48	★ -16.75
	16,8	18	71	143	93	48	★ -16.8
	17	18	71	143	93	48	★ -17
	17,2	18	71	143	93	48	★ -17.2
	17,3	18	71	143	93	48	★ -17.3
	17,5	18	71	143	93	48	★ -17.5
	17,6	18	71	143	93	48	★ -17.6
	17,7	18	71	143	93	48	★ -17.7
	17,8	18	71	143	93	48	★ -17.8
	18	18	71	143	93	48	★ -18
	18,2	20	77	153	101	50	★ -18.2

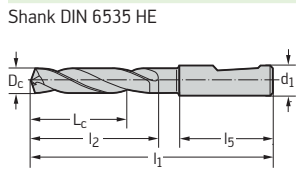

Continued

★ New addition to range



Solid carbide twist drill A3979XPL X-treme



5 x D_c

	P	M	K	N	S	H	O
XPL	●●	●●	●●	●●	●●	●●	●●

Continued

DIN 6537 long	D _c m7 mm	d ₁ h6 mm	L _c mm	l ₁ mm	l ₂ mm	l ₅ mm	Designation A3979XPL
Shank DIN 6535 HE	18,5	20	77	153	101	50	★ -18.5
	18,7	20	77	153	101	50	★ -18.7
	18,8	20	77	153	101	50	★ -18.8
	19	20	77	153	101	50	★ -19
	19,5	20	77	153	101	50	★ -19.5
	19,7	20	77	153	101	50	★ -19.7
	19,8	20	77	153	101	50	★ -19.8
	20	20	77	153	101	50	★ -20
	20,5	25	86	166	108	56	★ -20.5
	21	25	86	166	108	56	★ -21
	21,5	25	86	166	108	56	★ -21.5
	22	25	86	166	108	56	★ -22
	22,5	25	91	173	115	56	★ -22.5
	23	25	91	173	115	56	★ -23
	23,5	25	91	173	115	56	★ -23.5
	24	25	91	173	115	56	★ -24
	24,5	25	97	180	122	56	★ -24.5
	25	25	97	180	122	56	★ -25

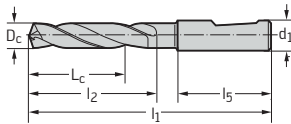

★ New addition to range



Solid carbide coolant through drills

A3999XPL

X-treme



5 x D_c

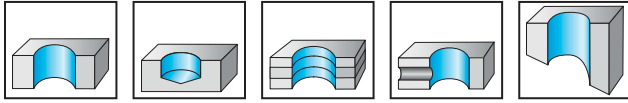

- K30F - XPL
- Type X-treme
- Right-hand cutting
- 140° point angle

Special features:

Suitable for dry machining in steel and cast iron
45 - 55 HRC

	P	M	K	N	S	H	O
XPL	●●	●●	●●	●●	●●	●●	●●

DIN 6537 long	D _c m7 mm	d ₁ h6 mm	L _c mm	l ₁ mm	l ₂ mm	l ₅ mm	Designation A3999XPL
Shank DIN 6535 HE	3	6	23	66	28	36	-3
	3,1	6	23	66	28	36	-3.1
	3,2	6	23	66	28	36	-3.2
	3,25	6	23	66	28	36	-3.25
	3,3	6	23	66	28	36	-3.3
	3,4	6	23	66	28	36	-3.4
	3,5	6	23	66	28	36	-3.5
	3,6	6	23	66	28	36	-3.6
	3,65	6	23	66	28	36	-3.65
	3,7	6	23	66	28	36	-3.7
	3,8	6	29	74	36	36	-3.8
	3,9	6	29	74	36	36	-3.9
	4	6	29	74	36	36	-4
	4,1	6	29	74	36	36	-4.1
	4,2	6	29	74	36	36	-4.2
	4,3	6	29	74	36	36	-4.3
	4,4	6	29	74	36	36	-4.4
	4,5	6	29	74	36	36	-4.5
	4,6	6	29	74	36	36	-4.6
	4,65	6	29	74	36	36	-4.65
	4,7	6	29	74	36	36	-4.7
	4,8	6	35	82	44	36	-4.8
	4,9	6	35	82	44	36	-4.9
	5	6	35	82	44	36	-5
	5,1	6	35	82	44	36	-5.1
	5,2	6	35	82	44	36	-5.2
	5,3	6	35	82	44	36	-5.3
	5,4	6	35	82	44	36	-5.4
	5,5	6	35	82	44	36	-5.5
	5,55	6	35	82	44	36	-5.55
	5,6	6	35	82	44	36	-5.6
	5,7	6	35	82	44	36	-5.7
	5,8	6	35	82	44	36	-5.8
	5,9	6	35	82	44	36	-5.9
	6	6	35	82	44	36	-6
	6,1	8	43	91	53	36	-6.1
	6,2	8	43	91	53	36	-6.2
	6,3	8	43	91	53	36	-6.3
	6,4	8	43	91	53	36	-6.4
	6,5	8	43	91	53	36	-6.5
	6,6	8	43	91	53	36	-6.6
	6,7	8	43	91	53	36	-6.7
	6,8	8	43	91	53	36	-6.8
	6,9	8	43	91	53	36	-6.9
	7	8	43	91	53	36	-7
	7,1	8	43	91	53	36	-7.1
	7,2	8	43	91	53	36	-7.2

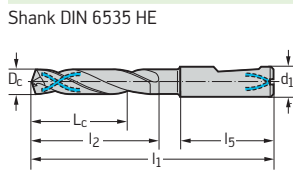

Continued



Solid carbide coolant through drills

A3999XPL

X-treme



5 x D_c

Continued

	P	M	K	N	S	H	O
XPL	●●	●●	●●	●●	●●	●●	●●

DIN 6537 long	D _c m7 mm	d ₁ h6 mm	L _c mm	l ₁ mm	l ₂ mm	l ₅ mm	Designation A3999XPL
Shank DIN 6535 HE	7,3	8	43	91	53	36	-7.3
	7,4	8	43	91	53	36	-7.4
	7,5	8	43	91	53	36	-7.5
	7,55	8	43	91	53	36	-7.55
	7,6	8	43	91	53	36	-7.6
	7,7	8	43	91	53	36	-7.7
	7,8	8	43	91	53	36	-7.8
	7,9	8	43	91	53	36	-7.9
	8	8	43	91	53	36	-8
	8,1	10	49	103	61	40	-8.1
	8,2	10	49	103	61	40	-8.2
	8,3	10	49	103	61	40	-8.3
	8,4	10	49	103	61	40	-8.4
	8,5	10	49	103	61	40	-8.5
	8,6	10	49	103	61	40	-8.6
	8,7	10	49	103	61	40	-8.7
	8,8	10	49	103	61	40	-8.8
	8,9	10	49	103	61	40	-8.9
	9	10	49	103	61	40	-9
	9,1	10	49	103	61	40	-9.1
	9,2	10	49	103	61	40	-9.2
	9,3	10	49	103	61	40	-9.3
	9,4	10	49	103	61	40	-9.4
	9,5	10	49	103	61	40	-9.5
	9,55	10	49	103	61	40	-9.55
	9,6	10	49	103	61	40	-9.6
	9,7	10	49	103	61	40	-9.7
	9,8	10	49	103	61	40	-9.8
	9,9	10	49	103	61	40	-9.9
	10	10	49	103	61	40	-10
	10,1	12	56	118	71	45	-10.1
	10,2	12	56	118	71	45	-10.2
	10,3	12	56	118	71	45	-10.3
	10,4	12	56	118	71	45	-10.4
	10,5	12	56	118	71	45	-10.5
	10,6	12	56	118	71	45	-10.6
	10,7	12	56	118	71	45	-10.7
	10,8	12	56	118	71	45	-10.8
	10,9	12	56	118	71	45	-10.9
	11	12	56	118	71	45	-11
	11,1	12	56	118	71	45	-11.1
	11,2	12	56	118	71	45	-11.2
	11,3	12	56	118	71	45	-11.3
	11,4	12	56	118	71	45	-11.4
	11,5	12	56	118	71	45	-11.5
	11,55	12	56	118	71	45	-11.55
	11,6	12	56	118	71	45	-11.6
	11,7	12	56	118	71	45	-11.7
	11,8	12	56	118	71	45	-11.8
	11,9	12	56	118	71	45	-11.9
	12	12	56	118	71	45	-12
	12,1	14	60	124	77	45	-12.1
	12,2	14	60	124	77	45	-12.2
	12,25	14	60	124	77	45	-12.25
	12,3	14	60	124	77	45	-12.3

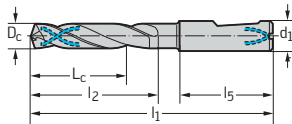

Continued

B-137

G-2

B-102

Solid carbide coolant through drills

A3999XPL

X-treme

 5 x D_c

Continued

	P	M	K	N	S	H	O
XPL	●●	●●	●●	●●	●●	●●	●●

DIN 6537 long	D _c m7 mm	d ₁ h6 mm	L _c mm	l ₁ mm	l ₂ mm	l ₅ mm	Designation A3999XPL
Shank DIN 6535 HE	12,4	14	60	124	77	45	-12.4
	12,5	14	60	124	77	45	-12.5
	12,6	14	60	124	77	45	-12.6
	12,7	14	60	124	77	45	-12.7
	12,75	14	60	124	77	45	-12.75
	12,8	14	60	124	77	45	-12.8
	12,9	14	60	124	77	45	-12.9
	13	14	60	124	77	45	-13
	13,1	14	60	124	77	45	-13.1
	13,2	14	60	124	77	45	-13.2
	13,3	14	60	124	77	45	-13.3
	13,4	14	60	124	77	45	-13.4
	13,5	14	60	124	77	45	-13.5
	13,6	14	60	124	77	45	-13.6
	13,7	14	60	124	77	45	-13.7
	13,8	14	60	124	77	45	-13.8
	13,9	14	60	124	77	45	-13.9
	14	14	60	124	77	45	-14
	14,1	16	63	133	83	48	-14.1
	14,2	16	63	133	83	48	-14.2
	14,3	16	63	133	83	48	-14.3
	14,4	16	63	133	83	48	-14.4
	14,5	16	63	133	83	48	-14.5
	14,6	16	63	133	83	48	-14.6
	14,7	16	63	133	83	48	-14.7
	14,75	16	63	133	83	48	-14.75
	14,8	16	63	133	83	48	-14.8
	14,9	16	63	133	83	48	-14.9
	15	16	63	133	83	48	-15
	15,1	16	63	133	83	48	-15.1
	15,2	16	63	133	83	48	-15.2
	15,3	16	63	133	83	48	-15.3
	15,4	16	63	133	83	48	-15.4
	15,5	16	63	133	83	48	-15.5
	15,6	16	63	133	83	48	-15.6
	15,7	16	63	133	83	48	-15.7
	15,8	16	63	133	83	48	-15.8
	15,9	16	63	133	83	48	-15.9
	16	16	63	133	83	48	-16
	16,1	18	71	143	93	48	-16.1
	16,2	18	71	143	93	48	-16.2
	16,3	18	71	143	93	48	-16.3
	16,4	18	71	143	93	48	-16.4
	16,5	18	71	143	93	48	-16.5
	16,6	18	71	143	93	48	-16.6
	16,7	18	71	143	93	48	-16.7
	16,75	18	71	143	93	48	-16.75
	16,8	18	71	143	93	48	-16.8
	16,9	18	71	143	93	48	-16.9
	17	18	71	143	93	48	-17
	17,1	18	71	143	93	48	-17.1
	17,2	18	71	143	93	48	-17.2
	17,3	18	71	143	93	48	-17.3
	17,4	18	71	143	93	48	-17.4
	17,5	18	71	143	93	48	-17.5

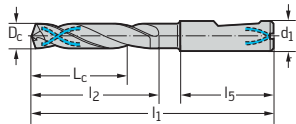

Continued



Solid carbide coolant through drills

A3999XPL

X-treme



5 x D_c

	P	M	K	N	S	H	O
XPL	●	●	●	●	●	●	●

Continued

DIN 6537 long	D _c m7 mm	d ₁ h6 mm	L _c mm	l ₁ mm	l ₂ mm	l ₅ mm	Designation A3999XPL
Shank DIN 6535 HE	17,6	18	71	143	93	48	-17.6
	17,7	18	71	143	93	48	-17.7
	17,8	18	71	143	93	48	-17.8
	17,9	18	71	143	93	48	-17.9
	18	18	71	143	93	48	-18
	18,1	20	77	153	101	50	-18.1
	18,2	20	77	153	101	50	-18.2
	18,3	20	77	153	101	50	-18.3
	18,4	20	77	153	101	50	-18.4
	18,5	20	77	153	101	50	-18.5
	18,6	20	77	153	101	50	-18.6
	18,7	20	77	153	101	50	-18.7
	18,8	20	77	153	101	50	-18.8
	18,9	20	77	153	101	50	-18.9
	19	20	77	153	101	50	-19
	19,1	20	77	153	101	50	-19.1
	19,2	20	77	153	101	50	-19.2
	19,3	20	77	153	101	50	-19.3
	19,4	20	77	153	101	50	-19.4
	19,5	20	77	153	101	50	-19.5
	19,6	20	77	153	101	50	-19.6
	19,7	20	77	153	101	50	-19.7
	19,8	20	77	153	101	50	-19.8
	19,9	20	77	153	101	50	-19.9
	20	20	77	153	101	50	-20
	20,5	25	86	166	108	56	-20.5
	21	25	86	166	108	56	-21
	21,5	25	86	166	108	56	-21.5
	22	25	86	166	108	56	-22
	22,5	25	91	173	115	56	-22.5
	23	25	91	173	115	56	-23
	23,5	25	91	173	115	56	-23.5
	24	25	91	173	115	56	-24
	24,5	25	97	180	122	56	-24.5
	25	25	97	180	122	56	-25

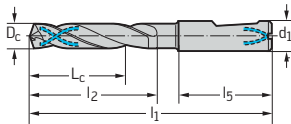

Solid carbide Micro-Pilot drill A6181AML

X-treme Pilot 150



2 x D_c

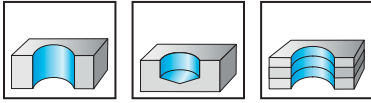

- K30F - AML
- Type X-treme Pilot 150
- Right-hand cutting
- 150° point angle
- Special diameter tolerance for micro XD technology

	P	M	K	N	S	H	O
AML	●●	●●	●●	●●	●●	●●	●●

	D _c p7 mm	D _c Inches/No	d ₁ h6 mm	L _c mm	l ₁ mm	l ₂ mm	l ₅ mm	Designation A6181AML
Shank DIN 6535 HA	2		3	7	57	10	42	-2
	2,05		3	7	57	11	42	★ -2.05
	2,1		3	7	57	11	42	-2.1
	2,15		3	7	57	11	42	★ -2.15
	2,2		3	7	57	11	42	-2.2
	2,25		3	8	57	12	42	★ -2.25
	2,3		3	8	59	12	43	-2.3
	2,35		3	8	59	12	42	★ -2.35
	2,381	3/32"	3	8	59	12	43	★ -3/32IN
	2,4		3	8	59	12	43	-2.4
	2,45		3	9	59	13	43	★ -2.45
	2,5		3	9	59	13	42	-2.5
	2,55		3	9	62	13	42	★ -2.55
	2,6		3	9	62	13	45	-2.6
	2,65		3	9	62	14	45	★ -2.65
	2,7		3	9	62	14	45	-2.7
	2,75		3	9	62	14	45	★ -2.75
	2,778	7/64"	3	9	62	14	45	★ -7/64IN
	2,8		3	9	62	14	45	-2.8
	2,85		3	10	62	15	45	★ -2.85
	2,9		3	10	62	15	44	-2.9
	2,95		3	10	62	15	44	★ -2.95

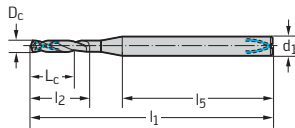

★ New addition to range



Solid carbide coolant through drill Micro A6489AMP X-treme DM8



8 x D_c

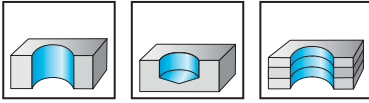

- K30F - AMP
- Type X-treme DM8
- Right-hand cutting
- 140° point angle

	P	M	K	N	S	H	O
AMP	●●	●●	●●	●●	●●	●	●●

	D _c m7 mm	D _c Inches/No	d ₁ h6 mm	L _c mm	l ₁ mm	l ₂ mm	l ₅ mm	Designation A6489AMP
Shank DIN 6535 HA	2		3	20	63	23	35	★ -2
	2,05		3	20	63	24	35	★ -2.05
	2,1		3	20	63	24	35	★ -2.1
	2,15		3	21	63	25	34	★ -2.15
	2,2		3	21	63	25	34	★ -2.2
	2,25		3	22	67	26	37	★ -2.25
	2,3		3	22	67	26	37	★ -2.3
	2,35		3	24	67	28	35	★ -2.35
	2,381	3/32"	3	24	67	28	35	★ -3/32IN
	2,4		3	24	67	28	35	★ -2.4
	2,45		3	25	67	29	34	★ -2.45
	2,5		3	25	67	29	34	★ -2.5
	2,55		3	26	71	30	37	★ -2.55
	2,6		3	26	71	30	37	★ -2.6
	2,65		3	26	71	31	37	★ -2.65
	2,7		3	26	71	31	37	★ -2.7
	2,75		3	27	71	32	36	★ -2.75
	2,778	7/64"	3	27	71	32	36	★ -7/64IN
	2,8		3	27	71	32	36	★ -2.8
	2,85		3	28	71	33	35	★ -2.85
	2,9		3	28	71	33	35	★ -2.9
	2,95		3	29	71	34	34	★ -2.95

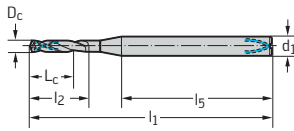

★ New addition to range



Solid carbide coolant through drill Micro A6589AMP X-treme DM12



12 x D_c

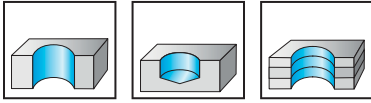

- K30F - AMP
- Type X-treme DM12
- Right-hand cutting
- 140° point angle

	P	M	K	N	S	H	O
AMP	●●	●●	●●	●●	●●	●	●●

	D _c h7 mm	D _c Inches/No	d ₁ h6 mm	L _c mm	l ₁ mm	l ₂ mm	l ₅ mm	Designation A6589AMP
Shank DIN 6535 HA	2		3	28	72	31	36	★ -2
	2,1		3	29	72	33	35	★ -2.1
	2,2		3	30	72	34	34	★ -2.2
	2,3		3	32	77	36	37	★ -2.3
	2,381	3/32"	3	33	77	37	36	★ -3/32IN
	2,4		3	33	77	37	36	★ -2.4
	2,5		3	35	77	39	34	★ -2.5
	2,6		3	36	83	40	39	★ -2.6
	2,7		3	37	83	42	38	★ -2.7
	2,778	7/64"	3	38	83	43	37	★ -7/64IN
	2,8		3	38	83	43	37	★ -2.8
	2,9		3	40	83	45	35	★ -2.9

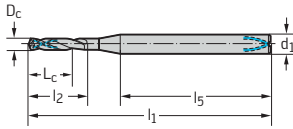

★ New addition to range



Solid carbide coolant through drill Micro A6689AMP X-treme DM16



16 x D_c

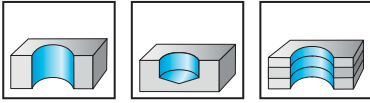

- K30F - AMP
- Type X-treme DM16
- Right-hand cutting
- 140° point angle

	P	M	K	N	S	H	O
AMP	●●	●●	●●	●●	●●	●	●●

	D _c h7 mm	D _c Inches/No	d ₁ h6 mm	L _c mm	l ₁ mm	l ₅ mm	Designation A6689AMP
Shank DIN 6535 HA	2		3	36	81	37	★ -2
	2,1		3	37	81	36	★ -2.1
	2,2		3	39	81	34	★ -2.2
	2,3		3	39	87	38	★ -2.3
	2,381	3/32"	3	43	87	36	★ -3/32IN
	2,4		3	43	87	36	★ -2.4
	2,5		3	45	87	34	★ -2.5
	2,6		3	47	95	40	★ -2.6
	2,7		3	48	95	39	★ -2.7
	2,778	7/64"	3	50	95	37	★ -7/64IN
	2,8		3	50	95	37	★ -2.8
	2,9		3	52	95	35	★ -2.9

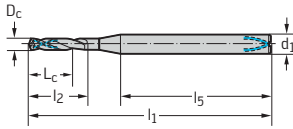

★ New addition to range



Solid carbide coolant through drill Micro A6789AMP X-treme DM20



20 x D_c

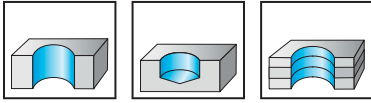

- K30F - AMP
- Type X-treme DM20
- Right-hand cutting
- 140° point angle

	P	M	K	N	S	H	O
AMP	●	●	●	●	●	●	●

	D _c h7 mm	D _c Inches/No	d ₁ h6 mm	L _c mm	l ₁ mm	l ₂ mm	l ₅ mm	Designation A6789AMP
Shank DIN 6535 HA	2		3	44	90	47	38	-2
	2,1		3	45	90	49	37	-2.1
	2,2		3	48	90	52	34	-2.2
	2,3		3	50	97	54	39	-2.3
	2,381	3/32"	3	52	97	56	39	★ -3/32IN
	2,4		3	52	97	56	37	-2.4
	2,5		3	55	97	59	34	-2.5
	2,6		3	57	107	61	42	-2.6
	2,7		3	58	107	63	41	-2.7
	2,778	7/64"	3	61	107	66	41	★ -7/64IN
	2,8		3	61	107	66	38	-2.8
	2,9		3	63	107	68	36	-2.9

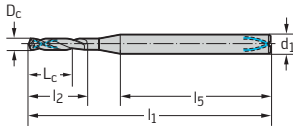

★ New addition to range



Solid carbide coolant through drill Micro A6889AMP X-treme DM25



25 x D_c

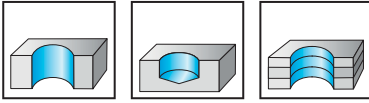

- K30F - AMP
- Type X-treme DM25
- Right-hand cutting
- 140° point angle

	P	M	K	N	S	H	O
AMP	●	●	●	●	●	●	●

	D _c h7 mm	D _c Inches/No	d ₁ h6 mm	L _c mm	l ₁ mm	l ₂ mm	l ₅ mm	Designation A6889AMP
Shank DIN 6535 HA	2		3	54	101	57	39	★ -2
	2,1		3	56	101	60	37	★ -2.1
	2,2		3	59	101	63	34	★ -2.2
	2,3		3	62	107	66	39	★ -2.3
	2,381	3/32"	3	62	107	66	39	★ -3/32IN
	2,4		3	64	107	68	35	★ -2.4
	2,5		3	67	107	71	32	-2.5
	2,6		3	70	122	74	44	-2.6
	2,7		3	72	122	77	41	-2.7
	2,778	7/64"	3	75	122	80	41	★ -7/64IN
	2,8		3	75	122	80	38	-2.8
	2,9		3	78	122	83	36	-2.9

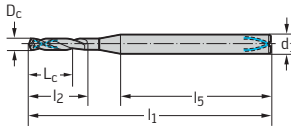

★ New addition to range



Solid carbide coolant through drill Micro A6989AMP

X-treme DM30



30 x D_c

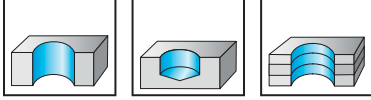

- K30F - AMP
- Type X-treme DM30
- Right-hand cutting
- 140° point angle

	P	M	K	N	S	H	O
AMP	●●	●●	●●	●●	●●	●	●●

	D _c h7 mm	D _c Inches/No	d ₁ h6 mm	L _c mm	l ₁ mm	l ₂ mm	l ₅ mm	Designation A6989AMP
Shank DIN 6535 HA	2		3	64	112	67	40	★ -2
	2,1		3	66	112	70	38	★ -2.1
	2,2		3	70	112	74	34	★ -2.2
	2,3		3	73	122	77	41	★ -2.3
	2,381	3/32"	3	76	122	80	38	★ -3/32IN
	2,4		3	76	122	80	38	★ -2.4
	2,5		3	80	122	84	34	★ -2.5
	2,6		3	83	136	87	45	★ -2.6
	2,7		3	85	136	90	42	★ -2.7
	2,778	7/64"	3	89	136	94	38	★ -7/64IN
	2,8		3	89	136	94	38	★ -2.8
	2,9		3	92	136	97	36	★ -2.9

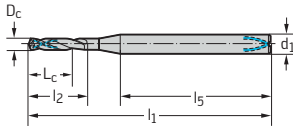

★ New addition to range



Solid carbide coolant through drills

A7495TTP X-treme D40 40 x D_c

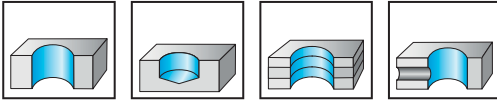

- K30F - TTP
- Type X-treme D40
- Right-hand cutting
- 130° point angle

	P	M	K	N	S	H	O
TTP	●●	●	●●	●●	●		

	D _c e7 mm	D _c Inches/No	d ₁ h6 mm	L _c mm	l ₁ mm	l ₂ mm	l ₅ mm	Designation A7495TTP
<p>Shank DIN 6535 HA</p>	4,5		5	188	228	195	28	★ -4.5
	4,736	3/16"	5	209	249	217	28	★ -3/16IN
	4,8		5	209	249	217	28	★ -4.8
	5		5	209	249	217	28	★ -5
	5,5		6	230	279	239	36	★ -5.5
	5,556	7/32"	6	248	297	257	36	★ -7/32IN
	5,8		6	248	297	257	36	★ -5.8
	6		6	248	297	257	36	★ -6
	6,1		8	272	324	282	36	★ -6.1
	6,35	1/4"	8	272	324	282	36	★ -1/4IN
	6,5		8	272	324	282	36	★ -6.5
	6,8		8	287	339	298	36	★ -6.8
	7		8	287	339	298	36	★ -7
	7,144	9/32"	8	313	366	325	36	★ -9/32IN
	7,4		8	313	366	325	36	★ -7.4
	7,5		8	313	366	325	36	★ -7.5
	7,938	5/16"	8	330	382	342	36	★ -5/16IN
	8		8	330	382	342	36	★ -8
	8,3		10	356	415	369	40	★ -8.3
	8,5		10	356	415	369	40	★ -8.5
8,731	11/32"	10	371	430	385	40	★ -11/32IN	
9		10	371	430	385	40	★ -9	
9,525	3/8"	10	397	457	412	40	★ -3/8IN	
9,8		10	418	477	433	40	★ -9.8	
10		10	418	477	433	40	★ -10	
10,2		12	460	528	477	45	★ -10.2	
10,319	13/32"	12	460	528	477	45	★ -13/32IN	
11		12	460	528	477	45	★ -11	

★ New addition to range



Solid carbide coolant through chamfer pilot drill

K3281TFT

X-treme Pilot Step 90



2 x D_c

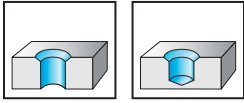

- K30F - TFT
- Type X-treme Pilot Step 90
- Right-hand cutting
- 150° point angle
- 90° countersink angle
- Special diameter tolerance for XD technology

	P	M	K	N	S	H	O
unbeschichtet	●	●	●	●	●	●	●

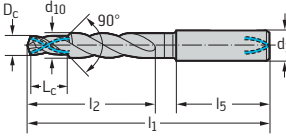
	D _c p7 mm	D _c Inches/No	d ₁ h6 mm	d ₁₀ h8 mm	L _c mm	l ₁ mm	l ₂ mm	l ₅ mm	Designation K3281TFT
Shank DIN 6535 HA 	3		6	6	6	66	20	36	★ -3
	3,175	1/8"	6	6	7,6	66	20	36	★ -1/8IN
	3,5		6	6	7,6	66	20	36	★ -3.5
	3,571	9/64"	6	6	7,6	66	20	36	★ -9/64IN
	3,967	5/32"	6	6	9,6	66	22	36	★ -5/32IN
	4		6	6	9,6	66	22	36	★ -4
	4,5		6	6	9,6	66	22	36	★ -4.5
	4,763	3/16"	8	8	12	79	28	36	★ -3/16IN
	4,8		8	8	12	79	28	36	★ -4.8
	5		8	8	12	79	28	36	★ -5
	5,5		8	8	12	79	28	36	★ -5.5
	5,558	7/32"	8	8	12	79	28	36	★ -7/32IN
	5,8		8	8	12	79	28	36	★ -5.8
	6		8	8	12	79	28	36	★ -6
	6,1		10	10	14	89	34	40	★ -6.1
	6,35	1/4"	10	10	14	89	34	40	★ -1/4IN
	6,5		10	10	14	89	34	40	★ -6.5
	6,8		10	10	14	89	34	40	★ -6.8
	7		10	10	14	89	34	40	★ -7
	7,142	9/32"	12	12	16	102	40	45	★ -9/32IN
	7,4		12	12	16	102	40	45	★ -7.4
	7,5		12	12	16	102	40	45	★ -7.5
	7,938	5/16"	12	12	16	102	40	45	★ -5/16IN
	8		12	12	16	102	40	45	★ -8
	8,3		12	12	20	102	44	45	★ -8.3
	8,5		12	12	20	102	44	45	★ -8.5
	8,733	11/32"	12	12	20	102	44	45	★ -11/32IN
	9		12	12	20	102	44	45	★ -9
	9,525	3/8"	12	12	20	102	44	45	★ -3/8IN
	9,8		12	12	20	102	44	45	★ -9.8
	10		12	12	20	102	44	45	★ -10
	10,2		14	14	24	107	52	45	★ -10.2
	10,317	13/32"	14	14	24	107	52	45	★ -13/32IN
11		14	14	24	107	52	45	★ -11	
11,113	7/16"	14	14	24	107	52	45	★ -7/16IN	
11,5		14	14	24	107	52	45	★ -11.5	
11,8		14	14	24	107	52	45	★ -11.8	
11,908	15/32"	14	14	24	107	52	45	★ -15/32IN	
12		14	14	24	107	52	45	★ -12	
12,7	1/2"	16	16	28	115	58	48	★ -1/2IN	
13		16	16	28	115	58	48	★ -13	
14		16	16	28	115	58	48	★ -14	
14,288	9/16"	18	18	32	123	66	48	★ -9/16IN	
15		18	18	32	123	66	48	★ -15	
16		18	18	32	123	66	48	★ -16	

★ New addition to range





Solid carbide coolant through chamfer drill

K3299XPL

X-treme Step 90

3 x D_c

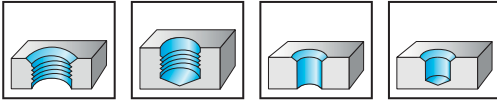

- K30F - XPL
- Type X-treme cutting
- Right-hand cutting
- 140° point angle
- 90° countersink angle
- Step length in accordance with DIN 8378

	P	M	K	N	S	H	O
XPL	●●	●●	●●	●●	●●	●●	

	for thread	D _c m7 mm	d ₁ h6 mm	d ₁₀ h8 mm	L _c mm	l ₁ mm	l ₂ mm	l ₅ mm	Designation K3299XPL
Shank DIN 6535 HA									
	M 4	3,3	6	5	11,4	66	28	36	★ -M4
	M 5	4,2	6	6	13,6	66	28	36	★ -M5
	M 6	5	8	8	16,5	79	41	36	★ -M6
	M 8	6,8	10	10	21	89	47	40	★ -M8
	M 10	8,5	12	12	25,5	102	55	45	★ -M10
	M 12	10,2	14	14	30	107	60	45	★ -M12
	M 14	12	16	16	34,5	115	65	48	★ -M14
	M 16	14	18	18	38,5	123	73	48	★ -M16

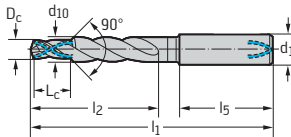

★ New addition to range



Solid carbide chamfer drill

K3879XPL

X-treme Step 90



3 x D_c

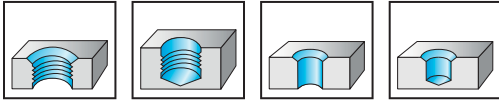

- K30F - XPL
- Type X-treme cutting
- Right-hand cutting
- 140° point angle
- 90° countersink angle
- Step length in accordance with DIN 8378

	P	M	K	N	S	H	O
XPL	●●	●●	●●	●●	●●	●●	●●

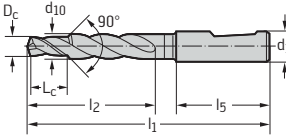
	for thread	D _c m7 mm	d ₁ h6 mm	d ₁₀ h8 mm	L _c mm	l ₁ mm	l ₂ mm	l ₅ mm	Designation K3879XPL
Shank DIN 6535 HE 	M 4	3,3	6	5	11,4	66	28	36	★ -M4
	M 5	4,2	6	6	13,6	66	28	36	★ -M5
	M 6	5	8	8	16,5	79	41	36	★ -M6
	M 8	6,8	10	10	21	89	47	40	★ -M8
	M 8 x 1	7	10	10	21	89	47	40	★ -M8X1
	M 10	8,5	12	12	25,5	102	55	45	★ -M10
	M 10 x 1	9	12	12	25,5	102	55	45	★ -M10X1
	M 12	10,2	14	14	30	107	60	45	★ -M12
	M 12 x 1,5	10,5	14	14	30	107	60	45	★ -M12X1.5
	M 14	12	16	16	34,5	115	65	48	★ -M14
	M 14 x 1,5	12,5	16	16	34,5	115	65	48	★ -M14X1.5
	M 16	14	18	18	38,5	123	73	48	★ -M16
	M 16 x 1,5	14,5	18	18	38,5	123	73	48	★ -M16X1.5

★ New addition to range



Solid carbide coolant through - chamfer drill K3899XPL X-treme Step 90



3 x D_c

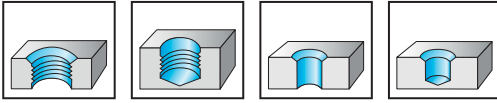

- K30F - XPL
- Type X-treme cutting
- Right-hand cutting
- 140° point angle
- 90° countersink angle
- Step length in accordance with DIN 8378

	P	M	K	N	S	H	O
XPL	●●	●●	●●	●●	●●	●●	

	for thread	D _c m7 mm	d ₁ h6 mm	d ₁₀ h8 mm	L _c mm	l ₁ mm	l ₂ mm	l ₅ mm	Designation K3899XPL
	M 4	3,3	6	5	11,4	66	28	36	★ -M4
	M 5	4,2	6	6	13,6	66	28	36	★ -M5
	M 6	5	8	8	16,5	79	41	36	★ -M6
	M 8	6,8	10	10	21	89	47	40	★ -M8
	M 10	8,5	12	12	25,5	102	55	45	★ -M10
	M 12	10,2	14	14	30	107	60	45	★ -M12
	M 14	12	16	16	34,5	115	65	48	★ -M14
M 16	14	18	18	38,5	123	73	48	★ -M16	

★ New addition to range



Walter Select for HSS core drilling, countersinking and centre drills

Step by step to the correct tool

STEP 1

Determine the **material** to be machined from page H 8 in the Walter General catalogue 2012.

Note the **machining group** that corresponds to your material e.g.: K5.

Code letter	Machining group	Groups of the materials to be machined	
P	P1–P15	Steel	All types of steel and cast steel, with the exception of steel with an austenitic structure
M	M1–M3	Stainless steel	Stainless austenitic steel and austenitic-ferritic steel and cast steel
K	K1–K7	Cast iron	Grey cast iron, cast iron with spheroidal graphite, malleable cast iron, cast iron with vermicular graphite
N	N1–N10	NF metals	Aluminium and other non-ferrous metals, non-ferrous materials
S	S1–S10	High temperature alloys and titanium alloys	Heat resisting special alloys based on iron, nickel and cobalt, titanium and titanium alloys
H	H1–H4	Hard materials	Hardened steel, hardened cast iron materials, chilled cast iron
O	O1–O6	Other	Plastics, glass and carbon fibre Reinforced plastics, graphite

STEP 2

Select the **machining conditions**:

Machine stability, clamping system and workpiece		
very good	good	moderate
😊	😐	😞

STEP 3

Select your tool from the table from page B-80:

- In acc. with **DIN and form** (e.g. DIN 345, form C; Form A)
- In acc. with the **machining conditions** (see step 2: 😊 😐 😞)
- For the relevant **machining group** (see step 1: P1-P15; M1-M3; ... O1-O6)

Machine stability, clamping system and workpiece

very good good moderate

Main application

Additional application

Material group		Workpiece material		Dimensions		DIN 333	
				Designation	Form	⊙	⊙
		Grouping of main material groups and code letters					
		Workpiece material		Binell hardness HB	Tensile strength R _m N/mm ²	Machining group	
P	Non-alloyed and low-alloyed steel	annealed (tempered)	210	700	P1, P2, P3, P4, P7	●	●●
		machining steel	220	750	P6	●	●●
		tempered	300	1010	P5, P8	●●	●●
		tempered	380	1280	P9	●●	●●
		tempered	430	1480	P10	●●	●●
	High-alloyed steel and high-alloyed tool steel	annealed	200	670	P11	●	●●
		hardened and tempered	300	1010	P12	●●	●●
		hardened and tempered	400	1360	P13	●●	●●
	Stainless steel	ferritic/martensitic, annealed	200	670	P14	●	●●
		martensitic, tempered	330	1110	P15	●●	●●
M	Stainless steel	austenitic, duplex	230	780		●●	
		austenitic, precipitation hardened (PH)					

STEP 4

Choose your **cutting data** from the table from page B-114 onwards:

- **Cutting speed:** v_c
- **Feed:** VRR (feed rating chart)

Go to the row of your machining group (e.g. K5) and the column of your selected tool. You will find the cutting speed v_c and the VRR there.

The feed rating chart (VRR) can be found from page B-124 onwards.

☞ = Cutting data for wet machining

☞☞ = Dry machining is possible, cutting data must be selected from Walter GPS

E = Emulsion

⊙ = Oil

M = MOL

L = Dry

v_c = Cutting speed

VRR = v_c rating chart from page B-122

VRR = Feed rating chart from page B-124



Material group		Workpiece material		Dimensions		DIN 333										
				Designation	Form	⊙	⊙									
		Structure of main material groups and code letters														
		Workpiece material		Binell hardness HB	Tensile strength R _m N/mm ²	Machining group ¹⁾										
P	Non-alloyed steel	C ≤ 0.25%	annealed	125	428	P1	48	6	EO	M	L	72	6	EO	M	L
		C > 0.25% ≤ 0.55%	annealed	190	639	P2	45	6	EO	M	L	68	6	EO	M	L
		C > 0.25% ≤ 0.55%	tempered	210	708	P3	42	6	EO	M	L	63	6	EO	M	L
		C > 0.55%	annealed	190	639	P4	45	6	EO	M	L	68	6	EO	M	L
		C > 0.55%	tempered	300	1013	P5	32	5	EO	M	L	48	5	EO	M	L
	Low-alloyed steel	machining steel (short-chipping)	annealed	220	745	P6	48	6	EO	M	L	72	6	EO	M	L
		annealed	175	591	P7	45	6	EO	M	L	68	6	EO	M	L	
		tempered	300	1013	P8	32	5	EO	M	L	48	5	EO	M	L	
		tempered	380	1282	P9	21	3	EO	M	L	32	3	EO	M	L	
		tempered	430	1477	P10	16	2	EO	M	L	24	2	EO	M	L	
High-alloyed steel and high-alloyed tool steel	annealed	200	675	P11	28	4	EO	M	L	42	4	EO	M	L		
	hardened and tempered	300	1013	P12	25	4	EO	M	L	38	4	EO	M	L		
	hardened and tempered	400	1361	P13	16	2	EO	M	L	24	2	EO	M	L		
Stainless steel	ferritic/martensitic, annealed	200	675	P14	28	4	EO	M	L	42	4	EO	M	L		
	martensitic, tempered	330	1114	P15	21	3	EO	M	L	32	3	EO	M	L		
M	Stainless steel	austenitic, quench hardened	200	675	M1											
		austenitic, precipitation hardened (PH)	300	1013	M2	21	3	EO	M	L	21	3	EO	M	L	
	Malleable cast iron	austenitic-ferritic, duplex	230	778	M3											

Walter Select – Centring

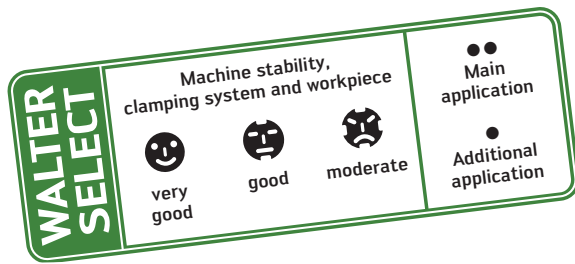
Solid carbide and HSS centre drills



Dimensions	DIN 333	
Machining conditions	☺	☺
Designation	K1161	K1161XPL
Form	A	A
Type	–	–
Ø range (mm)	0,50 – 6,30	0,50 – 6,30
Cutting tool material	K10/20	K10/20
Coating	uncoated	XPL
Page	B-84	B-85

Material group	Grouping of main material groups and code letters		Brinell hardness HB	Tensile strength R _m N/mm ²	Machining group		
	Workpiece material						
P	Non-alloyed and low-alloyed steel	annealed (tempered)	210	700	P1, P2, P3, P4, P7	●	●●
		machining steel	220	750	P6	●	●●
		tempered	300	1010	P5, P8	●●	●●
		tempered	380	1280	P9	●●	●●
		tempered	430	1480	P10	●●	●●
	High-alloyed steel and high-alloyed tool steel	annealed	200	670	P11	●	●●
hardened and tempered		300	1010	P12	●●	●●	
hardened and tempered		400	1360	P13	●●	●●	
Stainless steel	ferritic/martensitic, annealed	200	670	P14	●	●●	
	martensitic, tempered	330	1110	P15	●●	●●	
M	Stainless steel	austenitic, duplex	230	780	M1, M3	●●	●●
		austenitic, precipitation hardened (PH)	300	1010	M2	●●	●●
K	Grey cast iron		245	–	K3, K4	●●	●●
	Cast iron with spheroidal graphite	ferritic, pearlitic	365	–	K1, K2, K5, K6	●●	●●
	GGV (CGI)		200	–	K7	●●	●●
N	Aluminium wrought alloys	cannot be hardened	30	–	N1	●●	●●
		hardenable, hardened	100	340	N2	●●	●●
	Cast aluminium alloys	≤ 12% Si	90	310	N3, N4	●●	●●
		> 12% Si	130	450	N5	●●	●●
	Magnesium alloys		70	250	N6	●●	●●
	Copper and copper alloys (bronze/brass)	non-alloyed, electrolytic copper		100	340	N7	●●
brass, bronze, red brass			90	310	N8	●●	●●
Cu-alloys, short-chipping			110	380	N9	●●	●●
high-strength, Ampco			300	1010	N10	●●	●●
S	Heat-resistant alloys	Fe-based	280	940	S1, S2	●●	●●
		Ni or Co base	250	840	S3	●●	●●
		Ni or Co base	350	1080	S4, S5	●●	●●
	Titanium alloys	pure titanium	200	670	S6		
		α and β alloys, hardened	375	1260	S7		
		β alloys	410	1400	S8		
Tungsten alloys		300	1010	S9	●●	●●	
Molybdenum alloys		300	1010	S10	●●	●●	
H	Hardened steel		50 HRC	–	H1	●	●●
			55 HRC	–	H2, H4		
			60 HRC	–	H3		
O	Thermoplasts	without abrasive fillers			O1	●●	●●
	Thermosetting plastics	without abrasive fillers			O2	●●	●●
	Plastic, fibre-reinforced	GFRP, AFRP			O3, O5	●●	●●
		CFRP			O4	●●	●●
Graphite (technical)			65		O6	●●	●●

* The pages indicated in italics refer to the Walter General catalogue 2012.

DIN 333								
K1111TIN	K1111	K1112	K1113	K1113TIN	K1113	K1114	K1114	K1215
A	A	A	A	R	R	R	R	B
-	-	with flat	left-hand	-	-	with flat	-	-
1,00 – 5,00	0,50 – 12,50	1,60 – 5,00	0,50 – 6,30	1,00 – 5,00	0,50 – 12,50	1,60 – 5,00	1,60 – 5,00	1,00 – 10,00
HSS	HSS	HSS	HSS	HSS	HSS	HSS	HSS	HSS
TiN	uncoated	uncoated	uncoated	TiN	uncoated	uncoated	uncoated	uncoated
B 292*	B 292*	B 293*	B 297*	B 295*	B 294*	B 296*	B 296*	B 299*
••	••	••	••	••	••	••	••	••
••	••	••	••	••	••	••	••	••
••	•	•	•	••	•	•	•	•
•	•	•	•	•	•	•	•	•
••	••	••	••	••	••	••	••	••
••	•	•	•	••	•	•	•	•
••	••	••	••	••	••	••	••	••
•	•	•	•	•	•	•	•	•
••	••	••	••	••	••	••	••	••
••	••	••	••	••	••	••	••	••
•	•	•	•	•	•	•	•	•
••	••	••	••	••	••	••	••	••
••	••	••	••	••	••	••	••	••
••	••	••	••	••	••	••	••	••
••	••	••	••	••	••	••	••	••
••	••	••	••	••	••	••	••	••
••	••	••	••	••	••	••	••	••
•	•	•	•	•	•	•	•	•
••	••	••	••	••	••	••	••	••
•	•	•	•	•	•	•	•	•
••	••	••	••	••	••	••	••	••
•	•	•	•	•	•	•	•	•
•	•	•	•	•	•	•	•	•
••	••	••	••	••	••	••	••	••
••	••	••	••	••	••	••	••	••

Walter Select – Centring Solid carbide and HSS centre drills

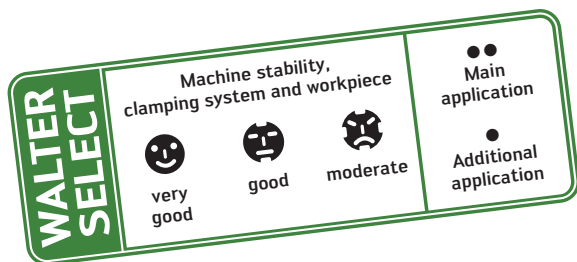

Dimensions	Walter standard	
	Machining conditions	
Designation	K1313	K1311
Form	R	A
Type	–	–
Ø range (mm)	1,00 – 4,00	0,63 – 6,00
Cutting tool material	HSS	HSS
Coating	uncoated	uncoated
Page	<i>B 301*</i>	<i>B 300*</i>

Material group	Grouping of main material groups and code letters Workpiece material	Brinell hardness HB	Tensile strength R _m N/mm ²	Machining group				
P	Non-alloyed and low-alloyed steel	annealed (tempered)	210	700	P1, P2, P3, P4, P7	●●	●●	
		machining steel	220	750	P6	●●	●●	
		tempered	300	1010	P5, P8	●	●	
		tempered	380	1280	P9	●	●	
		tempered	430	1480	P10	●	●	
	High-alloyed steel and high-alloyed tool steel	annealed	200	670	P11	●●	●●	
hardened and tempered		300	1010	P12	●	●		
hardened and tempered		400	1360	P13	●	●		
Stainless steel	ferritic/martensitic, annealed	200	670	P14	●●	●●		
	martensitic, tempered	330	1110	P15	●	●		
M	Stainless steel	austenitic, duplex	230	780	M1, M3	●●	●●	
		austenitic, precipitation hardened (PH)	300	1010	M2	●	●	
K	Grey cast iron	245	–	K3, K4	●●	●●		
	Cast iron with spheroidal graphite	365	–	K1, K2, K5, K6	●●	●●		
	GGV (CGI)	200	–	K7	●●	●●		
N	Aluminium wrought alloys	cannot be hardened	30	–	N1	●●	●●	
		hardenable, hardened	100	340	N2	●●	●●	
	Cast aluminium alloys	≤ 12% Si	90	310	N3, N4	●●	●●	
		> 12% Si	130	450	N5	●	●	
	Magnesium alloys	70	250	N6	●●	●●		
	Copper and copper alloys (bronze/brass)	non-alloyed, electrolytic copper	100	340	N7	●●	●●	
brass, bronze, red brass		90	310	N8	●●	●●		
Cu-alloys, short-chipping		110	380	N9	●●	●●		
high-strength, Ampco		300	1010	N10	●	●		
S	Heat-resistant alloys	Fe-based	280	940	S1, S2	●●	●●	
		Ni or Co base	250	840	S3	●●	●●	
		Ni or Co base	350	1080	S4, S5	●	●	
	Titanium alloys	pure titanium	200	670	S6	●●	●●	
		α and β alloys, hardened	375	1260	S7	●	●	
		β alloys	410	1400	S8	●	●	
Tungsten alloys	300	1010	S9	●	●			
Molybdenum alloys	300	1010	S10	●	●			
H	Hardened steel	50 HRC	–	H1				
		55 HRC	–	H2, H4				
		60 HRC	–	H3				
O	Thermoplasts	without abrasive fillers			O1	●●	●●	
	Thermosetting plastics	without abrasive fillers			O2	●●	●●	
	Plastic, fibre-reinforced	GFRP, AFRP				O3, O5		
		CFRP				O4		
Graphite (technical)		65		O6				

* The pages indicated in italics refer to the Walter General catalogue 2012.

	Walter standard			ANSI B 94.11 M-1979	B.S. 328	Step centre drill	
	K1411S	K1411M	K1411L	K1811	K1911	K2511	K2513
	A	A	A	A	A	60°	Radius
	-	-	-	-	-	-	-
	0,75 - 5,00	0,75 - 4,00	2,00 - 4,00	0,64 - 7,97	1,19 - 7,94	3,30 - 21,00	3,30 - 21,00
	HSS	HSS	HSS	HSS	HSS	HSS	HSS
	uncoated	uncoated	uncoated	uncoated	uncoated	uncoated	uncoated
	B 304*	B 303*	B 302*	B 305*	B 306*	B 307*	B 308*
	••	••	••	••	••	••	••
	••	••	••	••	••	••	••
	•	•	•	•	•	•	•
	•	•	•	•	•	•	•
	••	••	••	••	••	••	••
	•	•	•	•	•	•	•
	••	••	••	••	••	••	••
	•	•	•	•	•	•	•
	••	••	••	••	••	••	••
	•	•	•	•	•	•	•
	••	••	••	••	••	••	••
	•	•	•	•	•	•	•
	••	••	••	••	••	••	••
	•	•	•	•	•	•	•
	••	••	••	••	••	••	••
	•	•	•	•	•	•	•
	••	••	••	••	••	••	••
	•	•	•	•	•	•	•
	••	••	••	••	••	••	••
	•	•	•	•	•	•	•
	••	••	••	••	••	••	••
	•	•	•	•	•	•	•
	••	••	••	••	••	••	••
	•	•	•	•	•	•	•
	••	••	••	••	••	••	••
	•	•	•	•	•	•	•
	••	••	••	••	••	••	••
	•	•	•	•	•	•	•
	••	••	••	••	••	••	••
	•	•	•	•	•	•	•
	••	••	••	••	••	••	••
	•	•	•	•	•	•	•
	••	••	••	••	••	••	••
	•	•	•	•	•	•	•
	••	••	••	••	••	••	••
	•	•	•	•	•	•	•
	••	••	••	••	••	••	••
	•	•	•	•	•	•	•
	••	••	••	••	••	••	••
	•	•	•	•	•	•	•
	••	••	••	••	••	••	••
	•	•	•	•	•	•	•
	••	••	••	••	••	••	••
	•	•	•	•	•	•	•
	••	••	••	••	••	••	••
	•	•	•	•	•	•	•

**Solid carbide centre drill
K1161
Form A**

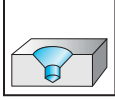

- K10/20 - uncoated
- Form A
- Right-hand cutting
- For centring 60° without protective countersink
- For straight contact surfaces in acc. with DIN 332 A

	P	M	K	N	S	H	O
uncoated	●●	●●	●●	●●	●●	●	●●

DIN 333	D _c k12 mm	d ₁ h9 mm	l ₁ mm	Designation K1161
Cylindrical shank	0,5	3,15	25	-0.5
	0,8	3,15	25	-0.8
	1	3,15	32	-1
	1,25	3,15	32	-1.25
	1,6	4	36	-1.6
	2	5	40	-2
	2,5	6,3	45	-2.5
	3,15	8	50	-3.15
	4	10	56	-4
	5	12,5	63	-5
	6,3	16	71	-6.3

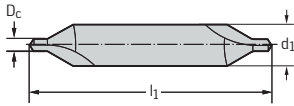

D_c 0.5/0.8 single-sided

Solid carbide centre drill K1161XPL Form A

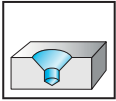

- K10/20 - XPL
- Form A
- Right-hand cutting
- For centring 60° without protective countersink
- For straight contact surfaces in acc. with DIN 332 A

	P	M	K	N	S	H	O
XPL	●●	●●	●●	●●	●●	●●	●●

DIN 333	D _c k12 mm	d ₁ h9 mm	l ₁ mm	Designation K1161XPL
Cylindrical shank	0,5	3,15	25	★ -0,5
	0,8	3,15	25	★ -0,8
	1	3,15	32	★ -1
	1,25	3,15	32	★ -1,25
	1,6	4	36	★ -1,6
	2	5	40	★ -2
	2,5	6,3	45	★ -2,5
	3,15	8	50	★ -3,15
	4	10	56	★ -4
	5	12,5	63	★ -5
	6,3	16	71	★ -6,3

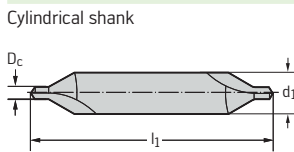

D_c 0.5/0.8 single-sided

★ New addition to range



Walter Select for carbide and HSS reamers

Step by step to the correct tool

STEP 1

Determine the **material** to be machined from page H 8 in the Walter General catalogue 2012.

Note the **machining group** that corresponds to your material e.g.: K5.

Code letter	Machining group	Groups of the materials to be machined	
P	P1–P15	Steel	All types of steel and cast steel, with the exception of steel with an austenitic structure
M	M1–M3	Stainless steel	Stainless austenitic steel and austenitic-ferritic steel and cast steel
K	K1–K7	Cast iron	Grey cast iron, cast iron with spheroidal graphite, malleable cast iron, cast iron with vermicular graphite
N	N1–N10	NF metals	Aluminium and other non-ferrous metals, non-ferrous materials
S	S1–S10	High temperature alloys and titanium alloys	Heat resisting special alloys based on iron, nickel and cobalt, titanium and titanium alloys
H	H1–H4	Hard materials	Hardened steel, hardened cast iron materials, chilled cast iron
O	O1–O6	Other	Plastics, glass- and carbon fibre reinforced plastics, graphite

STEP 2

Select the **machining conditions**:

Machine stability, clamping system and workpiece		
very good	good	moderate
😊	😐	😞

STEP 3

Select your tool from the table from page B-88:

- In acc. with **DIN, form** and the **drill hole type** (e.g. DIN 345, form C, blind hole)
- In acc. with **machining conditions** (see step 2: 😊 😐 😞)
- For the relevant **machining group** (see step 1: P1-P15; M1-M3; ... O1-O6)

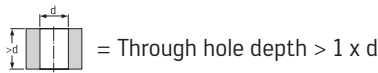
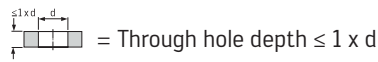
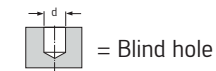

				Dimensions		Walter standard		
				Machining conditions	☺	☺		
				Designation	F2482	F2482TMS		
				Form	A	A		
				Type	Straight flute	Straight flute		
				Ø range (mm)	3.97 – 20.00	3.97 – 20.00		
				Cutting tool material	K10F	K10F		
Coating	uncoated	TMS						
Hole type								
Page	B-98	B-100						
Material group	Grouping of main material groups and code letters			Brinell hardness HB	Tensile strength R _m N/mm ²	Machining group	Tool images	
	Workpiece material							
P	Non-alloyed and low-alloyed steel	annealed (tempered)	210	700	P1, P2, P3, P4, P7	•	••	
		machining steel	220	750	P6	•	••	
		tempered	300	1010	P5, P8	•	••	
	High-alloyed steel and high-alloyed tool steel	tempered	380	1280	P9	•	••	
		annealed	430	1480	P10	•	••	
		annealed	200	670	P11	•	••	
		hardened and tempered	300	1010	P12	•	••	
	Stainless steel	hardened and tempered	400	1360	P12	•	••	
		ferritic/martensitic, annealed	200			•	••	
		martensitic, tempered				•	••	

STEP 4

Choose your **cutting data** from the table from page B - 118 onwards:

- **Cutting speed:** v_c
- **Feed:** VRR (feed rating chart)

Go to the row of your machining group (e.g. K5) and the column of your selected reamer. You will find the cutting speed v_c and the VRR there.

The feed rating chart (VRR) can be found from page B-125 onwards.

				Dimensions		Walter standard						
☺ = Cutting data for wet machining ☹ = Dry machining is possible, cutting data must be selected from Walter GPS E = Emulsion O = Oil M = MOL L = Dry v _c = Cutting speed VRR = Feed rating chart from page B-125				Designation	F2482	F2482TMS						
				Form	-	-						
				Type	Straight flute	Straight flute						
				Ø range (mm)	3.97 – 20.00	3.97 – 20.00						
				Cutting tool material	K10F	K10F						
				Coating	uncoated	TMS						
Page	B-98	B-100										
Material group	Structure of main material groups and code letters			Brinell hardness HB	Tensile strength R _m N/mm ²	Machining group	Tool images					
	Workpiece material											
P	Non-alloyed steel	C ≤ 0.25%	annealed	125	428	P1	45	8	OE	190	20	OE
		C > 0.25... ≤ 0.55%	annealed	190	639	P2	40	8	OE	175	20	OE
		C > 0.25... ≤ 0.55%	tempered	210	708	P3	40	8	OE	170	20	OE
		C > 0.55%	annealed	190	639	P4	40	8	OE	175	20	OE
		C > 0.55%	tempered	300	1013	P5	30	8	OE	130	20	OE
	Low-alloyed steel	machining steel (short-chipping)	annealed	220	745	P6	45	8	OE	190	20	OE
		annealed	175	591	P7	40	8	OE	175	20	OE	
		tempered	300	1013	P8	30	8	OE	130	20	OE	
		tempered	380	1282	P9	20	8	OE	80	20	OE	
		tempered	430	1477	P10	10	8	OE	50	20	OE	
High-alloyed steel and high-alloyed tool steel	annealed	200	675	P11	25	8	OE	110	20	OE		
	hardened and tempered	300	1013	P12	20	8	OE	95	20	OE		
	hardened and tempered	400	1361	P13	15	8	OE	65	20	OE		
Stainless steel	ferritic/martensitic, annealed	200	675	P14	25	8	OE	110	20	OE		
	martensitic, tempered	330	1114	P15	20	8	OE	80	20	OE		
	200	675	M1									
M	Stainless steel	austenitic, quench hardened	300	1013	M2							
	austenitic, precipitation hardened (PH)	230	778	M3								
	austenitic/ferritic, duplex	300										
Malleable cast iron												

Walter Select – Reaming Carbide and HSS reamers

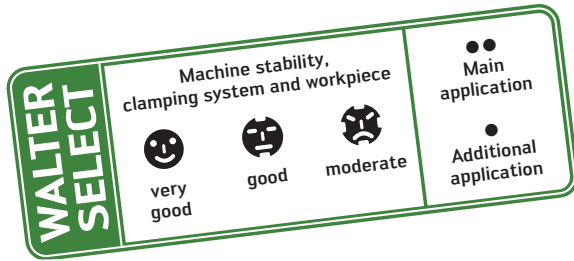

Dimensions	Walter standard	
Machining conditions	☺	☺
Designation	F2482	F2482TMS
Form	A	A
Type	Straight flute	Straight flute
Ø range (mm)	3,97 – 20,00	3,97 – 20,00
Cutting tool material	K10F	K10F
Coating	uncoated	TMS
Hole type		
Page	B-98	B-100

Material group	Grouping of main material groups and code letters		Brinell hardness HB	Tensile strength R _m N/mm ²	Machining group		
	Workpiece material						
P	Non-alloyed and low-alloyed steel	annealed (tempered)	210	700	P1, P2, P3, P4, P7	●	●●
		machining steel	220	750	P6	●	●●
		tempered	300	1010	P5, P8	●	●●
		tempered	380	1280	P9	●	●●
		tempered	430	1480	P10	●	●●
	High-alloyed steel and high-alloyed tool steel	annealed	200	670	P11	●	●●
		hardened and tempered	300	1010	P12	●	●●
hardened and tempered		400	1360	P13	●	●●	
Stainless steel	ferritic/martensitic, annealed	200	670	P14	●	●●	
	martensitic, tempered	330	1110	P15	●	●●	
M	Stainless steel	austenitic, duplex	230	780	M1, M3		
		austenitic, precipitation hardened (PH)	300	1010	M2		
K	Grey cast iron		245	–	K3, K4	●	●●
	Cast iron with spheroidal graphite	ferritic, pearlitic	365	–	K1, K2, K5, K6	●	●●
	GGV (CGI)		200	–	K7	●	●●
N	Aluminium wrought alloys	cannot be hardened	30	–	N1	●●	
		hardenable, hardened	100	340	N2	●●	
	Cast aluminium alloys	≤ 12% Si	90	310	N3, N4	●●	
		> 12% Si	130	450	N5	●●	
	Magnesium alloys		70	250	N6	●●	
	Copper and copper alloys (bronze/brass)	non-alloyed, electrolytic copper	100	340	N7	●●	
		brass, bronze, red brass	90	310	N8	●●	
Cu-alloys, short-chipping		110	380	N9	●●		
	high-strength, Ampco	300	1010	N10	●●		
S	Heat-resistant alloys	Fe-based	280	940	S1, S2		
		Ni or Co base	250	840	S3		
		Ni or Co base	350	1080	S4, S5		
	Titanium alloys	pure titanium	200	670	S6		
		α and β alloys, hardened	375	1260	S7		
		β alloys	410	1400	S8		
	Tungsten alloys		300	1010	S9		
Molybdenum alloys		300	1010	S10			
H	Hardened steel		50 HRC	–	H1		
			55 HRC	–	H2, H4		
			60 HRC	–	H3		
O	Thermoplasts	without abrasive fillers			01	●●	
	Thermosetting plastics	without abrasive fillers			02	●●	
	Plastic, fibre-reinforced	GFRP, AFRP			03, 05	●	
		CFRP			04		
Graphite (technical)			65	06			

* The pages indicated in italics refer to the Walter General catalogue 2012.

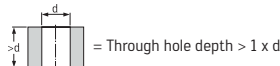
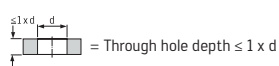
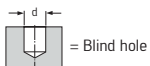

	Walter standard						DIN 212	
	☺	☺	☹	☹	☺	☹	☹	☹
	F2481	F2481TMS	F2162	F2171	F4162	F4171	F1342	F1352 F1352HUN
	B	B	A / C	B / D	A	B	A / C	B / D
	Left-hand spiral	Left-hand spiral	Straight flute	Left-hand spiral	Straight flute	Left-hand spiral	Straight flute	Left-hand spiral
	3,97 – 20,00	3,97 – 20,00	4,00 – 20,00	2,00 – 20,00	5,00 – 32,00	5,00 – 20,00	1,00 – 20,00	0,90 – 20,00
	K10F	K10F	K10	K10	K10	K10	HSS-E	HSS-E
	uncoated	TMS	uncoated	uncoated	uncoated	uncoated	uncoated	uncoated
	B-94	B-96	B-92	B-93	<i>B 341*</i>	<i>B 342*</i>	<i>B 322*</i>	<i>B 325* / B 329*</i>
	•	••	••	••	••	••	••	••
	•	••	••	••	••	••	••	••
	•	••	••	••	••	••	•	•
	•	••	••	••	••	••	•	•
	•	••	••	••	••	••	•	•
	•	••	••	••	••	••	•	•
	•	••	••	••	••	••	•	•
	•	••	••	••	••	••	•	•
	•	••	••	••	••	••	•	•
	•	••	••	••	••	••	•	•
			••	••	••	••		
			••	••	••	••		
	•	••	••	••	••	••	••	••
	•	••	••	••	••	••	••	••
	•	••	••	••	••	••	•	•
	••	••	••	••	••	••	••	••
	••	••	••	••	••	••	••	••
	••	••	••	••	••	••	••	••
	••	••	••	••	••	••	••	••
	••	••	••	••	••	••	••	••
	••	••	••	••	••	••	••	••
	••	••	••	••	••	••	••	••
	••	••	••	••	••	••	•	•
			••	••	••	••		
			••	••	••	••		
			•	•	•	•		
			••	••	••	••		
			••	••	••	••		
			•	•	•	•		
			•	•	•	•		
			•	•	•	•		
			••	••	••	••		
	••		••	••	••	••	••	••
	••		••	••	••	••	•	•
	•		•	•	•	•		

Walter Select – Reaming Carbide and HSS reamers

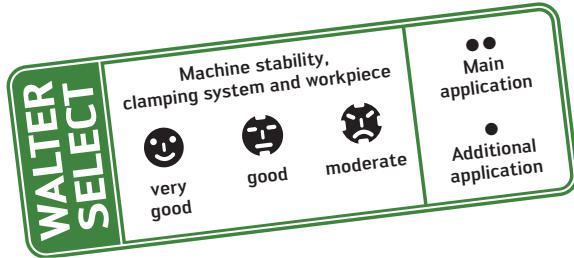

Dimensions	DIN 208	
Machining conditions		
Designation	F4142	F4152
Form	A	B
Type	Straight flute	Left-hand spiral
Ø range (mm)	5,00 – 32,00	5,00 – 40,00
Cutting tool material	HSS-E	HSS-E
Coating	uncoated	uncoated
Hole type		
Page	<i>B 337*</i>	<i>B 338*</i>

Material group	Grouping of main material groups and code letters		Brinell hardness HB	Tensile strength R _m N/mm ²	Machining group		
	Workpiece material						
P	Non-alloyed and low-alloyed steel	annealed (tempered)	210	700	P1, P2, P3, P4, P7	●●	●●
		machining steel	220	750	P6	●●	●●
		tempered	300	1010	P5, P8	●	●
		tempered	380	1280	P9		
		tempered	430	1480	P10		
	High-alloyed steel and high-alloyed tool steel	annealed	200	670	P11	●	●
		hardened and tempered	300	1010	P12		
		hardened and tempered	400	1360	P13		
	Stainless steel	ferritic/martensitic, annealed	200	670	P14	●	●
		martensitic, tempered	330	1110	P15		
M	Stainless steel	austenitic, duplex	230	780	M1, M3		
		austenitic, precipitation hardened (PH)	300	1010	M2		
	Grey cast iron		245	–	K3, K4	●●	●●
K	Cast iron with spheroidal graphite	ferritic, pearlitic	365	–	K1, K2, K5, K6	●●	●●
	GGV (CGI)		200	–	K7	●	●
N	Aluminium wrought alloys	cannot be hardened	30	–	N1	●●	●●
		hardenable, hardened	100	340	N2	●●	●●
	Cast aluminium alloys	≤ 12% Si	90	310	N3, N4	●●	●●
		> 12% Si	130	450	N5		
	Magnesium alloys		70	250	N6	●●	●●
	Copper and copper alloys (bronze/brass)	non-alloyed, electrolytic copper	100	340	N7	●●	●●
		brass, bronze, red brass	90	310	N8	●●	●●
Cu-alloys, short-chipping		110	380	N9	●	●	
	high-strength, Ampco	300	1010	N10			
S	Heat-resistant alloys	Fe-based	280	940	S1, S2		
		Ni or Co base	250	840	S3		
		Ni or Co base	350	1080	S4, S5		
	Titanium alloys	pure titanium	200	670	S6		
		α and β alloys, hardened	375	1260	S7		
		β alloys	410	1400	S8		
Tungsten alloys		300	1010	S9			
Molybdenum alloys		300	1010	S10			
H	Hardened steel		50 HRC	–	H1		
			55 HRC	–	H2, H4		
			60 HRC	–	H3		
O	Thermoplasts	without abrasive fillers			O1	●●	●●
	Thermosetting plastics	without abrasive fillers			O2	●	●
	Plastic, fibre-reinforced	GFRP, AFRP			O3, O5		
		CFRP			O4		
Graphite (technical)			65	O6			

* The pages indicated in italics refer to the Walter General catalogue 2012.

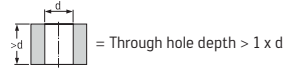
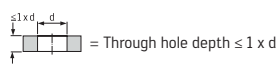
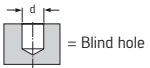

	DIN 219	DIN 2179	DIN 2180	DIN 311	DIN 206	DIN 859
	F7133	F3234	F6134	F4535	F1131	F1231
	B	-	-	-	Hand reamer	Adjustable hand reamer
	Left-hand spiral	For tapered holes 1:50	For tapered holes 1:50	Bridge reamers	Left-hand spiral	Left-hand spiral
	25,00 – 60,00	1,00 – 12,00	5,00 – 20,00	6,40 – 32,00	1,00 – 50,00	8,00 – 30,00
	HSS	HSS-E	HSS-E	HSS	HSS	HSS
	uncoated	uncoated	uncoated	uncoated	uncoated	uncoated
	B 345* / G 66*	B 334*	B 344*	B 343*	B 317*	B 321*
	••	••	••	••	••	••
	••	••	••	••	••	••
	•	•	•	•	•	•
	•	•	•	•	•	•
	•	•	•	•	•	•
	••	••	••	••	••	••
	••	••	••	••	••	••
	•	•	•	•	•	•
	••	••	••	••	••	••
	••	••	••	••	••	••
	••	••	••	••	••	••
	•	•	•	•	•	•
	••	••	••	••	••	••
	••	••	••	••	••	••
	••	••	••	••	••	••
	•	•	•	•	•	•
	••	••	••	••	••	••
	••	••	••	••	••	••
	•	•	•	•	•	•

Carbide machine reamers

F2162

H7

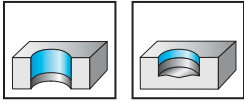

- K10 - uncoated
- Form A
- Right handed - straight flute
- Differential pitch
- Solid carbide up to Ø 13, solid carbide point over Ø 13

	P	M	K	N	S	H	O
uncoated	●●	●●	●●	●●	●●	●	●●

	D_c mm	d_1 h6 mm	L_c mm	l_1 mm	l_5 mm	Z	Designation F2162
Shank DIN 6535 HA	4	4	19	75	28	6	★ -4
	4,5	6	21	80	36	6	★ -4.5
	5	6	23	86	36	6	★ -5
	5,5	6	26	93	36	6	★ -5.5
	6	6	26	93	36	6	★ -6
	6,5	6	28	101	36	6	★ -6.5
	7	8	31	109	36	6	★ -7
	7,5	8	31	109	36	6	★ -7.5
	8	8	33	117	36	6	★ -8
	8,5	8	33	117	36	6	★ -8.5
	9	10	36	125	40	6	★ -9
	9,5	10	36	125	40	6	★ -9.5
	10	10	38	133	40	6	★ -10
	11	12	41	142	45	6	★ -11
	12	12	44	151	45	6	★ -12
	13	12	44	151	45	6	★ -13
	14	16	47	160	48	8	★ -14
	15	16	50	162	48	8	★ -15
	16	16	52	170	48	8	★ -16
	17	18	52	175	48	8	★ -17
	18	18	52	182	48	8	★ -18
	20	20	52	195	50	8	★ -20

Dimensions similar to DIN 8093

★ New addition to range



G-2

B-102

Carbide machine reamers

F2171

H7

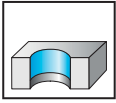

- K10 - uncoated
- Form B
- Right handed - spiral flute
- Differential pitch
- Solid carbide up to Ø 13, solid carbide point over Ø 13

	P	M	K	N	S	H	O
uncoated	●	●	●	●	●	●	●

	D _c mm	d ₁ h6 mm	L _c mm	l ₁ mm	l ₅ mm	Z	Designation F2171
Shank DIN 6535 HA	2	4	12	49	28	4	★ -2
	2,5	4	16	59	28	4	★ -2.5
	3	4	17	63	28	6	★ -3
	3,2	4	18	65	28	6	★ -3.2
	3,5	4	18	70	28	6	★ -3.5
	4	4	19	75	28	6	★ -4
	4,5	6	21	80	36	6	★ -4.5
	5	6	23	86	36	6	★ -5
	5,5	6	26	93	36	6	★ -5.5
	6	6	26	93	36	6	★ -6
	6,5	6	28	101	36	6	★ -6.5
	7	8	31	109	36	6	★ -7
	7,5	8	31	109	36	6	★ -7.5
	8	8	33	117	36	6	★ -8
	8,5	8	33	117	36	6	★ -8.5
	9	10	36	125	40	6	★ -9
	10	10	38	133	40	6	★ -10
	11	12	41	142	45	6	★ -11
	12	12	44	151	45	6	★ -12
	13	12	44	151	45	6	★ -13
	14	16	47	160	48	8	★ -14
	15	16	50	162	48	8	★ -15
	16	16	52	170	48	8	★ -16
	18	18	52	182	48	8	★ -18
	20	20	52	195	50	8	★ -20

Dimensions similar to DIN 8093

★ New addition to range



G-2

B-102

Solid carbide HSC reaming tools

F2481

H7

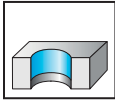

- K10F - uncoated
- Right handed - spiral flute
- Differential pitch
- Tolerance for 1/100 size: +0.004 mm

	P	M	K	N	S	H	O
uncoated	●	●	●	●●	●	●	●●

	D _c mm	d ₁ h6 mm	d ₃ mm	L _c mm	l ₁ mm	l ₃ mm	l ₅ mm	Z	Designation F2481
Shank DIN 6535 HA	3,97	6	3,4	12	75	34	36	4	★ -3.97
	3,98	6	3,4	12	75	34	36	4	★ -3.98
	3,99	6	3,4	12	75	34	36	4	★ -3.99
	4	6	3,4	12	75	34	36	4	★ -4
	4,01	6	3,4	12	75	34	36	4	★ -4.01
	4,02	6	3,4	12	75	34	36	4	★ -4.02
	4,03	6	3,4	12	75	34	36	4	★ -4.03
	4,5	6	3,4	12	75	34	36	4	★ -4.5
	4,97	6	3,8	12	75	35	36	4	★ -4.97
	4,98	6	3,8	12	75	35	36	4	★ -4.98
	4,99	6	3,8	12	75	35	36	4	★ -4.99
	5	6	3,8	12	75	35	36	4	★ -5
	5,01	6	3,8	12	75	35	36	4	★ -5.01
	5,02	6	3,8	12	75	35	36	4	★ -5.02
	5,03	6	3,8	12	75	35	36	4	★ -5.03
	5,5	6	4,2	12	75	35	36	4	★ -5.5
	5,97	6	4,5	12	75	35	36	4	★ -5.97
	5,98	6	4,5	12	75	35	36	4	★ -5.98
	5,99	6	4,5	12	75	35	36	4	★ -5.99
	6	6	4,5	12	75	35	36	4	★ -6
	6,01	6	4,5	12	75	35	36	4	★ -6.01
	6,02	6	4,5	12	75	35	36	4	★ -6.02
	6,03	6	4,5	12	75	35	36	4	★ -6.03
	6,5	8	4,8	16	100	59	36	6	★ -6.5
	7	8	5	16	100	59	36	6	★ -7
	7,5	8	5,5	16	100	60	36	6	★ -7.5
	7,97	8	6	16	100	60	36	6	★ -7.97
	7,98	8	6	16	100	60	36	6	★ -7.98
7,99	8	6	16	100	60	36	6	★ -7.99	
8	8	6	16	100	60	36	6	★ -8	
8,01	8	6	16	100	60	36	6	★ -8.01	
8,02	8	6	16	100	60	36	6	★ -8.02	
8,03	8	6	16	100	60	36	6	★ -8.03	
8,5	10	6,5	20	100	55	40	6	★ -8.5	
9	10	7	20	100	55	40	6	★ -9	
9,5	10	7,5	20	120	76	40	6	★ -9.5	
9,97	10	7,5	20	120	76	40	6	★ -9.97	
9,98	10	7,5	20	120	76	40	6	★ -9.98	
9,99	10	7,5	20	120	76	40	6	★ -9.99	
10	10	7,5	20	120	76	40	6	★ -10	
10,01	10	7,5	20	120	76	40	6	★ -10.01	
10,02	10	7,5	20	120	76	40	6	★ -10.02	
10,03	10	7,5	20	120	76	40	6	★ -10.03	
10,5	12	8	20	120	70	45	6	★ -10.5	
11	12	8,5	20	120	70	45	6	★ -11	
11,5	12	8,5	20	120	71	45	6	★ -11.5	
11,97	12	9	20	120	71	45	6	★ -11.97	

Continued

★ New addition to range



Solid carbide HSC reaming tools

F2481

H7



Continued

	P	M	K	N	S	H	O
uncoated	●		●	●●			●●

	D _c mm	d ₁ h6 mm	d ₃ mm	L _c mm	l ₁ mm	l ₃ mm	l ₅ mm	Z	Designation F2481
Shank DIN 6535 HA	11,98	12	9	20	120	71	45	6	★ -11.98
	11,99	12	9	20	120	71	45	6	★ -11.99
	12	12	9	20	120	71	45	6	★ -12
	12,01	12	9	20	120	71	45	6	★ -12.01
	12,02	12	9	20	120	71	45	6	★ -12.02
	12,03	12	9	20	120	71	45	6	★ -12.03
	13	14	10	22	130	80	45	6	★ -13
	14	14	10,5	22	130	80	45	6	★ -14
	15	16	11,5	22	130	77	48	6	★ -15
	16	16	12	25	150	97	48	6	★ -16
	17	18	13	25	150	97	48	8	★ -17
	18	18	13,5	25	150	97	48	8	★ -18
	19	20	14	25	150	95	50	8	★ -19
	20	20	14,5	25	150	95	50	8	★ -20

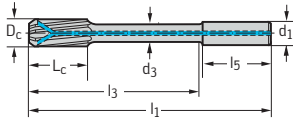

★ New addition to range



Solid carbide HSC reaming tools

F2481TMS

H7

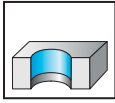

- K10F - TMS
- Right handed - spiral flute
- Differential pitch
- Tolerance for 1/100 size: +0.004 mm

	P	M	K	N	S	H	O
TMS	●●		●●				

	D _c mm	d ₁ h6 mm	d ₃ mm	L _c mm	l ₁ mm	l ₃ mm	l ₅ mm	Z	Designation F2481TMS
Shank DIN 6535 HA	3,97	6	3,4	12	75	34	36	4	★ -3.97
	3,98	6	3,4	12	75	34	36	4	★ -3.98
	3,99	6	3,4	12	75	34	36	4	★ -3.99
	4	6	3,4	12	75	34	36	4	★ -4
	4,01	6	3,4	12	75	34	36	4	★ -4.01
	4,02	6	3,4	12	75	34	36	4	★ -4.02
	4,03	6	3,4	12	75	34	36	4	★ -4.03
	4,5	6	3,4	12	75	34	36	4	★ -4.5
	4,97	6	3,8	12	75	35	36	4	★ -4.97
	4,98	6	3,8	12	75	35	36	4	★ -4.98
	4,99	6	3,8	12	75	35	36	4	★ -4.99
	5	6	3,8	12	75	35	36	4	★ -5
	5,01	6	3,8	12	75	35	36	4	★ -5.01
	5,02	6	3,8	12	75	35	36	4	★ -5.02
	5,03	6	3,8	12	75	35	36	4	★ -5.03
	5,5	6	4,2	12	75	35	36	4	★ -5.5
	5,97	6	4,5	12	75	35	36	4	★ -5.97
	5,98	6	4,5	12	75	35	36	4	★ -5.98
	5,99	6	4,5	12	75	35	36	4	★ -5.99
	6	6	4,5	12	75	35	36	4	★ -6
6,01	6	4,5	12	75	35	36	4	★ -6.01	
6,02	6	4,5	12	75	35	36	4	★ -6.02	
6,03	6	4,5	12	75	35	36	4	★ -6.03	
6,5	8	4,8	16	100	59	36	6	★ -6.5	
7	8	5	16	100	59	36	6	★ -7	
7,5	8	5,5	16	100	60	36	6	★ -7.5	
7,97	8	6	16	100	60	36	6	★ -7.97	
7,98	8	6	16	100	60	36	6	★ -7.98	
7,99	8	6	16	100	60	36	6	★ -7.99	
8	8	6	16	100	60	36	6	★ -8	
8,01	8	6	16	100	60	36	6	★ -8.01	
8,02	8	6	16	100	60	36	6	★ -8.02	
8,03	8	6	16	100	60	36	6	★ -8.03	
8,5	10	6,5	20	100	55	40	6	★ -8.5	
9	10	7	20	100	55	40	6	★ -9	
9,5	10	7,5	20	120	76	40	6	★ -9.5	
9,97	10	7,5	20	120	76	40	6	★ -9.97	
9,98	10	7,5	20	120	76	40	6	★ -9.98	
9,99	10	7,5	20	120	76	40	6	★ -9.99	
10	10	7,5	20	120	76	40	6	★ -10	
10,01	10	7,5	20	120	76	40	6	★ -10.01	
10,02	10	7,5	20	120	76	40	6	★ -10.02	
10,03	10	7,5	20	120	76	40	6	★ -10.03	
10,5	12	8	20	120	70	45	6	★ -10.5	
11	12	8,5	20	120	70	45	6	★ -11	
11,5	12	8,5	20	120	71	45	6	★ -11.5	
11,97	12	9	20	120	71	45	6	★ -11.97	

Continued

★ New addition to range



Solid carbide HSC reaming tools

F2481TMS

H7



Continued

	P	M	K	N	S	H	O
TMS	●●		●●				

	D _c mm	d ₁ h6 mm	d ₃ mm	L _c mm	l ₁ mm	l ₃ mm	l ₅ mm	Z	Designation F2481TMS
	11,98	12	9	20	120	71	45	6	★ -11,98
	11,99	12	9	20	120	71	45	6	★ -11,99
	12	12	9	20	120	71	45	6	★ -12
	12,01	12	9	20	120	71	45	6	★ -12,01
	12,02	12	9	20	120	71	45	6	★ -12,02
	12,03	12	9	20	120	71	45	6	★ -12,03
	13	14	10	22	130	80	45	6	★ -13
	14	14	10,5	22	130	80	45	6	★ -14
	15	16	11,5	22	130	77	48	6	★ -15
	16	16	12	25	150	97	48	6	★ -16
	17	18	13	25	150	97	48	8	★ -17
	18	18	13,5	25	150	97	48	8	★ -18
	19	20	14	25	150	95	50	8	★ -19
	20	20	14,5	25	150	95	50	8	★ -20

★ New addition to range



Solid carbide HSC reaming tools

F2482

H7

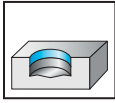

- K10F - uncoated
- Right handed - straight flute
- Differential pitch
- Tolerance for 1/100 size: +0.004 mm

	P	M	K	N	S	H	O
uncoated	●	●	●	●●	●	●	●●

	D _c mm	d ₁ h6 mm	d ₃ mm	L _c mm	l ₁ mm	l ₃ mm	l ₅ mm	Z	Designation F2482
Shank DIN 6535 HA	3,97	6	3,5	12	75	34	36	4	★ -3.97
	3,98	6	3,5	12	75	34	36	4	★ -3.98
	3,99	6	3,5	12	75	34	36	4	★ -3.99
	4	6	3,5	12	75	34	36	4	★ -4
	4,01	6	3,5	12	75	34	36	4	★ -4.01
	4,02	6	3,5	12	75	34	36	4	★ -4.02
	4,03	6	3,5	12	75	34	36	4	★ -4.03
	4,5	6	4	12	75	34	36	4	★ -4.5
	4,97	6	4,4	12	75	35	36	4	★ -4.97
	4,98	6	4,4	12	75	35	36	4	★ -4.98
	4,99	6	4,4	12	75	35	36	4	★ -4.99
	5	6	4,4	12	75	35	36	4	★ -5
	5,01	6	4,4	12	75	35	36	4	★ -5.01
	5,02	6	4,4	12	75	35	36	4	★ -5.02
	5,03	6	4,4	12	75	35	36	4	★ -5.03
	5,5	6	4,9	12	75	35	36	4	★ -5.5
	5,97	6	5,3	12	75	35	36	4	★ -5.97
	5,98	6	5,3	12	75	35	36	4	★ -5.98
	5,99	6	5,3	12	75	35	36	4	★ -5.99
	6	6	5,3	12	75	35	36	4	★ -6
	6,01	6	5,3	12	75	35	36	4	★ -6.01
	6,02	6	5,3	12	75	35	36	4	★ -6.02
	6,03	6	5,3	12	75	35	36	4	★ -6.03
	6,5	8	5,7	16	100	59	36	6	★ -6.5
	7	8	6,2	16	100	59	36	6	★ -7
	7,5	8	6,7	16	100	60	36	6	★ -7.5
	7,97	8	7,2	16	100	60	36	6	★ -7.97
	7,98	8	7,2	16	100	60	36	6	★ -7.98
7,99	8	7,2	16	100	60	36	6	★ -7.99	
8	8	7,2	16	100	60	36	6	★ -8	
8,01	8	7,2	16	100	60	36	6	★ -8.01	
8,02	8	7,2	16	100	60	36	6	★ -8.02	
8,03	8	7,2	16	100	60	36	6	★ -8.03	
8,5	10	7,7	20	100	55	40	6	★ -8.5	
9	10	8,2	20	100	55	40	6	★ -9	
9,5	10	8,7	20	120	76	40	6	★ -9.5	
9,97	10	9	20	120	76	40	6	★ -9.97	
9,98	10	9	20	120	76	40	6	★ -9.98	
9,99	10	9	20	120	76	40	6	★ -9.99	
10	10	9	20	120	76	40	6	★ -10	
10,01	10	9	20	120	76	40	6	★ -10.01	
10,02	10	9	20	120	76	40	6	★ -10.02	
10,03	10	9	20	120	76	40	6	★ -10.03	
10,5	12	9,5	20	120	70	45	6	★ -10.5	
11	12	10	20	120	70	45	6	★ -11	
11,5	12	10,5	20	120	71	45	6	★ -11.5	
11,97	12	11	20	120	71	45	6	★ -11.97	

Continued

★ New addition to range



Solid carbide HSC reaming tools

F2482

H7



Continued

	P	M	K	N	S	H	O
uncoated	●		●	●●			●●

	D _c mm	d ₁ h6 mm	d ₃ mm	L _c mm	l ₁ mm	l ₃ mm	l ₅ mm	Z	Designation F2482
Shank DIN 6535 HA	11,98	12	11	20	120	71	45	6	★ -11.98
	11,99	12	11	20	120	71	45	6	★ -11.99
	12	12	11	20	120	71	45	6	★ -12
	12,01	12	11	20	120	71	45	6	★ -12.01
	12,02	12	11	20	120	71	45	6	★ -12.02
	12,03	12	11	20	120	71	45	6	★ -12.03
	13	14	11,5	22	130	80	45	6	★ -13
	14	14	12,5	22	130	80	45	6	★ -14
	15	16	13,5	22	130	77	48	6	★ -15
	16	16	14,2	25	150	97	48	6	★ -16
	17	18	15,2	25	150	97	48	8	★ -17
	18	18	16,2	25	150	97	48	8	★ -18
	19	20	17,2	25	150	95	50	8	★ -19
	20	20	18,2	25	150	95	50	8	★ -20

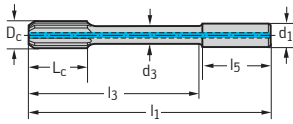

★ New addition to range



Solid carbide HSC reaming tools

F2482TMS

H7

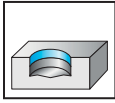

- K10F - TMS
- Right handed - straight flute
- Differential pitch
- Tolerance for 1/100 size: +0.004 mm

	P	M	K	N	S	H	O
TMS	●●		●●				

	D _c mm	d ₁ h6 mm	d ₃ mm	L _c mm	l ₁ mm	l ₃ mm	l ₅ mm	Z	Designation F2482TMS
Shank DIN 6535 HA	3,97	6	3,5	12	75	34	36	4	★ -3.97
	3,98	6	3,5	12	75	34	36	4	★ -3.98
	3,99	6	3,5	12	75	34	36	4	★ -3.99
	4	6	3,5	12	75	34	36	4	★ -4
	4,01	6	3,5	12	75	34	36	4	★ -4.01
	4,02	6	3,5	12	75	34	36	4	★ -4.02
	4,03	6	3,5	12	75	34	36	4	★ -4.03
	4,5	6	4	12	75	34	36	4	★ -4.5
	4,97	6	4,4	12	75	35	36	4	★ -4.97
	4,98	6	4,4	12	75	35	36	4	★ -4.98
	4,99	6	4,4	12	75	35	36	4	★ -4.99
	5	6	4,4	12	75	35	36	4	★ -5
	5,01	6	4,4	12	75	35	36	4	★ -5.01
	5,02	6	4,4	12	75	35	36	4	★ -5.02
	5,03	6	4,4	12	75	35	36	4	★ -5.03
	5,5	6	4,9	12	75	35	36	4	★ -5.5
	5,97	6	5,3	12	75	35	36	4	★ -5.97
	5,98	6	5,3	12	75	35	36	4	★ -5.98
	5,99	6	5,3	12	75	35	36	4	★ -5.99
	6	6	5,3	12	75	35	36	4	★ -6
	6,01	6	5,3	12	75	35	36	4	★ -6.01
	6,02	6	5,3	12	75	35	36	4	★ -6.02
	6,03	6	5,3	12	75	35	36	4	★ -6.03
	6,5	8	5,7	16	100	59	36	6	★ -6.5
	7	8	6,2	16	100	59	36	6	★ -7
	7,5	8	6,7	16	100	60	36	6	★ -7.5
	7,97	8	7,2	16	100	60	36	6	★ -7.97
	7,98	8	7,2	16	100	60	36	6	★ -7.98
7,99	8	7,2	16	100	60	36	6	★ -7.99	
8	8	7,2	16	100	60	36	6	★ -8	
8,01	8	7,2	16	100	60	36	6	★ -8.01	
8,02	8	7,2	16	100	60	36	6	★ -8.02	
8,03	8	7,2	16	100	60	36	6	★ -8.03	
8,5	10	7,7	20	100	55	40	6	★ -8.5	
9	10	8,2	20	100	55	40	6	★ -9	
9,5	10	8,7	20	120	76	40	6	★ -9.5	
9,97	10	9	20	120	76	40	6	★ -9.97	
9,98	10	9	20	120	76	40	6	★ -9.98	
9,99	10	9	20	120	76	40	6	★ -9.99	
10	10	9	20	120	76	40	6	★ -10	
10,01	10	9	20	120	76	40	6	★ -10.01	
10,02	10	9	20	120	76	40	6	★ -10.02	
10,03	10	9	20	120	76	40	6	★ -10.03	
10,5	12	9,5	20	120	70	45	6	★ -10.5	
11	12	10	20	120	70	45	6	★ -11	
11,5	12	10,5	20	120	71	45	6	★ -11.5	
11,97	12	11	20	120	71	45	6	★ -11.97	

Continued

★ New addition to range



Solid carbide HSC reaming tools

F2482TMS

H7



Continued

	P	M	K	N	S	H	O
TMS	●●		●●				

	D _c mm	d ₁ h6 mm	d ₃ mm	L _c mm	l ₁ mm	l ₃ mm	l ₅ mm	Z	Designation F2482TMS
Shank DIN 6535 HA	11,98	12	11	20	120	71	45	6	★ -11.98
	11,99	12	11	20	120	71	45	6	★ -11.99
	12	12	11	20	120	71	45	6	★ -12
	12,01	12	11	20	120	71	45	6	★ -12.01
	12,02	12	11	20	120	71	45	6	★ -12.02
	12,03	12	11	20	120	71	45	6	★ -12.03
	13	14	11,5	22	130	80	45	6	★ -13
	14	14	12,5	22	130	80	45	6	★ -14
	15	16	13,5	22	130	77	48	6	★ -15
	16	16	14,2	25	150	97	48	6	★ -16
	17	18	15,2	25	150	97	48	8	★ -17
	18	18	16,2	25	150	97	48	8	★ -18
	19	20	17,2	25	150	95	50	8	★ -19
	20	20	18,2	25	150	95	50	8	★ -20

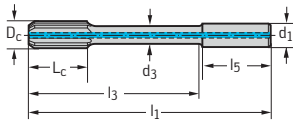

★ New addition to range



Cutting data for solid carbide drills with internal cooling

Material group	= Cutting data for wet machining = Dry machining is possible, cutting data must be selected from Walter GPS			Drilling depth		3 x D _c								
				Designation		K3299XPL K3899XPL				A3289DPL				
				Type		X-treme Step 90				X-treme Plus				
				Dimensions		Walter standard				DIN 6537 K				
			Ø range (mm)		3,30 – 14,00				3,00 – 20,00					
			Cutting tool material		K30F				K30F					
			Coating		XPL				DPL					
			Page		B-75 / B-77				B 70*					
Structure of main material groups and code letters			Brinell hardness HB	Tensile strength R _m N/mm ²	Machining group ¹									
Workpiece material			v _c	VRR		v _c	VRR		v _c	VRR				
P	Non-alloyed steel	C ≤ 0.25%	annealed	125	428	P1	140	12	EO	ML	200	16	EO	ML
		C > 0.25... ≤ 0.55%	annealed	190	639	P2	140	12	EO	ML	180	12	EO	ML
		C > 0.25... ≤ 0.55%	tempered	210	708	P3	130	12	EO	ML	170	12	EO	ML
		C > 0.55%	annealed	190	639	P4	140	12	EO	ML	180	12	EO	ML
		C > 0.55%	tempered	300	1013	P5	105	10	EO	ML	140	12	EO	ML
		machining steel (short-chipping)	annealed	220	745	P6	150	12	EO	ML	200	16	EO	ML
		Low-alloyed steel	annealed	175	591	P7	140	12	EO	ML	180	12	EO	ML
			tempered	300	1013	P8	105	10	EO	ML	140	12	EO	ML
			tempered	380	1282	P9	80	7	OE		100	8	OE	
			tempered	430	1477	P10	63	5	OE		80	6	OE	
		High-alloyed steel and high-alloyed tool steel	annealed	200	675	P11	71	9	EO		85	9	EO	
			hardened and tempered	300	1013	P12	95	9	EO		120	10	EO	
		Stainless steel	hardened and tempered	400	1361	P13	63	5	OE		80	6	OE	
			ferritic/martensitic, annealed	200	675	P14	71	9	EO		85	9	EO	
			martensitic, tempered	330	1114	P15	40	8	EO		50	9	EO	
M	Stainless steel	austenitic, quench hardened	200	675	M1	40	6	EO		50	6	EO		
		austenitic, precipitation hardened (PH)	300	1013	M2	45	6	EO		63	6	EO		
		austenitic/ferritic, duplex	230	778	M3	34	5	EO		40	6	EO		
K	Malleable cast iron	ferritic	200	675	K1	100	16	EO	ML	130	20	EO	ML	
		pearlitic	260	867	K2	63	10	EO	ML	120	16	EO	ML	
	Grey cast iron	low tensile strength	180	602	K3	125	16	EO	ML	160	20	EO	ML	
		high tensile strength/austenitic	245	825	K4	105	16	EO	ML	130	20	EO	ML	
	Cast iron with spheroidal graphite	ferritic	155	518	K5	130	16	EO	ML	150	16	EO	ML	
		pearlitic	265	885	K6	95	16	EO	ML	120	16	EO	ML	
		GGV (CGI)	200	675	K7	110	16	EO	ML	140	16	EO	ML	
N	Aluminium wrought alloys	cannot be hardened	30	-	N1	400	16	EO	M	450	16	EO	M	
		hardenable, hardened	100	343	N2	400	16	EO	M	450	16	EO	M	
	Cast aluminium alloys	≤ 12% Si, cannot be hardened	75	260	N3	250	16	EO	M	320	16	EO	M	
		≤ 12% Si, hardenable, hardened	90	314	N4	240	16	EO	M	300	16	EO	M	
		> 12% Si, cannot be hardened	130	447	N5	190	16	EO	M	250	16	EO	M	
		Magnesium alloys	70	250	N6	240	16	ML		300	16	ML		
	Copper and copper alloys (bronze/brass)	non-alloyed, electrolytic copper	100	343	N7	190	8	EO	M	280	12	EO	M	
brass, bronze, red brass		90	314	N8	160	10	EO		240	16	EO			
Cu-alloys, short-chipping		110	382	N9	190	16	EO	M	260	20	EO	M		
high-strength, Ampco		300	1013	N10	60	5	EO		120	10	EO			
S	Heat-resistant alloys	Fe-based	annealed	200	675	S1	50	6	EO		50	6	EO	
			hardened	280	943	S2	30	5	OE		38	5	OE	
		Ni or Co base	annealed	250	839	S3	34	5	EO		42	5	EO	
			hardened	350	1177	S4	19	4	OE		26	4	OE	
			cast	320	1076	S5	26	4	OE		32	4	OE	
	Titanium alloys	pure titanium	200	675	S6	56	6	OE		71	6	OE		
		α and β alloys, hardened	375	1262	S7	50	5	OE		63	5	OE		
		β alloys	410	1396	S8	12,5	4	OE		20	4	OE		
		Tungsten alloys	300	1013	S9	60	5	EO		120	10	EO		
		Molybdenum alloys	300	1013	S10	60	5	EO		120	10	EO		
H	Hardened steel	hardened and tempered	50 HRC	-	H1	48	4	OE		53	4	OE		
		hardened and tempered	55 HRC	-	H2	32	3	OE		45	4	OE		
		hardened and tempered	60 HRC	-	H3	-	-			-	-			
		Hardened cast iron	hardened and tempered	55 HRC	-	H4	32	3	OE		45	4	OE	
O	Thermoplasts	without abrasive fillers			O1	100	16	EO		130	16	EO		
	Thermosetting plastics	without abrasive fillers			O2									
	Plastic, glass fibre reinforced	GFRP			O3									
	Plastic, carbon fibre reinforced	CFRP			O4									
	Plastic, aramid fibre reinforced	AFRP			O5									
		Graphite (technical)		80 Shore		O6								

¹ The classification of the machining groups can be found in the Walter General catalogue 2012 from page H 8 onwards.

* The pages indicated in italics refer to the Walter General catalogue 2012.

The specified cutting data are average recommended values.
For special applications, adjustment is recommended.

3 x D _c												5 x D _c															
A3293TTP				A3299XPL A3899XPL				A3389AML				A3389DPL				A3393TTP				A3382XPL				A3399XPL A3999XPL			
X-treme Inox				X-treme				X-treme M				X-treme Plus				X-treme Inox				X-treme CI				X-treme			
DIN 6537 K				DIN 6537 K				Walter Norm				DIN 6537 L				DIN 6537 L				DIN 6537 L				DIN 6537 L			
3,00 – 20,00				3,00 – 20,00				2,00 – 2,95				3,00 – 20,00				3,00 – 20,00				3,00 – 20,00				3,00 – 25,00			
K30F				K30F				K30F				K30F				K30F				K30F				K30F			
TTP				XPL				AML				DPL				TTP				XPL				XPL			
B-30				B-33 / B-54				B-41				B 86*				B-42				B 81*				B 89* / B 112*			
v _c		VRR		E		M		L		E		M		L		E		M		L		E		M		L	
160	10	EO	ML	140	12	EO	ML	C100	12	E		190	12	EO	ML	150	10	EO	ML					120	10	EO	ML
120	10	EO	ML	140	12	EO	ML	C80	12	E		170	12	EO	ML	110	10	EO	ML					100	10	EO	ML
110	10	EO	ML	130	12	EO	ML	C80	12	E		160	12	EO	ML	100	10	EO	ML					95	10	EO	ML
120	10	EO	ML	140	12	EO	ML	C100	12	E		170	12	EO	ML	110	10	EO	ML					100	10	EO	ML
				105	10	EO	ML	C71	12	E		130	12	EO	ML									71	8	EO	ML
145	12	EO	ML	150	12	EO	ML	C100	12	E		190	16	EO	ML	135	12	EO	ML					120	12	EO	ML
120	10	EO	ML	140	12	EO	ML	C80	12	E		170	12	EO	ML	110	10	EO	ML					100	10	EO	ML
				80	7	OE		C56	9	E		95	8	OE										48	6	OE	
				63	5	OE		C40	6	E		71	6	OE										38	4	OE	
				71	9	EO		C63	10	E		85	9	EO										63	8	EO	
				95	9	EO		C63	12	E		120	10	EO										56	7	EO	
				63	5	OE		C40	6	E		71	6	OE										38	4	OE	
95	9	EO		71	9	EO		C63	10	E		85	9	EO		90	9	EO						63	8	EO	
55	8	EO		40	8	EO		C50	8	E		48	9	EO		50	8	EO						42	7	EO	
53	6	EO		40	6	EO		C40	8	E		48	6	EO		50	6	EO						38	5	EO	
68	6	EO		45	6	EO		C63	10	E		60	6	EO		65	6	EO						42	6	EO	
53	6	EO		34	5	EO		C32	5	E		38	6	EO		50	6	EO						31	5	EO	
				100	16	EO	ML	C160	21	E		125	16	EO	ML									130	20	EO	ML
				63	10	EO	ML	C160	21	E		120	16	EO	ML									120	16	EO	ML
				125	16	EO	ML	C160	21	E		150	16	EO	ML									160	20	EO	ML
				105	16	EO	ML	C160	21	E		125	16	EO	ML									130	20	EO	ML
				130	16	EO	ML	C160	21	E		140	16	E	ML									160	20	EO	ML
				95	16	EO	ML	C125	16	E		120	16	EO	ML									120	16	EO	ML
				110	16	EO	ML	C140	19	E		130	16	OE	ML									140	20	EO	ML
450	16	EO	M	400	16	EO	M	C160	26	E		450	16	EO	M	450	16	EO	M					400	16	EO	M
450	16	EO	M	400	16	EO	M	C160	26	E		450	16	EO	M	450	16	EO	M					400	16	EO	M
250	16	EO	M	250	16	EO	M	C160	24	E		320	16	EO	M	250	16	EO	M					250	16	EO	M
240	16	EO	M	240	16	EO	M	C160	24	E		300	16	EO	M	240	16	EO	M					240	16	EO	M
190	16	EO	M	190	16	EO	M	C125	20	E		250	16	EO	M	190	16	EO	M					190	16	EO	M
240	16	ML		240	16	ML		ML				300	16	ML		240	16	ML						240	16	ML	
210	9	EO	M	190	8	EO	M	C100	6	E		240	10	EO	M	210	9	EO	M					180	8	EO	M
180	12	EO		160	10	EO		C80	12	E		200	12	EO		180	12	EO						150	10	EO	
190	16	EO	M	190	16	EO	M	C100	20	E		260	20	EO	M	190	16	EO	M					190	16	EO	M
60	7	EO		60	5	EO		C56	8	E		120	10	EO		60	7	EO						56	7	EO	
50	6	EO		50	6	EO		C50	8	E		48	6	EO		48	6	EO						42	5	EO	
38	5	OE		30	5	OE		C26	6	E		36	5	OE		36	5	OE						24	4	OE	
42	5	EO		34	5	EO		C32	5	E		40	5	EO		40	5	EO						30	4	EO	
26	4	OE		19	4	OE		C16	6	E		24	4	OE		24	4	OE						15	3	OE	
32	4	OE		26	4	OE		C16	6	E		30	4	OE		30	4	OE						18	3	OE	
71	6	OE		56	6	OE		C50	6	E		60	6	OE		60	6	OE						48	6	OE	
63	5	OE		50	5	OE		C32	5	E		53	5	OE		53	5	OE						40	5	OE	
20	4	OE		12,5	4	OE		C16	5	E		18	4	OE		18	4	OE						11	3	OE	
120	9	EO		60	5	EO		C56	8	E		120	10	EO		120	9	EO						56	7	EO	
120	9	EO		60	5	EO		C56	8	E		120	10	EO		120	9	EO						56	7	EO	
				48	4	OE		C32	3	E		53	4	OE										30	3	OE	
				32	3	OE		C32	3	E		45	4	OE										26	3	OE	
				32	3	OE		C32	3	E		45	4	OE										26	3	OE	
130	16	EO		100	16	EO		C100	22	E		130	16	EO		130	16	EO									

Cutting data for solid carbide drills with internal cooling

= Cutting data for wet machining = Dry machining is possible, cutting data must be selected from Walter GPS E = Emulsion O = Oil M = MQL L = Dry v _c = Cutting speed V _{CRR} = v _c rating chart from page B-122 V _{RR} = Feed rating chart from page B-124			Drilling depth			5 x D _c							
			Designation			A3387			A3384				
Type			Alpha® Jet			Alpha® Ni							
Dimensions			DIN 6537 L			DIN 6537 L							
Ø range (mm)			4,00 – 20,00			3,00 – 12,00							
Cutting tool material			K20F			K20F							
Coating			uncoated			uncoated							
Page			<i>B 85*</i>			<i>B 84*</i>							
Material group	Structure of main material groups and code letters		Brinell hardness HB	Tensile strength R _m N/mm ²	Machining group ¹								
	Workpiece material					v _c	V _{RR}	v _c	V _{RR}	v _c	V _{RR}	v _c	V _{RR}
P	Non-alloyed steel	C ≤ 0.25%	annealed	125	428	P1							
		C > 0.25... ≤ 0.55%	annealed	190	639	P2							
		C > 0.25... ≤ 0.55%	tempered	210	708	P3							
		C > 0.55%	annealed	190	639	P4							
		C > 0.55%	tempered	300	1013	P5							
	Low-alloyed steel	machining steel (short-chipping)	annealed	220	745	P6							
		annealed		175	591	P7							
		tempered		300	1013	P8							
		tempered		380	1282	P9							
		tempered		430	1477	P10			50	5	O E		
	High-alloyed steel and high-alloyed tool steel	annealed		200	675	P11							
		hardened and tempered		300	1013	P12							
		hardened and tempered		400	1361	P13			50	5	O E		
	Stainless steel	ferritic/martensitic, annealed		200	675	P14							
		martensitic, tempered		330	1114	P15							
M	Stainless steel	austenitic, quench hardened		200	675	M1							
		austenitic, precipitation hardened (PH)		300	1013	M2							
		austenitic/ferritic, duplex		230	778	M3							
K	Malleable cast iron	ferritic		200	675	K1	100	10	E O				
		pearlitic		260	867	K2	75	10	E O				
	Grey cast iron	low tensile strength		180	602	K3	125	10	E O M L				
		high tensile strength/austenitic		245	825	K4	100	10	E O M L				
	Cast iron with spheroidal graphite	ferritic		155	518	K5	100	6	E O				
		pearlitic		265	885	K6							
GGV (CGI)			200	675	K7	75	10	E O					
N	Aluminium wrought alloys	cannot be hardened		30	–	N1	400	9	E O				
		hardenable, hardened		100	343	N2	400	9	E O				
	Cast aluminium alloys	≤ 12% Si, cannot be hardened		75	260	N3	260	9	E O				
		≤ 12% Si, hardenable, hardened		90	314	N4	240	9	E O				
		> 12% Si, cannot be hardened		130	447	N5	200	9	E O				
	Magnesium alloys		70	250	N6	240	9	M L					
	Copper and copper alloys (bronze/brass)	non-alloyed, electrolytic copper		100	343	N7							
brass, bronze, red brass			90	314	N8								
Cu-alloys, short-chipping			110	382	N9	210	16	E O					
high-strength, Ampco			300	1013	N10								
S	Heat-resistant alloys	Fe-based	annealed	200	675	S1							
			hardened	280	943	S2			28	5	O E		
		Ni or Co base	annealed	250	839	S3							
			hardened	350	1177	S4			20	5	O E		
			cast	320	1076	S5			24	4	O E		
	Titanium alloys	pure titanium		200	675	S6							
		α and β alloys, hardened		375	1262	S7			53	5	O E		
		β alloys		410	1396	S8			16	5	O E		
	Tungsten alloys		300	1013	S9								
	Molybdenum alloys		300	1013	S10								
H	Hardened steel	hardened and tempered		50 HRC	–	H1			32	4	O E		
		hardened and tempered		55 HRC	–	H2			32	4	O E		
		hardened and tempered		60 HRC	–	H3							
	Hardened cast iron	hardened and tempered		55 HRC	–	H4			32	4	O E		
O	Thermoplasts	without abrasive fillers				O1	80	8	E O				
	Thermosetting plastics	without abrasive fillers				O2	130	16	L	130	16	L	
	Plastic, glass fibre reinforced	GFRP				O3			50	5	L		
	Plastic, carbon fibre reinforced	CFRP				O4							
	Plastic, aramid fibre reinforced	AFRP				O5			50	5	L		
	Graphite (technical)		80 Shore			O6	30	5	L	30	5	L	

¹ The classification of the machining groups can be found in the Walter General catalogue 2012 from page H 8 onwards.

* The pages indicated in italics refer to the Walter General catalogue 2012.

The specified cutting data are average recommended values.
For special applications, adjustment is recommended.

	8 x D _c												12 x D _c											
	A6489AMP			A6488TML			A6489DPP			A3487			A3486TIP A3586TIP			A6589AMP			A6588TML					
	X-treme DM8			Alpha® 4 Plus Micro			X-treme D8			Alpha® Jet			Alpha® 44			X-treme DM12			Alpha® 4 Plus Micro					
	Walter standard			Walter standard			Walter standard			Walter standard			Walter standard			Walter standard			Walter standard					
	2,00 – 2,95			0,75 – 1,95			3,00 – 20,00			5,00 – 20,00			5,00 – 12,00			2,00 – 2,90			1,00 – 1,90					
	K30F			K30F			K30F			K20F			K30F			K30F			K30F					
	AMP			TML			DPP			uncoated			TIP			AMP			TML					
	B-76			B 121*			B 123*			B 95*			B 94* / B 96*			B-68			B 126*					
	VCRR	VRR		VCRR	VRR		v _c	VRR		v _c	VRR		v _c	VRR		VCRR	VRR		VCRR	VRR				
	C100	12	E	C80	10	E	180	12	EO ML				95	9	EO	C80	12	E	C63	10	E			
	C80	12	E	C80	10	E	160	12	EO ML				90	9	EO	C80	12	E	C63	10	E			
	C80	12	E	C71	10	E	150	12	EO ML				80	9	EO	C80	12	E	C63	10	E			
	C80	12	E	C80	10	E	160	12	EO ML				90	9	EO	C80	12	E	C63	10	E			
	C71	12	E	C56	8	E	125	10	EO ML				60	7	EO	C59	10	E	C53	8	E			
	C100	12	E	C80	10	E	180	12	EO ML				95	10	EO	C80	12	E	C70	10	E			
	C80	12	E	C80	10	E	160	12	EO ML				90	9	EO	C80	12	E	C63	10	E			
	C71	12	E	C56	8	E	125	10	EO ML				60	7	EO	C59	10	E	C53	8	E			
	C53	8	E	C42	6	E	85	7	OE							C45	7	E	C36	6	E			
	C40	6	E	C32	5	E	63	5	OE							C40	6	E	C32	5	E			
	C63	10	E	C50	8	E	80	8	EO				50	6	EO	C63	10	E	C50	8	E			
	C63	10	E	C50	6	E	110	9	EO				45	5	EO	C50	8	E	C40	6	E			
	C40	6	E	C32	5	E	63	5	OE							C40	6	E	C32	5	E			
	C63	10	E	C50	8	E	80	8	EO				50	6	EO	C63	10	E	C50	8	E			
	C50	8	E	C32	7	E	45	8	EO				32	5	EO	C50	8	E	C32	7	E			
	C40	8	E	C32	6	E	45	6	EO				32	4	EO	C40	7	E	C32	6	E			
	C50	8	E	C40	5	E	56	6	EO				42	4	EO	C50	7	E	C32	4	E			
	C32	5	E	C20	4	E	36	6	EO				26	4	EO	C25	5	E	C16	4	E			
	C125	17	E	C80	12	E	120	12	EO ML	85	9	EO	80	12	EO	C100	13	E	C80	12	E			
	C125	17	E	C80	12	E	110	12	EO ML	63	9	EO	60	12	EO	C100	13	E	C80	11	E			
	C125	17	E	C80	13	E	140	12	EO ML	105	9	EO ML	90	12	EO	C100	13	E	C80	11	E			
	C125	17	E	C80	10	E	120	12	EO ML	85	9	EO ML	80	12	EO	C100	13	E	C63	8	E			
	C125	17	E	C80	13	E	140	12	EO ML				80	12	EO	C100	13	E	C63	11	E			
	C100	14	E	C63	10	E	110	12	EO ML				56	10	EO	C80	11	E	C50	9	E			
	C110	16	E	C71	12	E	125	12	EO ML				67	12	EO	C100	12	E	C67	12	E			
	C160	26	E	C125	17	E	450	16	EO M	400	9	EO	320	10	EO	C160	25	E	C100	16	E			
	C160	26	E	C125	17	E	450	16	EO M	400	9	EO	320	10	EO	C160	25	E	C100	16	E			
	C160	24	E	C125	17	E	320	16	EO M	260	9	EO	220	10	EO	C160	23	E	C100	16	E			
	C160	24	E	C100	15	E	300	16	EO M	240	9	EO	200	10	EO	C160	23	E	C100	13	E			
	C125	20	E	C100	13	E	250	16	EO M	200	9	EO	160	10	EO	C125	19	E	C100	12	E			
							300	16	ML	240	9	ML	200	10	ML									
	C80	6	E	C63	5	E	200	9	EO M				160	5	EO	C80	6	E	C63	5	E			
	C80	12	E	C63	7	E	170	12	EO				105	8	EO	C80	11	E	C63	7	E			
	C100	20	E	C80	11	E	260	20	EO M	210	16	EO	140	12	EO	C80	19	E	C80	10	E			
	C52	8	E	C40	4	E	110	9	EO				45	5	EO	C50	7	E	C40	3	E			
	C40	8	E	C32	6	E	45	6	EO				32	4	EO	C40	7	E	C32	5	E			
	C24	6	E	C16	5	E	32	5	OE							C21	6	E	C16	4	E			
	C32	5	E	C20	5	E	38	5	EO				20	3	EO	C25	5	E	C20	4	E			
	C16	6	E	C12	4	E	21	4	OE							C16	5	E	C12	3	E			
	C16	6	E	C12	4	E	26	4	OE							C16	5	E	C12	4	E			
	C50	6	E	C40	5	E	50	5	OE				38	4	OE	C40	6	E	C32	5	E			
	C32	5	E	C25	4	E	45	5	OE				32	3	OE	C32	5	E	C25	4	E			
	C16	5	E	C12	4	E	16	4	OE							C16	5	E	C12	3	E			
	C52	8	E	C40	4	E	110	9	EO				45	5	EO	C56	8	E	C40	3	E			
	C52	8	E	C40	4	E	110	9	EO				45	5	EO	C56	8	E	C40	3	E			
	C32	3	E	C25	2	E	45	3	OE							C32	3	E	C20	2	E			
	C32	3	E	C25	2	E	38	3	OE							C32	3	E	C20	2	E			
	C32	3	E	C25	2	E	38	3	OE							C32	3	E	C20	2	E			
	C100	22	E	C100	20	E	130	16	EO	80	8	EO	100	16	EO	C100	20	E	C80	18	E			
										130	16	L												
										30	5	L												

Cutting data for solid carbide drills with internal cooling

= Cutting data for wet machining = Dry machining is possible, cutting data must be selected from Walter GPS E = Emulsion O = Oil M = MQL L = Dry v_c = Cutting speed V_{CRR} = v _c rating chart from page B-122 VRR = Feed rating chart from page B-124				Drilling depth		12 x D _c							
				Designation		A6589DPP			A3687				
Structure of main material groups and code letters				Type		X-treme D12			Alpha® Jet				
				Dimensions		Walter standard			Walter standard				
Workpiece material				Ø range (mm)		3,00 – 20,00			5,00 – 20,00				
				Cutting tool material		K30F			K20F				
Brinell hardness HB Tensile strength R _m N/mm ² Machining group ¹				Coating		DPP			uncoated				
				Page		B 127*			B 97*				
P	Non-alloyed steel	C ≤ 0.25%	annealed	125	428	P1	170	12	E O M L				
		C > 0.25... ≤ 0.55%	annealed	190	639	P2	150	12	E O M L				
		C > 0.25... ≤ 0.55%	tempered	210	708	P3	140	12	E O M L				
		C > 0.55%	annealed	190	639	P4	150	12	E O M L				
		C > 0.55%	tempered	300	1013	P5	120	10	E O M L				
	Low-alloyed steel	machining steel (short-chipping)	annealed	220	745	P6	170	12	E O M L				
		annealed		175	591	P7	150	12	E O M L				
		tempered		300	1013	P8	120	10	E O M L				
		tempered		380	1282	P9	80	7	O E				
		tempered		430	1477	P10	56	5	O E				
	High-alloyed steel and high-alloyed tool steel	annealed		200	675	P11	75	8	E O				
		hardened and tempered		300	1013	P12	105	9	E O				
		hardened and tempered		400	1361	P13	56	5	O E				
	Stainless steel	ferritic/martensitic, annealed		200	675	P14	75	8	E O				
		martensitic, tempered		330	1114	P15	42	8	E O				
M	Stainless steel	austenitic, quench hardened		200	675	M1	42	6	E O				
		austenitic, precipitation hardened (PH)		300	1013	M2	56	6	E O				
		austenitic/ferritic, duplex		230	778	M3	34	6	E O				
K	Malleable cast iron	ferritic		200	675	K1	110	12	E O M L	80	8	E O	
		pearlitic		260	867	K2	83	12	E O M L	60	8	E O	
	Grey cast iron	low tensile strength		180	602	K3	130	12	E O M L	100	8	E O M L	
		high tensile strength/austenitic		245	825	K4	110	12	E O M L	80	8	E O M L	
	Cast iron with spheroidal graphite	ferritic		155	518	K5	130	12	E O M L				
pearlitic			265	885	K6	105	12	E O M L					
	GGV (CGI)		200	675	K7	120	12	E O M L					
N	Aluminium wrought alloys	cannot be hardened		30	-	N1	420	16	E O M	380	9	E O	
		hardenable, hardened		100	343	N2	420	16	E O M	380	9	E O	
	Cast aluminium alloys	≤ 12% Si, cannot be hardened		75	260	N3	320	16	E O M	250	9	E O	
		≤ 12% Si, hardenable, hardened		90	314	N4	280	16	E O M	240	9	E O	
		> 12% Si, cannot be hardened		130	447	N5	240	16	E O M	190	9	E O	
	Magnesium alloys			70	250	N6	280	16	M L	240	9		
		Copper and copper alloys (bronze/brass)	non-alloyed, electrolytic copper		100	343	N7	190	8	E O M			
brass, bronze, red brass			90	314	N8	160	10	E O					
Cu-alloys, short-chipping			110	382	N9	250	20	E O M	200	16	E O		
	high-strength, Ampco		300	1013	N10	105	9	E O					
S	Heat-resistant alloys	Fe-based	annealed	200	675	S1	42	6	E O				
			hardened	280	943	S2	30	4	O E				
		Ni or Co base	annealed	250	839	S3	36	5	E O				
			hardened	350	1177	S4	18	3	O E				
			cast	320	1076	S5	22	3	O E				
	Titanium alloys	pure titanium		200	675	S6	45	5	O E				
α and β alloys, hardened			375	1262	S7	40	4	O E					
β alloys			410	1396	S8	14	3	O E					
Tungsten alloys		300	1013	S9	105	9	E O						
Molybdenum alloys		300	1013	S10	105	9	E O						
H	Hardened steel	hardened and tempered		50 HRC	-	H1	38	3	O E				
		hardened and tempered		55 HRC	-	H2	32	3	O E				
		hardened and tempered		60 HRC	-	H3							
	Hardened cast iron	hardened and tempered		55 HRC	-	H4	32	3	O E				
O	Thermoplasts	without abrasive fillers				O1	125	16	E O	75	8	E O	
	Thermosetting plastics	without abrasive fillers				O2				130	16	L	
	Plastic, glass fibre reinforced	GFRP					O3						
		CFRP					O4						
		AFRP					O5						
	Graphite (technical)		80 Shore			O6				30	5	L	

¹ The classification of the machining groups can be found in the Walter General catalogue 2012 from page H 8 onwards.

* The pages indicated in italics refer to the Walter General catalogue 2012.

The specified cutting data are average recommended values.
For special applications, adjustment is recommended.

	16 x D _c										20 x D _c										25 x D _c														
	A6689AMP					A6685TFP					A6789AMP					A6794TFP					A6785TFP					A6889AMP					A6885TFP				
	X-treme DM16					Alpha® 4 XD16					X-treme DM20					X-treme DH20					Alpha® 4 XD20					X-treme DM25					Alpha® 4 XD25				
	Walter standard					Walter standard					Walter standard					Walter standard					Walter standard					Walter standard									
	2,00 – 2,90					3,00 – 16,00					2,00 – 2,90					3,00 – 10,00					3,00 – 16,00					2,00 – 2,90					3,00 – 12,00				
	K30F					K30F					K30F					K30F					K30F					K30F									
	AMP					TFP					AMP					TFP					TFP					AMP					TFP				
	B-69					B 130*					B 132*					B 133*					B 131*					B 135*					B 134*				
	VCRR		VRR		v _c		VRR		VCRR		VRR		v _c		VRR		VCRR		VRR		v _c		VRR		VCRR		VRR		v _c		VRR				
C80	10	E			110	10	EO	ML	C80	10	E						105	10	EO	ML	C80	10	E			95	9	EO	ML						
C71	10	E			95	10	EO	ML	C63	10	E						90	10	EO	ML	C63	10	E			85	9	EO	ML						
C63	10	E			90	10	EO	ML	C71	10	E						85	10	EO	ML	C63	10	E			80	9	EO	ML						
C71	10	E			95	10	EO	ML	C63	10	E						90	10	EO	ML	C63	10	E			85	9	EO	ML						
C45	6	E			67	9	EO	ML	C50	8	E		63	8	EO	ML	63	8	EO	ML	C50	8	E			60	8	EO	ML						
C80	10	E			110	12	EO	ML	C80	10	E						105	10	EO	ML	C80	10	E			95	10	EO	ML						
C71	10	E			95	10	EO	ML	C63	10	E						90	10	EO	ML	C63	10	E			85	9	EO	ML						
C45	6	E			67	9	EO	ML	C50	8	E		63	8	EO	ML	63	8	EO	ML	C50	8	E			60	8	EO	ML						
C45	10	E			42	7	OE		C36	5	E		40	7	OE	ML	40	7	OE		C36	5	E			36	6	OE							
C36	5	E			28	6	OE		C32	5	E		25	6	OE		25	6	OE		C32	5	E			24	5	OE							
C63	9	E			60	8	EO		C50	9	E		56	7	EO		56	8	EO		C50	9	E			53	7	EO							
C45	6	E			56	8	EO		C40	5	E		53	7	EO	ML	53	7	EO		C40	5	E			48	7	EO							
C45	10	E			28	6	OE		C32	5	E		25	6	OE		25	6	OE		C32	5	E			24	5	OE							
C50	10	E			60	8	EO		C50	9	E		56	7	EO		56	8	EO		C50	9	E			53	7	EO							
C45	4	E			40	7	EO		C40	8	E		36	6	EO		36	6	EO		C40	8	E			34	6	EO							
C36	7	E			40	5	OE		C32	6	E						36	5	OE		C32	6	E			34	4	OE							
C45	4	E			50	5	EO		C32	4	E		48	5	EO		48	5	EO		C32	4	E			45	5	EO							
C28	5	E			32	5	OE		C25	4	E						29	5	OE		C25	4	E			27	4	OE							
C71	10	E			90	16	EO	ML	C63	8	E						85	12	EO	ML	C63	8	E			80	12	EO	ML						
C63	10	E			67	12	EO	ML	C63	8	E						63	12	EO	ML	C63	8	E			60	12	EO	ML						
C90	10	E			110	16	EO	ML	C80	8	E						105	12	EO	ML	C80	8	E			95	12	EO	ML						
C71	11	E			90	16	EO	ML	C63	8	E						85	12	EO	ML	C63	8	E			80	12	EO	ML						
C80	12	E			90	16	EO	ML	C63	8	E						85	12	EO	ML	C63	8	E			80	12	EO	ML						
C63	10	E			67	12	EO	ML	C50	8	E		63	12	EO	ML	63	12	EO	ML	C50	8	E			60	12	EO	ML						
C63	9	E			80	16	EO	ML	C63	9	E		71	12	EO	ML	75	12	EO	ML	C63	9	E			71	12	EO	ML						
C125	24	E			130	16	EO	M	C125	22	E						105	16	EO	M	C125	22	E			80	16	EO	M						
C125	24	E			130	16	EO	M	C125	22	E						105	16	EO	M	C125	22	E			80	16	EO	M						
C125	22	E			130	16	EO	M	C125	20	E						105	16	EO	M	C125	20	E			80	16	EO	M						
C125	22	E			130	16	EO	M	C125	20	E						105	16	EO	M	C125	20	E			80	16	EO	M						
C100	18	E			130	16	EO	M	C100	17	E						105	16	EO	M	C100	17	E			80	12	EO	M						
					130	16		ML									105	16		ML						80	16		ML						
C63	5	E			110	7	EO	M	C63	5	E						105	7	EO	M	C63	5	E			95	6	EO	M						
C80	9	E			90	9	EO		C63	10	E						85	9	EO		C63	10	E			80	8	EO							
C80	18	E			110	10	EO	M	C80	17	E						105	10	EO	M	C80	17	E			95	10	EO	M						
C40	5	E			56	8	EO		C45	6	E		53	7	EO	M	53	7	EO		C45	6	E			48	7	EO							
C20	5	E			40	5	OE		C32	6	E						36	5	OE		C32	6	E			34	4	OE							
C28	5	E			24	4	OE		C21	5	E		16	3	OE		21	3	OE		C19	5	E			20	3	OE							
C14	5	E			30	4	EO		C25	4	E						28	3	EO		C25	4	E			26	3	EO							
C14	5	E			13	3	OE		C14	5	E		12	3	OE		12	3	OE		C14	5	E			11	2	OE							
C25	5	E			16	3	OE		C14	5	E		15	3	OE		15	3	OE		C14	5	E			14	2	OE							
C40	5	E			36	5	OE		C40	5	E						34	5	OE		C40	5	E			32	5	OE							
C22	4	E			24	5	OE		C25	4	E						21	4	OE		C25	4	E			19	4	OE							
C18	3	E			9,5	3	OE		C14	4	E		9	3	OE		9	3	OE		C14	4	E			8,5	2	OE							
C14	5	E			56	8	EO		C45	7	E		53	7	EO	M	53	7	EO		C45	7	E			48	7	EO							
C14	5	E			56	8	EO		C45	7	E		53	7	EO	M	53	7	EO		C45	7	E			48	7	EO							
C28	3	E			22	2	OE		C25	3	E		21	2	OE		21	2	OE		C25	3	E			20	2	OE							
									C25	3	E										C25	3	E												
									C25	3	E										C25	3	E												
C90	20	E			90	16	EO		C100	20	E						85	12	EO		C100	20	E			80	12	EO							

Cutting data for solid carbide drills with internal cooling

Material group	= Cutting data for wet machining = Dry machining is possible, cutting data must be selected from Walter GPS E = Emulsion O = Oil M = MQL L = Dry v _c = Cutting speed V _{CRR} = v _c rating chart from page B-122 V _{RR} = Feed rating chart from page B-124			Drilling depth			30 x D _c							
				Designation			A6989AMP			A6994TFP				
				Type			X-treme DM30			X-treme DH30				
				Dimensions			Walter standard			Walter standard				
Ø range (mm)			2,00 – 2,90			3,00 – 10,00								
Cutting tool material			K30F			K30F								
Coating			AMP			TFP								
Page			B-72			B 137*								
Structure of main material groups and code letters			Brinell hardness HB	Tensile strength R _m N/mm ²	Machining group ¹									
Workpiece material						V _{CRR}	V _{RR}	v _c	V _{RR}					
P	Non-alloyed steel	C ≤ 0.25%	annealed	125	428	P1	C56	10	E					
		C > 0.25... ≤ 0.55%	annealed	190	639	P2	C50	10	E					
		C > 0.25... ≤ 0.55%	tempered	210	708	P3	C45	10	E					
		C > 0.55%	annealed	190	639	P4	C50	10	E					
		C > 0.55%	tempered	300	1013	P5	C23	4	E		60	8	EO	ML
		machining steel (short-chipping)	annealed	220	745	P6	C56	10	E					
		Low-alloyed steel	annealed	175	591	P7	C50	10	E					
	tempered		300	1013	P8	C23	4	E		60	8	EO	ML	
	tempered		380	1282	P9	C32	7	E		36	6	OE	ML	
	tempered		430	1477	P10	C25	4	E		24	5	OE		
		High-alloyed steel and high-alloyed tool steel	annealed	200	675	P11	C45	6	E		53	7	EO	
	hardened and tempered		300	1013	P12	C22	4	E		48	7	EO	ML	
		Stainless steel	hardened and tempered	400	1361	P13	C32	7	E		24	5	OE	
	ferritic/martensitic, annealed		200	675	P14	C36	10	E		53	7	EO		
			martensitic, tempered	330	1114	P15	C22	4	E		34	6	EO	
M	Stainless steel	austenitic, quench hardened	200	675	M1	C25	5	E						
		austenitic, precipitation hardened (PH)	300	1013	M2	C22	3	E		45	5	EO		
		austenitic/ferritic, duplex	230	778	M3	C18	3	E						
K	Malleable cast iron	ferritic	200	675	K1	C45	8	E						
		pearlitic	260	867	K2	C40	5	E						
	Grey cast iron	low tensile strength	180	602	K3	C45	8	E						
		high tensile strength/austenitic	245	825	K4	C45	7	E						
	Cast iron with spheroidal graphite	ferritic	155	518	K5	C50	7	E						
		pearlitic	265	885	K6	C40	5	E		60	12	EO	ML	
GGV (CGI)		200	675	K7	C40	5	E		71	12	OE	ML		
N	Aluminium wrought alloys	cannot be hardened	30	-	N1	C90	22	E						
		hardenable, hardened	100	343	N2	C90	22	E						
	Cast aluminium alloys	≤ 12% Si, cannot be hardened	75	260	N3	C90	15	E						
		≤ 12% Si, hardenable, hardened	90	314	N4	C90	15	E						
		> 12% Si, cannot be hardened	130	447	N5	C71	13	E						
	Magnesium alloys		70	250	N6									
	Copper and copper alloys (bronze/brass)	non-alloyed, electrolytic copper	100	343	N7	C32	4	E						
brass, bronze, red brass		90	314	N8	C56	6	E							
Cu-alloys, short-chipping		110	382	N9	C56	13	E							
high-strength, Ampco		300	1013	N10	C28	4	E		48	7	EO	M		
S	Heat-resistant alloys	Fe-based	annealed	200	675	S1	C14	3	E					
			hardened	280	943	S2	C20	4	E		15	2	OE	
		Ni or Co base	annealed	250	839	S3	C10	4	E					
			hardened	350	1177	S4	C10	3	E		11	2	OE	
			cast	320	1076	S5	C16	3	E		14	2	OE	
	Titanium alloys	pure titanium	200	675	S6	C28	4	E						
		α and β alloys, hardened	375	1262	S7	C14	3	E						
		β alloys	410	1396	S8	C12	2	E		9	2	OE		
Tungsten alloys		300	1013	S9	C10	4	E		48	7	EO	M		
Molybdenum alloys		300	1013	S10	C10	4	E		48	7	EO	M		
H	Hardened steel	hardened and tempered	50 HRC	-	H1	C20	2	E		20	2	OE		
		hardened and tempered	55 HRC	-	H2									
		hardened and tempered	60 HRC	-	H3									
	Hardened cast iron	hardened and tempered	55 HRC	-	H4									
O	Thermoplasts	without abrasive fillers			O1	C63	14	E						
	Thermosetting plastics	without abrasive fillers			O2									
	Plastic, glass fibre reinforced	GFRP			O3									
	Plastic, carbon fibre reinforced	CFRP			O4									
	Plastic, aramid fibre reinforced	AFRP			O5									
	Graphite (technical)		80 Shore			O6								







¹ The classification of the machining groups can be found in the Walter General catalogue 2012 from page H 8 onwards.

* The pages indicated in italics refer to the Walter General catalogue 2012.

The specified cutting data are average recommended values.
For special applications, adjustment is recommended.

30 x D _c				40 x D _c				Pilot drill																			
A6985TFP				A7495TTP				K3281TFT				A6181AML				A6181TFT				A7191TFT				K5191TFT			
Alpha® 4 XD30				X-treme D40				X-treme Pilot Step 90				X-treme Pilot 150				XD-Pilot				X-treme Pilot 180				X-treme Pilot 180C			
Walter standard				Walter standard				Walter standard				Walter standard				Walter standard				Walter standard				Walter standard			
3,00 – 12,00				4,50 – 11,00				3,00 – 16,00				2,00 – 2,95				3,00 – 16,00				3,00 – 10,00				4,00 – 7,00			
K30F				K30F				K30F				K30F				K30F				K30F				K30F			
TFP				TTP				TFT				AML				TFT				TFT				TFT			
B 136*				B-73				B-74				B 117*				B 118*				B 138*				B 140*			
v _c		VRR		E		M		L		E		M		L		E		M		L		E		M		L	
95	9	EO	ML	90	10	EO		120	12	EO	ML	C100	12	E		120	12	EO	ML	120	9	EO	ML	120	9	EO	ML
85	9	EO	ML	90	10	EO		105	12	EO	ML	C80	12	E		105	12	EO	ML	105	8	EO	ML	105	8	EO	ML
80	9	EO	ML	80	10	EO		100	12	EO	ML	C80	12	E		100	12	EO	ML	100	8	EO	ML	100	8	EO	ML
85	9	EO	ML	90	10	EO		105	12	EO	ML	C80	12	E		105	12	EO	ML	105	8	EO	ML	105	8	EO	ML
60	8	EO	ML	63	10	EO		75	9	EO	ML	C67	9	E		75	9	EO	ML	75	6	EO	ML	75	6	EO	ML
95	10	EO	ML	80	10	EO		120	12	EO	ML	C100	12	E		120	12	EO	ML	120	9	EO	ML	120	9	EO	ML
85	9	EO	ML	90	10	EO		105	12	EO	ML	C80	12	E		105	12	EO	ML	105	8	EO	ML	105	8	EO	ML
60	8	EO	ML	71	8	EO		75	9	EO	ML	C67	9	E		75	9	EO	ML	75	6	EO	ML	75	6	EO	ML
36	6	OE						50	6	OE	ML	C45	6	E		50	6	OE	ML	50	4	OE	ML	50	4	OE	ML
24	5	OE						42	4	OE		C40	6	E		42	4	OE		42	2	OE		42	2	OE	
53	7	EO		80	10	EO		67	9	EO		C63	10	E		67	9	EO		67	6	EO		67	6	EO	
48	7	EO		63	10	EO		60	7	EO	ML	C50	6	E		60	7	EO	ML	60	5	EO	ML	60	5	EO	ML
24	5	OE						42	4	OE		C40	6	E		42	4	OE		42	2	OE		42	2	OE	
53	7	EO		71	9	EO		67	9	EO		C63	10	E		67	9	EO		67	6	EO		67	6	EO	
34	6	EO		56	8	EO		42	7	EO		C50	8	E		42	7	EO		42	5	EO		42	5	EO	
34	4	OE		56	6	OE		42	5	EO		C40	8	E		42	5	EO		42	4	EO		42	4	EO	
45	5	EO						56	6	EO		C50	6	E		56	6	EO		56	4	EO		56	4	EO	
27	4	OE		50	6	OE		34	5	EO		C25	5	E		34	5	EO		34	4	EO		34	4	EO	
80	12	EO	ML	90	12	EO		100	16	EO	ML	C80	10	E		100	16	EO	ML	100	12	EO	ML	100	12	EO	ML
60	12	EO	ML	71	9	EO		75	16	EO	ML	C80	10	E		75	16	EO	ML	75	12	EO	ML	75	12	EO	ML
95	12	EO	ML	90	11	EO		120	16	EO	ML	C100	10	E		120	16	EO	ML	120	12	EO	ML	120	12	EO	ML
80	12	EO	ML	90	12	EO		100	16	EO	ML	C80	10	E		100	16	EO	ML	100	12	EO	ML	100	12	EO	ML
80	12	EO	ML	90	11	EO		95	20	E	ML	C80	10	E		95	20	E	ML	100	12	EO	ML	100	12	EO	ML
60	12	EO	ML	71	9	EO		75	16	EO	ML	C63	10	E		75	16	EO	ML	75	12	EO	ML	75	12	EO	ML
71	12	EO	ML	71	9	EO		85	20	OE	ML	C71	10	E		85	20	OE	ML	90	12	EO	ML	90	12	EO	ML
80	16	EO	M	90	13	EO		400	16	EO	M	C160	20	E		400	16	EO	M	400	12	EO	M	400	12	EO	M
80	16	EO	M	90	13	EO		400	16	EO	M	C160	20	E		400	16	EO	M	400	12	EO	M	400	12	EO	M
80	16	EO	M	90	13	EO		250	16	EO	M	C160	20	E		250	16	EO	M	250	12	EO	M	250	12	EO	M
80	16	EO	M	90	13	EO		240	16	EO	M	C160	20	E		240	16	EO	M	240	12	EO	M	240	12	EO	M
80	12	EO	M	90	13	EO		190	16	EO	M	C125	20	E		190	16	EO	M	190	10	EO	M	190	10	EO	M
80	16		ML					240	16		ML				240	16		ML	240	12		ML	240	12		ML	
95	6	EO	M	90	13	EO		210	9	EO	M	C80	6	E		210	9	EO	M	210	6	EO	M	210	6	EO	M
80	8	EO		90	13	EO		180	12	EO		C80	12	E		180	12	EO		180	8	EO		180	8	EO	
95	10	EO	M					190	16	EO	M	C100	20	E		190	16	EO	M	190	12	EO	M	190	12	EO	M
48	7	EO						60	7	EO	M	C56	8	E		60	7	EO	M	60	5	EO	M	60	5	EO	M
34	4	OE						42	5	EO		C40	8	E		42	5	EO		42	4	EO		42	4	EO	
20	3	OE						26	4	OE		C22	6	E		26	4	OE		26	3	OE		26	3	OE	
26	3	EO						32	4	EO		C25	5	E		32	4	EO		32	3	EO		32	3	EO	
11	2	OE						16	3	OE		C20	6	E		16	3	OE		16	2	OE		16	2	OE	
14	2	OE						20	3	OE		C20	6	E		20	3	OE		20	2	OE		20	2	OE	
32	5	OE						56	6	OE		C50	6	E		56	6	OE		56	5	OE		56	5	OE	
19	4	OE		32	4	OE		48	5	OE		C32	5	E		48	5	OE		48	4	OE		48	4	OE	
8,5	2	OE						12	3	OE		C20	5	E		12	3	OE		12	2	OE		12	2	OE	
48	7	EO						60	7	EO	M	C56	8	E		60	7	EO	M	60	5	EO	M	60	5	EO	M
48	7	EO						60	7	EO	M	C56	8	E		60	7	EO	M	60	5	EO	M	60	5	EO	M
20	2	OE						36	3	OE		C40	3	E		36	3	OE		36	2	OE		36	2	OE	
								31	3	OE		C40	3	E		31	3	OE		31	2	OE		31	2	OE	
								31	3	OE		C40	3	E		31	3	OE		31	2	OE		31	2	OE	
80	12	EO						100	16	EO		C100	20	E		100	16	EO		100	12	EO		100	12	EO	

Cutting data for solid carbide drills without internal cooling

Material group	= Cutting data for wet machining = Dry machining is possible, cutting data must be selected from Walter GPS E = Emulsion O = Oil M = MQL L = Dry v _c = Cutting speed VCRR = v _c rating chart from page B-122 VRR = Feed rating chart from page B-124			Drilling depth		3 x D _c								
				Designation		K3279XPL				A3279XPL A3879XPL				
				Type		X-treme Step 90				X-treme				
				Dimensions		Walter standard				DIN 6537 K				
Workpiece material			Ø range (mm)		3,30 – 14,50				3,00 – 20,00					
			Cutting tool material		K30F				K30F					
			Coating		XPL				XPL					
			Page		B-76				B-26 / B-50					
Structure of main material groups and code letters			Brinell hardness HB	Tensile strength R _m N/mm ²	Machining group ¹									
						v _c	VRR							
P	Non-alloyed steel	C ≤ 0.25%	annealed	125	428	P1	110	12	EO	ML	110	12	EO	ML
		C > 0.25... ≤ 0.55%	annealed	190	639	P2	120	12	EO	ML	120	12	EO	ML
		C > 0.25... ≤ 0.55%	tempered	210	708	P3	110	12	EO	ML	110	12	EO	ML
		C > 0.55%	annealed	190	639	P4	120	12	EO	ML	120	12	EO	ML
		C > 0.55%	tempered	300	1013	P5	95	10	EO	ML	95	10	EO	ML
	Low-alloyed steel	machining steel (short-chipping)	annealed	220	745	P6	110	12	EO	ML	110	12	EO	ML
			annealed	175	591	P7	120	12	EO	ML	120	12	EO	ML
			tempered	300	1013	P8	95	10	EO	ML	95	10	EO	ML
			tempered	380	1282	P9	63	7	OE		63	7	OE	
			tempered	430	1477	P10	48	5	OE		48	5	OE	
		High-alloyed steel and high-alloyed tool steel	annealed	200	675	P11	63	9	EO		63	9	EO	
			hardened and tempered	300	1013	P12	80	9	EO		80	9	EO	
			hardened and tempered	400	1361	P13	48	5	OE		48	5	OE	
		Stainless steel	ferritic/martensitic, annealed	200	675	P14	63	9	EO		63	9	EO	
	martensitic, tempered		330	1114	P15	40	7	EO		40	7	EO		
M	Stainless steel	austenitic, quench hardened	200	675	M1									
		austenitic, precipitation hardened (PH)	300	1013	M2	53	6	EO		53	6	EO		
		austenitic/ferritic, duplex	230	778	M3									
K	Malleable cast iron	ferritic	200	675	K1	90	16	EO	ML	90	16	EO	ML	
		pearlitic	260	867	K2	90	16	EO	ML	90	16	EO	ML	
	Grey cast iron	low tensile strength	180	602	K3	110	16	EO	ML	110	16	EO	ML	
		high tensile strength/austenitic	245	825	K4	95	16	EO	ML	95	16	EO	ML	
	Cast iron with spheroidal graphite	ferritic	155	518	K5	110	16	EO	ML	110	16	EO	ML	
		pearlitic	265	885	K6	90	16	EO	ML	90	16	EO	ML	
GGV (CGI)		200	675	K7	100	16	EO	ML	100	16	EO	ML		
N	Aluminium wrought alloys	cannot be hardened	30	–	N1	260	10	EO		260	10	EO		
		hardenable, hardened	100	343	N2	260	10	EO		260	10	EO		
	Cast aluminium alloys	≤ 12% Si, cannot be hardened	75	260	N3	240	16	EO		240	16	EO		
		≤ 12% Si, hardenable, hardened	90	314	N4	210	16	EO		210	16	EO		
		> 12% Si, cannot be hardened	130	447	N5	170	12	EO		170	12	EO		
	Magnesium alloys		70	250	N6									
		non-alloyed, electrolytic copper	100	343	N7	200	7	EO	M	200	7	EO	M	
Copper and copper alloys (bronze/brass)	brass, bronze, red brass	90	314	N8	170	12	EO		170	12	EO			
	Cu-alloys, short-chipping	110	382	N9	190	16	EO	ML	190	16	EO	ML		
	high-strength, Ampco	300	1013	N10	67	5	EO		67	5	EO			
S	Heat-resistant alloys	Fe-based	annealed	200	675	S1								
			hardened	280	943	S2								
		Ni or Co base	annealed	250	839	S3								
			hardened	350	1177	S4								
			cast	320	1076	S5								
	Titanium alloys	pure titanium	200	675	S6	42	5	OE		42	5	OE		
		α and β alloys, hardened	375	1262	S7	36	4	OE		36	4	OE		
β alloys		410	1396	S8										
Tungsten alloys		300	1013	S9	67	5	EO		67	5	EO			
Molybdenum alloys		300	1013	S10	67	5	EO		67	5	EO			
H	Hardened steel	hardened and tempered	50 HRC	–	H1	34	4	OE		34	4	OE		
		hardened and tempered	55 HRC	–	H2	26	3	OE		26	3	OE		
		hardened and tempered	60 HRC	–	H3									
	Hardened cast iron	hardened and tempered	55 HRC	–	H4	26	3	OE		26	3	OE		
O	Thermoplasts	without abrasive fillers			O1	95	16	EO		95	16	EO		
	Thermosetting plastics	without abrasive fillers			O2									
	Plastic, glass fibre reinforced	GFRP			O3									
	Plastic, carbon fibre reinforced	CFRP			O4									
	Plastic, aramid fibre reinforced	AFRP			O5									
	Graphite (technical)		80 Shore			O6								

¹ The classification of the machining groups can be found in the Walter General catalogue 2012 from page H 8 onwards.

* The pages indicated in italics refer to the Walter General catalogue 2012.

Cutting data for solid carbide drills without internal cooling

= Cutting data for wet machining = Dry machining is possible, cutting data must be selected from Walter GPS E = Emulsion O = Oil M = MQL L = Dry v _c = Cutting speed VCRR = v _c rating chart from page B-122 VRR = Feed rating chart from page B-124			Drilling depth			5 x D _c									
			Designation			A3378TML			A3162						
Type			Alpha [®] 2 Plus Micro			ESU									
Dimensions			Walter standard			DIN 1899									
Ø range (mm)			0,50 – 2,95			0,10 – 1,45									
Cutting tool material			K30F			K30F									
Coating			TML			uncoated									
Page			<i>B 79*</i>			<i>B 59*</i>									
Material group	Structure of main material groups and code letters		Brinell hardness HB	Tensile strength R _m N/mm ²	Machining group ¹										
	Workpiece material					VCRR	VRR	VCRR	VRR						
P	Non-alloyed steel	C ≤ 0.25%	annealed	125	428	P1	C100	16	EO	ML	C80	5	EO		
		C > 0.25... ≤ 0.55%	annealed	190	639	P2	C100	16	EO	ML	C80	6	EO		
		C > 0.25... ≤ 0.55%	tempered	210	708	P3	C90	16	EO	ML	C71	6	EO		
		C > 0.55%	annealed	190	639	P4	C100	16	EO	ML	C80	6	EO		
		C > 0.55%	tempered	300	1013	P5	C67	12	EO	ML	C53	5	EO		
	Low-alloyed steel	machining steel (short-chipping)		annealed	220	745	P6	C100	20	EO	ML	C80	6	EO	
				annealed	175	591	P7	C100	16	EO	ML	C80	6	EO	
				tempered	300	1013	P8	C67	12	EO	ML	C53	5	EO	
				tempered	380	1282	P9	C45	7	OE		C32	4	OE	
	High-alloyed steel and high-alloyed tool steel			tempered	430	1477	P10	C40	6	OE		C25	3	OE	
				annealed	200	675	P11	C50	10	EO		C32	4	EO	
				hardened and tempered	300	1013	P12	C50	8	EO		C40	4	EO	
	Stainless steel			hardened and tempered	400	1361	P13	C40	6	OE		C25	3	OE	
				ferritic/martensitic, annealed	200	675	P14	C50	10	EO		C32	4	EO	
				martensitic, tempered	330	1114	P15					C16	3	EO	
M	Stainless steel	austenitic, quench hardened		200	675	M1					C16	3	EO		
		austenitic, precipitation hardened (PH)		300	1013	M2	C42	5	EO			C25	3	EO	
		austenitic/ferritic, duplex		230	778	M3									
K	Malleable cast iron	ferritic		200	675	K1	C80	20	EO	ML	C63	6	EO		
		pearlitic		260	867	K2	C63	20	EO	ML	C50	4	EO		
	Grey cast iron	low tensile strength		180	602	K3	C100	20	EO	ML	C80	7	EO		
		high tensile strength/austenitic		245	825	K4	C80	20	EO	ML	C63	6	EO		
	Cast iron with spheroidal graphite	ferritic		155	518	K5	C80	20	EO		C63	6	EO		
		pearlitic		265	885	K6	C63	20	EO	ML	C50	4	EO		
GGV (CGI)				200	675	K7	C71	20	EO	ML	C56	5	EO		
N	Aluminium wrought alloys	cannot be hardened		30	–	N1	C125	16	OE		C200	9	EO	M	
		hardenable, hardened		100	343	N2	C125	16	OE		C200	9	EO	M	
	Cast aluminium alloys	≤ 12% Si, cannot be hardened		75	260	N3	C125	20	OE		C160	9	EO	M	
		≤ 12% Si, hardenable, hardened		90	314	N4	C125	20	OE		C125	9	EO	M	
		> 12% Si, cannot be hardened		130	447	N5	C125	20	OE		C80	8	EO		
	Magnesium alloys				70	250	N6				C160	9		ML	
Copper and copper alloys (bronze/brass)	non-alloyed, electrolytic copper		100	343	N7	C125	10	OE	M	C125	6	EO			
	brass, bronze, red brass		90	314	N8	C100	12	OE		C100	8	EO			
	Cu-alloys, short-chipping		110	382	N9	C100	20	OE	ML	C100	8	EO	ML		
	high-strength, Ampco		300	1013	N10	C67	12	EO	ML	C53	5	EO			
S	Heat-resistant alloys	Fe-based		200	675	S1					C16	3	EO		
				hardened	280	943	S2					C12	2	OE	
		Ni or Co base		250	839	S3						C12	2	OE	
				hardened	350	1177	S4								
				cast	320	1076	S5								
	Titanium alloys		pure titanium	200	675	S6	C50	9	OE		C25	3	OE		
		α and β alloys, hardened	375	1262	S7	C40	8	OE		C20	2	OE			
Tungsten alloys				410	1396	S8									
Molybdenum alloys				300	1013	S9	C67	12	EO		C53	5	EO		
				300	1013	S10	C67	12	EO		C53	5	EO		
H	Hardened steel	hardened and tempered		50 HRC	–	H1	C25	3	OE						
				55 HRC	–	H2									
				60 HRC	–	H3									
	Hardened cast iron		hardened and tempered		55 HRC	–	H4								
O	Thermoplasts		without abrasive fillers			01	C100	20	OE		C32	12	EO		
	Thermosetting plastics		without abrasive fillers			02					C50	5	L		
	Plastic, glass fibre reinforced		GFRP			03					C50	5	L		
	Plastic, carbon fibre reinforced		CFRP			04					C50	5	L		
	Plastic, aramid fibre reinforced		AFRP			05					C50	5	L		
	Graphite (technical)				80 Shore		06				C50	5	L		

¹ The classification of the machining groups can be found in the Walter General catalogue 2012 from page H 8 onwards.

* The pages indicated in italics refer to the Walter General catalogue 2012.

The specified cutting data are average recommended values.
For special applications, adjustment is recommended.

		5 x D _c				8 x D _c				3 x D _c – Carbide-tipped				NC spot drill																	
		A3379XPL A3979XPL		A3367 A3967		A6478TML		A1276TFL		A1263		A2971		A5971		A1174 A1174C															
		X-treme		BSX		Alpha® 2 Plus Micro		Alpha® 22		N		HM		HM		NC spot drill															
		DIN 6537 L		DIN 6537 L		Walter standard		DIN 338		DIN 338		DIN 8037		DIN 8041		Walter standard															
		3,00 – 25,00		3,00 – 16,00		0,50 – 2,95		3,00 – 12,00		0,60 – 12,00		3,00 – 16,00		8,00 – 32,00		3,00 – 20,00															
		K30F		K30F		K30F		K30F		K30F		K10/20		K10/20		K30F															
		XPL		uncoated		TML		TFL		uncoated		uncoated		uncoated		uncoated															
		B-37 / B-58		B 77* / B 110*		B 119*		B 57*		B 55*		B 58*		B 116*		B 53* / B 54*															
		v _c VRR		v _c VRR		VCCR VRR		v _c VRR		v _c VRR		v _c VRR		v _c VRR		v _c VRR															
100	10	EO	ML			C100	16	EO	ML	75	8	EO	ML																		
105	10	EO	ML			C100	16	EO	ML	71	8	EO	ML																		
100	10	EO	ML			C90	16	EO	ML	71	8	EO	ML																		
105	10	EO	ML			C100	16	EO	ML	71	8	EO	ML																		
85	8	EO	ML			C67	12	EO	ML			EO	ML																		
100	12	EO	ML			C100	20	EO	ML	75	9	EO	ML																		
105	10	EO	ML			C100	16	EO	ML	71	8	EO	ML																		
85	8	EO	ML			C67	12	EO	ML			EO	ML																		
56	6	OE				C45	7	OE																							
38	4	OE				C40	6	OE				23	2	OE		23	2	OE													
53	7	EO				C50	10	EO		53	7	EO																			
71	7	EO				C50	8	EO																							
38	4	OE				C40	6	OE				25	2	OE		25	2	OE													
53	7	EO				C50	10	EO		53	7	EO																			
36	6	EO								38	5	EO																			
48	6	EO				C42	5	EO																							
75	16	EO	ML	75	16	EO	C80	20	EO	ML	67	12	EO	ML	36	6	EO	26	6	EO	26	6	EO	26	6	EO	45	8	EO		
75	16	EO	ML	60	16	EO	C63	20	EO	ML	56	10	EO	ML	28	5	EO	21	4	OE	21	4	OE	21	4	OE	34	6	EO		
95	16	EO	ML	90	16	EO	C100	20	EO	ML	80	12	EO	ML	45	6	EO	32	6	EO	32	6	EO	32	6	EO	56	8	EO		
80	16	EO	ML	75	16	EO	C80	20	EO	ML	67	12	EO	ML	36	6	EO	26	6	EO	26	6	EO	26	6	EO	45	8	EO		
95	16	EO	ML	75	16	EO	C80	20	EO	ML	67	12	EO	ML	36	6	EO	26	6	EO	26	6	EO	26	6	EO	45	8	EO		
75	12	EO	ML	60	16	EO	C63	20	EO	ML	56	10	EO	ML	28	5	EO	16	4	EO	16	4	EO	16	4	EO	34	6	EO		
85	16	EO	ML	67	16	EO	C71	20	EO	ML	63	12	EO	ML	32	6	EO	21	5	EO	21	5	EO	21	5	EO	40	7	EO		
260	10	EO		300	10	EO	M	C125	16	OE				200	9	EO	M									220	10	EO	M		
260	10	EO		300	10	EO	M	C125	16	OE				200	9	EO	M									220	10	EO	M		
240	16	EO		200	16	EO	M	C125	20	OE	220	12	EO		150	9	EO	M							170	10	EO	M			
210	16	EO		180	16	EO	M	C125	20	OE	200	12	EO		130	9	EO	M							150	10	EO	M			
170	12	EO		140	16	EO		C125	20	OE	160	12	EO		90	8	EO								100	9	EO				
				180	16	EO	ML							170	8	ML									210	10	ML				
170	6	EO	M	190	8	EO	M	C125	10	OE	M	140	5	EO	M	110	5	EO							140	7	EO				
140	10	EO		140	12	EO		C100	12	OE		120	9	EO		80	7	EO							100	9	EO				
190	16	EO	ML	150	16	EO	ML	C100	20	OE	ML	150	16	EO	ML	90	9	EO	ML	67	8	EO	ML	67	8	EO	ML	110	12	EO	ML
67	5	EO						C67	12	EO	ML							25	2	OE		25	2	OE		50	6	EO	ML		
																										7	3	OE			
																										7	3	OE			
																										7	3	OE			
34	5	OE		30	4	OE		C50	9	OE		34	5	OE											25	3	OE				
30	4	OE		24	3	OE		C40	8	OE		28	4	OE											17	2	OE				
67	5	EO						C67	12	EO		67	8	EO				25	2	OE		25	2	OE							
67	5	EO						C67	12	EO		67	8	EO				25	2	OE		25	2	OE							
28	3	OE						C25	3	OE								21	2	OE		21	2	OE							
24	3	OE																12	2	OE		12	2	OE							
24	3	OE																12	2	OE		12	2	OE							
95	16	EO		40	16	EO		C100	20	OE				36	12	EO									40	12	EO				
				50	8	L								67	5	L	45	5	EO	L	45	5	EO	L	67	5	L				
				30	8	L								30	5	L	35	4	L	35	4	L	35	4	L	30	5	L			
				20	8	L								20	5	L									20	5	L				
				67	8	L								67	5	L									67	5	L				
				20	8	L								20	5	L	25	3	L	25	3	L	25	3	L	20	5	L			

Cutting data for centre drills

= Cutting data for wet machining = Dry machining is possible, cutting data must be selected from Walter GPS E = Emulsion O = Oil M = MQL L = Dry v _c = Cutting speed V _{RRR} = v _c rating chart from page B-122 VRR = Feed rating chart from page B-124			Dimensions			DIN 333								
			Designation			K1161		K1161XPL						
			Form			A		A						
			Type			VHM		VHM						
			Ø range (mm)			0,50 – 6,30		0,50 – 6,30						
			Cutting tool material			K10/20		K10/20						
			Coating			uncoated		XPL						
			Page			B-84		B-85						
Material group	Structure of main material groups and code letters		Brinell hardness HB	Tensile strength R _m N/mm ²	Machining group ¹									
	Workpiece material					v _c	VRR	v _c	VRR					
P	Non-alloyed steel	C ≤ 0.25%	annealed	125	428	P1	48	6	E O M L	72	6	E O M L		
		C > 0.25... ≤ 0.55%	annealed	190	639	P2	45	6	E O M L	68	6	E O M L		
		C > 0.25... ≤ 0.55%	tempered	210	708	P3	42	6	E O M L	63	6	E O M L		
		C > 0.55%	annealed	190	639	P4	45	6	E O M L	68	6	E O M L		
		C > 0.55%	tempered	300	1013	P5	32	5	E O M L	48	5	E O M L		
	Low-alloyed steel	machining steel (short-chipping)		annealed	220	745	P6	48	6	E O M L	72	6	E O M L	
		annealed			175	591	P7	45	6	E O M L	68	6	E O M L	
			tempered		300	1013	P8	32	5	E O M L	48	5	E O M L	
			tempered		380	1282	P9	21	3	O E	32	3	O E	
			tempered		430	1477	P10	16	2	O E	24	2	O E	
		High-alloyed steel and high-alloyed tool steel	annealed			200	675	P11	28	4	E O	42	4	E O
			hardened and tempered			300	1013	P12	25	4	E O	38	4	E O
			hardened and tempered			400	1361	P13	16	2	O E	24	2	O E
		Stainless steel	ferritic/martensitic, annealed			200	675	P14	28	4	E O	42	4	E O
			martensitic, tempered			330	1114	P15	21	3	E O	32	3	E O
M	Stainless steel	austenitic, quench hardened		200	675	M1								
		austenitic, precipitation hardened (PH)		300	1013	M2	21	3	E O	21	3	E O		
		austenitic/ferritic, duplex		230	778	M3								
K	Malleable cast iron	ferritic		200	675	K1	40	8	E O M L	72	8	E O M L		
		pearlitic		260	867	K2	32	7	E O M L	58	7	E O M L		
	Grey cast iron	low tensile strength		180	602	K3	48	8	E O M L	86	8	E O M L		
		high tensile strength/austenitic		245	825	K4	40	8	E O M L	72	8	E O M L		
	Cast iron with spheroidal graphite	ferritic		155	518	K5	40	8	E O M L	72	8	E O M L		
		pearlitic		265	885	K6	32	7	E O M L	58	7	E O M L		
	GGV (CGI)			200	675	K7	36	8	E O M L	65	8	E O M L		
N	Aluminium wrought alloys	cannot be hardened		30	–	N1	130	5	E O	130	5	E O		
		hardenable, hardened		100	343	N2	130	5	E O	130	5	E O		
		≤ 12% Si, cannot be hardened		75	260	N3	105	7	E O	105	7	E O		
	Cast aluminium alloys	≤ 12% Si, hardenable, hardened		90	314	N4	90	7	E O	90	7	E O		
		> 12% Si, cannot be hardened		130	447	N5	71	7	E O	71	7	E O		
	Magnesium alloys				70	250	N6	90	7	M L	90	7	M L	
	Copper and copper alloys (bronze/brass)	non-alloyed, electrolytic copper			100	343	N7	90	3	E O M	90	3	E O M	
brass, bronze, red brass			90	314	N8	75	6	E O	75	6	E O			
Cu-alloys, short-chipping			110	382	N9	80	8	E O M L	80	8	E O M L			
high-strength, Ampco			300	1013	N10	32	5	E O	48	5	E O			
S	Heat-resistant alloys	Fe-based	annealed	200	675	S1	22	2	O E	33	2	O E		
			hardened	280	943	S2	15	2	O E	15	2	O E		
		Ni or Co base	annealed	250	839	S3	18	2	O E	27	2	O E		
			hardened	350	1177	S4	10	1	O E	10	1	O E		
			cast	320	1076	S5	12	1	O E	12	1	O E		
	Titanium alloys	pure titanium			200	675	S6							
		α and β alloys, hardened			375	1262	S7							
		β alloys			410	1396	S8							
Tungsten alloys				300	1013	S9	32	5	E O	48	5	E O		
Molybdenum alloys				300	1013	S10	32	5	E O	48	5	E O		
H	Hardened steel	hardened and tempered		50 HRC	–	H1	12,5	2	O E	19	2	O E		
		hardened and tempered		55 HRC	–	H2								
		hardened and tempered		60 HRC	–	H3								
	Hardened cast iron		hardened and tempered		55 HRC	–	H4							
O	Thermoplasts		without abrasive fillers			01	45	7	E O	45	7	E O		
	Thermosetting plastics		without abrasive fillers			02	45	7	E O	45	7	E O		
	Plastic, glass fibre reinforced		GFRP			03	35	6	L	35	6	L		
	Plastic, carbon fibre reinforced		CFRP			04	25	5	L	25	5	L		
	Plastic, aramid fibre reinforced		AFRP			05	45	7	L	45	7	L		
	Graphite (technical)				80 Shore		06	25	5	L	25	5	L	

¹ The classification of the machining groups can be found in the Walter General catalogue 2012 from page H 8 onwards.

* The pages indicated in italics refer to the Walter General catalogue 2012.

The specified cutting data are average recommended values.
For special applications, adjustment is recommended.

DIN 333																													
K1111TiN			K1111			K1112			K1131			K1113TiN			K1113			K1114			K1215								
A			A			A			A			R			R			R			B								
-			-			with flat			left-hand			-			-			with flat			-								
1,00 – 5,00			0,50 – 12,50			1,60 – 5,00			0,50 – 6,30			1,00 – 5,00			0,50 – 12,50			1,60 – 5,00			1,00 – 10,00								
HSS			HSS			HSS			HSS			HSS			HSS			HSS			HSS								
TiN			uncoated			uncoated			uncoated			TiN			uncoated			uncoated			uncoated								
B 292*			B 292*			B 293*			B 297*			B 295*			B 294*			B 296*			B 299*								
v _c	VRR		v _c	VRR		v _c	VRR		v _c	VRR		v _c	VRR		v _c	VRR		v _c	VRR		v _c	VRR		v _c	VRR		v _c	VRR	
38	8	EO	30	7	EO	30	7	EO	30	7	EO	38	8	EO	30	7	EO	30	7	EO	30	7	EO	30	7	EO	30	7	EO
38	9	EO	30	8	EO	30	8	EO	30	8	EO	38	9	EO	30	8	EO	30	8	EO	30	8	EO	30	8	EO	30	8	EO
36	9	EO	28	8	EO	28	8	EO	28	8	EO	36	9	EO	28	8	EO	28	8	EO	28	8	EO	28	8	EO	28	8	EO
38	9	EO	30	8	EO	30	8	EO	30	8	EO	38	9	EO	30	8	EO	30	8	EO	30	8	EO	30	8	EO	30	8	EO
28	8	EO	20	7	EO	20	7	EO	20	7	EO	28	8	EO	20	7	EO	20	7	EO	20	7	EO	20	7	EO	20	7	EO
38	9	EO	30	8	EO	30	8	EO	30	8	EO	38	9	EO	30	8	EO	30	8	EO	30	8	EO	30	8	EO	30	8	EO
38	9	EO	30	8	EO	30	8	EO	30	8	EO	38	9	EO	30	8	EO	30	8	EO	30	8	EO	30	8	EO	30	8	EO
28	8	EO	20	7	EO	20	7	EO	20	7	EO	28	8	EO	20	7	EO	20	7	EO	20	7	EO	20	7	EO	20	7	EO
13	6	EO	11	6	OE	11	6	OE	11	6	OE	13	6	EO	11	6	OE	11	6	OE	11	6	OE	11	6	OE	11	6	OE
			7	5	OE	7	5	OE	7	5	OE				7	5	OE	7	5	OE	7	5	OE	7	5	OE	7	5	OE
9	4	EO	8	4	EO	8	4	EO	8	4	EO	9	4	EO	8	4	EO	8	4	EO	8	4	EO	8	4	EO	8	4	EO
21	6	EO	14	6	EO	14	6	EO	14	6	EO	21	6	EO	14	6	EO	14	6	EO	14	6	EO	14	6	EO	14	6	EO
			7	5	OE	7	5	OE	7	5	OE				7	5	OE	7	5	OE	7	5	OE	7	5	OE	7	5	OE
9	4	EO	8	4	EO	8	4	EO	8	4	EO	9	4	EO	8	4	EO	8	4	EO	8	4	EO	8	4	EO	8	4	EO
			7	4	EO	7	4	EO	7	4	EO				7	4	EO	7	4	EO	7	4	EO	7	4	EO	7	4	EO
7	4	OE	6	3	OE	6	3	OE	6	3	OE	7	4	OE	6	3	OE	6	3	OE	6	3	OE	6	3	OE	6	3	OE
13	5	OE	8	5	OE	8	5	OE	8	5	OE	13	5	OE	8	5	OE	8	5	OE	8	5	OE	8	5	OE	8	5	OE
6	4	OE	5	3	OE	5	3	OE	5	3	OE	6	4	OE	5	3	OE	5	3	OE	5	3	OE	5	3	OE	5	3	OE
34	12	EO	22	12	EO	22	12	EO	22	12	EO	34	12	EO	22	12	EO	22	12	EO	22	12	EO	22	12	EO	22	12	EO
26	10	EO	17	10	EO	17	10	EO	17	10	EO	26	10	EO	17	10	EO	17	10	EO	17	10	EO	17	10	EO	17	10	EO
42	12	EO	28	12	EO	28	12	EO	28	12	EO	42	12	EO	28	12	EO	28	12	EO	28	12	EO	28	12	EO	28	12	EO
34	12	EO	22	12	EO	22	12	EO	22	12	EO	34	12	EO	22	12	EO	22	12	EO	22	12	EO	22	12	EO	22	12	EO
34	12	EO	22	12	EO	22	12	EO	22	12	EO	34	12	EO	22	12	EO	22	12	EO	22	12	EO	22	12	EO	22	12	EO
26	10	EO	17	10	EO	17	10	EO	17	10	EO	26	10	EO	17	10	EO	17	10	EO	17	10	EO	17	10	EO	17	10	EO
30	12	EO	20	12	EO	20	12	EO	20	12	EO	30	12	EO	20	12	EO	20	12	EO	20	12	EO	20	12	EO	20	12	EO
79	12	EO	63	12	EO	63	12	EO	63	12	EO	79	12	EO	63	12	EO	63	12	EO	63	12	EO	63	12	EO	63	12	EO
79	12	EO	63	12	EO	63	12	EO	63	12	EO	79	12	EO	63	12	EO	63	12	EO	63	12	EO	63	12	EO	63	12	EO
50	12	EO	40	12	EO	40	12	EO	40	12	EO	50	12	EO	40	12	EO	40	12	EO	40	12	EO	40	12	EO	40	12	EO
35	10	EO	28	10	EO	28	10	EO	28	10	EO	35	10	EO	28	10	EO	28	10	EO	28	10	EO	28	10	EO	28	10	EO
35	10	ML	28	10	ML	28	10	ML	28	10	ML	35	10	ML	28	10	ML	28	10	ML	28	10	ML	28	10	ML	28	10	ML
56	5	EO	45	5	EO	45	5	EO	45	5	EO	56	5	EO	45	5	EO	45	5	EO	45	5	EO	45	5	EO	45	5	EO
			36	10	EO	36	10	EO	36	10	EO				36	10	EO	36	10	EO	36	10	EO	36	10	EO	36	10	EO
71	12	EO ML	63	12	EO ML	63	12	EO ML	63	12	EO ML	71	12	EO ML	63	12	EO ML	63	12	EO ML	63	12	EO ML	63	12	EO ML	63	12	EO ML
21	6	EO	14	6	EO	14	6	EO	14	6	EO	21	6	EO	14	6	EO	14	6	EO	14	6	EO	14	6	EO	14	6	EO
7	4	OE	6	3	OE	6	3	OE	6	3	OE	7	4	OE	6	3	OE	6	3	OE	6	3	OE	6	3	OE	6	3	OE
4	3	OE	4	3	OE	6	3	OE	4	3	OE	4	3	OE	4	3	OE	4	3	OE	4	3	OE	4	3	OE	4	3	OE
			6	3	OE	6	3	OE	6	3	OE				6	3	OE	6	3	OE	6	3	OE	6	3	OE	6	3	OE
8	4	EO	8	4	EO	8	4	EO	8	4	EO	8	4	EO	8	4	EO	8	4	EO	8	4	EO	8	4	EO	8	4	EO
6	4	OE	6	4	OE	6	4	OE	6	4	OE	6	4	OE	6	4	OE	6	4	OE	6	4	OE	6	4	OE	6	4	OE
21	6	EO	14	6	EO	14	6	EO	14	6	EO	21	6	EO	14	6	EO	14	6	EO	14	6	EO	14	6	EO	14	6	EO
21	6	EO	14	6	EO	14	6	EO	14	6	EO	21	6	EO	14	6	EO	14	6	EO	14	6	EO	14	6	EO	14	6	EO
34	8	L	22	7	L	22	7	L	22	7	L	34	8	L	22	7	L	22	7	L	22	7	L	22	7	L	22	7	L
34	8	L	22	7	L	22	7	L	22	7	L	34	8	L	22	7	L	22	7	L	22	7	L	22	7	L	22	7	L

Cutting data for centre drills

= Cutting data for wet machining = Dry machining is possible, cutting data must be selected from Walter GPS E = Emulsion O = Oil M = MQL L = Dry v _c = Cutting speed V _{CRR} = v _c rating chart from page B-122 VRR = Feed rating chart from page B-124				Dimensions			Walter standard			
				Designation			K1313			
Form				R						
Ø range (mm)				1,00 – 4,00						
Cutting tool material				HSS						
Coating				uncoated						
Page				B 301*						
Material group	Structure of main material groups and code letters			Brinell hardness HB	Tensile strength R _m N/mm ²	Machining group ¹				
	Workpiece material									
P	Non-alloyed steel	C ≤ 0.25%	annealed	125	428	P1	30	7	E O	
		C > 0.25... ≤ 0.55%	annealed	190	639	P2	30	8	E O	
		C > 0.25... ≤ 0.55%	tempered	210	708	P3	28	8	E O	
		C > 0.55%	annealed	190	639	P4	30	8	E O	
		C > 0.55%	tempered	300	1013	P5	20	7	E O	
	Low-alloyed steel	machining steel (short-chipping)			220	745	P6	30	8	E O
		annealed			175	591	P7	30	8	E O
		tempered			300	1013	P8	20	7	E O
		tempered			380	1282	P9	11	6	O E
		tempered			430	1477	P10	7	5	O E
	High-alloyed steel and high-alloyed tool steel	annealed			200	675	P11	8	4	E O
		hardened and tempered			300	1013	P12	14	6	E O
		hardened and tempered			400	1361	P13	7	5	O E
	Stainless steel	ferritic/martensitic, annealed			200	675	P14	8	4	E O
		martensitic, tempered			330	1114	P15	7	4	E O
M	Stainless steel	austenitic, quench hardened			200	675	M1	6	3	O E
		austenitic, precipitation hardened (PH)			300	1013	M2	8	5	O E
		austenitic/ferritic, duplex			230	778	M3	4,8	3	O E
K	Malleable cast iron	Ferritic			200	675	K1	22	12	E O
		pearlitic			260	867	K2	17	10	E O
	Grey cast iron	low tensile strength			180	602	K3	28	12	E O
		high tensile strength/austenitic			245	825	K4	22	12	E O
	Cast iron with spheroidal graphite	ferritic			155	518	K5	22	12	E O
		pearlitic			265	885	K6	17	10	E O
GGV (CGI)			200	675	K7	20	12	E O		
N	Aluminium wrought alloys	cannot be hardened			30	–	N1	63	12	E O
		hardenable, hardened			100	343	N2	63	12	E O
	Cast aluminium alloys	≤ 12% Si, cannot be hardened			75	260	N3	40	12	E O
		≤ 12% Si, hardenable, hardened			90	314	N4	28	10	E O
		> 12% Si, cannot be hardened			130	447	N5			
	Magnesium alloys			70	250	N6	28	10	M L	
	Copper and copper alloys (bronze/brass)	non-alloyed, electrolytic copper			100	343	N7	45	5	E O
brass, bronze, red brass			90	314	N8	36	10	E O		
Cu-alloys, short-chipping			110	382	N9	63	12	E O M L		
high-strength, Ampco			300	1013	N10	14	6	E O		
S	Heat-resistant alloys	Fe-based		annealed	200	675	S1	6	3	O E
				hardened	280	943	S2	4	3	O E
		Ni or Co base		annealed	250	839	S3	6	3	O E
				hardened	350	1177	S4			
				cast	320	1076	S5			
	Titanium alloys	pure titanium		200	675	S6	8	4	E O	
		α and β alloys, hardened		375	1262	S7	6	4	O E	
		β alloys		410	1396	S8				
	Tungsten alloys			300	1013	S9	14	6	E O	
	Molybdenum alloys			300	1013	S10	14	6	E O	
H	Hardened steel	hardened and tempered			50 HRC	–	H1			
		hardened and tempered			55 HRC	–	H2			
		hardened and tempered			60 HRC	–	H3			
	Hardened cast iron			55 HRC	–	H4				
O	Thermoplasts					O1	38	12	E O	
	Thermosetting plastics					O2	22	7	L	
	Plastic, glass fibre reinforced					O3				
	Plastic, carbon fibre reinforced					O4				
	Plastic, aramid fibre reinforced					O5	22	7	L	
	Graphite (technical)			80 Shore		O6				

¹ The classification of the machining groups can be found in the Walter General catalogue 2012 from page H 8 onwards.

* The pages indicated in italics refer to the Walter General catalogue 2012.

The specified cutting data are average recommended values.
For special applications, adjustment is recommended.

	Walter standard												ANSI B 94.11 M-1979			B.S. 328			Step centre drill								
	K1311			K1411S			K1411M			K1411L			K1811			K1911			K2511			K2513					
	A			A			A			A			A			A			60°			Radius					
	0,63 – 6,00			0,75 – 5,00			0,75 – 4,00			2,00 – 4,00			0,64 – 7,97			1,19 – 7,94			3,30 – 21,00			3,30 – 21,00					
	HSS			HSS			HSS			HSS			HSS			HSS			HSS			HSS					
	uncoated			uncoated			uncoated			uncoated			uncoated			uncoated			uncoated			uncoated					
	B 300*			B 304*			B 303*			B 302*			B 305*			B 306*			B 307*			B 308*					
	v _c	VRR		v _c	VRR		v _c	VRR		v _c	VRR		v _c	VRR		v _c	VRR		v _c	VRR		v _c	VRR				
30	7	EO		30	7	EO		30	7	EO		30	7	EO		30	7	EO		30	7	EO		30	7	EO	
30	8	EO		30	8	EO		30	8	EO		30	8	EO		30	8	EO		30	8	EO		30	8	EO	
28	8	EO		28	8	EO		28	8	EO		28	8	EO		28	8	EO		28	8	EO		28	8	EO	
30	8	EO		30	8	EO		30	8	EO		30	8	EO		30	8	EO		30	8	EO		30	8	EO	
20	7	EO		20	7	EO		20	7	EO		20	7	EO		20	7	EO		20	7	EO		20	7	EO	
30	8	EO		30	8	EO		30	8	EO		30	8	EO		30	8	EO		30	8	EO		30	8	EO	
30	8	EO		30	8	EO		30	8	EO		30	8	EO		30	8	EO		30	8	EO		30	8	EO	
20	7	EO		20	7	EO		20	7	EO		20	7	EO		20	7	EO		20	7	EO		20	7	EO	
11	6	OE		11	6	OE		11	6	OE		11	6	OE		11	6	OE		11	6	OE		11	6	OE	
7	5	OE		7	5	OE		7	5	OE		7	5	OE		7	5	OE		7	5	OE		7	5	OE	
8	4	EO		8	4	EO		8	4	EO		8	4	EO		8	4	EO		8	4	EO		8	4	EO	
14	6	EO		14	6	EO		14	6	EO		14	6	EO		14	6	EO		14	6	EO		14	6	EO	
7	5	OE		7	5	OE		7	5	OE		7	5	OE		7	5	OE		7	5	OE		7	5	OE	
8	4	EO		8	4	EO		8	4	EO		8	4	EO		8	4	EO		8	4	EO		8	4	EO	
7	4	EO		7	4	EO		7	4	EO		7	4	EO		7	4	EO		7	4	EO		7	4	EO	
6	3	OE		6	3	OE		6	3	OE		6	3	OE		6	3	OE		6	3	OE		6	3	OE	
8	5	OE		8	5	OE		8	5	OE		8	5	OE		8	5	OE		8	5	OE		8	5	OE	
4,8	3	OE		4,8	3	OE		4,8	3	OE		4,8	3	OE		5	3	OE		4,8	3	OE		4,8	3	OE	
22	12	EO		22	12	EO		22	12	EO		22	12	EO		22	12	EO		22	12	EO		22	12	EO	
17	10	EO		17	10	EO		17	10	EO		17	10	EO		17	10	EO		17	10	EO		17	10	EO	
28	12	EO		28	12	EO		28	12	EO		28	12	EO		28	12	EO		28	12	EO		28	12	EO	
22	12	EO		22	12	EO		22	12	EO		22	12	EO		22	12	EO		22	12	EO		22	12	EO	
22	12	EO		22	12	EO		22	12	EO		22	12	EO		22	12	EO		22	12	EO		22	12	EO	
17	10	EO		17	10	EO		17	10	EO		17	10	EO		17	10	EO		17	10	EO		17	10	EO	
20	12	EO		20	12	EO		20	12	EO		20	12	EO		20	12	EO		20	12	EO		20	12	EO	
63	12	EO		63	12	EO		63	12	EO		63	12	EO		63	12	EO		63	12	EO		63	12	EO	
63	12	EO		63	12	EO		63	12	EO		63	12	EO		63	12	EO		63	12	EO		63	12	EO	
40	12	EO		40	12	EO		40	12	EO		40	12	EO		40	12	EO		40	12	EO		40	12	EO	
28	10	EO		28	10	EO		28	10	EO		28	10	EO		28	10	EO		28	10	EO		28	10	EO	
28	10		ML	28	10		ML	28	10		ML	28	10		ML	28	10		ML	28	10		ML	28	10		ML
45	5	EO		45	5	EO		45	5	EO		45	5	EO		45	5	EO		45	5	EO		45	5	EO	
36	10	EO		36	10	EO		36	10	EO		36	10	EO		36	10	EO		36	10	EO		36	10	EO	
63	12	EO	ML	63	12	EO	ML	63	12	EO	ML	63	12	EO	ML	63	12	EO	ML	63	12	EO	ML	63	12	EO	ML
14	6	EO		14	6	EO		14	6	EO		14	6	EO		14	6	EO		14	6	EO		14	6	EO	
6	3	OE		6	3	OE		6	3	OE		6	3	OE		6	3	OE		6	3	OE		6	3	OE	
4	3	OE		4	3	OE		4	3	OE		4	3	OE		4	3	OE		4	3	OE		4	3	OE	
6	3	OE		6	3	OE		6	3	OE		6	3	OE		6	3	OE		6	3	OE		6	3	OE	
8	4	EO		8	4	EO		8	4	EO		8	4	EO		8	4	EO		8	4	EO		8	4	EO	
6	4	OE		6	4	OE		6	4	OE		6	4	OE		6	4	OE		6	4	OE		6	4	OE	
14	6	EO		14	6	EO		14	6	EO		14	6	EO		14	6	EO		14	6	EO		14	6	EO	
14	6	EO		14	6	EO		14	6	EO		14	6	EO		14	6	EO		14	6	EO		14	6	EO	
38	12	EO		38	12	EO		38	12	EO		38	12	EO		38	12	EO		38	12	EO		38	12	EO	
22	7		L	22	7		L	22	7		L	22	7		L	22	7		L	22	7		L	22	7		L
22	7		L	22	7		L	22	7		L	22	7		L	22	7		L	22	7		L	22	7		L

Cutting data for reamers

= Cutting data for wet machining = Dry machining is possible, cutting data must be selected from Walter GPS E = Emulsion O = Oil M = MQL L = Dry v_C = Cutting speed VRR = Feed rating chart from page B-125				Dimensions			Walter standard						
				Designation	F2482	F2482TMS	Form	–	–	Type	Straight flute	Straight flute	
Structure of main material groups and code letters				Ø range (mm)	3,97 – 20,00		3,97 – 20,00						
				Cutting tool material	K10F		K10F						
Workpiece material				Coating	uncoated		TMS						
				Page	B-98		B-100						
Material group				Brinell hardness HB	Tensile strength R _m N/mm ²	Machining group ¹							
				v _C	VRR								
P	Non-alloyed steel	C ≤ 0.25%	annealed	125	428	P1	45	8	O E	190	20	O E	
		C > 0.25... ≤ 0.55%	annealed	190	639	P2	40	8	O E	175	20	O E	
		C > 0.25... ≤ 0.55%	tempered	210	708	P3	40	8	O E	170	20	O E	
		C > 0.55%	annealed	190	639	P4	40	8	O E	175	20	O E	
		C > 0.55%	tempered	300	1013	P5	30	8	O E	130	20	O E	
	Low-alloyed steel	High-alloyed steel and high-alloyed tool steel	machining steel (short-chipping)	annealed	220	745	P6	45	8	O E	190	20	O E
			annealed	175	591	P7	40	8	O E	175	20	O E	
			tempered	300	1013	P8	30	8	O E	130	20	O E	
			tempered	380	1282	P9	20	8	O E	80	20	O E	
		Stainless steel	tempered	430	1477	P10	10	8	O E	50	20	O E	
			annealed	200	675	P11	25	8	O E	110	20	O E	
			hardened and tempered	300	1013	P12	20	8	O E	95	20	O E	
			hardened and tempered	400	1361	P13	15	8	O E	65	20	O E	
			ferritic/martensitic, annealed	200	675	P14	25	8	O E	110	20	O E	
	M	Stainless steel	martensitic, tempered	330	1114	P15	20	8	O E	80	20	O E	
austenitic, quench hardened			200	675	M1								
austenitic, precipitation hardened (PH)			300	1013	M2								
K	Malleable cast iron	austenitic/ferritic, duplex	230	778	M3								
		ferritic	200	675	K1	35	8	O E	120	20	O E		
	Grey cast iron	pearlitic	260	867	K2	30	8	O E	95	20	O E		
		low tensile strength	180	602	K3	45	8	O E	145	20	O E		
		high tensile strength/austenitic	245	825	K4	35	8	O E	120	20	O E		
	Cast iron with spheroidal graphite	ferritic	155	518	K5	35	8	O E	120	20	O E		
		pearlitic	265	885	K6	30	8	O E	95	20	O E		
GGV (CGI)		200	675	K7	35	8	O E	110	20	O E			
N	Aluminium wrought alloys	cannot be hardened	30	–	N1	115	8	O E					
		hardenable, hardened	100	343	N2	115	8	O E					
	Cast aluminium alloys	≤ 12% Si, cannot be hardened	75	260	N3	90	8	O E					
		≤ 12% Si, hardenable, hardened	90	314	N4	80	8	O E					
		> 12% Si, cannot be hardened	130	447	N5	65	8	O E					
	Magnesium alloys		70	250	N6	80	8	O					
	Copper and copper alloys (bronze/brass)	non-alloyed, electrolytic copper	100	343	N7	80	8	O E					
brass, bronze, red brass		90	314	N8	65	8	O E						
Cu-alloys, short-chipping		110	382	N9	70	8	O E						
high-strength, Ampco		300	1013	N10	20	8	O E						
S	Heat-resistant alloys	Fe-based	annealed	200	675	S1							
		hardened	280	943	S2								
		annealed	250	839	S3								
		Ni or Co base	hardened	350	1177	S4							
		cast	320	1076	S5								
	Titanium alloys	pure titanium	200	675	S6								
		α and β alloys, hardened	375	1262	S7								
		β alloys	410	1396	S8								
	Tungsten alloys		300	1013	S9								
	Molybdenum alloys		300	1013	S10								
H	Hardened steel	hardened and tempered	50 HRC	–	H1								
		hardened and tempered	55 HRC	–	H2								
		hardened and tempered	60 HRC	–	H3								
	Hardened cast iron	hardened and tempered	55 HRC	–	H4								
O	Thermoplasts	without abrasive fillers			O1	40	8	E					
	Thermosetting plastics	without abrasive fillers			O2	40	8	E					
	Plastic, glass fibre reinforced	GFRP			O3	30	8	E					
	Plastic, carbon fibre reinforced	CFRP			O4								
	Plastic, aramid fibre reinforced	AFRP			O5								
	Graphite (technical)		80 Shore			O6							

¹ The classification of the machining groups can be found in the Walter General catalogue 2012 from page H 8 onwards.

* The pages indicated in italics refer to the Walter General catalogue 2012.

The specified cutting data are average recommended values.
For special applications, adjustment is recommended.

Walter standard																							
F2481			F2481TMS			F2162			F2171			F4162			F4171								
Left-hand spiral			Left-hand spiral			Straight flute			Left-hand spiral			Straight flute			Left-hand spiral								
3,97 – 20,00			3,97 – 20,00			4,00 – 20,00			2,00 – 20,00			5,00 – 32,00			5,00 – 20,00								
K10F			K10F			K10			K10			K10			K10								
uncoated			TMS			uncoated			uncoated			uncoated			uncoated								
B-94			B-96			B-92			B-93			B 341*			B 342*								
vc		VRR		OE		vc		VRR		OE		vc		VRR		OE		vc		VRR		OE	
45	8	OE	190	20	OE	24	8	EO	24	8	EO	24	8	EO	24	8	EO	24	8	EO	24	8	EO
40	8	OE	175	20	OE	22	8	EO	22	8	EO	22	8	EO	22	8	EO	22	8	EO	22	8	EO
40	8	OE	170	20	OE	21	8	EO	21	8	EO	21	8	EO	21	8	EO	21	8	EO	21	8	EO
40	8	OE	175	20	OE	22	8	EO	22	8	EO	22	8	EO	22	8	EO	22	8	EO	22	8	EO
30	8	OE	130	20	OE	16	8	EO	16	8	EO	16	8	EO	16	8	EO	16	8	EO	16	8	EO
45	8	OE	190	20	OE	24	8	EO	24	8	EO	24	8	EO	24	8	EO	24	8	EO	24	8	EO
40	8	OE	175	20	OE	22	8	EO	22	8	EO	22	8	EO	22	8	EO	22	8	EO	22	8	EO
30	8	OE	130	20	OE	16	8	EO	16	8	EO	16	8	EO	16	8	EO	16	8	EO	16	8	EO
20	8	OE	80	20	OE	10	8	OE	10	8	OE	10	8	OE	10	8	OE	10	8	OE	10	8	OE
10	8	OE	50	20	OE	6	8	OE	6	8	OE	6	8	OE	6	8	OE	6	8	OE	6	8	OE
25	8	OE	110	20	OE	14	8	EO	14	8	EO	14	8	EO	14	8	EO	14	8	EO	14	8	EO
20	8	OE	95	20	OE	12	8	EO	12	8	EO	12	8	EO	12	8	EO	12	8	EO	12	8	EO
15	8	OE	65	20	OE	8	8	OE	8	8	OE	8	8	OE	8	8	OE	8	8	OE	8	8	OE
25	8	OE	110	20	OE	14	8	EO	14	8	EO	14	8	EO	14	8	EO	14	8	EO	14	8	EO
20	8	OE	80	20	OE	10	8	EO	10	8	EO	10	8	EO	10	8	EO	10	8	EO	10	8	EO
						8	8		8	8		8	8		8	8		8	8		8	8	
						12	8		12	8		12	8		12	8		12	8		12	8	
						6	8		6	8		6	8		6	8		6	8		6	8	
35	8	OE	120	20	OE	20	8	EO	20	8	EO	20	8	EO	20	8	EO	20	8	EO	20	8	EO
30	8	OE	95	20	OE	16	8	EO	16	8	EO	16	8	EO	16	8	EO	16	8	EO	16	8	EO
45	8	OE	145	20	OE	24	8	EO	24	8	EO	24	8	EO	24	8	EO	24	8	EO	24	8	EO
35	8	OE	120	20	OE	20	8	EO	20	8	EO	20	8	EO	20	8	EO	20	8	EO	20	8	EO
35	8	OE	120	20	OE	20	8	EO	20	8	EO	20	8	EO	20	8	EO	20	8	EO	20	8	EO
30	8	OE	95	20	OE	16	8	EO	16	8	EO	16	8	EO	16	8	EO	16	8	EO	16	8	EO
35	8	OE	110	20	OE	18	8	EO	18	8	EO	18	8	EO	18	8	EO	18	8	EO	18	8	EO
115	8	OE				63	10	EO	63	10	EO	63	10	EO	63	10	EO	63	10	EO	63	10	EO
115	8	OE				63	10	EO	63	10	EO	63	10	EO	63	10	EO	63	10	EO	63	10	EO
90	8	OE				50	10	EO	50	10	EO	50	10	EO	50	10	EO	50	10	EO	50	10	EO
80	8	OE				45	10	EO	45	10	EO	45	10	EO	45	10	EO	45	10	EO	45	10	EO
65	8	OE				36	10	EO	36	10	EO	36	10	EO	36	10	EO	36	10	EO	36	10	EO
80	8	O				45	10	O	45	10	O	45	10	O	45	10	O	45	10	O	45	10	O
80	8	OE				45	10	EO	45	10	EO	45	10	EO	45	10	EO	45	10	EO	45	10	EO
65	8	OE				36	10	EO	36	10	EO	36	10	EO	36	10	EO	36	10	EO	36	10	EO
70	8	OE				40	10	EO	40	10	EO	40	10	EO	40	10	EO	40	10	EO	40	10	EO
20	8	OE				12	10	EO	12	10	EO	12	10	EO	12	10	EO	12	10	EO	12	10	EO
						12	8	EO	12	8	EO	12	8	EO	12	8	EO	12	8	EO	12	8	EO
						10	8	EO	10	8	EO	10	8	EO	10	8	EO	10	8	EO	10	8	EO
						10	8	EO	10	8	EO	10	8	EO	10	8	EO	10	8	EO	10	8	EO
						6	8	EO	6	8	EO	6	8	EO	6	8	EO	6	8	EO	6	8	EO
						6	8	EO	6	8	EO	6	8	EO	6	8	EO	6	8	EO	6	8	EO
						10	8	EO	10	8	EO	10	8	EO	10	8	EO	10	8	EO	10	8	EO
						8	8	EO	8	8	EO	8	8	EO	8	8	EO	8	8	EO	8	8	EO
						6	8	EO	6	8	EO	6	8	EO	6	8	EO	6	8	EO	6	8	EO
						12	8	EO	12	8	EO	12	8	EO	12	8	EO	12	8	EO	12	8	EO
						12	8	EO	12	8	EO	12	8	EO	12	8	EO	12	8	EO	12	8	EO
40	8	E				22	8	E	22	8	E	22	8	E	22	8	E	22	8	E	22	8	E
40	8	E				22	8	L	22	8	L	22	8	L	22	8	L	22	8	L	22	8	L
30	8	E				16	8	L	16	8	L	16	8	L	16	8	L	16	8	L	16	8	L

Cutting data for reamers

= Cutting data for wet machining = Dry machining is possible, cutting data must be selected from Walter GPS E = Emulsion O = Oil M = MQL L = Dry v_C = Cutting speed VRR = Feed rating chart from page B-125				Dimensions			DIN 212							
				Designation			F1342			F1352 F1352HUN				
Structure of main material groups and code letters				Form			A / C			B / D				
				Type			Straight flute			Left-hand spiral				
Workpiece material				Ø range (mm)			1,00 – 20,00			0,90 – 20,00				
				Cutting tool material			HSS-E			HSS-E				
Material group				Coating			uncoated			uncoated				
				Page			<i>B 322*</i>			<i>B 325* / B 329*</i>				
				Brinell hardness HB	Tensile strength R _m N/mm ²	Machining group ¹								
							v _C	VRR				v _C	VRR	
P	Non-alloyed steel	C ≤ 0.25%	annealed	125	428	P1	14	8	EO		14	8	EO	
		C > 0.25... ≤ 0.55%	annealed	190	639	P2	14	8	EO		14	8	EO	
		C > 0.25... ≤ 0.55%	tempered	210	708	P3	13	8	EO		13	8	EO	
		C > 0.55%	annealed	190	639	P4	14	8	EO		14	8	EO	
		C > 0.55%	tempered	300	1013	P5								
		machining steel (short-chipping)	annealed	220	745	P6	14	8	EO		14	8	EO	
	Low-alloyed steel		annealed	175	591	P7	14	8	EO		14	8	EO	
			tempered	300	1013	P8	10	8	EO		10	8	EO	
			tempered	380	1282	P9								
			tempered	430	1477	P10								
	High-alloyed steel and high-alloyed tool steel		annealed	200	675	P11	4	8	EO		4	8	EO	
			hardened and tempered	300	1013	P12								
			hardened and tempered	400	1361	P13								
	Stainless steel		ferritic/martensitic, annealed	200	675	P14	4	8	EO		4	8	EO	
			martensitic, tempered	330	1114	P15								
M	Stainless steel		austenitic, quench hardened	200	675	M1								
			austenitic, precipitation hardened (PH)	300	1013	M2								
			austenitic/ferritic, duplex	230	778	M3								
K	Malleable cast iron		ferritic	200	675	K1	11	8	EO		11	8	EO	
			pearlitic	260	867	K2	8	8	EO		8	8	EO	
	Grey cast iron		low tensile strength	180	602	K3	13	8	EO		13	8	EO	
			high tensile strength/austenitic	245	825	K4	11	8	EO		11	8	EO	
	Cast iron with spheroidal graphite		ferritic	155	518	K5	11	8	EO		11	8	EO	
			pearlitic	265	885	K6	8	8	EO		8	8	EO	
	GGV (CGI)		200	675	K7	10	8	EO		10	8	EO		
N	Aluminium wrought alloys		cannot be hardened	30	–	N1	28	10	EO		28	10	EO	
			hardenable, hardened	100	343	N2	28	10	EO		28	10	EO	
	Cast aluminium alloys		≤ 12% Si, cannot be hardened	75	260	N3	18	10	EO		18	10	EO	
			≤ 12% Si, hardenable, hardened	90	314	N4	13	10	EO		13	10	EO	
			> 12% Si, cannot be hardened	130	447	N5								
	Magnesium alloys			70	250	N6	13	10	O		13	10	O	
		Copper and copper alloys (bronze/brass)		non-alloyed, electrolytic copper	100	343	N7	21	10	EO		21	10	EO
	brass, bronze, red brass		90	314	N8	17	10	EO		17	10	EO		
	Cu-alloys, short-chipping		110	382	N9	30	10	EO		30	10	EO		
	high-strength, Ampco		300	1013	N10									
S	Heat-resistant alloys	Fe-based	annealed	200	675	S1								
			hardened	280	943	S2								
		Ni or Co base	annealed	250	839	S3								
			hardened	350	1177	S4								
			cast	320	1076	S5								
	Titanium alloys		pure titanium	200	675	S6								
			α and β alloys, hardened	375	1262	S7								
		β alloys	410	1396	S8									
	Tungsten alloys		300	1013	S9									
	Molybdenum alloys		300	1013	S10									
H	Hardened steel		hardened and tempered	50 HRC	–	H1								
			hardened and tempered	55 HRC	–	H2								
			hardened and tempered	60 HRC	–	H3								
		Hardened cast iron		hardened and tempered	55 HRC	–	H4							
O	Thermoplasts		without abrasive fillers			O1	18	8	E		18	8	E	
	Thermosetting plastics		without abrasive fillers			O2	11	8	L		11	8	L	
	Plastic, glass fibre reinforced		GFRP			O3								
	Plastic, carbon fibre reinforced		CFRP			O4								
	Plastic, aramid fibre reinforced		AFRP			O5								
	Graphite (technical)			80 Shore			O6							

¹ The classification of the machining groups can be found in the Walter General catalogue 2012 from page H 8 onwards.

* The pages indicated in italics refer to the Walter General catalogue 2012.

The specified cutting data are average recommended values.
For special applications, adjustment is recommended.

				DIN 208			DIN 219			DIN 2179			DIN 2180			DIN 311						
				F4142			F4152			F7133			F3234			F6134			F4535			
				A			B			B			-			-			-			
				Straight flute			Left-hand spiral			Left-hand spiral			Taper 1:50			Taper 1:50			Bridge reamers			
				5,00 – 32,00			5,00 – 40,00			25,00 – 60,00			1,00 – 12,00			5,00 – 20,00			6,40 – 32,00			
				HSS-E			HSS-E			HSS			HSS-E			HSS-E			HSS			
				uncoated			uncoated			uncoated			uncoated			uncoated			uncoated			
				B 337*			B 338*			B 345* / G 66*			B 334*			B 344*			B 343*			
				v _c VRR			v _c VRR			v _c VRR			v _c VRR			v _c VRR			v _c VRR			
14	8	EO		14	8	EO		14	8	EO		8	8	EO		8	8	EO		8	8	EO
14	8	EO		14	8	EO		14	8	EO		8	8	EO		8	8	EO		8	8	EO
13	8	EO		13	8	EO		13	8	EO		8	8	EO		8	8	EO		8	8	EO
14	8	EO		14	8	EO		14	8	EO		8	8	EO		8	8	EO		8	8	EO
14	8	EO		14	8	EO		14	8	EO		8	8	EO		8	8	EO		8	8	EO
14	8	EO		14	8	EO		14	8	EO		8	8	EO		8	8	EO		8	8	EO
14	8	EO		14	8	EO		14	8	EO		8	8	EO		8	8	EO		8	8	EO
10	8	EO		10	8	EO		10	8	EO		5	8	EO		5	8	EO		5	8	EO
4	8	EO		4	8	EO		4	8	EO		2	8	EO		2	8	EO		2	8	EO
4	8	EO		4	8	EO		4	8	EO		2	8	EO		2	8	EO		2	8	EO
11	8	EO		11	8	EO		11	8	EO		6	8	EO		6	8	EO		6	8	EO
8	8	EO		8	8	EO		8	8	EO		5	8	EO		5	8	EO		5	8	EO
13	8	EO		13	8	EO		13	8	EO		8	8	EO		8	8	EO		8	8	EO
11	8	EO		11	8	EO		11	8	EO		6	8	EO		6	8	EO		6	8	EO
11	8	EO		11	8	EO		11	8	EO		6	8	EO		6	8	EO		6	8	EO
8	8	EO		8	8	EO		8	8	EO		5	8	EO		5	8	EO		5	8	EO
10	8	EO		10	8	EO		10	8	EO		5	8	EO		5	8	EO		5	8	EO
28	10	EO		28	10	EO		28	10	EO		16	10	EO		16	10	EO		16	10	EO
28	10	EO		28	10	EO		28	10	EO		16	10	EO		16	10	EO		16	10	EO
18	10	EO		18	10	EO		18	10	EO		11	10	EO		11	10	EO		11	10	EO
13	10	EO		13	10	EO		13	10	EO		8	10	EO		8	10	EO		8	10	EO
13	10	O		13	10	O		13	10	O		8	10	O		8	10	O		8	10	O
21	10	EO		21	10	EO		21	10	EO		12	10	EO		12	10	EO		12	10	EO
17	10	EO		17	10	EO		17	10	EO		10	10	EO		10	10	EO		10	10	EO
30	10	EO		30	10	EO		30	10	EO		17	10	EO		17	10	EO		17	10	EO
18	8	E		18	8	E		18	8	E		10	8	E		10	8	E		10	8	E
11	8	L		11	8	L		11	8	L		6	8	L		6	8	L		6	8	L

VCRR: RPM diagram Solid carbide micro-drill

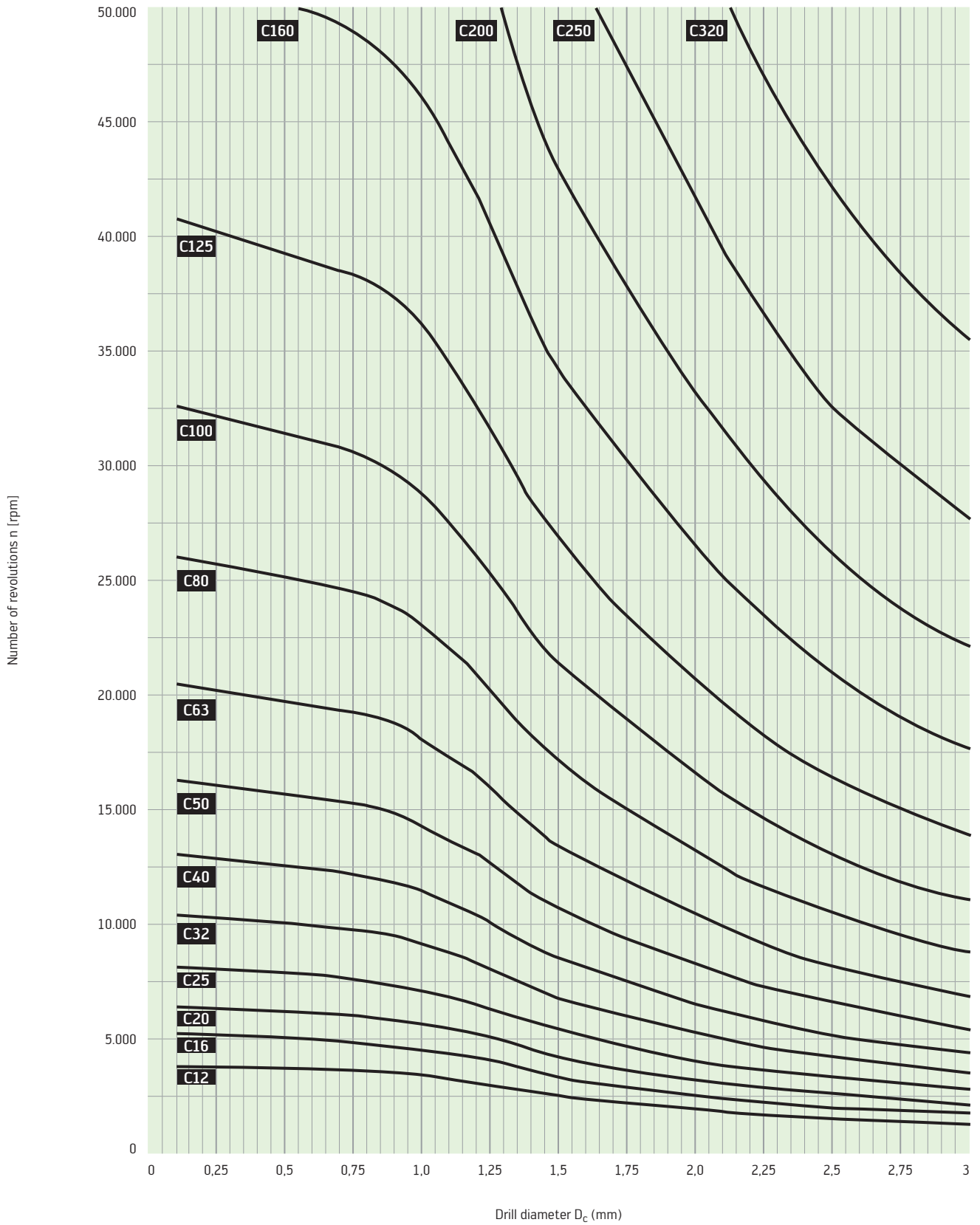

VCRR: RPM diagram HSS micro-drill

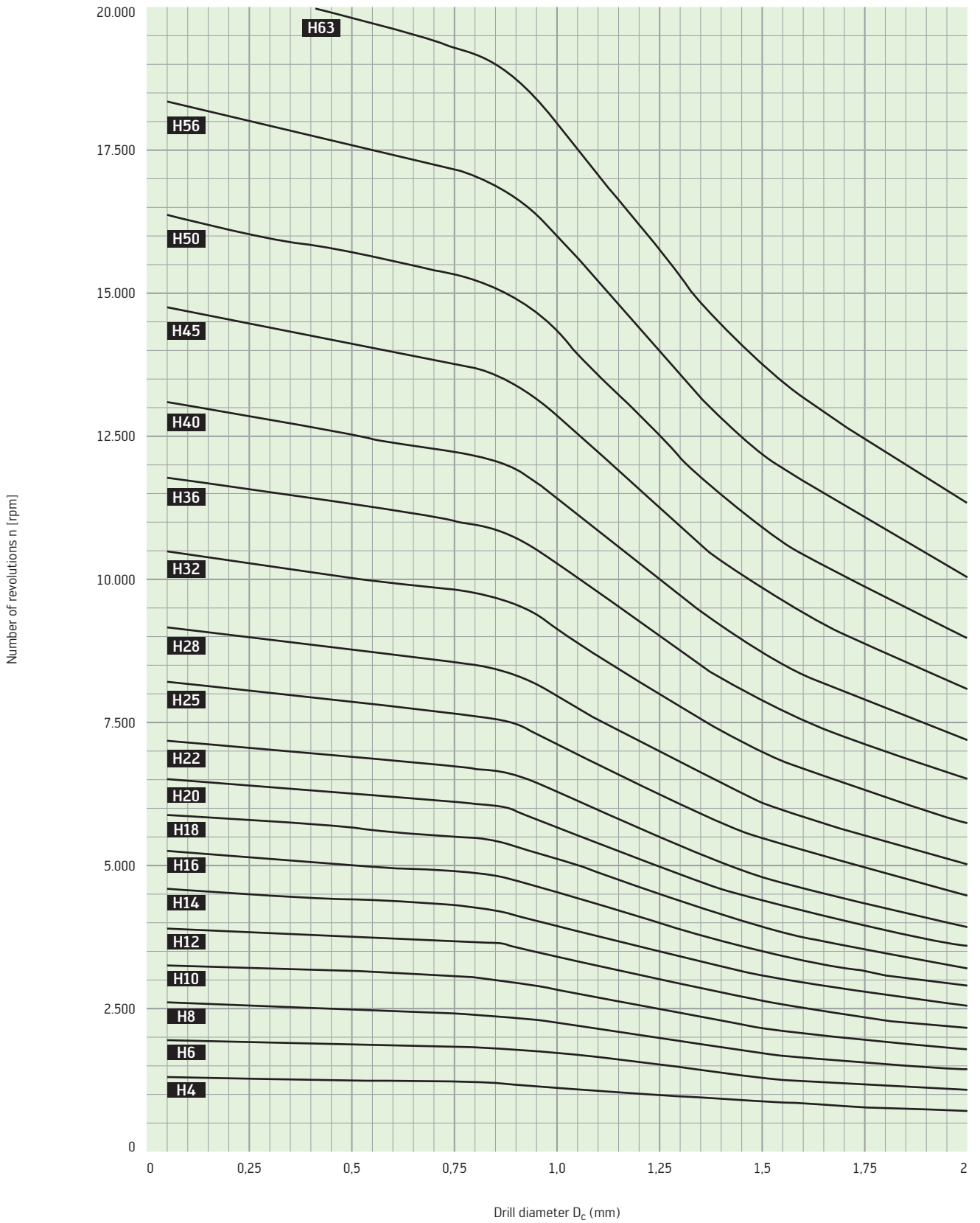

VRR: feed rate charts for HSS and carbide drills, core drills, countersinks and centre drills

VRR	Feed f (mm) for Ø (mm)														
	0,05	0,06	0,08	0,1	0,12	0,15	0,2	0,25	0,4	0,5	0,6	0,8	1	1,2	1,5
1	0,001	0,001	0,001	0,001	0,001	0,001	0,001	0,001	0,001	0,002	0,002	0,003	0,003	0,004	0,005
2	0,001	0,001	0,001	0,001	0,001	0,001	0,001	0,002	0,003	0,003	0,004	0,005	0,007	0,008	0,010
3	0,001	0,001	0,001	0,001	0,001	0,002	0,002	0,003	0,004	0,005	0,006	0,008	0,010	0,012	0,015
4	0,001	0,001	0,001	0,001	0,002	0,002	0,003	0,003	0,005	0,007	0,008	0,011	0,013	0,016	0,020
5	0,001	0,001	0,001	0,002	0,002	0,003	0,003	0,004	0,007	0,008	0,010	0,013	0,017	0,020	0,025
6	0,001	0,001	0,002	0,002	0,002	0,003	0,004	0,005	0,008	0,010	0,012	0,016	0,020	0,024	0,030
7	0,001	0,001	0,002	0,002	0,003	0,004	0,005	0,006	0,009	0,012	0,014	0,019	0,023	0,028	0,035
8	0,001	0,002	0,002	0,003	0,003	0,004	0,005	0,007	0,011	0,013	0,016	0,021	0,027	0,032	0,040
9	0,002	0,002	0,002	0,003	0,004	0,005	0,006	0,008	0,012	0,015	0,018	0,024	0,030	0,036	0,045
10	0,002	0,002	0,003	0,003	0,004	0,005	0,007	0,008	0,013	0,017	0,020	0,027	0,033	0,040	0,050
12	0,002	0,002	0,003	0,004	0,005	0,006	0,008	0,010	0,016	0,020	0,024	0,032	0,040	0,048	0,060
16	0,003	0,003	0,004	0,005	0,006	0,008	0,011	0,013	0,021	0,027	0,032	0,043	0,053	0,064	0,080
20	0,003	0,004	0,005	0,007	0,008	0,010	0,013	0,017	0,027	0,033	0,040	0,053	0,067	0,080	0,10

VRR	Feed f (mm) for Ø (mm)															
	2	2,5	4	5	6	8	10	12	15	20	25	40	50	60	80	100
1	0,007	0,008	0,013	0,017	0,018	0,021	0,024	0,026	0,029	0,033	0,037	0,047	0,053	0,058	0,067	0,075
2	0,013	0,017	0,027	0,033	0,037	0,042	0,047	0,052	0,058	0,067	0,075	0,094	0,11	0,12	0,13	0,15
3	0,020	0,025	0,040	0,050	0,055	0,063	0,071	0,077	0,087	0,10	0,11	0,14	0,16	0,17	0,20	0,22
4	0,027	0,033	0,053	0,067	0,073	0,084	0,094	0,10	0,12	0,13	0,15	0,19	0,21	0,23	0,27	0,30
5	0,033	0,042	0,067	0,083	0,091	0,11	0,12	0,13	0,14	0,17	0,19	0,24	0,26	0,29	0,33	0,37
6	0,040	0,050	0,080	0,10	0,11	0,13	0,14	0,15	0,17	0,20	0,22	0,28	0,32	0,35	0,40	0,45
7	0,047	0,058	0,093	0,12	0,13	0,15	0,16	0,18	0,20	0,23	0,26	0,33	0,37	0,40	0,47	0,52
8	0,053	0,067	0,11	0,13	0,15	0,17	0,19	0,21	0,23	0,27	0,30	0,38	0,42	0,46	0,53	0,60
9	0,060	0,075	0,12	0,15	0,16	0,19	0,21	0,23	0,26	0,30	0,34	0,42	0,47	0,52	0,60	0,67
10	0,067	0,083	0,13	0,17	0,18	0,21	0,24	0,26	0,29	0,33	0,37	0,47	0,53	0,58	0,67	0,75
12	0,080	0,10	0,16	0,20	0,22	0,25	0,28	0,31	0,35	0,40	0,45	0,57	0,63	0,69	0,80	0,89
16	0,11	0,13	0,21	0,27	0,29	0,34	0,38	0,41	0,46	0,53	0,60	0,75	0,84	0,92	1,07	1,19
20	0,13	0,17	0,27	0,33	0,37	0,42	0,47	0,52	0,58	0,67	0,75	0,94	1,05	1,15	1,33	1,49

VRR: Feed rate charts for reamers

VRR	Feed f (mm) for Ø (mm)															
	1	1,2	1,5	2	2,5	4	5	6	8	10	12	15	20	25	40	50
6	0,04	0,04	0,04	0,05	0,06	0,08	0,09	0,10	0,12	0,14	0,15	0,17	0,21	0,23	0,31	0,35
8	0,05	0,05	0,06	0,07	0,08	0,11	0,12	0,14	0,16	0,18	0,20	0,23	0,27	0,31	0,41	0,47
10	0,06	0,07	0,07	0,09	0,10	0,13	0,15	0,17	0,20	0,23	0,25	0,29	0,34	0,39	0,51	0,59
12	0,07	0,08	0,09	0,11	0,12	0,16	0,18	0,20	0,24	0,27	0,30	0,35	0,41	0,47	0,62	0,70
20						0,18	0,30	0,70	0,80	0,90	1,00	1,20	1,30			

Hole material removal for reaming tools

Material removal in Ø (mm)			
≤5	5-12	12-16	16-20
0,1	0,1-0,2	0,2	0,2-0,3

Cutting tool materials

HSS cutting tool materials

4 groups of high-speed steel are used for Walter Titex tools:

HSS	High-speed steel for general applications (twist drills, core drills, countersinks, reamers in some cases, centre drills, multi-diameter step drills)
HSS-E	High-speed steel with 5% Co for increased loading, particularly extreme thermal loading (high-performance twist drill, reamers in some cases)
HSS-E Co8	High-speed steel with 8% Co for maximum thermal loading capability, in accordance with American standard designation M 42 (Special tools)
HSS-PM	High-speed steel manufactured using powder metallurgy with extremely high alloy content Advantages: High degree of purity and uniformity, outstanding wear resistance and thermal loading capability (Special tools)

	Material no.	Short name	Old standard Designation	AISI ASTM	AFNOR	B.S.	UNI	Alloy table					
								C	Cr	W	Mo	V	Co
HSS	1.3343	S 6-5-2	DMo5	M2	–	BM2	HS 6-5-2	0,82	4,0	6,5	5,0	2,0	–
HSS-E	1.3243	S 6-5-2-5	EMo5 Co5	M35	6.5.2.5	–	HS 6-5-2-5	0,82	4,5	6,0	5,0	2,0	5,0
HSS-E Co8	1.3247	S 2-10-1-8	–	M42	–	BM42	HS 2-9-1-8	1,08	4,0	1,5	9,5	1,2	8,25
HSS-PM	Trade designation ASP												

Carbide cutting tool materials

Carbides mainly consist of tungsten carbide (WC) as the hard material and cobalt (Co) as the binding material.

In the majority of cases, the cobalt content is between 6 and 12%. The following rule generally applies:

The higher the cobalt content, the tougher the material, but the less resistance to wear and vice-versa.

Another determining factor in carbides is the grain size. The hardness increases as the grain size becomes finer.

		Co in %	Grain size	Hardness HV
K10	– extremely wear-resistant substrate – use in brazed drilling and boring tools	6	normal	1650
K20F	– extremely wear-resistant substrate with fine grain size – use in short-chipping materials such as cast iron workpieces	6–7	fine	1650–1800
K30F	– extremely fine substrate, extremely tough and wear-resistant – universal application for a variety of materials	10	finest	1550

Surface treatments and hard material coating for increasing performance

Surface treatments

Steam treatment of tools made from HSS

Implementation	Dry steam atmosphere, 520 °C to 580 °C
Effect	Adherent oxide layer consisting of Fe ₃ O ₄ approx. 0.003 to 0.010 mm deep
Property	<ul style="list-style-type: none"> – low inclination towards cold welding – increased surface hardness and therefore improved wear resistance – increased corrosion resistance – improved sliding properties due to better lubricant adhesion as a result of FeO crystals – reduction in grinding stress

Nitriding of tools made from HSS

Implementation	Treatment in media giving off nitrogen, 520 °C to 570 °C
Effect	Enrichment of surface with nitrogen and partially with carbon
Property	<ul style="list-style-type: none"> – low inclination towards cold welding and built up edges – increased hardness and therefore more wear resistance

















Hard material coatings

Surface coating has developed into a proven technological process for improving the performance of metal cutting tools. By contrast with surface treatment, the tool surface remains chemically unaltered and a thin layer is applied. With Walter Titex tools made from high-speed steel and carbide, PVD processes are used for coating which operate at process temperatures of less than 600 °C and therefore do not change the basic tool material. Hard material layers have a higher hardness and wear resistance than the cutting tool material itself.













Also:

- they separate the cutting tool material and the material that is going to be cut from each other
- they act as a thermal insulating layer

Coated tools not only have a longer life, they can also be used with higher cutting speeds and feed rates.

Surface treatment/ coating	Process/ coating	Property	Example tool
Uncoated	No treatment	–	
Steam treated	Steam treatment	Universal treatment for HSS	
Fibre-steamed	Steam treatment	Universal treatment of lands for HSS	
TiN	TiN coating	Universal coating	
TiP	TiN point coating	Special coating for optimum chip evacuation	
TfL	Tinal coating	High-performance coating with a wide range of applications	
TfT	Tinal TOP coating	High-performance coating with particularly low friction	
TfP	Tinal point coating	High-performance coating for optimum chip evacuation	
TfTP	Tinal point coating	High-performance coating with particularly low friction	
TmL	Tinal micro- coating	Special coating for small drills with extremely low friction	
XPL	AlCrN coating	High-performance coating for maximum wear resistance	
DPL	Double coating	High-performance coating for maximum wear resistance	
DPP	Double point coating	High-performance coating for maximum wear resistance and optimum chip evacuation	
AML	AlTiN micro coating	Special coating for small drills with extremely low friction	
AMP	AlTiN micro point coating	Special coating for small drills with extremely low friction and optimum chip evacuation	
TMS	AlTiN thin coating	High performance coating for solid carbide reaming tools	













Tool types

Tool type	Remarks on field of applications	Workpiece material group						
		P	M	K	N	S	H	O
		Steel	Stainless steel	Cast iron	NF metals	Difficult-to-machine materials	Hard materials	Other
X-treme Pilot 150 	– Pilot drill, specially designed for X-treme DM... – 150° point angle	●●	●●	●●	●●	●●	●●	●●
X-treme M, DM8 ... DM30 	– Solid carbide micro deep-hole drill diameter 2.00–2.95 mm, 5 to 30 x D _C with internal cooling – D stands for "Deep" – M stands for "Micro" – For universal use	●●	●●	●●	●●	●●	●	●●
Alpha® 4 Plus Micro 	– Solid carbide micro-drill diameter 0.75-1.95 mm, 8 and 12 x D _C with internal cooling – For universal use	●●	●●	●●	●●	●●	●	●●
Alpha® 2 Plus Micro 	– Solid carbide micro-drill diameter 0.5-3 mm, 5 and 8 x D _C without internal cooling – For universal use	●●		●●	●●	●●	●	●●
X-treme Step 90 	– Solid carbide chamfer drill with internal cooling – Step length in accordance with DIN 8378 – Can be used universally with high cutting data	●●	●●	●●	●●	●●	●●	
X-treme Step 90 	– Solid carbide chamfer drill without internal cooling – Step length in accordance with DIN 8378 – Can be used universally with high cutting data	●●	●●	●●	●●	●●	●●	●●
X-treme 	– Solid carbide drill in acc. with DIN 6537 short/long with internal cooling – Can be used universally with high cutting data	●●	●●	●●	●●	●●	●●	
X-treme 	– Solid carbide drill in acc. with DIN 6537 short/long without internal cooling – Can be used universally with high cutting data	●●	●●	●●	●●	●●	●●	●●
X-treme Plus 	– Solid high-performance carbide drill in acc. with DIN 6537 long with internal cooling – Can be used universally with maximum cutting data	●●	●●	●●	●●	●●	●●	●
X-treme CI 	– Solid carbide high-performance drill in acc. with DIN 6537 long with internal cooling – Specially developed for cast iron materials – CI stands for "Cast iron"			●●				
X-treme Inox 	– Solid carbide drill in acc. with DIN 6537 short/long with internal cooling – Specially developed for stainless steels	●●	●●		●	●●		●
Alpha® Ni 	– Solid carbide drill in acc. with DIN 6537 long with internal cooling – Specially developed for Ni alloys	●	●			●●	●	

Drilling depth

	2 x D _c	3 x D _c	5 x D _c	8 x D _c	12 x D _c	16 x D _c	20 x D _c	25 x D _c	30 x D _c
A6181AML									
			A3389AML	A6489AMP	A6589AMP	A6689AMP	A6789AMP	A6889AMP	A6989AMP
				A6488TML	A6588TML				
			A3378TML	A6478TML					
		K3299XPL K3899XPL							
		K3879XPL							
		A3299XPL A3899XPL	A3399XPL A3999XPL						
		A3279XPL A3879XPL	A3379XPL A3979XPL						
		A3289DPL	A3389DPL						
			A3382XPL						
		A3293TTP	A3393TTP						
			A3384						

Tool types

Tool type	Remarks on field of applications	Workpiece material group						
		P	M	K	N	S	H	O
		Steel	Stainless steel	Cast iron	NF metals	Difficult-to-machine materials	Hard materials	Other
Alpha® Rc 	<ul style="list-style-type: none"> – Solid carbide drill in acc. with DIN 6537 short without internal cooling – Specially developed for hardened materials 				••	••	••	
Alpha® Jet 	<ul style="list-style-type: none"> – Straight flute solid carbide drill in acc. with DIN 6537 long, 8 and 12 x D_C with internal cooling – For short-chipping cast iron and aluminium materials 			••	••	•		••
X-treme D8...D12 	<ul style="list-style-type: none"> – Solid carbide deep-hole drill, 8 x D_C and 12 x D_C with internal cooling – D stands for "Deep" – Can be used universally with high cutting data 	••	••	••	••	••	••	•
Alpha® 44 	<ul style="list-style-type: none"> – Solid carbide drill 8 x D_C with internal cooling – UFL® profile – For universal use 	••	•	•	••	••		••
Alpha® 22 	<ul style="list-style-type: none"> – Solid carbide drill 8 x D_C without internal cooling – UFL® profile – For universal use 	••		••	••	••		
X-treme Pilot Step 90 	<ul style="list-style-type: none"> – Stepped pilot drill, specially designed for Alpha® 4 XD, X-treme D & DH and XD70 technology with internal cooling – 150° point angle – 90° countersink angle 	••	••	••	••	••	••	••
XD Pilot 	<ul style="list-style-type: none"> – Pilot drill, specially designed for Alpha® 4 XD, X-treme D & DH and XD70 technology with internal cooling – 150° point angle 	••	••	••	••	••	••	••
X-treme Pilot 180 	<ul style="list-style-type: none"> – Pilot drill, specially designed for Alpha® 4 XD, X-treme D & DH and XD70 technology with internal cooling – 180° point angle – Specially developed for angled and convex surfaces 	••	••	••	••	••	••	••
X-treme Pilot 180C 	<ul style="list-style-type: none"> – Pilot drill, specially designed for Alpha® 4 XD, X-treme D & DH and XD70 technology with internal cooling – Specially developed for angled and convex surfaces – The conical design means that there is no shoulder between the pilot hole and the deep-hole drill (important with crankshafts) – 180° point angle 	••	••	••	••	••	••	••
Alpha® 4 XD16...30 	<ul style="list-style-type: none"> – Solid carbide deep-hole drill 16 to 30 x D_C with internal cooling – For universal use 	••	••	••	••	••	•	••
X-treme DH20 - DH30 	<ul style="list-style-type: none"> – Solid carbide deep-hole drill, 20 x D_C and 30 x D_C with internal cooling – D stands for "Deep" – H stands for "Heavy duty materials" (steel that is difficult to cut), e.g. crankshafts 	••	••	••	•	••	•	
X-treme D40 	<ul style="list-style-type: none"> – Solid carbide deep-hole drill 40 x D_C with internal cooling – For universal use 	••	•	••	••	•		

Drilling depth









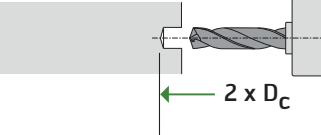

	2 x D _c	3 x D _c	5 x D _c	8 x D _c	12 x D _c	16 x D _c	20 x D _c	25 x D _c	30 x D _c	40 x D _c
		A3269TFL								
			A3387	A3487	A3687					
				A6489DPP	A6589DPP					
				A3486TIP A3586TIP						
				A1276TFL						
	K3281TFT									
	A6181TFT									
	A7191TFT									
	K5191TFT									
						A6685TFP	A6785TFP	A6885TFP	A6985TFP	
							A6794TFP		A6994TFP	
										A7495TTP

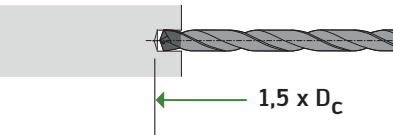
Drilling strategy 1: XD technology $\leq 30 \times D_c$

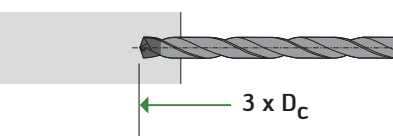
suitable for:

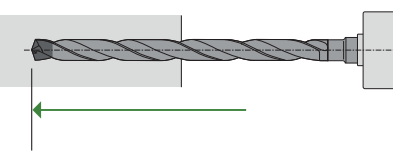
- A6685TFP	- A6985TFP
- A6785TFP	- A6794TFP
- A6885TFP	- A6994TFP

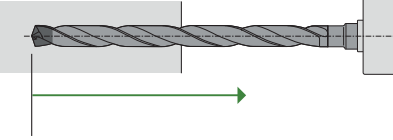
P	M	K	N	S	H	O
✓	✓	✓		✓	✓	✓

<p>1 Pilot drilling 1</p>  <p>2 x D_c</p>	 <p>10 - 30 bar on</p>	<p>2 x D_c A6181TFT A7191TFT K5191TFT K3281TFT</p>
<p>2 Piloting</p>  <p>1,5 x D_c</p>	 <p>off</p>	<p>XD Technology</p> <p>$n_{max} = 100 \text{ rpm}$ $v_f = 1000 \text{ mm/min}$</p>
<p>3 Spot drilling</p>  <p>3 x D_c</p>	 <p>10 - 30 bar on</p>	<p>XD Technology</p> <p>$v_c = 25 - 50 \%$ $v_f = 25 - 50 \%$</p>
<p>4 Deep-hole drilling</p> 	 <p>10 - 30 bar on</p>	<p>XD Technology</p> <p>$v_c = 100\%$ $v_f = 100\%$</p>
<p>5 Retract</p> 	 <p>off</p>	<p>XD Technology</p> <p>$n_{max} = 100 \text{ rpm}$ $v_f = 1000 \text{ mm/min}$</p>







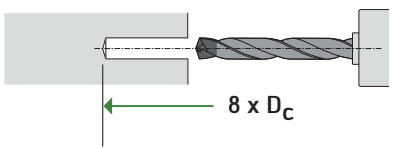

 $V_c / V_f \rightarrow$  GPS

Drilling strategy 2: XD technology $\leq 30 \times D_c$

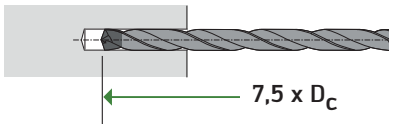
suitable for:

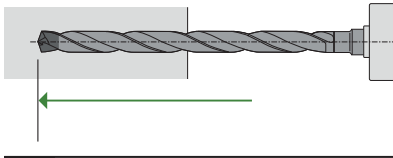
- A6685TFP	- A6885TFP
- A6785TFP	- A6985TFP

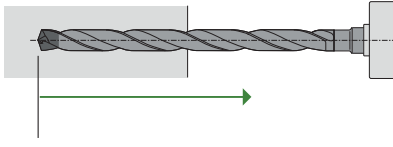
P	M	K	N	S	H	O
			✓			

<p>1 Pilot drilling</p> 	 <p>10 - 30 bar on</p>	<p>8 x D_C A6489DPP</p>
<p>2 Piloting</p> 	 <p>off</p>	<p>XD Technology</p> <p>$n_{max} = 100 \text{ rpm}$ $v_f = 1000 \text{ mm/min}$</p>
<p>3 Deep-hole drilling</p> 	 <p>10 - 30 bar on</p>	<p>XD Technology</p> <p>$v_c = 100\%$ $v_f = 100\%$</p>
<p>4 Retract</p> 	 <p>off</p>	<p>XD Technology</p> <p>$n_{max} = 100 \text{ rpm}$ $v_f = 1000 \text{ mm/min}$</p>

$V_c / V_f \rightarrow$ GPS











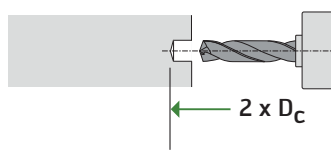

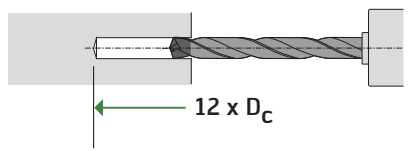
Drilling strategy 3: XD technology $\leq 50 \times D_C$

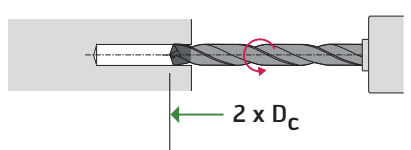
suitable for:

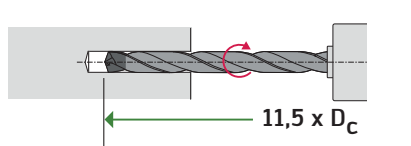
– A7495TTP

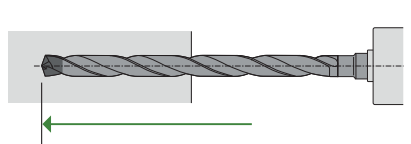
 – Special boring tools up to $50 \times D_C$

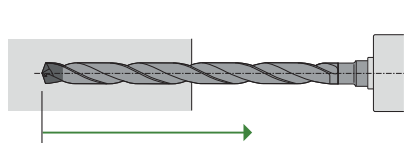
P	M	K	N	S	H	O
✓		✓	✓			











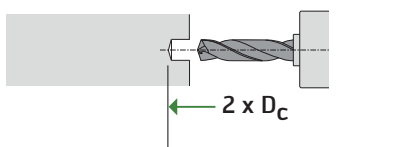

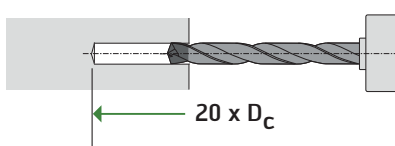
<p>1 Pilot drilling 1</p> 		<p>10 - 30 bar on</p>	<p>$2 \times D_C$ A6181TFT A7191TFT K3281TFT</p>
<p>2 Pilot drilling 2</p> 		<p>10 - 30 bar on</p>	<p>$12 \times D_C$ A6589DPP</p>
<p>3 Piloting</p> 		<p>off</p>	<p>XD Technology</p> <p>With anti-clockwise rotation: $n_{max} = 100 \text{ rpm}$ $v_f = 1000 \text{ mm/min}$</p>
<p>4 Piloting</p> 		<p>off</p>	<p>XD Technology</p> <p>Continue operation with clockwise rotation $n_{max} = 100 \text{ rpm}$ $v_f = 1000 \text{ mm/min}$</p>
<p>5 Deep-hole drilling</p> 		<p>20 - 40 bar on</p>	<p>XD Technology</p> <p>$v_C = 100\%$ $v_f = 100\%$</p>
<p>6 Retract</p> 		<p>off</p>	<p>XD Technology</p> <p>$n_{max} = 100 \text{ rpm}$ $v_f = 1000 \text{ mm/min}$</p>

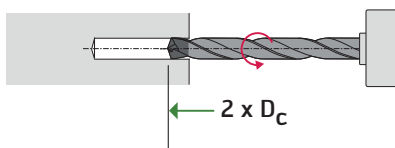
Drilling strategy 4: XD technology $\leq 50 - 70 \times D_c$

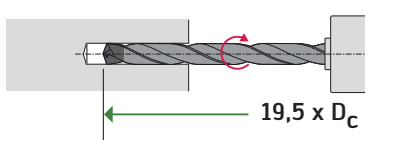
suitable for:

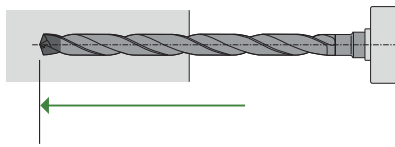
– Special boring tools $\geq 50 \times D_c$

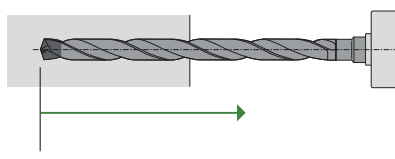
P	M	K	N	S	H	O
✓		✓	✓			







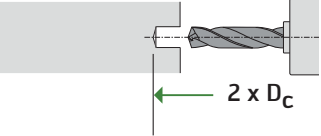

<p>1 Pilot drilling 1</p> 	 <p>10 - 30 bar on</p>	<p>2 x D_c A6181TFT A7191TFT K3281TFT</p>
<p>2 Pilot drilling 2</p> 	 <p>10 - 30 bar on</p>	<p>20 x D_c A6785TFP</p>
<p>3 Piloting</p> 	 <p>off</p>	<p>XD Technology</p> <p>With anti-clockwise rotation: $n_{max} = 100 \text{ rpm}$ $v_f = 1000 \text{ mm/min}$</p>
<p>4 Piloting</p> 	 <p>off</p>	<p>XD Technology</p> <p>Continue operation with clockwise rotation $n_{max} = 100 \text{ rpm}$ $v_f = 1000 \text{ mm/min}$</p>
<p>5 Deep-hole drilling</p> 	 <p>20 - 40 bar on</p>	<p>XD Technology</p> <p>$v_c = 100\%$ $v_f = 100\%$</p>
<p>6 Retract</p> 	 <p>off</p>	<p>XD Technology</p> <p>$n_{max} = 100 \text{ rpm}$ $v_f = 1000 \text{ mm/min}$</p>

Drilling strategy 5: Micro XD technology $\leq 30 \times D_c$

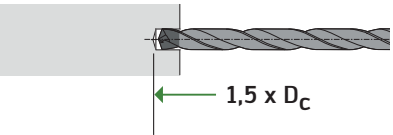
suitable for:

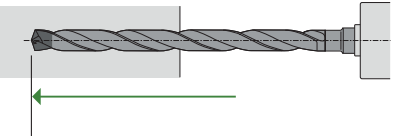
- A6489AMP	- A6789AMP
- A6589AMP	- A6889AMP
- A6689AMP	- A6989AMP

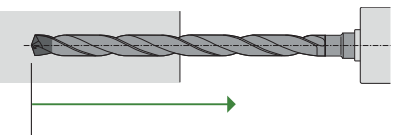
P	M	K	N	S	H	O
✓	✓	✓	✓	✓	✓	✓

<p>1 Pilot drilling</p> 		<p>10 - 30 bar on</p>	<p>2 x D_c A6181AML</p>
<p>2 Piloting</p> 		<p>off</p>	<p>XD Technology</p> <p>$n_{max} = 100 \text{ rpm}$ $v_f = 1000 \text{ mm/min}$</p>
<p>3 Deep-hole drilling</p> 		<p>10 - 30 bar on</p>	<p>XD Technology</p> <p>$v_c = 100\%$ $v_f = 100\%$</p>
<p>4 Retract</p> 		<p>off</p>	<p>XD Technology</p> <p>$n_{max} = 100 \text{ rpm}$ $v_f = 1000 \text{ mm/min}$</p>

 $V_c / V_f \rightarrow$ GPS



Regrinding and coating service: Top quality, easy handling and prompt delivery

The Walter Multiply “Almost as good as new” workflow

Demanding customers require 100% performance at all times. This requirement must of course also apply to reconditioning when it comes to users of high-performance tools. Reconditioned as originally manufactured, a tool is returned to an “almost as good as new” condition by Walter Multiply. This has been proven in actual practice. The recycled tool impresses customers with its 100% performance. It’s worth it, no question about it: The service life of a tool is extended each time it is reconditioned.

Walter Multiply reconditioning is available for:

- Solid carbide drills
- XD drills
- Solid carbide milling cutters*
- Solid carbide and HSS step drills and special tools
- High-performance HSS-Co drills and milling cutters

Regrinding & re-coating pays off

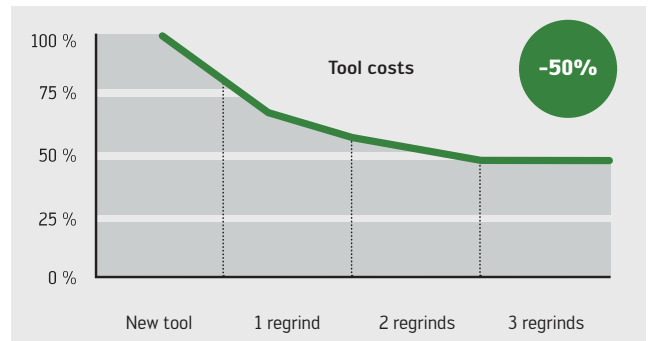

Take advantage of the clear benefits of Walter Multiply:

- Original geometry and coating
- Certified reconditioning cycles
- Stable production processes thanks to consistent tool life



ORIGINAL



Reliable, just like the tool itself: The reconditioning cycle of Walter Multiply

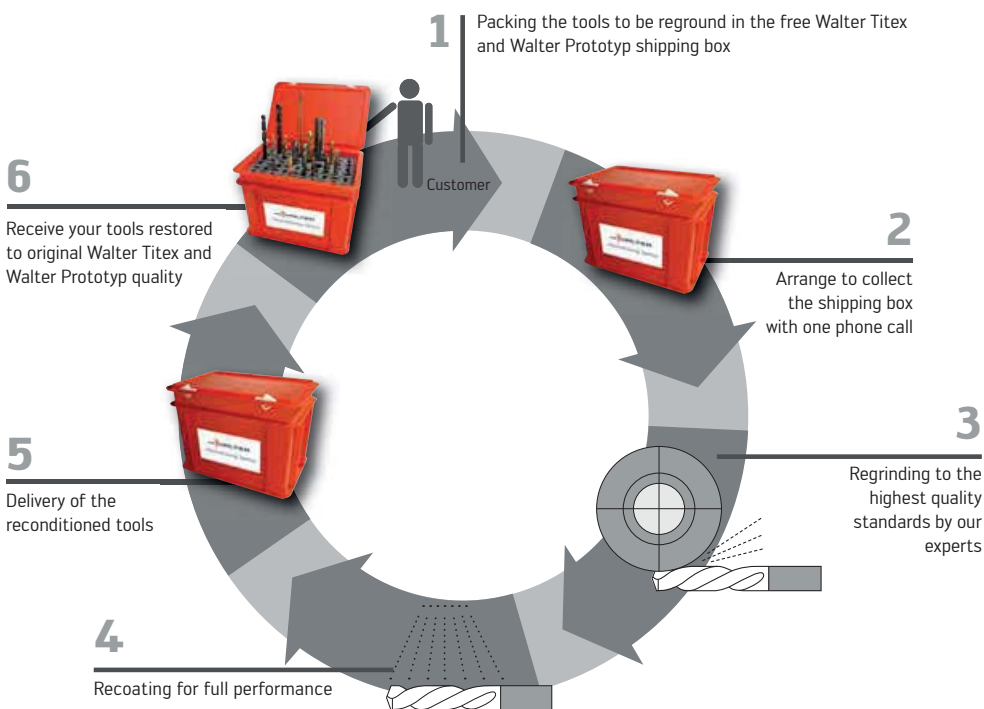

Not to be ignored, and extremely practical: The RedBox for collecting tools is made available and collected by Walter free of charge

* Reconditioning of Walter Prototyp products is not available in all regions. For further details, please contact your local Walter representative.



CONTENTS









Drilling and boring tools with indexable inserts

	Page	
Drilling and boring indexable inserts	Product range overview	C-3
	Designation key	C-4
	Walter Select – Drilling	C-6
	Walter indexable inserts for drilling	C-8
	Walter Select – Counterboring	C-16
	Walter indexable inserts for counterboring	C-19
	Walter Select – Precision boring	C-22
	Walter indexable inserts for precision boring	C-25
Walter drilling and boring tools with indexable inserts	Product range overview	C-30
	Designation key	C-4
	Walter Select – Drilling	C-34
	Walter drills	C-38
	Walter Select – Counterboring, precision boring and reaming	C-42
	Walter two flute boring tools	C-44
	Walter precision drills	C-52
Technical information	Cutting data	C-76
	Cutting tool material application tables	C-90
	Geometry overview of indexing inserts	C-93
	Usage information	C-96
	Information on high-speed cutting	C-97



Product range overview of indexable/ exchangeable inserts for drilling, boring and reaming



Application	Insert shape	Description	Page	
Drilling		P 6001 . . P 6002 . . P 6003 . . P 6004 . .	for drilling	C-8
		L	for drilling	C-14
		P 484 . .	for drilling	C-12
		T	for drilling	C-11
		W	for drilling	C-15
Application	Insert shape	Description	Page	
Counterboring Precision boring		C	for counterboring for precision boring	C-19 C-25
		S	for counterboring	C-20
		W	for counterboring for precision boring	C-21 C-27
Application	Insert shape	Description	Page	
Reaming		P 6500	for reaming	C 35*

* The pages indicated in italics refer to the Walter General catalogue 2012.

Designation key for indexable inserts for drilling

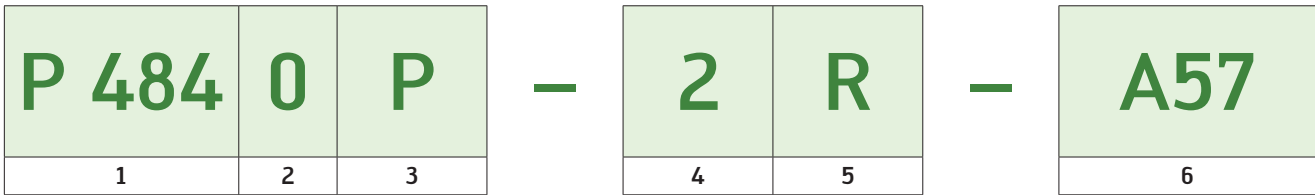

1
Walter indexable insert designation

2
Version
0 Ground 1 Sintered

3
Position
C Centre insert P Outer insert

4
Insert size

5
Cutting direction
R right handed

6
Walter geometry
A57 The stable one E57 The universal one E67 The sharp one

Designation key for Xtra-tec® Insert Drill

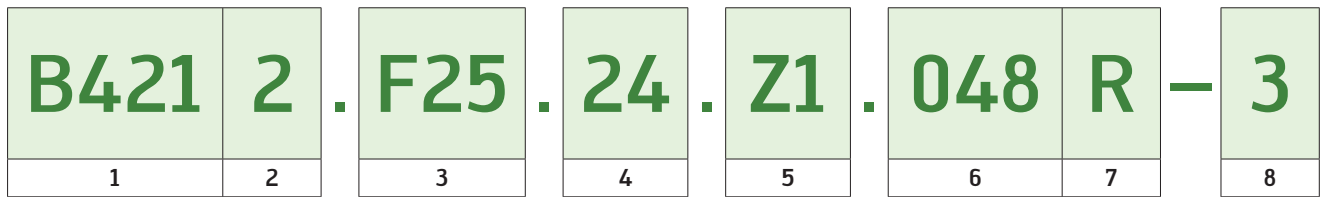

1
Walter drill designation

2
Drilling depth (L/D ratio)
2 2 x D _c
3 3 x D _c
4 4 x D _c
5 5 x D _c

3
Shank variants and diameters
F Cylindrical shank with clamping surface
UF Inch
N NCT
DF Combi-shank DIN 1835 B and DIN 6535 HE
C Walter Capto™ ISO 26623
T ScrewFit

4
Nominal diameter [mm]

5
Effective number of teeth

6
Drilling depth [mm]

7
Cutting direction
R right handed

8
Insert size

Walter Select for drilling inserts

Step by step to the right indexable insert

STEP 1





Define the **material** to be machined from page H 8 onwards of the General catalogue.

Note the machining group that corresponds to your material e.g.: P10.

Code letter	Machining group	Groups of the materials to be machined	
P	P1–P15	Steel	All types of steel and cast steel, with the exception of steel with an austenitic structure
M	M1–M3	Stainless steel	Stainless austenitic steel and austenitic-ferritic steel and cast steel
K	K1–K7	Cast iron	Grey cast iron, cast iron with spheroidal graphite, malleable cast iron, cast iron with vermicular graphite
N	N1–N10	NF metals	Aluminium and other non-ferrous metals, non-ferrous materials
S	S1–S10	High temperature alloys and titanium alloys	Heat resisting special alloys based on iron, nickel and cobalt, titanium and titanium alloys
H	H1–H4	Hard materials	Hardened steel, hardened cast iron materials, chilled cast iron
O	O1–O6	Other	Plastics, glass- and carbon fibre reinforced plastics, graphite

STEP 2

Select the **machining conditions**:

Tool projection	Machine stability, clamping system and workpiece		
	very good	good	moderate
Short projection length			
Extended tool projection			

STEP 3

Select your **tool** according to your application and individual requirements. Then select your drill from the corresponding tool page.

Drilling depth	Page
1 x D _C	<i>C 50*</i>
2 x D _C	<i>C 52*</i>
3 x D _C	<i>C 64*</i>
4 x D _C	<i>C 74*</i>
5 x D _C	<i>C 80*</i>
7 x D _C	C-40
10 x D _C	<i>C 88*</i>

* The pages indicated in italics refer to the Walter General catalogue 2012.

STEP 4

Determine your optimum **indexable insert grade and geometry** on the appropriate tool page. In so doing, please take into consideration the machining conditions (step 2) and the material to be machined.

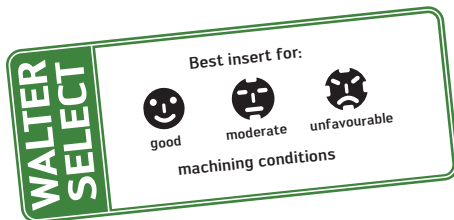

Drill inserts P6001, P6002, P6003, P6004 for Xtra-tec® Point Drill

Drill inserts							P6001	P6003	P6003	P6002	P6004	P6003	
Designation	Cutting edges	D _c mm	D _c Inches/No	d ₁ mm	s mm	P6001		P6003		P6004		P6003	
						HC	WXP 45	HC	WPP 45C	HC	M WMP 35	HC	K WXX 25
P6001	P60 ...-D12.00R*	2	12.00		3	3.6	●	●	●	●	●	●	●
	P60 ...-D12.10R	2	12.10		3	3.6	●	●	●	●	●	●	●
	P60 ...-D12.20R	2	12.20		3	3.6	●	●	●	●	●	●	●
	P60 ...-D12.30R	2	12.30		3	3.6	●	●	●	●	●	●	●
	P60 ...-D12.40R	2	12.40		3	3.6	●	●	●	●	●	●	●
P6002	P60 ...-D12.50R	2	12.50		3	3.6	●	●	●	●	●	●	●
	P60 ...-D12.60R	2	12.60		3	3.6	●	●	●	●	●	●	●
	P60 ...-D12.70R	2	12.70	1/2"	3	3.6	●	●	●	●	●	●	●
	P60 ...-D12.80R	2	12.80		3	3.6	●	●	●	●	●	●	●
	P60 ...-D12.90R	2	12.90		3	3.6	●	●	●	●	●	●	●
P6003	P60 ...-D12.95R	2	12.95		3	3.6	●	●	●	●	●	●	●
	P60 ...-D13.00R	2	13.00		3	3.6	●	●	●	●	●	●	●
	P60 ...-D13.11R	2	13.11	33/64"	3	3.6	●	●	●	●	●	●	●

STEP 5

Select the **cutting data** from page C-76 onwards.

Cutting data for drilling with Xtra-tec® Point Drill D_C 12–38 mm

= Cutting data for wet machining
 = Dry machining is possible

Material group	Structure of main material groups and code letters	Brinell hardness HB	Tensile strength R _m N/mm ²	Machining group	Insert geometry						
					Starting values for feed f [mm/U]						
					P6001						
					D _c (mm)						
P	Non-alloyed steel	C ≤ 0.25%	annealed	125-428	P1	●	●	0.2	0.25	0.3	0.4
		C > 0.25% - < 0.55%	annealed	190-639	P2	●	●	0.2	0.25	0.3	0.4
		C > 0.25% ≤ 0.55%	tempered	210-708	P3	●	●	0.2	0.25	0.3	0.4
		C > 0.55%	annealed	190-639	P4	●	●	0.2	0.25	0.3	0.4
		C > 0.55%	tempered	300-1013	P5	●	●	0.15	0.2	0.22	0.25
	Low-alloyed steel	machining steel (short-chipping)	annealed	220-745	P6	●	●	0.18	0.22	0.25	0.3
		annealed	175-591	P7	●	●	0.2	0.25	0.3	0.4	
		tempered	300-1013	P8	●	●	0.2	0.25	0.3	0.4	
		tempered	380-1282	P9	●	●	0.18	0.22	0.25	0.3	
		tempered	430-1477	P10	●	●	0.15	0.2	0.22	0.28	
High-alloyed steel and high-alloyed tool steel	annealed	200-675	P11	●	●	0.15	0.2	0.22	0.28		
	hardened and tempered	300-1013	P12	●	●	0.12	0.15	0.2	0.25		
	hardened and tempered	400-1361	P13	●	●	0.1	0.12	0.2	0.22		
Stainless steel	ferritic/martensitic, annealed	200-575	P14	●	●	0.15	0.2	0.22	0.2		
	martensitic, tempered	330-1114	P15	●	●	0.2	0.25	0.3	0.4		
	austenitic, quench hardened	200-675	M1	●	●						
M	austenitic, precipitation hardened (PH)	300-1013	M2	●	●						
	austenitic/ferritic, duplex	230-778	M3	●	●						
	Malleable cast iron	ferritic	200-675	K1	●	●	0.2	0.25	0.3	0.4	
		260-867	K2	●	●	0.2	0.25	0.3	0.4		

Drill inserts

P6001, P6002, P6003, P6004

for Xtra-tec® Point Drill

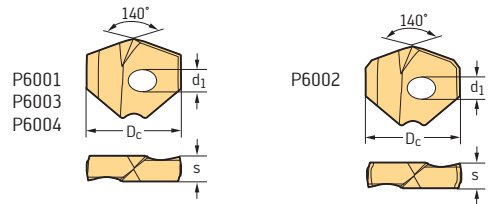

Drill inserts

Designation	Cutting edges	D _c mm	D _c Inches/ No	d ₁ mm	s mm	P6001		P6003	P6003	P6002	P6004	P6003	
						P HC		P HC	M HC	K HC	N HC	S HC	
						WXP 45	WPP45C	WMP 35	WMP 35	WXK 25	WNN 25	WMP 35	
 P6001	P60...-D12,00R*	2	12,00		3	3,6							
	P60...-D12,10R	2	12,10		3	3,6							
	P60...-D12,20R	2	12,20		3	3,6							
	P60...-D12,30R	2	12,30		3	3,6							
	P60...-D12,40R	2	12,40		3	3,6							
 P6002	P60...-D12,50R	2	12,50		3	3,6							
	P60...-D12,60R	2	12,60		3	3,6							
	P60...-D12,70R	2	12,70	1/2"	3	3,6							
	P60...-D12,80R	2	12,80		3	3,6							
	P60...-D12,90R	2	12,90		3	3,6							
 P6003	P60...-D12,95R	2	12,95		3	3,6							
	P60...-D13,00R	2	13,00		3	3,6							
	P60...-D13,11R	2	13,11	33/64"	3	3,6							
	P60...-D13,20R	2	13,20		3	3,6							
	P60...-D13,25R	2	13,25		3	3,6							
 P6004	P60...-D13,30R	2	13,30		3	3,6							
	P60...-D13,40R	2	13,40		3	3,6							
	P60...-D13,50R	2	13,50	17/32"	3	3,6							
	P60...-D13,60R	2	13,60		3	3,6							
	P60...-D13,70R	2	13,70		3	3,6							
	P60...-D13,80R	2	13,80		3	3,6							
	P60...-D13,89R	2	13,89	35/64"	3	3,6							
	P60...-D14,00R	2	14,00		3	4,0							
	P60...-D14,10R	2	14,10		3	4,0							
	P60...-D14,20R	2	14,20		3	4,0							
	P60...-D14,30R	2	14,30	9/16"	3	4,0							
	P60...-D14,40R	2	14,40		3	4,0							
	P60...-D14,50R	2	14,50		3	4,0							
	P60...-D14,60R	2	14,60		3	4,0							
	P60...-D14,68R	2	14,68	37/64"	3	4,0							
	P60...-D14,80R	2	14,80		3	4,0							
	P60...-D14,90R	2	14,90		3	4,0							
	P60...-D15,00R	2	15,00		3	4,0							
	P60...-D15,09R	2	15,09	19/32"	3	4,0							
	P60...-D15,20R	2	15,20		3	4,0							
P60...-D15,30R	2	15,30		3	4,0								
P60...-D15,40R	2	15,40		3	4,0								
P60...-D15,47R	2	15,47	39/64"	3	4,0								
P60...-D15,50R	2	15,50		3	4,0								
P60...-D15,60R	2	15,60		3	4,0								
P60...-D15,70R	2	15,70		3	4,0								
P60...-D15,80R	2	15,80		3	4,0								
P60...-D15,87R	2	15,87	5/8"	3	4,0								
P60...-D16,00R	2	16,00		4	4,5								
P60...-D16,13R	2	16,13		4	4,5								
P60...-D16,26R	2	16,26	41/64"	4	4,5								
P60...-D16,43R	2	16,43		4	4,5								
P60...-D16,50R	2	16,50		4	4,5								

*Order example:

P60...-D13,00R is available as P6003 in grade WMP 35 (ISO P, ISO M and ISO S) → P6003-D13,00R WMP 35
or as P6001 in grade WXP 45 (ISO P) → P6001-D13,00R WXP 45

New addition to range

Drill inserts P6001, P6002, P6003, P6004 for Xtra-tec® Point Drill

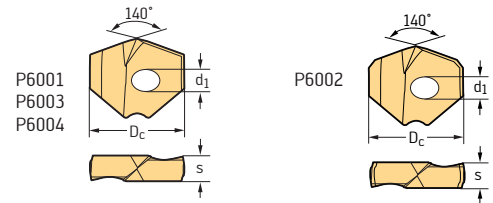

Drill inserts

Designation	Cutting edges	D _c mm	D _c Inches/No	d ₁ mm	s mm	P6001		P6003	P6003	P6002	P6004	P6003	
						P		P	M	K	N	S	
						HC	HC	HC	HC	HC	HC		
						WXP 45	WPP45C	WMP 35	WMP 35	WXK 25	WNN 25	WMP 35	
P6001 	P60...-D16,66R	2	16,66	21/32"	4	4,5							
	P60...-D16,70R	2	16,70		4	4,5							
	P60...-D17,00R	2	17,00		4	4,5							
	P60...-D17,07R	2	17,07	43/64"	4	4,5							
	P60...-D17,45R	2	17,45	11/16"	4	4,5							
P6002 	P60...-D17,50R	2	17,50		4	4,5							
	P60...-D17,70R	2	17,70		4	4,5							
	P60...-D17,86R*	2	17,86	45/64"	4	4,5							
	P60...-D18,00R	2	18,00		4	5,0							
	P60...-D18,24R	2	18,24	23/32"	4	5,0							
P6003 	P60...-D18,50R	2	18,50		4	5,0							
	P60...-D18,65R	2	18,65	47/64N	4	5,0							
	P60...-D18,70R	2	18,70		4	5,0							
	P60...-D18,80R	2	18,80		4	5,0							
	P60...-D19,00R	2	19,00		4	5,0							
P6004 	P60...-D19,05R	2	19,05	3/4"	4	5,0							
	P60...-D19,20R	2	19,20		4	5,0							
	P60...-D19,25R	2	19,25		4	5,0							
	P60...-D19,30R	2	19,30		4	5,0							
	P60...-D19,43R	2	19,43	49/64"	4	5,0							
	P60...-D19,50R	2	19,50		4	5,0							
	P60...-D19,60R	2	19,60		4	5,0							
	P60...-D19,70R	2	19,70		4	5,0							
	P60...-D19,84R	2	19,84	25/32"	4	5,0							
	P60...-D20,00R	2	20,00		5	5,5							
	P60...-D20,20R	2	20,20		5	5,5							
	P60...-D20,24R	2	20,24	51/64"	5	5,5							
	P60...-D20,50R	2	20,50		5	5,5							
	P60...-D20,62R	2	20,62	13/16"	5	5,5							
	P60...-D20,70R	2	20,70		5	5,5							
	P60...-D21,00R	2	21,00		5	5,5							
	P60...-D21,41R	2	21,41	27/32"	5	5,5							
	P60...-D21,50R	2	21,50		5	5,5							
	P60...-D21,70R	2	21,70		5	5,5							
	P60...-D21,83R	2	21,83		5	5,5							
P60...-D22,00R	2	22,00		5	6,0								
P60...-D22,22R	2	22,22	7/8"	5	6,0								
P60...-D22,42R	2	22,42		5	6,0								
P60...-D22,47R	2	22,47		5	6,0								
P60...-D22,50R	2	22,50		5	6,0								
P60...-D22,62R	2	22,62		5	6,0								
P60...-D22,70R	2	22,70		5	6,0								
P60...-D22,77R	2	22,77		5	6,0								
P60...-D23,00R	2	23,00	29/32"	5	6,0								
P60...-D23,39R	2	23,39		5	6,0								
P60...-D23,50R	2	23,50		5	6,0								
P60...-D23,70R	2	23,70		5	6,0								

*Order example:

P60...-D13.00R is available as P6003 in grade WMP 35 (ISO P, ISO M and ISO S) → **P6003-D13.00R WMP 35**
or as P6001 in grade WXP 45 (ISO P) → **P6001-D13.00R WXP 45**

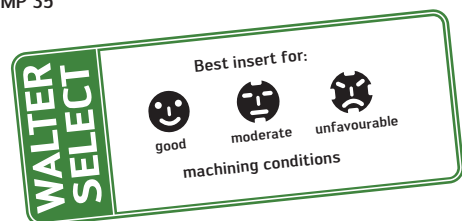

Drill inserts

P6001, P6002, P6003, P6004

for Xtra-tec® Point Drill

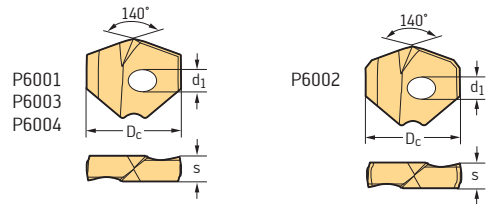

Drill inserts

Designation	Cutting edges	D _c mm	D _c Inches/ No	d ₁ mm	s mm	P6001		P6003	P6003	P6002	P6004	P6003
						P HC		P HC	M HC	K HC	N HC	S HC
						WXP 45	WPP45C	WMP 35	WMP 35	WXK 25	WNN 25	WMP 35
P6001 	P60...-D23,80R	2	23,80	15/16"	5	6,0						
	P60...-D24,00R	2	24,00		5	6,5						
	P60...-D24,21R	2	24,21		5	6,5						
	P60...-D24,50R	2	24,50		5	6,5						
	P60...-D24,59R	2	24,59	31/32"	5	6,5						
P6002 	P60...-D24,70R	2	24,70		5	6,5						
	P60...-D25,00R	2	25,00		5	6,5						
	P60...-D25,25R	2	25,25		5	6,5						
	P60...-D25,40R	2	25,40	1"	5	6,5						
	P60...-D25,50R	2	25,50		5	6,5						
P6003 	P60...-D25,65R	2	25,65		5	6,5						
	P60...-D25,70R	2	25,70		5	6,5						
	P60...-D25,80R	2	25,80		5	6,5						
	P60...-D26,00R	2	26,00		6	7,1						
	P60...-D26,25R	2	26,25		6	7,1						
P6004 	P60...-D26,50R	2	26,50		6	7,1						
	P60...-D26,59R	2	26,59		6	7,1						
	P60...-D27,00R	2	27,00		6	7,1						
	P60...-D27,38R	2	27,38		6	7,1						
	P60...-D27,50R	2	27,50		6	7,1						
	P60...-D27,78R	2	27,78		6	7,1						
	P60...-D28,00R	2	28,00		6	7,7						
	P60...-D28,17R	2	28,17		6	7,7						
	P60...-D28,50R	2	28,50		6	7,7						
	P60...-D28,57R	2	28,57		6	7,7						
	P60...-D29,00R	2	29,00		6	7,7						
	P60...-D29,37R	2	29,37		6	7,7						
	P60...-D29,50R	2	29,50		6	7,7						
	P60...-D29,77R	2	29,77		6	7,7						
	P60...-D30,00R	2	30,00		6	8,0						
P60...-D30,15R	2	30,15		6	8,0							
P60...-D30,50R	2	30,50		6	8,0							
P60...-D31,00R	2	31,00		6	8,0							
P60...-D31,50R	2	31,50		6	8,0							
P60...-D31,75R	2	31,75		6	8,0							
P60...-D31,99R	2	31,99		6	8,0							
P60...-D32,00R	2	32,00		6,2	8,29							
P60...-D32,10R	2	32,10		6,2	8,29							
P60...-D33,00R	2	33,00		6,2	8,29							
P60...-D34,00R	2	34,00		6,2	8,29							
P60...-D35,00R	2	35,00		6,2	8,29							
P60...-D36,00R	2	36,00		6,2	8,29							
P60...-D37,00R	2	37,00		6,2	8,29							
P60...-D37,99R	2	37,99		6,2	8,29							

*Order example:

P60...-D13.00R is available as P6003 in grade WMP 35 (ISO P, ISO M and ISO S) → P6003-D13.00R WMP 35
or as P6001 in grade WXP 45 (ISO P) → P6001-D13.00R WXP 45

New addition to range

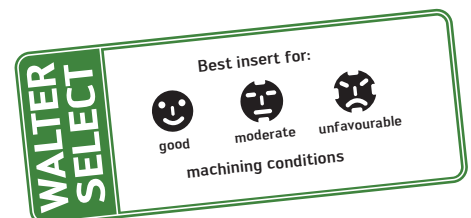

Positive basic shape TCGT/TCMT/TCMW

Tiger-tec®

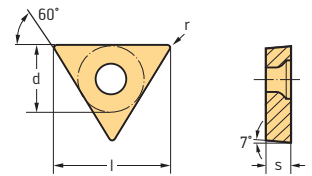

Indexable inserts

Designation	d mm	l mm	s mm	r mm	P				M			K			N		S		
					HC				HC			HC			HC	HW	HC		
					WPP01	WPP10	WPP20	WPP30	WSM10	WSM20	WSM21	WSM30	WAK10	WAK20	WAK30	WXN10	WK1	WSM10	WSM20
TCMT06T102-PF4	3,97	6,9	1,98	0,2															
TCMT06T104-PF4	3,97	6,9	1,98	0,4															
TCMT090202-PF4	5,56	9	2,38	0,2	☺	☺	☺	☺	☺	☺									
TCMT090204-PF4	5,56	9	2,38	0,4	☺	☺	☺	☺	☺	☺									
TCMT090208-PF4	5,56	9	2,38	0,8	☺	☺	☺	☺	☺	☺									
TCMT110202-PF4	6,35	11	2,38	0,2	☺	☺	☺	☺	☺	☺									
TCMT110204-PF4	6,35	11	2,38	0,4	☺	☺	☺	☺	☺	☺									
TCMT110208-PF4	6,35	11	2,38	0,8	☺	☺	☺	☺	☺	☺									
TCMT16T302-PF4	9,525	16,5	3,97	0,2	☺	☺	☺	☺	☺	☺									
TCMT16T304-PF4	9,525	16,5	3,97	0,4	☺	☺	☺	☺	☺	☺									
TCMT16T308-PF4	9,525	16,5	3,97	0,8	☺	☺	☺	☺	☺	☺									
TCMT110204-PS5	6,35	11	2,38	0,4							☺	☺							
TCMT110208-PS5	6,35	11	2,38	0,8							☺	☺							
TCMT16T304-PS5	9,525	16,5	3,97	0,4							☺	☺							
TCMT16T308-PS5	9,525	16,5	3,97	0,8							☺	☺							
TCGT110201-PM2	6,35	11	2,38	0,1									☺	☺					
TCGT110202-PM2	6,35	11	2,38	0,2									☺	☺					
TCGT110204-PM2	6,35	11	2,38	0,4									☺	☺					
TCGT16T302-PM2	9,525	16,5	3,97	0,2									☺	☺					
TCGT16T304-PM2	9,525	16,5	3,97	0,4									☺	☺					
TCGT16T308-PM2	9,525	16,5	3,97	0,8									☺	☺					
TCMT090204-PM5	5,56	9	2,38	0,4		☺	☺	☺		☺	☺	☺	☺						☺
TCMT090208-PM5	5,56	9	2,38	0,8		☺	☺	☺		☺	☺	☺	☺						☺
TCMT110204-PM5	6,35	11	2,38	0,4		☺	☺	☺	☺	☺	☺	☺	☺						☺
TCMT110208-PM5	6,35	11	2,38	0,8		☺	☺	☺	☺	☺	☺	☺	☺						☺
TCMT16T304-PM5	9,525	16,5	3,97	0,4		☺	☺	☺	☺	☺	☺	☺	☺						☺
TCMT16T308-PM5	9,525	16,5	3,97	0,8		☺	☺	☺	☺	☺	☺	☺	☺						☺
TCMT16T312-PM5	9,525	16,5	3,97	1,2		☺	☺	☺	☺	☺	☺	☺	☺						☺
TCMW110202	6,35	11	2,38	0,2									☺	☺					
TCMW110204	6,35	11	2,38	0,4									☺	☺					
TCMW110208	6,35	11	2,38	0,8									☺	☺					
TCMW16T304	9,525	16,5	3,97	0,4									☺	☺					
TCMW16T308	9,525	16,5	3,97	0,8									☺	☺					
TCMW16T312	9,525	16,5	3,97	1,2									☺	☺					

HC = Coated carbide
HW = Uncoated carbide

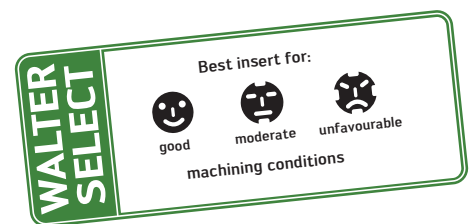



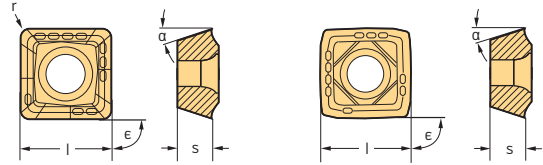

Square insert P 484 .

Tiger-tec®

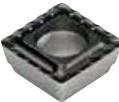

Indexable inserts



	Designation	Number of cutting edges	l mm	s mm	r mm	α	ε	P		M	K		S	HC
								HC	WKP25S	HC	WKP25S	HC	WKP35S	
Outer insert 	P4840P-1R-A57	4	4,55	1,96	0,29	11°	90°	⊕	⊕	⊕	⊕	⊕	⊕	⊕
	P4840P-2R-A57	4	5,52	2,38	0,34	11°	90°	⊕	⊕	⊕	⊕	⊕	⊕	⊕
	P4840P-3R-A57	4	6,5	2,8	0,4	11°	90°	⊕	⊕	⊕	⊕	⊕	⊕	⊕
	P4840P-4R-A57	4	7,8	3,36	0,48	11°	90°	⊕	⊕	⊕	⊕	⊕	⊕	⊕
	P4840P-5R-A57	4	9,56	4,12	0,59	11°	90°	⊕	⊕	⊕	⊕	⊕	⊕	⊕
	P4840P-6R-A57	4	11,75	4,87	0,7	11°	90°	⊕	⊕	⊕	⊕	⊕	⊕	⊕
	P4840P-7R-A57	4	14,03	5,53	0,8	11°	90°	⊕	⊕	⊕	⊕	⊕	⊕	⊕
	P4840P-8R-A57	4	16,5	5,53	1	11°	90°	⊕	⊕	⊕	⊕	⊕	⊕	⊕
Outer insert 	P4840P-1R-E57	4	4,55	1,96	0,29	11°	90°	⊕	⊕	⊕	⊕	⊕	⊕	⊕
	P4840P-2R-E57	4	5,52	2,38	0,34	11°	90°	⊕	⊕	⊕	⊕	⊕	⊕	⊕
	P4840P-3R-E57	4	6,5	2,8	0,4	11°	90°	⊕	⊕	⊕	⊕	⊕	⊕	⊕
	P4840P-4R-E57	4	7,8	3,36	0,48	11°	90°	⊕	⊕	⊕	⊕	⊕	⊕	⊕
	P4840P-5R-E57	4	9,56	4,12	0,59	11°	90°	⊕	⊕	⊕	⊕	⊕	⊕	⊕
	P4840P-6R-E57	4	11,75	4,87	0,7	11°	90°	⊕	⊕	⊕	⊕	⊕	⊕	⊕
	P4840P-7R-E57	4	14,03	5,53	0,8	11°	90°	⊕	⊕	⊕	⊕	⊕	⊕	⊕
	P4840P-8R-E57	4	16,5	5,53	1	11°	90°	⊕	⊕	⊕	⊕	⊕	⊕	⊕
Outer insert 	P4840P-1R-E67	4	4,55	1,96	0,29	11°	90°	⊕	⊕	⊕	⊕	⊕	⊕	⊕
	P4840P-2R-E67	4	5,52	2,38	0,34	11°	90°	⊕	⊕	⊕	⊕	⊕	⊕	⊕
	P4840P-3R-E67	4	6,5	2,8	0,4	11°	90°	⊕	⊕	⊕	⊕	⊕	⊕	⊕
	P4840P-4R-E67	4	7,8	3,36	0,48	11°	90°	⊕	⊕	⊕	⊕	⊕	⊕	⊕
	P4840P-5R-E67	4	9,56	4,12	0,59	11°	90°	⊕	⊕	⊕	⊕	⊕	⊕	⊕
	P4840P-6R-E67	4	11,75	4,87	0,7	11°	90°	⊕	⊕	⊕	⊕	⊕	⊕	⊕
	P4840P-7R-E67	4	14,03	5,53	0,8	11°	90°	⊕	⊕	⊕	⊕	⊕	⊕	⊕
	P4840P-8R-E67	4	16,5	5,53	1	11°	90°	⊕	⊕	⊕	⊕	⊕	⊕	⊕
Outer insert 	P4841P-1R-A57	4	4,55	1,96	0,29	11°	90°	⊕	⊕	⊕	⊕	⊕	⊕	⊕
	P4841P-2R-A57	4	5,52	2,38	0,34	11°	90°	⊕	⊕	⊕	⊕	⊕	⊕	⊕
	P4841P-3R-A57	4	6,5	2,8	0,4	11°	90°	⊕	⊕	⊕	⊕	⊕	⊕	⊕
	P4841P-4R-A57	4	7,8	3,36	0,48	11°	90°	⊕	⊕	⊕	⊕	⊕	⊕	⊕
	P4841P-5R-A57	4	9,56	4,12	0,59	11°	90°	⊕	⊕	⊕	⊕	⊕	⊕	⊕
	P4841P-6R-A57	4	11,75	4,87	0,7	11°	90°	⊕	⊕	⊕	⊕	⊕	⊕	⊕
	P4841P-7R-A57	4	14,03	5,53	0,8	11°	90°	⊕	⊕	⊕	⊕	⊕	⊕	⊕
	P4841P-8R-A57	4	16,5	5,53	1	11°	90°	⊕	⊕	⊕	⊕	⊕	⊕	⊕
Outer insert 	P4841P-1R-E57	4	4,55	1,96	0,29	11°	90°	⊕	⊕	⊕	⊕	⊕	⊕	⊕
	P4841P-2R-E57	4	5,52	2,38	0,34	11°	90°	⊕	⊕	⊕	⊕	⊕	⊕	⊕
	P4841P-3R-E57	4	6,5	2,8	0,4	11°	90°	⊕	⊕	⊕	⊕	⊕	⊕	⊕
	P4841P-4R-E57	4	7,8	3,36	0,48	11°	90°	⊕	⊕	⊕	⊕	⊕	⊕	⊕
	P4841P-5R-E57	4	9,56	4,12	0,59	11°	90°	⊕	⊕	⊕	⊕	⊕	⊕	⊕
	P4841P-6R-E57	4	11,75	4,87	0,7	11°	90°	⊕	⊕	⊕	⊕	⊕	⊕	⊕
	P4841P-7R-E57	4	14,03	5,53	0,8	11°	90°	⊕	⊕	⊕	⊕	⊕	⊕	⊕
	P4841P-8R-E57	4	16,5	5,53	1	11°	90°	⊕	⊕	⊕	⊕	⊕	⊕	⊕

HC = Coated carbide

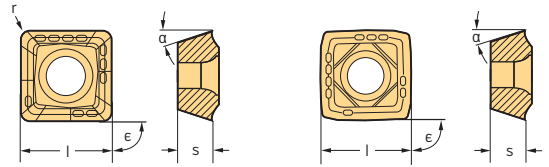
Square insert P 484 . Tiger-tec®



Indexable inserts

Designation	Number of cutting edges	l mm	s mm	r mm	α	ε	P		M		K		S		HC
							WKP25S	WKP35S	WSP45	WSP45	WKP25S	WKP35S	WSP45	WXP40	
Centre insert 	P4841C-1R-A57	4	4,9	1,96	0,29	11°	90°	✘	✘	✘	✘	✘	✘	✘	✘
	P4841C-2R-A57	4	5,95	2,38	0,34	11°	90°	✘	✘	✘	✘	✘	✘	✘	✘
	P4841C-3R-A57	4	7	2,8	0,4	11°	90°	✘	✘	✘	✘	✘	✘	✘	✘
	P4841C-4R-A57	4	8,4	3,36	0,48	11°	90°	✘	✘	✘	✘	✘	✘	✘	✘
	P4841C-5R-A57	4	10,29	4,12	0,59	11°	90°	✘	✘	✘	✘	✘	✘	✘	✘
	P4841C-6R-A57	4	12,24	4,87	0,7	11°	90°	✘	✘	✘	✘	✘	✘	✘	✘
	P4841C-7R-A57	4	14,69	5,53	0,8	11°	90°	✘	✘	✘	✘	✘	✘	✘	✘
	P4841C-8R-A57	4	17,49	5,53	1	11°	90°	✘	✘	✘	✘	✘	✘	✘	✘
Centre insert 	P4841C-1R-E57	4	4,9	1,96	0,29	11°	90°	✘	✘	✘	✘	✘	✘	✘	✘
	P4841C-2R-E57	4	5,95	2,38	0,34	11°	90°	✘	✘	✘	✘	✘	✘	✘	✘
	P4841C-3R-E57	4	7	2,8	0,4	11°	90°	✘	✘	✘	✘	✘	✘	✘	✘
	P4841C-4R-E57	4	8,4	3,36	0,48	11°	90°	✘	✘	✘	✘	✘	✘	✘	✘
	P4841C-5R-E57	4	10,29	4,12	0,59	11°	90°	✘	✘	✘	✘	✘	✘	✘	✘
	P4841C-6R-E57	4	12,24	4,87	0,7	11°	90°	✘	✘	✘	✘	✘	✘	✘	✘
	P4841C-7R-E57	4	14,69	5,53	0,8	11°	90°	✘	✘	✘	✘	✘	✘	✘	✘
	P4841C-8R-E57	4	17,49	5,53	1	11°	90°	✘	✘	✘	✘	✘	✘	✘	✘
Centre insert 	P4840C-1R-E67	4	4,9	1,96	0,29	11°	90°	✘	✘	✘	✘	✘	✘	✘	✘
	P4840C-2R-E67	4	5,95	2,38	0,34	11°	90°	✘	✘	✘	✘	✘	✘	✘	✘
	P4840C-3R-E67	4	7	2,8	0,4	11°	90°	✘	✘	✘	✘	✘	✘	✘	✘
	P4840C-4R-E67	4	8,4	3,36	0,48	11°	90°	✘	✘	✘	✘	✘	✘	✘	✘
	P4840C-5R-E67	4	10,29	4,12	0,59	11°	90°	✘	✘	✘	✘	✘	✘	✘	✘
	P4840C-6R-E67	4	12,24	4,87	0,7	11°	90°	✘	✘	✘	✘	✘	✘	✘	✘
	P4840C-7R-E67	4	14,69	5,53	0,8	11°	90°	✘	✘	✘	✘	✘	✘	✘	✘
	P4840C-8R-E67	4	17,49	5,53	1	11°	90°	✘	✘	✘	✘	✘	✘	✘	✘

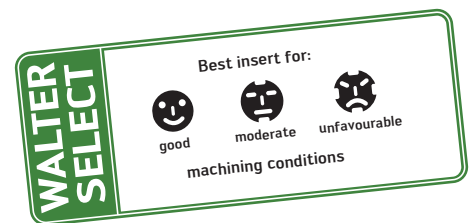

HC = Coated carbide

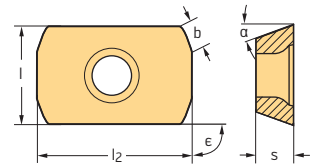

Rectangular insert LCMX Tiger-tec®



Indexable inserts

Designation	Number of cutting edges	l mm	l ₂ mm	s mm	r mm	α	b mm	ε	P					M	K			S					
									HC					HC	HC	HC	HC	HC					
									WAP20	WKP25	WKP35	WTP35	WKP25S	WKP35S	WSP45	WSP45	WKP25	WKP35	WKP25S	WKP35S	WSP45	WXP40	
 LCMX050203-B57 LCMX06T204-B57	2	4	5,2	2,38	0,2	7°	0,6	90°			☞	☞					☞	☞				☞	☞
	2	5,2	6,6	2,78	0,2	7°	0,8	90°			☞	☞					☞	☞				☞	☞
 LCMX050203-D57 LCMX06T204-D57	2	4	5,2	2,38	0,2	7°	0,6	90°	☞	☞	☞	☞			☞	☞	☞	☞				☞	☞
	2	5,2	6,6	2,78	0,2	7°	0,8	90°	☞	☞	☞	☞			☞	☞	☞	☞				☞	☞
 LCMX050203-E57 LCMX06T204-E57	2	4	5,2	2,38	0,2	7°	0,6	90°	☞						☞	☞						☞	☞
	2	5,2	6,6	2,78	0,2	7°	0,8	90°	☞						☞	☞						☞	☞

HC = Coated carbide

Trigon indexable inserts WOMX/WOEX

Tiger-tec®

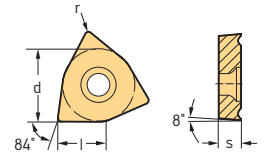

Indexable inserts

Designation	Number of cutting edges	l mm	s mm	r mm	d mm	P		M		K		S		HC		
						HC	HC	HC	HC	HC	HC	HC	HC			
						WKP255	WKP355	WSP45	WSP45	WAK15	WKP255	WKP355	WSP45	WXP40		
	WOMX030204-B57	3	3,31	2,3	0,4	5	☹	☹								
	WOMX040304-B57	3	4,2	3,18	0,4	6,35	☹	☹								
	WOMX05T304-B57	3	5,29	3,8	0,4	8	☹	☹								
	WOMX06T304-B57	3	6,62	3,8	0,4	10	☹	☹								
	WOMX080408-B57	3	7,94	4,8	0,8	12	☹	☹								
	WOMX100508-B57	3	9,92	5,3	0,8	15	☹	☹								
	WOMX120608-B57	3	11,64	6	0,8	17,6	☹	☹								
	WOMX030204-D57	3	3,31	2,3	0,4	5	☹	☹							☹	
	WOMX040304-D57	3	4,2	3,18	0,4	6,35	☹	☹							☹	
	WOMX05T304-D57	3	5,29	3,8	0,4	8	☹	☹		☹					☹	
	WOMX06T304-D57	3	6,62	3,8	0,4	10	☹	☹		☹					☹	
	WOMX080408-D57	3	7,94	4,8	0,8	12	☹	☹		☹					☹	
	WOMX100508-D57	3	9,92	5,3	0,8	15	☹	☹		☹					☹	
	WOMX120608-D57	3	11,64	6	0,8	17,6	☹	☹		☹					☹	
	WOEX030204-E57	3	3,31	2,3	0,4	5	☹	☹								
	WOEX040304-E57	3	4,2	3,18	0,4	6,35	☹	☹								
	WOEX05T304-E57	3	5,29	3,8	0,4	8	☹	☹								
	WOEX06T304-E57	3	6,62	3,8	0,4	10	☹	☹		☹						
	WOEX080408-E57	3	7,94	4,8	0,8	12	☹	☹								
	WOEX100508-E57	3	9,92	5,3	0,8	15	☹	☹								
	WOEX120608-E57	3	11,64	6	0,8	17,6	☹	☹								

HC = Coated carbide

WALTER SELECT

Best insert for:

good

moderate

unfavourable

machining conditions

☹ ☹ ☹ New addition to range



Walter Select for indexable inserts for counterboring

Step by step to the right indexable insert

STEP 1













Determine the **material** to be machined from page H 8 in the Walter General catalogue 2012.

Note the machining group that corresponds to your material e.g.: P10.

Code letter	Machining group	Groups of the materials to be machined	
P	P1–P15	Steel	All types of steel and cast steel, with the exception of steel with an austenitic structure
M	M1–M3	Stainless steel	Stainless austenitic steel, austenitic-ferritic steel and cast steel
K	K1–K7	Cast iron	Grey cast iron, cast iron with spheroidal graphite, malleable cast iron, cast iron with vermicular graphite
N	N1–N10	NF metals	Aluminium and other non-ferrous metals, non-ferrous materials
S	S1–S10	High temperature alloys and titanium alloys	Heat resisting special alloys based on iron, nickel and cobalt, titanium and titanium alloys
H	H1–H4	Hard materials	Hardened steel, hardened cast iron materials, chilled cast iron
O	O1–O6	Other	Plastics, glass- and carbon fibre reinforced plastics, graphite

STEP 2

Select the **machining conditions**:

Type of cutting action	Machine stability, clamping system and workpiece		
	very good	good	moderate
Smooth cut, premachined surface			
Cast or forged skin Varying cutting depths Slight interrupted cuts			
Medium interrupted cuts			
Heavily interrupted cuts			

STEP 3

Determine the insert geometry via the cutting depth (a_p) and the feed (f_z).

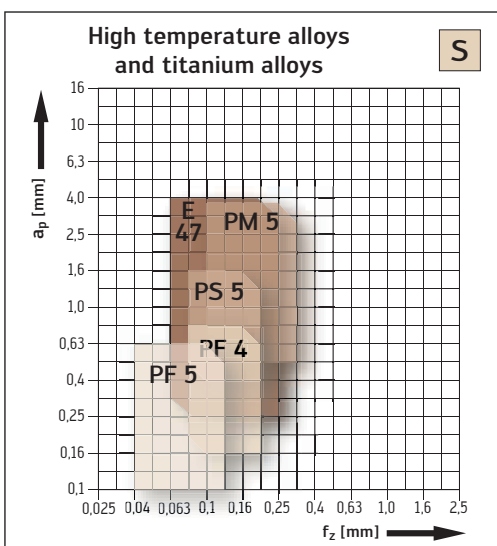
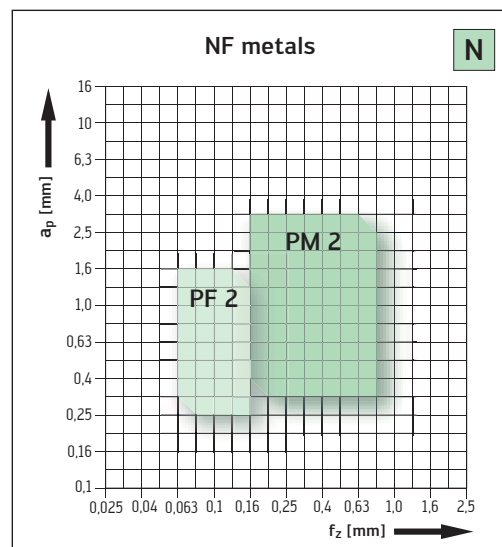
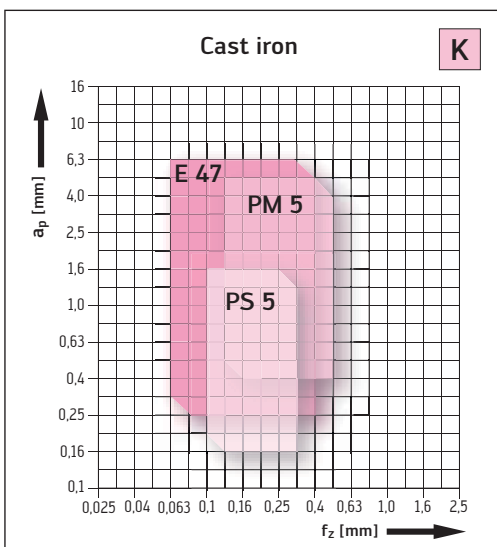
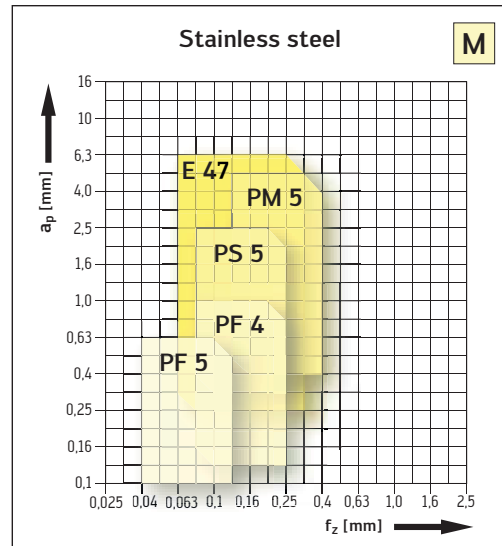
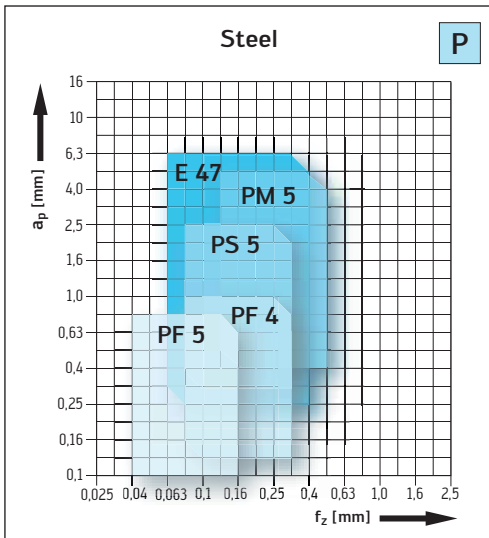

Walter Select for indexable inserts for counterboring

Step by step to the right indexable insert

STEP 4

Determine the **cutting tool material** by means of the indexable insert geometry and the machining conditions:

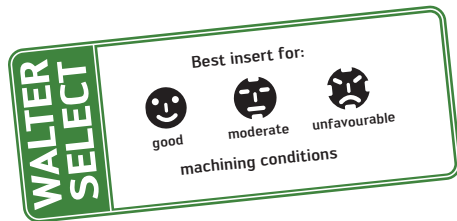

Code letter	Machining group	Ø accuracy	Walter Indexable insert geometry	Machining conditions		
				☺	☹	☹☹
P	P1-P15	medium	E 47	WPP 20	WPP 20	WSM 20
			PM 5	WPP 10	WPP 20	WPP30 / WSM 20
			PS 5	WPP 10	WPP 20	WPP 20 / WSM 20
			PF 4	WPP 01	WPP 10 / WPP 20	WPP 20 / WSM 20
		high	PF 5	WPP 20	WPP 20	WPP 30 / WSM 20
			PF 2	WSM 20	WSM 20	WSM 20
M	M1-M3	medium	E 47	WSM 20	WSM 20	WSM 20
			PM 5	WSM 10 / WSM 20	WSM 20	WSM 30
			PS 5	WSM 20	WSM 20	WSM 30
			PF 4	WSM 10 / WSM 20	WSM 20	WSM 30
		high	PF 5	WSM 30	WSM 30	WSM 30
			PF 2	WSM 20	WSM 20	WSM 20
K	K1-K7	medium	PM 5	WAK 10	WAK 20	WAK 30
			E 47	WPP 20	WPP 20	WPP 20
		high	PS 5	WAK 10	WAK 20	WAK 20
			PF 5	WPP 20	WPP 20	WPP 20
N	N1-N10	high	PM 2	WK 1 / WXN 10	WK 1 / WXN 10	WK 1 / WXN 10
			PF 2	WK 1 / WXN 10	WK 1 / WXN 10	WK 1 / WXN 10
S	S1-S10	medium	E 47	WSM 20	WSM 20	—
			PM 5	WSM 20	WSM 20	WSM 30
			PS 5	WSM 20	WSM 20	WSM 30
			PF 4	WSM 20	WSM 20	WSM 30
		high	PF 5	WSM 30	WSM 30	WSM 30
			PF 2	WSM 20	WSM 20	—
O	O1-O6	high	PM 2	WK 1 / WXN 10	WK 1 / WXN 10	WK 1 / WXN 10
			PF 2	WK 1 / WXN 10	WK 1 / WXN 10	WK 1 / WXN 10

STEP 5

Select the **cutting data** from page C-82 onwards.

Cutting data for boring												
Material group	Structure of main material groups and code letters	Anneal hardness HB	Tensile strength R_m [N/mm ²]	Machining group ¹⁾	Insert geometry							
					Starting values for feed f [mm/U]							
					-E47			-PM5				
					D_c [mm]	D_c [mm]	D_c [mm]	D_c [mm]	D_c [mm]	D_c [mm]		
P	Non-alloyed steel	C ≤ 0.25%	annealed	125 428	P1	●●	0.20	0.30	0.40	2.20	0.30	0.40
		C > 0.25 - ≤ 0.55%	annealed	190 639	P2	●●	0.16	0.24	0.40	0.16	0.24	0.40
		C > 0.25 - ≤ 0.55%	tempered	210 708	P3	●●	0.15	0.22	0.35	0.15	0.22	0.35
		C > 0.55%	annealed	190 639	P4	●●	0.14	0.20	0.30	0.14	0.20	0.30
		C > 0.55%	tempered	300 1013	P5	●●	0.12	0.18	0.25	0.12	0.18	0.25
		machining steel (short-chipping)	annealed	220 745	P6	●●	●	0.15	0.22	0.35	0.15	0.22
	Low-alloyed steel	annealed	175 591	P7	●●	0.20	0.30	0.40	0.20	0.30	0.40	
		tempered	300 1013	P8	●●	0.14	0.20	0.30	0.14	0.20	0.30	
		tempered	380 1282	P9	●●	0.12	0.18	0.25	0.12	0.18	0.25	
		tempered	430 1477	P10	●●	0.10	0.15	0.20	0.10	0.15	0.20	
	High-alloyed steel and high-alloyed tool steel	annealed	200 675	P11	●●	0.14	0.20	0.30	0.14	0.20	0.30	
		hardened and tempered	300 1013	P12	●●	0.13	0.18	0.27	0.13	0.18	0.27	
Stainless steel	hardened and tempered	400 1361	P13	●●	0.10	0.15	0.20	0.10	0.15	0.20		
	ferritic/martensitic, annealed	200 675	P14	●●	0.12	0.16	0.24	0.12	0.16	0.24		
M	austenitic, tempered	330 1116	P15	●●	0.12	0.16	0.24	0.12	0.16	0.24		
		330 1116	P15	●●	0.12	0.16	0.24	0.12	0.16	0.24		

Positive basic shape CCGT/CCMT

Tiger-tec®

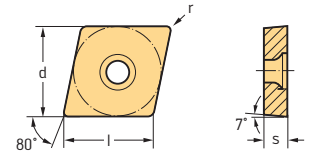

Indexable inserts

Designation	d mm	l mm	s mm	r mm	P				M			K			N		S		
					HC				HC			HC			HC	HW	HC		
					WPP01	WPP10	WPP20	WPP30	WSM10	WSM20	WSM30	WAK10	WAK20	WAK30	WXN10	WK1	WSM10	WSM20	WSM30
	CCMT060202-E47	6,35	6,45	2,38	0,2		☒			☒	☒						☒	☒	
	CCMT060204-E47	6,35	6,45	2,38	0,4		☒			☒	☒						☒	☒	
	CCMT09T302-E47	9,525	9,67	3,97	0,2		☒			☒	☒						☒	☒	
	CCMT09T304-E47	9,525	9,67	3,97	0,4		☒			☒	☒						☒	☒	
	CCMT09T308-E47	9,525	9,67	3,97	0,8		☒			☒	☒						☒	☒	
	CCMT120404-E47	12,7	12,9	4,76	0,4		☒			☒	☒						☒	☒	
	CCMT120408-E47	12,7	12,9	4,76	0,8		☒			☒	☒						☒	☒	
	CCMT120412-E47	12,7	12,9	4,76	1,2		☒			☒	☒						☒	☒	
	CCGT060201-PF2	6,35	6,45	2,38	0,1					☒				☒	☒		☒		
	CCGT060202-PF2	6,35	6,45	2,38	0,2					☒				☒	☒		☒		
	CCGT060204-PF2	6,35	6,45	2,38	0,4					☒				☒	☒		☒		
	CCGT09T301-PF2	9,525	9,67	3,97	0,1					☒				☒	☒		☒		
	CCGT09T302-PF2	9,525	9,67	3,97	0,2					☒				☒	☒		☒		
	CCGT09T304-PF2	9,525	9,67	3,97	0,4					☒				☒	☒	☒	☒		
	CCGT09T308-PF2	9,525	9,67	3,97	0,8					☒				☒	☒	☒	☒		
	CCGT120404-PF2	12,7	12,9	4,76	0,4					☒				☒	☒	☒	☒		
CCGT120408-PF2	12,7	12,9	4,76	0,8					☒				☒	☒	☒	☒			
	CCMT060202-PF4	6,35	6,45	2,38	0,2	☒	☒	☒		☒	☒						☒	☒	
	CCMT060204-PF4	6,35	6,45	2,38	0,4	☒	☒	☒		☒	☒						☒	☒	
	CCMT060208-PF4	6,35	6,45	2,38	0,8	☒	☒	☒		☒	☒						☒	☒	
	CCMT09T302-PF4	9,525	9,67	3,97	0,2	☒	☒	☒		☒	☒						☒	☒	
	CCMT09T304-PF4	9,525	9,67	3,97	0,4	☒	☒	☒		☒	☒						☒	☒	
	CCMT09T308-PF4	9,525	9,67	3,97	0,8	☒	☒	☒		☒	☒						☒	☒	
	CCMT120404-PF4	12,7	12,9	4,76	0,4	☒	☒	☒		☒	☒						☒	☒	
	CCMT120408-PF4	12,7	12,9	4,76	0,8	☒	☒	☒		☒	☒						☒	☒	
	CCGT060202-PF5	6,35	6,45	2,38	0,2			☒	☒									☒	
	CCGT060204-PF5	6,35	6,45	2,38	0,4			☒	☒									☒	
	CCGT09T302-PF5	9,525	9,67	3,97	0,2			☒	☒									☒	
	CCGT09T304-PF5	9,525	9,67	3,97	0,4			☒	☒									☒	
	CCMT060204-PS5	6,35	6,45	2,38	0,4		☒			☒	☒						☒	☒	
	CCMT060208-PS5	6,35	6,45	2,38	0,8		☒			☒	☒						☒	☒	
	CCMT09T304-PS5	9,525	9,67	3,97	0,4		☒			☒	☒						☒	☒	
	CCMT09T308-PS5	9,525	9,67	3,97	0,8		☒			☒	☒						☒	☒	
	CCMT120404-PS5	12,7	12,9	4,76	0,4		☒			☒	☒						☒	☒	
	CCMT120408-PS5	12,7	12,9	4,76	0,8		☒			☒	☒						☒	☒	

HC = Coated carbide
HW = Uncoated carbide

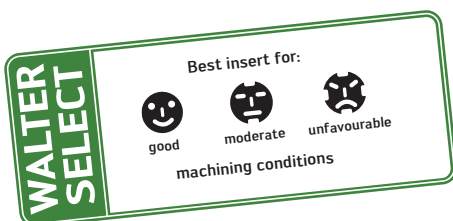

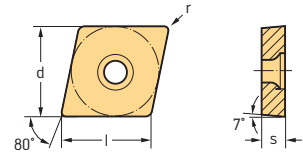

☒ ☒ ☒ New addition to range

Positive basic shape CCGT/CCMT

Tiger-tec®

Indexable inserts

Designation	d mm	l mm	s mm	r mm	P				M			K		N		S		
					HC				HC			HC		HC	HW	HC		
					WPP01	WPP10	WPP20	WPP30	WSM10	WSM20	WSM30	WAK10	WAK20	WAK30	WXN10	WK1	WSM10	WSM20
 CCGT060201-PM2	6,35	6,45	2,38	0,1										☺	☺			
CCGT060202-PM2	6,35	6,45	2,38	0,2										☺	☺			
CCGT060204-PM2	6,35	6,45	2,38	0,4										☺	☺			
CCGT09T301-PM2	9,525	9,67	3,97	0,1										☺	☺			
CCGT09T302-PM2	9,525	9,67	3,97	0,2										☺	☺			
CCGT09T304-PM2	9,525	9,67	3,97	0,4										☺	☺			
CCGT09T308-PM2	9,525	9,67	3,97	0,8										☺	☺			
CCGT120402-PM2	12,7	12,9	4,76	0,2										☺	☺			
CCGT120404-PM2	12,7	12,9	4,76	0,4										☺	☺			
CCGT120408-PM2	12,7	12,9	4,76	0,8										☺	☺			
 CCMT060204-PM5	6,35	6,45	2,38	0,4	☺	☺	☺	☺	☺	☺	☺	☺	☺			☺	☺	☺
CCMT060208-PM5	6,35	6,45	2,38	0,8	☺	☺	☺	☺	☺	☺	☺	☺	☺			☺	☺	☺
CCMT09T304-PM5	9,525	9,67	3,97	0,4	☺	☺	☺	☺	☺	☺	☺	☺	☺			☺	☺	☺
CCMT09T308-PM5	9,525	9,67	3,97	0,8	☺	☺	☺	☺	☺	☺	☺	☺	☺			☺	☺	☺
CCMT120404-PM5	12,7	12,9	4,76	0,4	☺	☺	☺	☺	☺	☺	☺	☺	☺			☺	☺	☺
CCMT120408-PM5	12,7	12,9	4,76	0,8	☺	☺	☺	☺	☺	☺	☺	☺	☺			☺	☺	☺
CCMT120412-PM5	12,7	12,9	4,76	1,2	☺	☺	☺	☺	☺	☺	☺	☺	☺			☺	☺	☺

 HC = Coated carbide
 HW = Uncoated carbide

Positive basic shape SCMT

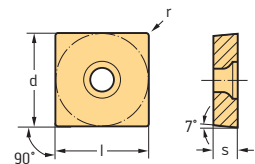
Tiger-tec®

Indexable inserts

Designation	d mm	l mm	s mm	r mm	P				M			K		N		S		
					HC				HC			HC		HC	HW	HC		
					WPP01	WPP10	WPP20	WPP30	WSM10	WSM20	WSM30	WAK10	WAK20	WXN10	WK1	WSM10	WSM20	WSM30
 SCMT060204-E47	6,35	6,35	2,38	0,4			☺	☺	☺	☺	☺					☺	☺	☺
SCMT09T304-E47	9,525	9,525	3,97	0,4			☺	☺	☺	☺	☺					☺	☺	☺
SCMT09T308-E47	9,525	9,525	3,97	0,8			☺	☺	☺	☺	☺					☺	☺	☺
SCMT120408-E47	12,7	12,7	4,76	0,8			☺	☺	☺	☺	☺					☺	☺	☺

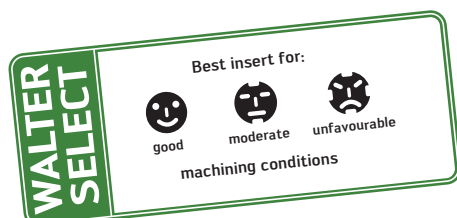
 HC = Coated carbide
 HW = Uncoated carbide

New addition to range

**Positive basic shape
WCGT/WCMT**

Tiger-tec®

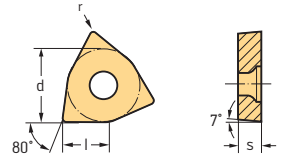

Indexable inserts

	Designation	d mm	l mm	s mm	r mm	P				M			K		N		S				
						HC				HC			HC	HC	HW	HC					
						WPP01	WPP10	WPP20	WPP30	WSM10	WSM20	WSM21	WSM30	WAK10	WAK20	WXN10	WK1	WSM10	WSM20	WSM30	
	WCMT030204-E47	5,56	3,5	2,38	0,4			☒			☒	☒	☒							☒	☒
	WCMT040204-E47	6,35	4,3	2,38	0,4			☒			☒	☒	☒							☒	☒
	WCMT06T304-E47	9,525	6,5	3,97	0,4			☒			☒	☒	☒							☒	☒
	WCMT06T308-E47	9,525	6,5	3,97	0,8			☒			☒	☒	☒							☒	☒
	WCMT080408-E47	12,7	8,7	4,76	0,8			☒			☒	☒	☒							☒	☒
	WCGT030201-PF2	5,56	3,8	2,38	0,1											☒	☒				
	WCGT030202-PF2	5,56	3,8	2,38	0,2						☒					☒	☒				
	WCGT030204-PF2	5,56	3,8	2,38	0,4						☒					☒	☒				
	WCGT040201-PF2	6,35	4,3	2,38	0,1											☒	☒				
	WCGT040202-PF2	6,35	4,3	2,38	0,2						☒					☒	☒				
	WCGT040204-PF2	6,35	4,3	2,38	0,4						☒					☒	☒				
	WCGT06T301-PF2	9,525	6,5	3,97	0,1											☒	☒				
	WCGT06T302-PF2	9,525	6,5	3,97	0,2											☒	☒				
	WCGT06T304-PF2	9,525	6,5	3,97	0,4											☒	☒				
WCGT06T308-PF2	9,525	6,5	3,97	0,8											☒	☒					
	WCMT040202-PF4	6,35	4,3	2,38	0,2		☒	☒			☒	☒								☒	☒
	WCMT040204-PF4	6,35	4,3	2,38	0,4		☒	☒			☒	☒								☒	☒
	WCMT040208-PF4	6,35	4,3	2,38	0,8		☒	☒			☒	☒								☒	☒
	WCMT06T302-PF4	9,525	6,5	3,97	0,2		☒	☒			☒	☒								☒	☒
	WCMT06T304-PF4	9,525	6,5	3,97	0,4		☒	☒			☒	☒								☒	☒
	WCMT06T308-PF4	9,525	6,5	3,97	0,8		☒	☒			☒	☒								☒	☒
	WCMT080404-PF4	12,7	8,7	4,76	0,4		☒	☒			☒	☒								☒	☒
	WCMT080408-PF4	12,7	8,7	4,76	0,8		☒	☒			☒	☒								☒	☒
	WCMT040204-PS5	6,35	4,3	2,38	0,4			☒						☒	☒						
	WCMT040208-PS5	6,35	4,3	2,38	0,8			☒						☒	☒						
	WCMT06T304-PS5	9,525	6,5	3,97	0,4			☒						☒	☒						
	WCMT06T308-PS5	9,525	6,5	3,97	0,8			☒						☒	☒						
	WCMT080404-PS5	12,7	8,7	4,76	0,4			☒						☒	☒						
	WCMT080408-PS5	12,7	8,7	4,76	0,8			☒						☒	☒						
	WCGT030202-PM2	5,56	3,8	2,38	0,2											☒	☒				
	WCGT030204-PM2	5,56	3,8	2,38	0,4											☒	☒				
	WCGT040202-PM2	6,35	4,3	2,38	0,2											☒	☒				
	WCGT040204-PM2	6,35	4,3	2,38	0,4											☒	☒				
	WCGT06T302-PM2	9,525	6,5	3,97	0,2											☒	☒				
	WCGT06T304-PM2	9,525	6,5	3,97	0,4											☒	☒				
	WCGT080404-PM2	12,7	8,7	4,76	0,4											☒	☒				
	WCGT080408-PM2	12,7	8,7	4,76	0,8											☒	☒				
	WCMT030202-PM5	5,56	3,8	2,38	0,2		☒	☒	☒		☒	☒								☒	☒
	WCMT040202-PM5	6,35	4,3	2,38	0,2		☒	☒	☒		☒	☒								☒	☒
	WCMT040204-PM5	6,35	4,3	2,38	0,4		☒	☒	☒		☒	☒								☒	☒
	WCMT06T304-PM5	9,525	6,5	3,97	0,4		☒	☒	☒		☒	☒								☒	☒
	WCMT06T308-PM5	9,525	6,5	3,97	0,8		☒	☒	☒		☒	☒								☒	☒
	WCMT080404-PM5	12,7	8,7	4,76	0,4		☒	☒	☒		☒	☒								☒	☒
	WCMT080408-PM5	12,7	8,7	4,76	0,8		☒	☒	☒		☒	☒								☒	☒
	WCMT080412-PM5	12,7	8,7	4,76	1,2		☒	☒	☒		☒	☒								☒	☒

HC = Coated carbide
HW = Uncoated carbide

☒ ☒ ☒ New addition to range

Walter Select for indexable inserts for precision boring

Step by step to the right indexable insert

STEP 1



Determine the **material** to be machined from page H 8 in the Walter General catalogue 2012.

Note the machining group that corresponds to your material e.g.: P10.

Code letter	Machining group	Groups of the materials to be machined	
P	P1–P15	Steel	All types of steel and cast steel, with the exception of steel with an austenitic structure
M	M1–M3	Stainless steel	Stainless austenitic steel, austenitic-ferritic steel and cast steel
K	K1–K7	Cast iron	Grey cast iron, cast iron with spheroidal graphite, malleable cast iron, cast iron with vermicular graphite
N	N1–N10	NF metals	Aluminium and other non-ferrous metals, non-ferrous materials
S	S1–S10	High temperature alloys and titanium alloys	Heat resisting special alloys based on iron, nickel and cobalt, titanium and titanium alloys
H	H1–H4	Hard materials	Hardened steel, hardened cast iron materials, chilled cast iron
O	O1–O6	Other	Plastics, glass- and carbon fibre reinforced plastics, graphite

STEP 2

Select the **machining conditions**:

Type of cutting action	Machining conditions
Smooth cut level entry or exit surfaces	
Laminate bores Cast and forged inclines < 5°	
Bores with interrupted cuts Cast and forged inclines > 5°	

STEP 3

Determine the **indexable insert geometry** via the material and the projection length.

Code letter	Machining group	Projection length		
		< 3 x D _c	< 5 x D _c	< 6 x D _c
P	P1–P15	PF 2 / PF 5 / PF 4	X 5 / X 15	—
M	M1–M3	PF 4 / PF 5	X 5 / X 15	—
K	K1–K7	PF 4 / CCMW / WCMW	X 5 / CCMW / WCMW	X 15
N	N1–N6	PM 2 / PF 2 / WCMW	X 25 / PF 2 / WCMW	X 25 / PF 2
	N7–N10	PM 2 / PF 2	X 15 / X 25	X 25
S	S1–S10	PM 2 / PF 2 / PF 5	X 5 / X 15	—
H	H1–H4	CCMW / WCMW	CCMW / WCMW	—
O	O1–O6	PM 2 / PF 2 / WCMW	X 25 / WCMW	—

STEP 4

Determine the **cutting tool material** by means of the indexable insert geometry and the machining conditions:

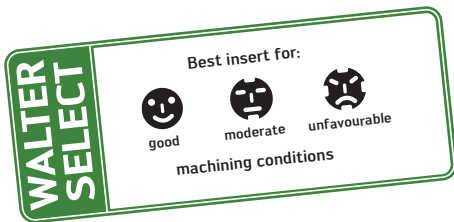

Code letter	Machining group	Walter Indexable insert geometry	Machining conditions		
P	P1–P15	X 5 / X15	WAK 15	WXM 15	WTP 35
		PF 2	WSM 20	WSM 20	WSM 20
		PF 5	WPP 20	WPP 20	WPP 20
		PF 4*	WPP 10	WPP 20	WPP 20
M	M1–M3	X 5 / X15	WTP 35 / WXM 15	WTP 35 / WXM 15	WTP 35 / WXM 15
		PF 2	WSM 20	WSM 20	—
		PF 5	—	WSM 30	WSM 30
K	K1–K7	X 5 / X15	WAK 15	WXM 15	WTP 35
		CCMW / WCMW	WCB 80	WCB 50	—
		PF 4*	WPP 10	WPP 20	WPP 20
N	N1–N6	X 25	WK 1	WK 1	WK 1
		PM 2	WK 1 / WXN 10	WK 1 / WXN 10	WK 1 / WXN 10
		PF 2	WK 1 / WXN 10	WK 1 / WXN 10	WK 1 / WXN 10
		WCMW	WCD 10	WCD 10	—
	N7–N10	X 17 / X 25	WK 1	WK 1	WK 1
		PF 2	WK 1 / WXN 10	WK 1 / WXN 10	WK 1 / WXN 10
S	S1–S10	X5 / X 15	WK 1	WK 1	WK 1
		PM 2	WXN 10	—	—
		PF 2	WSM 20	WSM 20	—
		PF 5	WSM 30	WSM 30	WSM 30
H	H1–H4	CCMW	WCB 30	WCB 50	WCB 50
		WCMW	WCB 50	WCB 50	WCB 50
O	O1–O6	X 25	WK 1	WK 1	WK 1
		PM 2	WK 1	WK 1	WK 1
		PF 2	WK 1	WK 1	WK 1
		WCMW	WCD 10	WCD 10	—

*Insert fully sintered

Walter Select for indexable inserts for precision boring

Step by step to the right indexable insert

STEP 5

Now select the **corner radius r** and the **cutting depth a_p** by means of the adjacent graphs.

Choose the maximum possible corner radius with reference to the relevant length-to-diameter ratio (L/D). The optimal cutting depths a_p are around 2/3 of the specified maximum a_p values.

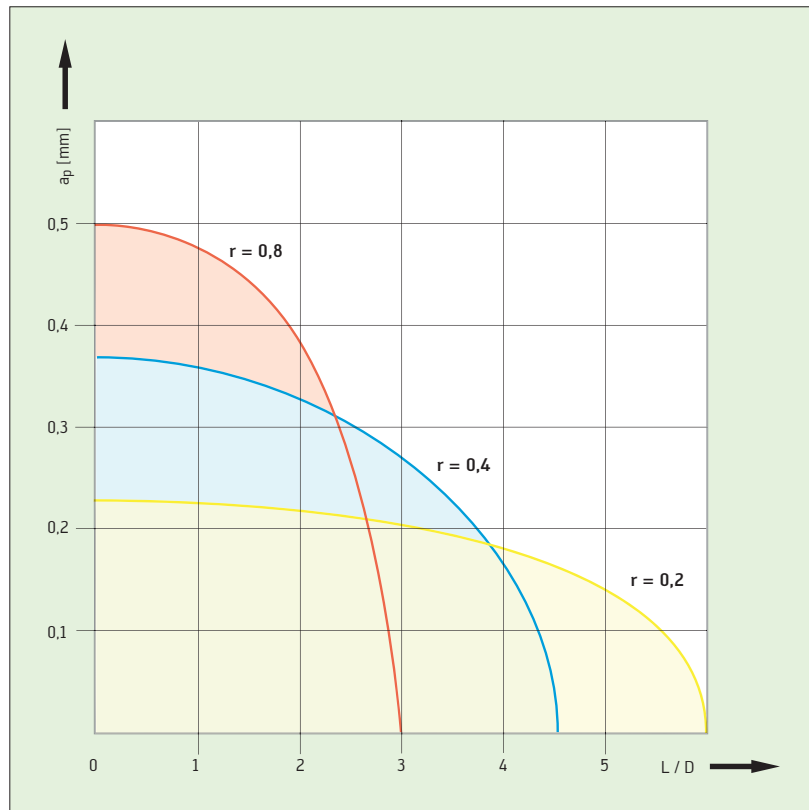

STEP 6

Now select the maximum feed rate depending on the specified surface quality of the workpiece and the corner radius of the insert selected in step 5.

Corner radius Indexable insert r [mm]	Roughness [μm]									
	max. feed rate f [mm/rev]									
	0,03		0,06		0,09		0,12		0,15	
	R_{max}	R_a	R_{max}	R_a	R_{max}	R_a	R_{max}	R_a	R_{max}	R_a
0,2	0,56	0,14	2,26	0,58	5,13	1,32	9,21	3,38	14,60	3,79
0,4	0,28	0,07	1,13	0,29	2,54	0,65	4,53	1,16	7,09	1,83

STEP 7



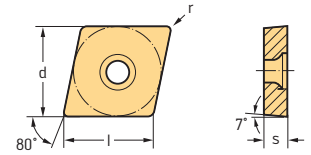

Select the **cutting data** from page C-86 onwards.

Cutting data for precision boring										
Material group	Structure of main material groups and code letters	Anneal hardness HB	Tensile strength R_m N/mm ²	Machining group 1	Starting values for cutting speed v_c [m/min]					
					HC					
					WPP01 / WPP10					
						L/D				
						3 x D _c	4 x D _c	6 x D _c		
Non-alloyed steel	C > 0.25%	annealed	125 428	P1	●●	355	320	195		
	C > 0.25% < 0.55%	annealed	190 639	P2	●●	335	295	160		
	C > 0.25% < 0.55%	tempered	210 708	P3	●●	300	240	150		
	C > 0.55%	annealed	190 639	P4	●●	290	230	140		
	C > 0.55%	tempered	300 1013	P5	●●	255	205	125		
	machining steel (short-chipping)	annealed	220 745	P6	●●	300	240	150		
Low-alloyed steel	annealed	175 591	P7	●●	330	285	160			
	tempered	300 1013	P8	●●	275	220	140			
	tempered	380 1282	P9	●●	245	195	115			
	tempered	430 1477	P10	●●	200	160	80			
High-alloyed steel and high-alloyed tool steel	annealed	200 675	P11	●●	275	220	140			
	hardened and tempered	300 1013	P12	●●	230	195	115			
	hardened and tempered	400 1361	P13	●●	210	170	90			
Stainless steel	ferritic/martensitic, annealed	200 675	P14	●●	275	205	140			
	martensitic, tempered	330 1114	P15	●●	210	180	100			
	austenitic, quench hardened	200 675	M1	●●						
Stainless steel	austenitic, precipitation hardened (PH)	300 1013	M2	●●						
	austenitic/ferritic, duplex	230 778	M3	●●						
	ferritic	200 675	K1	●●	280	235	130			
Malleable cast iron	ferritic	260 867	K2	●●	220	185	115			
	pearlitic	180 602	K3	●●	300	255	150			
	low tensile strength	245 825	K4	●●	220	185	115			
	high tensile strength/austenitic	155 518	K5	●●	275	220	140			
Cast iron with spheroidal graphite	ferritic	155 518	K5	●●	275	220	140			
	pearlitic	300 1013	K6	●●	220	185	115			

Positive basic shape CCGT/CCMT/CCMW

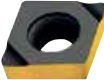

Indexable inserts

Designation	d mm	l mm	s mm	r mm	P					M			K		N		S		H					
					HC					HC			HC		HC HW		HC		B	L	BH	HC		
					WPP01	WPP10	WPP20	WPP30	WTP35	WSM10	WSM20	WSM30	WAK10	WAK15	WAK20	WXN10	WK1	WSM10	WSM20	WSM30	WCB30	WCB50	WXM15	
 CCGT060202-X5	6,35	6,45	2,38	0,2										☉										
CCGT060204-X5	6,35	6,45	2,38	0,4										☉										
 CCGT060202-X15	6,35	6,45	2,38	0,2										☉										
CCGT060204-X15	6,35	6,45	2,38	0,4										☉										
 CCGT060201-PF2	6,35	6,45	2,38	0,1																				
CCGT060202-PF2	6,35	6,45	2,38	0,2																				
CCGT060204-PF2	6,35	6,45	2,38	0,4																				
CCGT09T301-PF2	9,525	9,67	3,97	0,1																				
CCGT09T302-PF2	9,525	9,67	3,97	0,2																				
CCGT09T304-PF2	9,525	9,67	3,97	0,4																				
CCGT09T308-PF2	9,525	9,67	3,97	0,8																				
CCGT120404-PF2	12,7	12,9	4,76	0,4																				
CCGT120408-PF2	12,7	12,9	4,76	0,8																				
 CCGT060202-PF5	6,35	6,45	2,38	0,2			☹	☹																
CCGT060204-PF5	6,35	6,45	2,38	0,4			☹	☹																
CCGT09T302-PF5	9,525	9,67	3,97	0,2			☹	☹																
CCGT09T304-PF5	9,525	9,67	3,97	0,4			☹	☹																
 CCMT060202-PF4	6,35	6,45	2,38	0,2	☹	☹	☹																	
CCMT060204-PF4	6,35	6,45	2,38	0,4	☹	☹	☹																	
CCMT060208-PF4	6,35	6,45	2,38	0,8	☹	☹	☹																	
CCMT09T302-PF4	9,525	9,67	3,97	0,2	☹	☹	☹																	
CCMT09T304-PF4	9,525	9,67	3,97	0,4	☹	☹	☹																	
CCMT09T308-PF4	9,525	9,67	3,97	0,8	☹	☹	☹																	
CCMT120404-PF4	12,7	12,9	4,76	0,4	☹	☹	☹																	
CCMT120408-PF4	12,7	12,9	4,76	0,8	☹	☹	☹																	
 CCGT060201-PM2	6,35	6,45	2,38	0,1																				
CCGT060202-PM2	6,35	6,45	2,38	0,2																				
CCGT060204-PM2	6,35	6,45	2,38	0,4																				
CCGT09T301-PM2	9,525	9,67	3,97	0,1																				
CCGT09T302-PM2	9,525	9,67	3,97	0,2																				
CCGT09T304-PM2	9,525	9,67	3,97	0,4																				
CCGT09T308-PM2	9,525	9,67	3,97	0,8																				
CCGT120402-PM2	12,7	12,9	4,76	0,2																				
CCGT120404-PM2	12,7	12,9	4,76	0,4																				
CCGT120408-PM2	12,7	12,9	4,76	0,8																				

HC = Coated carbide
 HW = Uncoated carbide
 BL = CBN with low CBN content
 BH = CBN with high CBN content

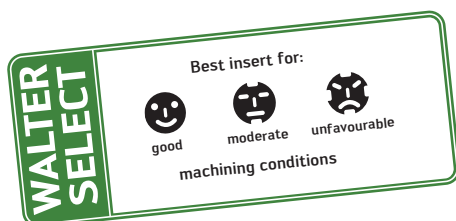

☹ ☹ ☹ New addition to range

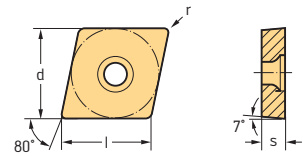
Positive basic shape
 CCGT/CCMT/CCMW

Indexable inserts

	Designation	d mm	l mm	s mm	r mm	P					M			K			N		S			H			
						HC					HC			HC			HC	HW	HC			BL	BH	HC	
						WPP01	WPP10	WPP20	WPP30	WTP35	WSM10	WSM20	WSM30	WAK10	WAK15	WAK20	WXN10	WK1	WSM10	WSM20	WSM30	WCB30	WCB50	WXM15	
	CCMT060204-PF	6,35	6,45	2,38	0,4	☉	☉	☉				☉	☉								☉	☉	☉		
	CCMT060208-PF	6,35	6,45	2,38	0,8	☉	☉	☉				☉	☉								☉	☉	☉		
	CCMT09T304-PF	9,525	9,67	3,97	0,4	☉	☉	☉				☉	☉								☉	☉	☉		
	CCMT09T308-PF	9,525	9,67	3,97	0,8	☉	☉	☉				☉	☉								☉	☉	☉		
	CCMW060204	6,35	6,45	2,38	0,4																		☉	☉	
	CCMW060208	6,35	6,45	2,38	0,8																		☉	☉	
	CCMW09T304	9,525	9,67	3,97	0,4																		☉	☉	
	CCMW09T308	9,525	9,67	3,97	0,8																		☉	☉	
	CCMW060204-2	6,35	6,45	2,38	0,4																		☉	☉	
	CCMW060208-2	6,35	6,45	2,38	0,8																		☉	☉	
	CCMW09T304-2	9,525	9,67	3,97	0,4																		☉	☉	
	CCMW09T308-2	9,525	9,67	3,97	0,8																		☉	☉	

HC = Coated carbide
 HW = Uncoated carbide
 BL = CBN with low CBN content
 BH = CBN with high CBN content

 Positive basic shape
 CPGT

Tiger-tec®

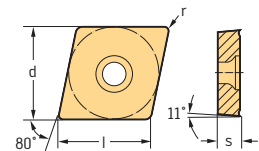

Indexable inserts

	Designation	d mm	l mm	s mm	r mm	P					M			K			N		S			HC		
						HC					HC			HC			HC	HW	HC					
						WPP01	WPP10	WPP20	WPP30	WTP35	WSM10	WSM20	WSM30	WAK10	WAK15	WAK20	WXN10	WK1	WSM10	WSM20	WSM30	WXM15		
	CPGT050202-PF5	5,56	5,65	2,38	0,2									☉										
	CPGT050202-X5	5,56	5,65	2,38	0,2																			
	CPGT050204-X5	5,56	5,65	2,38	0,4																			
	CPGT050202-X15	5,56	5,65	2,38	0,2																			
	CPGT050204-X15	5,56	5,65	2,38	0,4																			



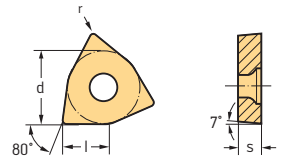

HC = Coated carbide
 HW = Uncoated carbide

Positive basic shape WCMT/WCGT/WCMW

Tiger-tec®



Indexable inserts

Designation	d mm	l mm	s mm	r mm	P					M			K		N		S			H		
					HC					HC			HC		HC HW		HC			BH		
					WPP01	WPP10	WPP20	WPP30	WTP35	WSM10	WSM20	WSM21	WSM30	WAK10	WAK15	WAK20	WXN10	WK1	WSM10	WSM20	WSM30	WCB50
 WCGT020102-X5	3,97	2,7	1,59	0,2																		
WCGT020104-X5	3,97	2,7	1,59	0,4																		
WCGT030202-X5	5,56	3,8	2,38	0,2																		
WCGT030204-X5	5,56	3,8	2,38	0,4																		
WCGT040202-X5	6,35	4,3	2,38	0,2																		
WCGT040204-X5	6,35	4,3	2,38	0,4																		
WCGT050304-X5	7,94	5,43	3,18	0,4																		
 WCGT020102-X15	3,97	2,7	1,59	0,2																		
WCGT020104-X15	3,97	2,7	1,59	0,4																		
WCGT030202-X15	5,56	3,8	2,38	0,2																		
WCGT030204-X15	5,56	3,8	2,38	0,4																		
WCGT040202-X15	6,35	4,3	2,38	0,2																		
WCGT040204-X15	6,35	4,3	2,38	0,4																		
WCGT050304-X15	7,94	5,43	3,18	0,4																		
 WCGT020102-X25	3,97	2,7	1,59	0,2																		
WCGT030202-X25	5,56	3,8	2,38	0,2																		
WCGT030204-X25	5,56	3,8	2,38	0,4																		
WCGT040204-X25	6,35	4,3	2,38	0,4																		
WCGT050304-X25	7,94	5,43	3,18	0,4																		
 WCGT030201-PF2	5,56	3,8	2,38	0,1																		
WCGT030202-PF2	5,56	3,8	2,38	0,2																		
WCGT030204-PF2	5,56	3,8	2,38	0,4																		
WCGT040201-PF2	6,35	4,3	2,38	0,1																		
WCGT040202-PF2	6,35	4,3	2,38	0,2																		
WCGT040204-PF2	6,35	4,3	2,38	0,4																		
WCGT06T301-PF2	9,525	6,5	3,97	0,1																		
WCGT06T302-PF2	9,525	6,5	3,97	0,2																		
WCGT06T304-PF2	9,525	6,5	3,97	0,4																		
WCGT06T308-PF2	9,525	6,5	3,97	0,8																		

HC = Coated carbide
 HW = Uncoated carbide
 BH = CBN with high CBN content

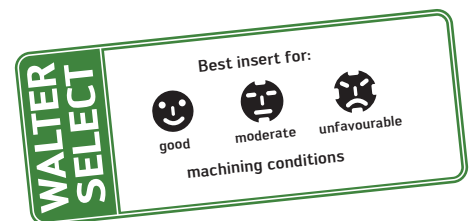

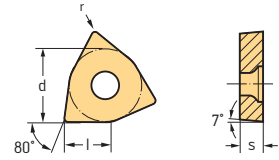

Positive basic shape
 WCMT/WCGT/WCMW

Tiger-tec®



Indexable inserts

Designation	d mm	l mm	s mm	r mm	P					M			K		N		S		H	
					HC					HC			HC		HC		HC		BH	
					WPP01	WPP10	WPP20	WPP30	WTP35	WSM10	WSM20	WSM21	WSM30	WAK10	WAK15	WAK20	WXN10	WK1	WSM10	WSM20
 WCMT040202-PF4	6,35	4,3	2,38	0,2	☺	☺	☺				☺	☺					☺	☺		
WCMT040204-PF4	6,35	4,3	2,38	0,4	☺	☺	☺				☺	☺					☺	☺		
WCMT040208-PF4	6,35	4,3	2,38	0,8	☺	☺	☺				☺	☺					☺	☺		
WCMT06T302-PF4	9,525	6,5	3,97	0,2	☺	☺	☺				☺	☺					☺	☺		
WCMT06T304-PF4	9,525	6,5	3,97	0,4	☺	☺	☺				☺	☺					☺	☺		
WCMT06T308-PF4	9,525	6,5	3,97	0,8	☺	☺	☺				☺	☺					☺	☺		
WCMT080404-PF4	12,7	8,7	4,76	0,4	☺	☺	☺				☺	☺					☺	☺		
WCMT080408-PF4	12,7	8,7	4,76	0,8	☺	☺	☺				☺	☺					☺	☺		
 WCGT030202-PM2	5,56	3,8	2,38	0,2											☺	☺				
WCGT030204-PM2	5,56	3,8	2,38	0,4											☺	☺				
WCGT040202-PM2	6,35	4,3	2,38	0,2											☺	☺				
WCGT040204-PM2	6,35	4,3	2,38	0,4											☺	☺				
WCGT06T302-PM2	9,525	6,5	3,97	0,2											☺	☺				
WCGT06T304-PM2	9,525	6,5	3,97	0,4											☺	☺				
WCGT080404-PM2	12,7	8,7	4,76	0,4											☺	☺				
WCGT080408-PM2	12,7	8,7	4,76	0,8											☺	☺				
 WCMW020102	3,97	2,7	1,59	0,2																☺
WCMW020104	3,97	2,7	1,59	0,4																☺
WCMW030202	5,56	3,8	2,38	0,2																☺
WCMW030204	5,56	3,8	2,38	0,4																☺
WCMW040202	6,35	4,3	2,38	0,2																☺
WCMW040204	6,35	4,3	2,38	0,4																☺
WCMW050304	7,94	5,43	3,18	0,4																☺

HC = Coated carbide

HW = Uncoated carbide

BH = CBN with high CBN content

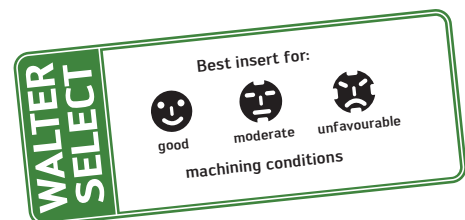



Product range overview of drilling and boring tools with indexable inserts

Drilling

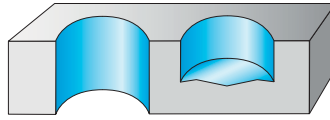

For Walter Select, see page C-34

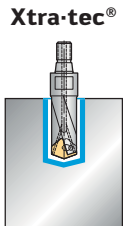
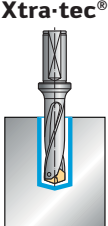
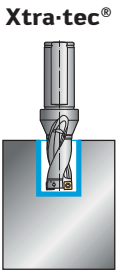
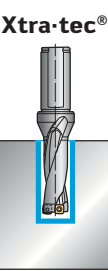
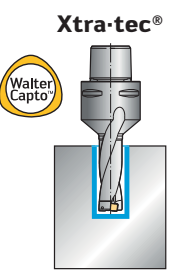
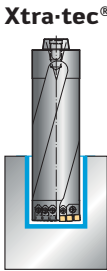
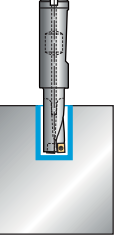
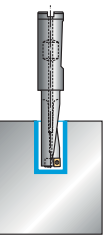
$L_c = 1,3 \times D_c$	$L_c = 2 \times D_c$	$L_c = 3 \times D_c$		
B 4011 <i>Page C 50*</i> Dc = 12–25,99 mm 		B 4013 <i>Page C 62*</i> Dc = 12–37,99 mm 		
	B 4212 <i>Page C 52*</i> Dc = 13,5–59 mm 	B 4213 <i>Page C 64*</i> Dc = 13,5–59 mm 	B 4213.C Page C-38 Dc = 16–45 mm 	B 4213.N <i>Page C 68*</i> Dc = 65–80 mm 
B 3212 <i>Page C 56*</i> Dc = 10–18 mm 	B 3213 <i>Page C 70*</i> Dc = 10–18 mm 			

* The pages indicated in italics refer to the Walter General catalogue 2012.

Drilling

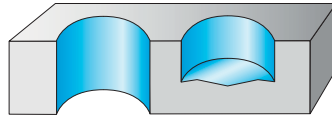

For Walter Select, see page C-34

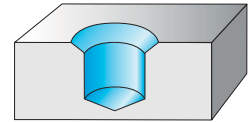









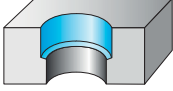
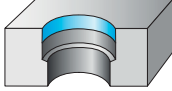
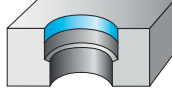
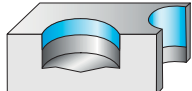
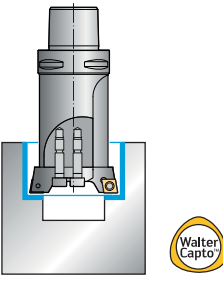

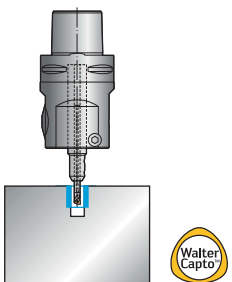

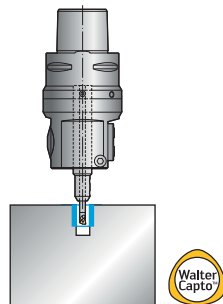

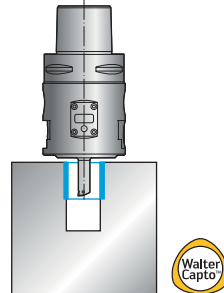

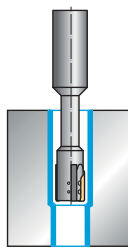
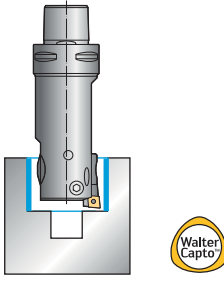

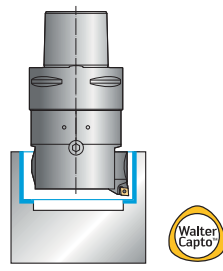

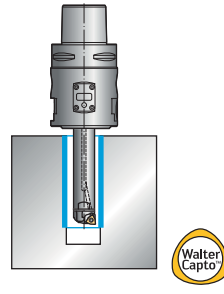
For Walter Select see page C-34

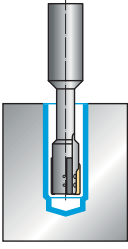
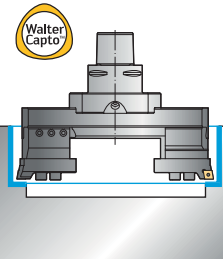
	$L_c = 4 \times D_c$	$L_c = 5 \times D_c$	$L_c = 7 \times D_c$	$L_c = 10 \times D_c$	$L_c = 2 \times D_c$
		B 4015 Page C 80* $D_c = 12-37,99$ mm 	B 4017 Page C-40 $D_c = 12-37,99$ mm 	B 4010 Page C 88* $D_c = 18-24,99$ mm 	B 4012C Page C 60* $D_c = 12-29,99$ mm
	B 4214 Page C 74* $D_c = 17-59$ mm 	B 4215 Page C 82* $D_c = 17-59$ mm 			
	B 3214 Page C 78* $D_c = 10-18$ mm 				

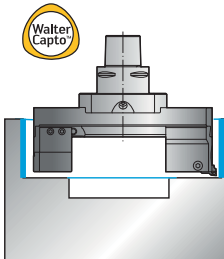

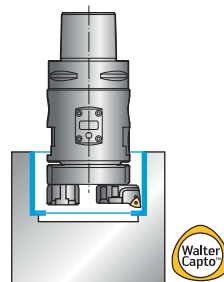



Product range overview of counterboring tools, precision boring tools and reaming tools



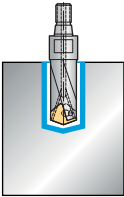
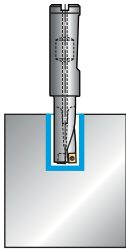
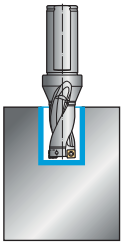
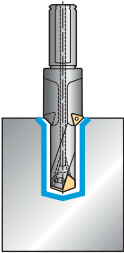

Counterboring	Precision boring, analogue		Precision boring, digital	Reaming
 <p>Walter Boring twin lip boring tools</p> <p>For Walter Select, see page C-42</p>	 <p>Walter Precision boring tools</p> <p>Walter Select See page C-42</p>		 <p>Walter Precision^{DIGITAL} precision boring tools</p> <p>For Walter Select, see page C-43</p>	 <p>Walter reaming tools</p> <p>For Walter Select, see page C 43</p>
<p>Walter Boring^{MEDIUM} B 3220 / B 3221 Page C-44</p> <p>NEW</p> <p>$D_c = 20-153 \text{ mm}$</p>  	<p>Walter Precision^{MINI} B 3230 Page C-52</p> <p>NEW</p> <p>$D_c = 2-45 \text{ mm}$</p>  	<p>Walter Precision^{MINI} B 4030 Page C-52</p> <p>NEW</p> <p>$D_c = 5,8-45,5 \text{ mm}$</p>  	<p>Walter Precision^{DIGITAL} B 4035 Page C-52</p> <p>NEW</p> <p>$D_c = 3-20 \text{ mm}$</p>  	<p>R 4060 Page C 122*</p> <p>$D_c = 6-25 \text{ mm}$</p> 
<p>Walter Precision^{MEDIUM} B 3230 Page C-62</p> <p>NEW</p> <p>$D_c = 15-203 \text{ mm}$</p>  	<p>Walter Precision^{MEDIUM} B 4030 Page C-64</p> <p>NEW</p> <p>$D_c = 33-153 \text{ mm}$</p>  	<p>Walter Precision^{DIGITAL} B 4035 Page C-74</p> <p>NEW</p> <p>$D_c = 20-68 \text{ mm}$</p>  	<p>R 4061 Page C 124*</p> <p>$D_c = 8-25 \text{ mm}$</p> 	
<p>Walter Boring^{MAXI} B 3220 B 3224 Page C-48 Page C-50</p> <p>NEW</p> <p>$D_c = 150-640 \text{ mm}$</p>  	<p>Walter Precision^{MAXI} B 3230 B 3234 Page C-66 Page C-68</p> <p>NEW</p> <p>$D_c = 150-640 \text{ mm}$</p>  	<p>Walter Precision^{DIGITAL} B 4035 Page C-74</p> <p>NEW</p> <p>$D_c = 68-124 \text{ mm}$</p>  		

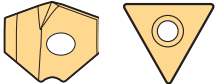
* The pages indicated in italics refer to the Walter General catalogue 2012.

Walter Select – Drilling

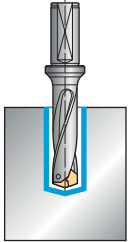
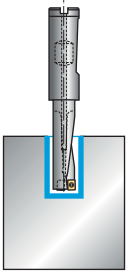
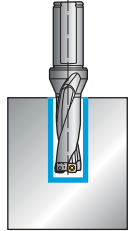
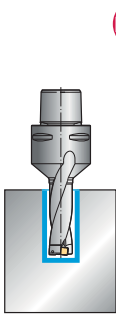
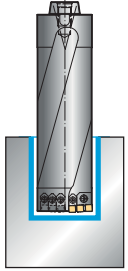
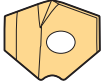
Tool type					
L_c ca.	$1,3 \times D_c$	$2 \times D_c$		$2,5 \times D_c$	
Drills (R) = right handed	B 4011 (R)	B 3212 (R)	B 4212 (R)	B 4012C (R)	
					
	Xtra-tec®		Xtra-tec®	Xtra-tec®	
\emptyset range [mm]	12–25,99	10–18	13,5–59	12–29,99	
Page	<i>C 50*</i>	<i>C 56*</i>	<i>C 52*</i>	<i>C 60*</i>	
P Steel	●●	●●	●●	●●	
M Stainless steel	●●	●●	●●	●●	
K Cast iron	●●	●●	●●	●●	
N NF metals	●●	●	●	●●	
S Difficult-to-machine materials	●●	●●	●●	●●	
H Hard materials					
O Other					
Basic insert shape					
Insert types	P 600 ..	LCMX ..	P 484 ..	P 600 .. TC ..	
Drilling depth [mm]	$\leq 1,3 \times D_c$	$\leq 2 \times D_c$	$\leq 2 \times D_c$	$\leq 2,5 \times D_c$	

* The pages indicated in italics refer to the Walter General catalogue 2012.

3 x D _c					
	B 4013 (R)	B 3213 (R)	B 4213 (R)	B 4213.C	B 4213.N
					
	Xtra-tec®		Xtra-tec®	Xtra-tec®	Xtra-tec®
	12-37,99	10-18	13,5-59	16-45	65-80
	C 62*	C 70*	C 64*	C-38	C 68*
	••	••	••	••	••
	••	••	••	••	•
	••	••	••	••	••
	••	•	•	•	•
	••	••	••	••	•
					
	P 600 ..	LCMX ..	P 484 ..	P 484 ..	P 484 ..
	≤ 3 x D _c	≤ 3 x D _c	≤ 3 x D _c	≤ 3 x D _c	≤ 3 x D _c



Walter Select – Drilling

Tool type					
L_c ca.	$4 \times D_c$		$5 \times D_c$		
Drills (R) = right handed	B 3214 (R)	B 4214 (R)	B 4015 (R)	B 4215 (R)	
			Xtra-tec®	Xtra-tec®	
\emptyset range [mm]	10–18	17–59	12–37,99	17–59	
Page	<i>C 78*</i>	<i>C 74*</i>	<i>C 80*</i>	<i>C 82*</i>	
P Steel		••	••	••	
M Stainless steel		•	••		
K Cast iron	••	••	••	••	
N NF metals	•	•	••	•	
S Difficult-to-machine materials		•	••		
H Hard materials					
O Other					
Basic insert shape					
Insert types	LCMX ..	P 484 ..	P 600 ..	P 484 ..	
Drilling depth [mm]	$\leq 4 \times D_c$	$\leq 4 \times D_c$	$\leq 5 \times D_c$	$\leq 5 \times D_c$	

* The pages indicated in italics refer to the Walter General catalogue 2012.

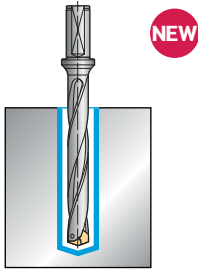
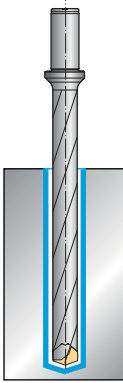
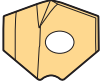
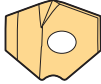
	7 x D _C	10 x D _C
	B 4017 (R)	B 4010 (R)
		
	Xtra-tec®	Xtra-tec®
	12-37,99	18-24,99
	C-40	C 88*
	••	••
	••	••
	••	••
	•	•
	•	•
		
	P 600 ..	P 600 ..
	≤ 7 x D _C	≤ 10 x D _C

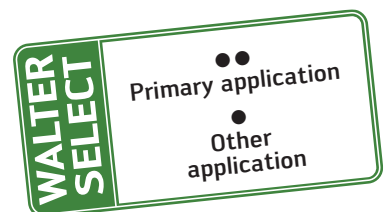

Drill B 4213.C

Xtra-tec® Insert Drill

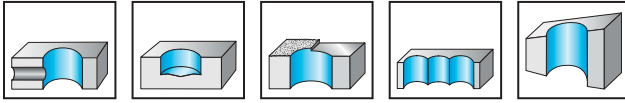

- Diameter range 16-45 mm
- Right-hand cutting
- Drilling depth 3 x D_c

Tool	Designation	D _c mm	d ₁ mm	l ₄ mm	L _c mm	kg	No. of indexable inserts	Type
	★ B4213.C4.16.Z1.048R-1	16	C4	88	48	0,37	1 1	P484.P-1R P484.C-1R
	★ B4213.C4.20.Z1.060R-2	20	C4	100	60	0,43	1 1	P484.P-2R P484.C-2R
	★ B4213.C4.25.Z1.075R-4	25	C4	115	75	0,5	1 1	P484.P-4R P484.C-4R
	★ B4213.C4.32.Z1.096R-5	32	C4	140	96	0,7	1 1	P484.P-5R P484.C-5R
	★ B4213.C5.16.Z1.048R-1	16	C5	92	48	0,7	1 1	P484.P-1R P484.C-1R
	★ B4213.C5.20.Z1.060R-2	20	C5	105	60	0,7	1 1	P484.P-2R P484.C-2R
	★ B4213.C5.25.Z1.075R-4	25	C5	120	75	0,8	1 1	P484.P-4R P484.C-4R
	★ B4213.C5.32.Z1.096R-5	32	C5	140	96	0,9	1 1	P484.P-5R P484.C-5R
	★ B4213.C5.40.Z1.120R-6	40	C5	165	120	1,3	1 1	P484.P-6R P484.C-6R
	★ B4213.C6.25.Z1.075R-4	25	C6	125	75	1,3	1 1	P484.P-4R P484.C-4R
	★ B4213.C6.32.Z1.096R-5	32	C6	145	96	1,4	1 1	P484.P-5R P484.C-5R
	★ B4213.C6.40.Z1.120R-6	40	C6	170	120	1,7	1 1	P484.P-6R P484.C-6R
	★ B4213.C6.45.Z1.135R-7	45	C6	185	135	2	1 1	P484.P-7R P484.C-7R

For possible X adjustment for drilling into solid material, see page C 176 of the Walter General catalogue 2012.

Bodies and assembly parts are included in the scope of delivery.

Important: Where through bores are created by a rotating tool, a disc forms which is ejected. Please implement safety measures.

Assembly parts

D _c mm	16	20	25	32	40	45
Clamping screw for insert	FS2120 (Torx 6IP)	FS2111 (Torx 7IP)	FS1457 (Torx 9IP)	FS2080 (Torx 15IP)	FS1453 (Torx 15IP)	FS1495 (Torx 20IP)
Tightening torque	0,4 Nm	0,9 Nm	2,0 Nm	2,5 Nm	3,5 Nm	5,0 Nm

Accessories

D _c mm	16	20	25	32-40	45
Torque screwdriver	FS2001	FS2001	FS2003	FS2003	FS2003
Interchangeable blade	FS2085 (Torx 6IP)	FS2011 (Torx 7IP)	FS2013 (Torx 9IP)	FS2014 (Torx 15IP)	FS2015 (Torx 20IP)

Indexable inserts

	Size	P			M	K		S	HC
		WKP 25S	WKP 35S	WSP 45	WSP 45	WKP 25S	WKP 35S	WSP 45	WXP 40
Outer insert 	P4840P- . R-A57								
	P4840P- . R-E57								
	P4840P- . R-E67								
	P4841P- . R-A57								
	P4841P- . R-E57								
Centre insert 	P4841C- . R-A57								
	P4841C- . R-E57								
	P4840C- . R-E67								

HC = Coated carbide

WALTER SELECT

Best insert for:

good

moderate

unfavourable

machining conditions

Drill B 4017

Xtra-tec® Point Drill

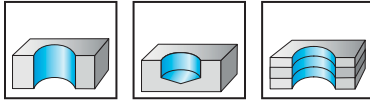

- Diameter range 12-37.99 mm
- Right-hand cutting
- Drilling depth 7 x D_C

Tool	Designation	D _C mm	d ₁ mm	d ₄ mm	l ₄ mm	l ₅ mm	L _C mm	Z	kg	No. of index- able inserts	Type
Parallel shank with flat in acc. with ISO 9767	B4017.F20.12,0.Z02.84R	12	20	30	116	50	86	2	0,23	1	P 600 . - D12 . . R
	B4017.F20.13,0.Z02.91R	13	20	30	124	50	93	2	0,25	1	P 600 . - D13 . . R
	B4017.F20.14,0.Z02.98R	14	20	30	132	50	101	2	0,27	1	P 600 . - D14 . . R
	B4017.F20.15,0.Z02.105R	15	20	30	140	50	108	2	0,29	1	P 600 . - D15 . . R
	B4017.F20.16,0.Z02.112R	16	20	30	148	50	115	2	0,31	1	P 600 . - D16 . . R
	B4017.F20.17,0.Z02.119R	17	20	30	156	50	122	2	0,35	1	P 600 . - D17 . . R
	B4017.F20.18,0.Z02.126R	18	20	30	164	50	126	2	0,34	1	P 600 . - D18 . . R
	B4017.F20.19,0.Z02.133R	19	20	30	172	50	136	2	0,37	1	P 600 . - D19 . . R
	B4017.F20.20,0.Z02.140R	20	20	30	180	50	144	2	0,41	1	P 600 . - D20 . . R
	B4017.F20.21,0.Z02.147R	21	20	30	188	50	151	2	0,45	1	P 600 . - D21 . . R
	B4017.F25.22,0.Z02.154R	22	25	35	197	56	158	2	0,6	1	P 600 . - D22 . . R
	B4017.F25.23,0.Z02.161R	23	25	35	205	56	165	2	0,7	1	P 600 . - D23 . . R
	B4017.F25.24,0.Z02.168R	24	25	35	213	56	172	2	0,7	1	P 600 . - D24 . . R
	B4017.F25.25,0.Z02.175R	25	25	35	221	56	180	2	0,8	1	P 600 . - D25 . . R
	B4017.F25.26,0.Z02.182R	26	25	35	229	56	187	2	0,8	1	P 600 . - D26 . . R
	B4017.F25.27,0.Z02.189R	27	25	35	237	56	194	2	0,9	1	P 600 . - D27 . . R
	B4017.F32.28,0.Z02.196R	28	32	42	246	60	201	2	1,2	1	P 600 . - D28 . . R
	B4017.F32.29,0.Z02.203R	29	32	42	254	60	208	2	1,2	1	P 600 . - D29 . . R
	B4017.F32.30,0.Z02.210R	30	32	42	262	60	215	2	1,2	1	P 600 . - D30 . . R
	B4017.F32.31,0.Z02.217R	31	32	42	270	60	223	2	1,4	1	P 600 . - D31 . . R
	★ B4017.F40.32,0.Z02.224R	32	40	50	278	70	230	2	1,7	1	P 600 . - D32 . . R
	★ B4017.F40.33,0.Z02.231R	33	40	50	286	70	237	2	1,8	1	P 600 . - D33 . . R
	★ B4017.F40.34,0.Z02.238R	34	40	50	294	70	244	2	1,9	1	P 600 . - D34 . . R
★ B4017.F40.35,0.Z02.245R	35	40	50	302	70	251	2	2,1	1	P 600 . - D35 . . R	
★ B4017.F40.36,0.Z02.252R	36	40	50	310	70	259	2	2,1	1	P 600 . - D36 . . R	
★ B4017.F40.37,0.Z02.259R	37	40	50	318	70	259	2	2,3	1	P 600 . - D37 . . R	
Parallel shank with collar	B4017.ZB20.12,0.Z02.84R	12	20	30	116	50	84	2	0,24	1	P 600 . - D12 . . R
	B4017.ZB20.13,0.Z02.91R	13	20	30	124	50	91	2	0,26	1	P 600 . - D13 . . R
	B4017.ZB20.14,0.Z02.98R	14	20	30	132	50	98	2	0,27	1	P 600 . - D14 . . R
	B4017.ZB20.15,0.Z02.105R	15	20	30	140	50	105	2	0,31	1	P 600 . - D15 . . R
	B4017.ZB20.16,0.Z02.112R	16	20	30	148	50	112	2	0,31	1	P 600 . - D16 . . R
	B4017.ZB20.17,0.Z02.119R	17	20	30	156	50	119	2	0,34	1	P 600 . - D17 . . R
	B4017.ZB20.18,0.Z02.126R	18	20	30	164	50	126	2	0,34	1	P 600 . - D18 . . R
	B4017.ZB20.19,0.Z02.133R	19	20	30	172	50	136	2	0,37	1	P 600 . - D19 . . R
	B4017.ZB20.20,0.Z02.140R	20	20	30	180	50	144	2	0,41	1	P 600 . - D20 . . R
	B4017.ZB20.21,0.Z02.147R	21	20	30	188	50	151	2	0,45	1	P 600 . - D21 . . R
	B4017.ZB25.22,0.Z02.154R	22	25	35	197	56	158	2	0,6	1	P 600 . - D22 . . R
	B4017.ZB25.23,0.Z02.161R	23	25	35	205	56	165	2	0,7	1	P 600 . - D23 . . R
	B4017.ZB25.24,0.Z02.168R	24	25	35	213	56	172	2	0,7	1	P 600 . - D24 . . R
	B4017.ZB25.25,0.Z02.175R	25	25	35	221	56	180	2	0,8	1	P 600 . - D25 . . R
	B4017.ZB25.26,0.Z02.182R	26	25	35	229	56	187	2	0,8	1	P 600 . - D26 . . R
	B4017.ZB25.27,0.Z02.189R	27	25	35	237	56	194	2	0,9	1	P 600 . - D27 . . R
	B4017.ZB32.28,0.Z02.196R	28	32	42	246	60	201	2	1,2	1	P 600 . - D28 . . R
	B4017.ZB32.29,0.Z02.203R	29	32	42	254	60	208	2	1,3	1	P 600 . - D29 . . R
	B4017.ZB32.30,0.Z02.210R	30	32	42	262	60	215	2	1,3	1	P 600 . - D30 . . R
	B4017.ZB32.31,0.Z02.217R	31	32	42	270	60	223	2	1,4	1	P 600 . - D31 . . R

When using this drill, a centre hole produced by a B 4013 or NC centring drill is recommended.





Bodies and assembly parts are included in the scope of delivery.

* Example: Inserts with D_C = 12.00 mm up to and incl. 12.99 mm can fitted into this tool.







Assembly parts

D _c mm	12-13	14-15	16-17	18-19	20-21	22-23	24-25	26-27	28-33	34-37
 Clamping screw for insert	FS1396 (Torx 7IP)	FS1397 (Torx 8IP)	FS1398 (Torx 8IP)	FS1399 (Torx 15IP)	FS1400 (Torx 20IP)	FS1401 (Torx 20IP)	FS1402 (Torx 20IP)	FS1403 (Torx 25IP)	FS1404 (Torx 25IP)	FS2159 (Torx 25IP)
Tightening torque	1,2 Nm	2,0 Nm	2,0 Nm	4,0 Nm	5,0 Nm	5,0 Nm	5,0 Nm	5,5 Nm	5,5 Nm	5,5 Nm

Accessories









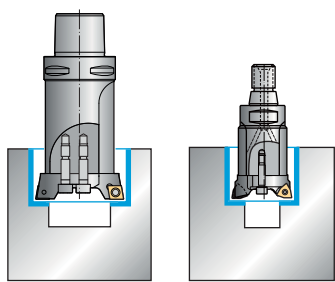

D _c mm	12-13	14-17	18-19	20-25	26-37
 Torque screwdriver	FS2001	FS2003	FS2003	FS2003	
 Interchangeable blade	FS2011 (Torx 7IP)	FS2012 (Torx 8IP)	FS2014 (Torx 15IP)	FS2015 (Torx 20IP)	FS2049 (Torx 25IP)
 Screwdriver	FS1490 (Torx 7IP)	FS1483 (Torx 8IP)	FS1485 (Torx 15IP)	FS1486 (Torx 20IP)	FS1487 (Torx 25IP)
 T-handle torque wrench					FS2041

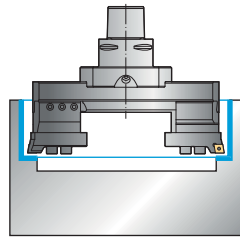
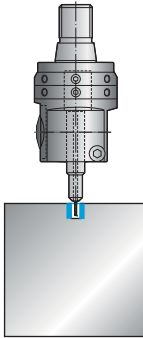
Indexable inserts

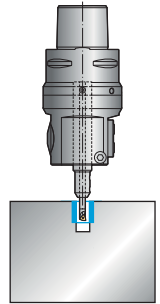
Designation	Diameter range	P			M	K	N	S	H
		HC	HC	HC	HC	HC	HC	HC	
		WMP35	WXP45	WPP45C	WMP35	WXX25	WNN25	WMP35	
P6001-D ..	12-37,99								
P6002-D ..	12-31,99								
P6003-D ..	12-37,99								
P6004-D ..	12-31,50								

HC = Coated carbide

Walter Select – Counterboring/precision boring and reaming

Tool type	Boring tools			Precision boring tools			
	Walter Boring ^{MEDIUM}			Walter Precision ^{MINI}			
	B 3220 B 3221  			B 3220 B 3224  		B 3230 	B 3230 B 4030  
Ø range [mm]	20–153			150–640		2–6	5.8–45.5
Page	C-44			C-48		C-52	C-52
P Steel	●●			●●		●●	●●
M Stainless steel	●●			●●		●●	●●
K Cast iron	●●			●●		●●	●●
N NF metals	●			●		●	●●
S Difficult-to-machine materials	●●			●●		●	●●
H Hard materials							●
O Other							●
Basic insert shape					—		
Insert types	CC .. 0602 .. CC .. 09T3 .. CC .. 1204 ..	SC .. 0602 .. SC .. 09T3 .. SC .. 1204 ..	WC .. 0302 .. WC .. 0402 .. WC .. 06T3 .. WC .. 0804 ..	CC .. 1204 ..	—	WC .. 0201 .. WC .. 0302 .. WC .. 0402 ..	
Cutting depth a_p [mm]	max. 12	max. 12	max. 8	max. 12	max. 0.5	max. 0.5	

Precision boring tools						Reaming tools	
Walter Precision ^{MEDIUM}			Walter Precision ^{MAXI}				
B 3230		B 4030	B 3230 B 3234		B 4035	R 4060	R 4061
15-70	20-203	33-153	150-640	3-124	6-25	8-25	
C-60	C-62	C-64	C-66	C-70	<i>C 122*</i>	<i>C 124*</i>	
••	••	••	••	••	••	••	
••	••	••	••	••	••	••	
••	••	••	••	••	••	••	
••	••	••	••	••	••	••	
••	••	••	••	••	••	••	
•	•		•	•			
•	•	•	•	•			
CP...0502... CC...0602...	WC...0302... WC...0402... WC...0503...	WC...0302... WC...0402... CP...0502... CC...0602...	CC...0602.../ WC...0503...	WC...0302 WC...0402	P 6500...	P 6500...	
max. 1	max. 1	max. 1	max. 1	max. 1			

* The pages indicated in italics refer to the Walter General catalogue 2012.



Two flute boring tool B 3220 / B 3221

Walter Boring^{MEDIUM}

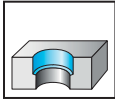



- Ø 20–41 mm
- κ = 90°
- Z = 2



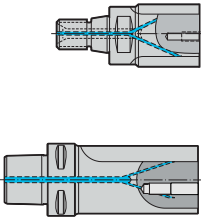

Basic body

Cartridge with C insert



Tool	Basic body Designation	d ₁ mm	D _c mm	Cartridge Designation	Type
NCT ScrewFit 	B3221G.T18.20–27.Z2	T18	20–24	EB401.CC06	CC . . 0602 . .
	B3221G.T22.26–33.Z2		23–27	EB402.CC06	
	B3221G.T28.33–41.Z2	T22	26–33	EB403.CC06	
	B3220G.T28.33–41.Z2	T28	33–41	EB205–206.CC06	
Walter Capto™ 	★ B3221G.C3.020-027.Z2	C3	20–24	EB401.CC06	CC . . 0602 . .
	★ B3221G.C3.026-035.Z2		23–27	EB402.CC06	
	★ B3220G.C3.033-044.Z2	C3	26–33	EB403.CC06	
		C3	33–41	EB205–206.CC06	

For assembly aids, see page G 28 and G 105 of the Walter General catalogue 2012.
Bodies and assembly parts are included in the scope of delivery.

Assembly parts	D _c min–max [mm]			
	20–27	26–33	33–41	
	Adjusting screw	FS 1103 (SW 1,3)	FS 1104 (SW 1,3)	FS 1105 (SW 1,5)
	Spring washer	FS 1098		FS 1099
	Clamping screw for cartridge	FS 1093 (SW 3)		FS 1094 (SW 4)
	Tightening torque	4 Nm		7 Nm
	Clamping screw for indexable insert CC . . 0602 + WC . . 0402	FS 1454 (Torx 8IP)		
	Tightening torque	0,8 Nm		
	Clamping screw for indexable insert WC . . 0302	FS 2084 (Torx 7IP)		
	Tightening torque	0,9 Nm		

★ New addition to range



Cartridge with W insert



Complete tool

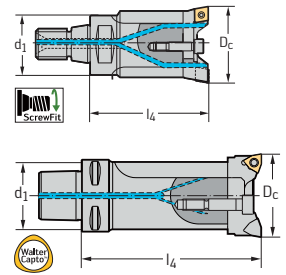



Cartridge Designation	Type	d ₁ mm	l ₄ mm	kg	Complete tool Designation with C insert	Complete tool Designation with W insert
EB421.WC03	WC . . 0302 . .	19	35	0,1	B3221.T18.20-24.Z2.CC06	B3221.T18.20-24.Z2.WC03*
EB422.WC03		19	35	0,1	B3221.T18.23-27.Z2.CC06	B3221.T18.23-27.Z2.WC03*
EB423.WC03		22	40	0,1	B3221.T22.26-33.Z2.CC06	B3221.T22.26-33.Z2.WC03*
EB225-226.WC04	WC . . 0402 . .	28	55	0,3	B3220.T28.33-41.Z2.CC06	B3220.T28.33-41.Z2.WC04*
EB421.WC03	WC . . 0302 . .	32	80	0,3	★ B3221.C3.020-024.Z2.CC06	★ B3221.C3.020-024.Z2.WC03
EB422.WC03		32	80	0,3	★ B3221.C3.023-027.Z2.CC06	★ B3221.C3.023-027.Z2.WC03
EB423.WC03		32	80	0,4	★ B3221.C3.026-033.Z2.CC06	★ B3221.C3.026-033.Z2.WC03
EB225-226.WC04	WC . . 0402 . .	32	80	0,6	★ B3220.C3.033-041.Z2.CC06	★ B3220.C3.033-041.Z2.WC04

* NB: The projection of the cartridges must be sufficient for chip removal where used with extension in blind bores.

Accessories

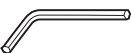
D_c min-max [mm]

	20-33 (CC . . 0602 + WC . . 0402)	33-41 (WC . . 0302)
 Screwdriver for clamping screw FS 1454	FS 1483 (Torx 8IP)	FS 1490 (Torx 7IP)
 Screwdriver for clamping screw FS 2084	FS 1490 (Torx 7IP)	FS 1490 (Torx 7IP)
 Allen key DIN 911	SW 1,3 / SW 3	SW 1,5 / SW 4

Torque screwdriver with interchangeable blades, see page H-2.

★ New addition to range

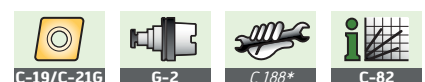

Two flute boring tool B 3220 / B 3221

Walter Boring^{MEDIUM}

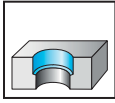

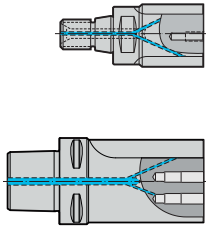

- Ø 41–153 mm
- κ = 90°
- Z = 2

Basic body







Cartridge with C insert

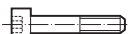

Tool	Basic body Designation	d ₁ mm	D _c mm	Cartridge Designation	Type
NCT ScrewFit 	B3220G.T36.41–55.Z2	T36	41–55	EB207–208.CC09	CC...09T3...
	B3220G.T45.55–70.Z2	T45	55–70	EB209–210.CC09	
Walter Capto™ 	★ B3220G.C4.041–056.Z2	C4	41–55	EB207–208.CC09	CC...09T3...
	★ B3220G.C5.055–073.Z2	C5	55–70	EB209–210.CC09	
	★ B3220G.C6.070–93.Z2	C6	70–90	EB211–212.CC12	CC...1204...
	★ B3220G.C8.090–113.Z2	C8	90–110	EB213–214.CC12	
	★ B3220G.C8.110–153.Z2	C8	110–133	EB215.CC12	
130–153			EB216.CC12		

For assembly aids, see page G 28 and G 105 of the Walter General catalogue 2012.
Bodies and assembly parts are included in the scope of delivery.

Assembly parts	D _c min–max [mm]			
	41–70	70–90	90–110	110–153
	Adjusting screw	FS 1106 (SW 2)	FS 1107 (SW 2,5) FS 1108 (SW 2,5)	
	Spring washer	FS 1100	FS 1101	FS 1102
	Clamping screw for cartridge	FS 1095 (SW 5)	FS 1096 (SW 6)	FS 1097 (SW 8)
	Tightening torque	12 Nm	30 Nm	50 Nm
	Clamping screw for insert	FS 2062 (Torx 15IP)	FS 1495 (Torx 20IP)	
	Tightening torque	3,0 Nm	5,0 Nm	

★ New addition to range



Cartridge with W insert

Complete tool

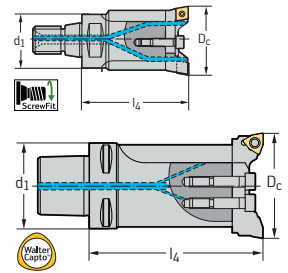

Cartridge Designation	Type	d ₁ mm	l ₄ mm	kg	Complete tool designation with C insert	Complete tool designation with W insert
EB227-228.WC06	WC...06T3...	36	65	0,5	B3220.T36.41-55.Z2.CC09	B3220.T36.41-55.Z2.WC06*
EB229-230.WC06		45	80	0,9	B3220.T45.55-70.Z2.CC09	B3220.T45.55-70.Z2.WC06*
EB227-228.WC06	WC...06T3...	40	80	1,0	★ B3220.C4.041-055.Z2.CC09	★ B3220.C4.041-055.Z2.WC06
EB229-230.WC06		50	100	1,8	★ B3220.C5.055-070.Z2.CC09	★ B3220.C5.055-070.Z2.WC06
EB231-232.WC08	WC...0804...	63	110	2,7	★ B3220.C6.070-090.Z2.CC12	★ B3220.C6.070-090.Z2.WC08
EB233-234.WC08		80	110	4,2	★ B3220.C8.090-110.Z2.CC12	★ B3220.C8.090-110.Z2.WC08
EB235.WC08		80	110	5,2	★ B3220.C8.110-133.Z2.CC12	★ B3220.C8.110-133.Z2.WC08
EB236.WC08		80	110	5,3	★ B3220.C8.130-153.Z2.CC12	★ B3220.C8.130-153.Z2.WC08

* NB: The projection of the cartridges must be sufficient for chip removal where used with extension in blind bores.

Accessories

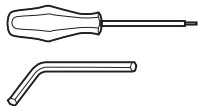

		D _c min-max [mm]	
		41-70	70-153
Screwdriver for clamping screw	FS 1485 (Torx 15IP)	FS 1486 (Torx 20IP)	
Allen key DIN 911	SW 2 / SW 5	SW 2,5 / SW 6 / SW 8	

Torque screwdriver with interchangeable blades, see page H-2.

★ New addition to range



Two flute boring tool with bridge B 3220

Walter Boring^{MAXI}

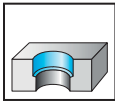

- Ø 150–640 mm
- $\kappa = 90^\circ$
- Z = 2
- Aluminium bridge

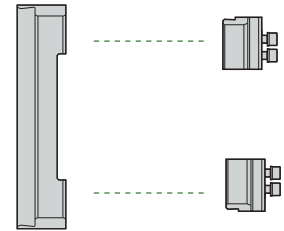
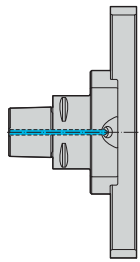

Basic body

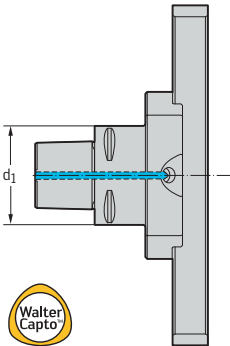

Tool	Basic body Designation	d ₁ mm	D _c mm	Bridge designation	Cartridge holder designation
Walter Capto™ 	★ B3223G.C8.150–640	C8	150–220	★ EB134AL	EB122
			220–290	★ EB135AL	
			290–360	★ EB136AL	
			360–430	★ EB137AL	
			430–500	★ EB138AL	
			500–570	★ EB139AL	
			570–640	★ EB140AL	

For assembly aids, see page G 28 of the Walter General catalogue 2012.
Bodies and assembly parts are included in the scope of delivery.

Assembly parts

		Designation	Tightening torque
	Clamping screw for bridge	FS 1114 (SW 10)	120 Nm
	Clamping screw for cartridge holder	FS 1113 (SW 6)	25 Nm
	Fitting screw	FS 1097 (SW 8)	50 Nm
	Spring washer	FS 1102	
	Adjusting screw	FS 1109 (SW 2,5)	
	Clamping screw for insert	FS 1495 (Torx 20IP)	5 Nm

★ New addition to range



Cartridge with C insert

Complete tool

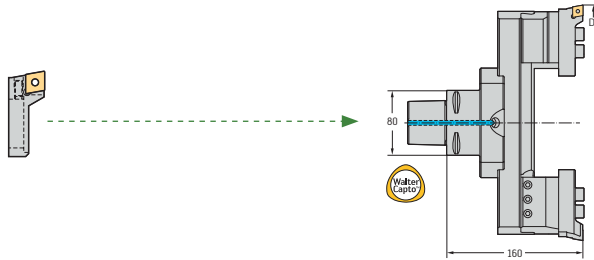

Cartridge designation	Type	kg	Complete tool Designation with C insert
EB217.CC12	CCMT 12 . .	6,3	★ B3220.C8.150-220.Z2.CC12
		6,8	★ B3220.C8.220-290.Z2.CC12
		7,2	★ B3220.C8.290-360.Z2.CC12
		7,5	★ B3220.C8.360-430.Z2.CC12
		7,9	★ B3220.C8.430-500.Z2.CC12
		8,2	★ B3220.C8.500-570.Z2.CC12
		8,4	★ B3220.C8.570-640.Z2.CC12

Accessories

	Screwdriver for clamping screw	FS 1486 (Torx 20IP)
	Allen key DIN 911	SW 2,5 / SW 6 / SW 8 / SW 10

Torque screwdriver with interchangeable blades, see page H-2.



★ New addition to range

Two flute boring tool with bridge B 3224

Walter Boring^{MAXI}

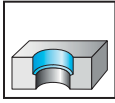

- Ø 150–640 mm
- $\kappa = 90^\circ$
- $Z = 2$
- NCT flute orientation rotated by 90° in relation to B3220
- Aluminium bridge



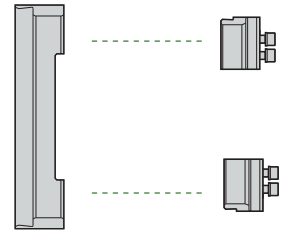
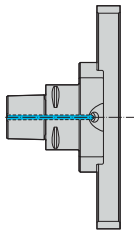

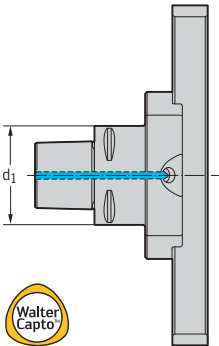

Basic body

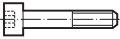

Tool	Basic body Designation	d_1 mm	D_c mm	Bridge designation	Cartridge holder designation
Walter Capto™  	★ B3224G.C8.150–640	C8	150–220	★ EB134AL	EB122
			220–290	★ EB135AL	
			290–360	★ EB136AL	
			360–430	★ EB137AL	
			430–500	★ EB138AL	
			500–570	★ EB139AL	
			570–640	★ EB140AL	

For assembly aids, see page G 28 of the Walter General catalogue 2012.
Bodies and assembly parts are included in the scope of delivery.

Assembly parts

	Designation	Tightening torque
	Clamping screw for bridge FS 1114 (SW 10)	120 Nm
	Clamping screw for cartridge holder FS 1113 (SW 6)	25 Nm
	Fitting screw FS 1097 (SW 8)	50 Nm
	Spring washer FS 1102	
	Adjusting screw FS 1109 (SW 2,5)	
	Clamping screw for insert FS 1495 (Torx 20IP)	5 Nm

★ New addition to range



Cartridge with C insert

Complete tool

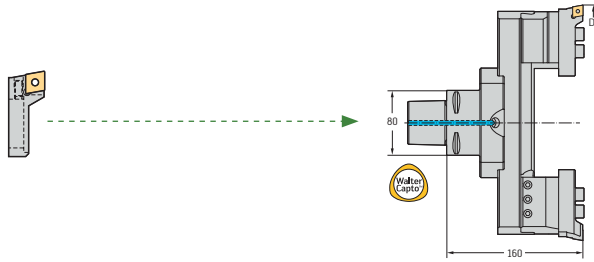

Cartridge designation	Type	kg	Complete tool Designation with C insert
EB217.CC12	CCMT 12 . .	6,3	★ B3224.C8.150-220.Z2.CC12
		6,8	★ B3224.C8.220-290.Z2.CC12
		7,2	★ B3224.C8.290-360.Z2.CC12
		7,5	★ B3224.C8.360-430.Z2.CC12
		7,9	★ B3224.C8.430-500.Z2.CC12
		8,2	★ B3224.C8.500-570.Z2.CC12
		8,4	★ B3224.C8.570-640.Z2.CC12

Accessories

	Screwdriver for clamping screw	FS 1486 (Torx 20IP)
	Allen key DIN 911	SW 2,5 / SW 6 / SW 8 / SW 10

Torque screwdriver with interchangeable blades, see page H-2.



★ New addition to range

Precision boring tool B 3230 / B 4030

Walter Precision^{MINI}

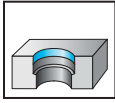

- Ø 2.0–9.5 mm
- κ = 93°
- Z = 1

Basic body

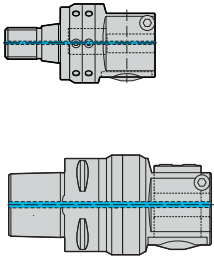

Reduction

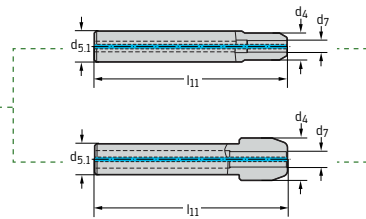

Tool	Basic body Designation	d ₁ mm	D _c mm	Designation	d ₇ mm	d ₄ mm	d _{5.1} mm	l ₁₁ mm
NCT ScrewFit 	B4030G.T45.02-20.Z1 Balanceable	T45	2.0–3.5	EB501	4	12	12	85
				EB502	5	12	12	85
				EB503	6	22	12	85
				EB501	4	12	16	100
Walter Capto™ 	★ B3230G.C6.02-45.Z1 Standard	C6	2.0–3.5	EB101	4	12	16	100
				EB102	5	13	16	100
				EB103	6	14	16	100
				EB101	4	12	16	100
	★ B4030G. C6.02-45.Z1 balanceable							

For assembly aids, see page G 28 and G 105 of the Walter General catalogue 2012.
Bodies and assembly parts are included in the scope of delivery.

Assembly parts	Designation	d ₁ = T45		d ₁ = C6	
		Designation	Tightening torque	Designation	Tightening torque
	Clamping screw	FS 1084 (SW 4)	4,0 Nm	FS 1085 (SW 5)	10 Nm
	Clamping screw for reduction	FS 2039 (SW 4)	7,0 Nm	FS 1112 (SW 5)	14 Nm
	Clamping screw for insert holder	FS 1110 (SW 2)	1,9 Nm	FS 1110 (SW 2)	1,9 Nm
	Clamping screw for indexable insert with D _c = 5.8–9.5 mm	FS 2245 (Torx 6IP)	0,6 Nm	FS 2245 (Torx 6IP)	0,6 Nm
	Clamping screw for balancing rings	FS 2037 (SW 2)		FS 2038 (SW 2)	



Insert holder

Complete tool

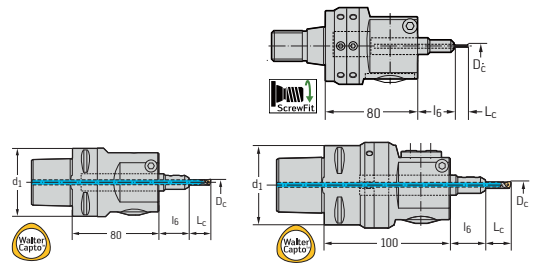
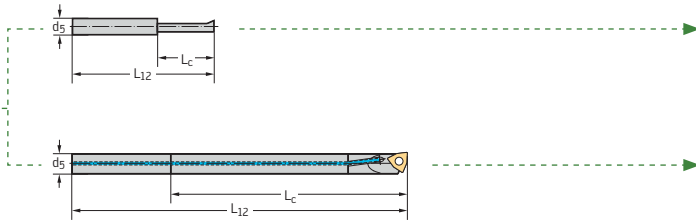

Designation	d ₅ mm	L ₁₂ mm	Type	L _c min mm	L _c max mm	l ₆ mm	kg	Complete tool Designation	Complete tool balanceable Designation
EB301.WK10*	4	30	—	9	—	30–53	0,8		B4030.T45.02-03.Z1.WK10
EB302.WK10*	4	35	—	14	—	30–53	0,8		B4030.T45.03-06.Z1.WK10
EB303.WC02.CS	5	85	WC...0201...	20	60	30–53	0,8		B4030.T45.06-07.Z1.WC02
EB304.WC02.CS	6	95	WC...0201...	20	65	30–53	0,8		B4030.T45.07-09.Z1.WC02
EB301.WK10*	4	30	—	9	—	28–60	1,8	★ B3230.C6.02-03.Z1.WK10	★ B4030.C6.02-03.Z1.WK10
EB302.WK10*	4	35	—	14	—	28–60	1,8	★ B3230.C6.03-06.Z1.WK10	★ B4030.C6.03-06.Z1.WK10
EB303.WC02.CS	5	85	WC...0201...	20	60	28–60	1,8	★ B3230.C6.06-07.Z1.WC02	★ B4030.C6.06-07.Z1.WC02
EB304.WC02.CS	6	95	WC...0201...	20	65	28–60	1,8	★ B3230.C6.07-09.Z1.WC02	★ B4030.C6.07-09.Z1.WC02

* Boring bar made from solid carbide EB...CS = Solid carbide shank
Advantages: Increased rigidity, reduced deflection, neutralised vibration

Accessories

	Screwdriver for clamping screw	FS 2086 (Torx 6IP)
	Allen key DIN 911	SW 2 / SW 4 / SW 5
	One-piece boring bar	For D _c 5.8–9.5, see page C-58

Torque screwdriver with interchangeable blades, see page H-2.



Precision boring tool B 3230 / B 4030

Walter Precision^{MINI}

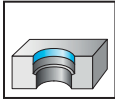

- Ø 8,8–20 mm
- κ = 93°
- Z = 1

Basic body

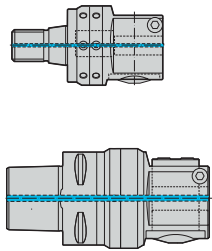

Reduction

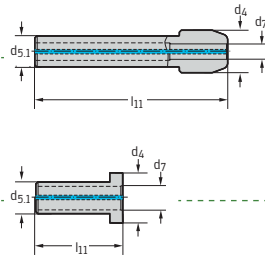

Extension

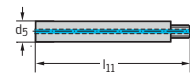

Tool	Basic body Designation	d ₁ mm	D _C mm	Designation	d ₇ mm	d ₄ mm	d _{5,1} mm	l ₁₁ mm	Designation	d ₅ mm	l ₁₁ mm					
NCT ScrewFit B4030G.T45.02-20.Z1 Balanceable	T45	8,8–12,5	EB504	8	14	12	30	EB106	8	47						
								EB107.CS	8	87						
								11,8–14,5	EB505	10	14	12	30	EB108	10	52
														EB109.CS	10	77
								13,8–16,5	—	—	—	—	—	EB508	12	77
														EB509.CS	12	97
EB508	12	77														
EB509.CS	12	97														
Walter Capto™ ★ B3230G.C6.002-045.Z1 Standard ★ B4030G.C6.02-45.Z1 balanceable	C6	8,8–12,5	EB104	8	22	16	100	EB106	8	47						
								EB107.CS	8	87						
		11,8–14,5	EB105	10	24	16	100	EB108	10	52						
								EB109.CS	10	77						
		13,8–16,5	EB506	12	17	16	36	EB508	12	77						
								EB509.CS	12	97						
		15,8–20,0	EB507	14	17	16	36	EB510	14	87						
								EB511.CS	14	117						

EB... CS = Solid carbide shank

Advantages: Increased rigidity, reduced deflection, neutralised vibration

Assembly parts	d ₁ = T45				d ₁ = C6	
	Designation	Tightening torque	Designation	Tightening torque	Designation	Tightening torque
	Clamping screw	FS 1084 (SW 4)	4,0 Nm	FS 1085 (SW 5)	10 Nm	
	Clamping screw for reduction	FS 2039 (SW 4)	7,0 Nm	FS 1112 (SW 5)	14 Nm	
	Clamping screw for extension	FS 1110 (SW 2)	1,9 Nm	FS 1111 (SW 3)	5,5 Nm	
	Clamping screw for insert	FS 2084 (Torx 7IP)	0,9 Nm	FS 2084 (Torx 7IP)	0,9 Nm	
	Clamping screw for balancing rings	FS 2037 (SW 2)		FS 2038 (SW 2)		

★ New addition to range



Insert holder

Complete tool

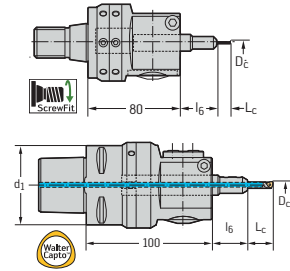
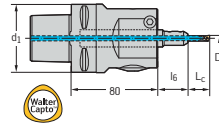

Designation	l ₁₂ mm	Type	L _c min mm	L _c max mm	l ₆ mm	kg	Complete tool Designation	Complete tool balanceable Designation
EB305.WC03	18	WC...0302..	18	33	2	0,8		B4030.T45.09-12.Z1.WC03.S
			35	73	2	0,8		B4030.T45.09-12.Z1.WC03.L
EB306.WC03	23	WC...0302..	23	43	2	0,8		B4030.T45.12-14.Z1.WC03.S
			45	68	2	0,8		B4030.T45.12-14.Z1.WC03.L
EB307.WC03	23	WC...0302..	45	68	—	0,8		B4030.T45.14-16.Z1.WC03.S
			65	88	—	0,9		B4030.T45.14-16.Z1.WC03.L
EB512.WC03	23	WC...0302..	45	68	—	0,8		B4030.T45.16-20.Z1.WC03.S
			65	88	—	0,9		B4030.T45.16-20.Z1.WC03.L
EB305.WC03	18	WC...0302..	20	35	34-60	1,9	★ B3230.C6.09-12.Z1.WC03.S	★ B4030.C6.09-12.Z1.WC03.S
			20	73	34-60	1,9	★ B3230.C6.09-12.Z1.WC03.L	★ B4030.C6.09-12.Z1.WC03.L
EB306.WC03	23	WC...0302..	25	45	34-60	1,9	★ B3230.C6.12-14.Z1.WC03.S	★ B4030.C6.12-14.Z1.WC03.S
			25	70	34-60	1,9	★ B3230.C6.12-14.Z1.WC03.L	★ B4030.C6.12-14.Z1.WC03.L
EB307.WC03	23	WC...0302..	34	60	2	1,9	★ B3230.C6.14-16.Z1.WC03.S	★ B4030.C6.14-16.Z1.WC03.S
			54	80	2	1,9	★ B3230.C6.14-16.Z1.WC03.L	★ B4030.C6.14-16.Z1.WC03.L
EB512.WC03	23	WC...0302..	44	70	2	1,9	★ B3230.C6.16-20.Z1.WC03.S	★ B4030.C6.16-20.Z1.WC03.S
			74	100	2	1,9	★ B3230.C6.16-20.Z1.WC03.L	★ B4030.C6.16-20.Z1.WC03.L

Accessories

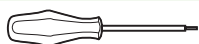

Screwdriver for clamping screw

FS 2088 (Torx 7IP)



Allen key DIN 911

SW 2 / SW 4 / SW 5



One-piece boring bar

For D_c 8.8-15.8, see page C-58

Torque screwdriver with interchangeable blades, see page H-2.



C 27



G-2



C 188*



C-86

★ New addition to range

Precision boring tool

B 3230 / B 4030

Walter Precision^{MINI}

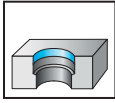

- Ø 17.8–45.5 mm
- κ = 93°
- Z = 1

Basic body

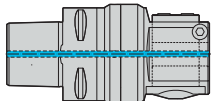

Extension

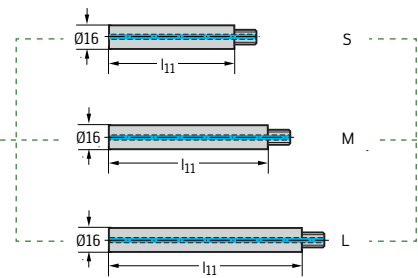

Tool

Basic body
Designation

d₁
mm

D_c
mm

Designation

l₁₁
mm

Walter Capto™

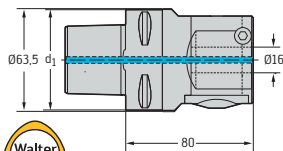

★ B3230G.C6.002-045.Z1
Standard

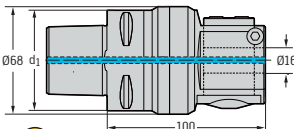

★ B4030G.C6.02-45.Z1
balanceable



Tool	Basic body Designation	d ₁ mm	D _c mm	Designation	l ₁₁ mm		
Walter Capto™	★ B3230G.C6.002-045.Z1 Standard	C6	17,8–22,5	EB110	88	(S)	
				EB111.CS	108	(M)	
				EB112.CS	168	(L)	
			21,8–25,5	EB110	88	(S)	
				EB111.CS	108	(M)	
				EB112.CS	168	(L)	
			24,8–28,5	EB110	88	(S)	
				EB111.CS	108	(M)	
				EB112.CS	168	(L)	
			27,8–32,5	EB110	88	(S)	
				EB111.CS	108	(M)	
				EB112.CS	168	(L)	
31,8–36,5	EB110	88	(S)				
	EB111.CS	108	(M)				
	EB112.CS	168	(L)				
35,8–40,5	EB110	88	(S)				
	EB111.CS	108	(M)				
	EB112.CS	168	(L)				
39,8–45,5	EB110	88	(S)				
	EB111.CS	108	(M)				
	EB112.CS	168	(L)				

EB...CS = Solid carbide shank

Advantages: Increased rigidity, reduced deflection, neutralised vibration

Assembly parts

		Designation	Tightening torque
	Clamping screw	FS 1085 (SW 5)	10 Nm
	Clamping screw for extension	FS 1112 (SW 5)	14 Nm
	Clamping screw for insert	FS 1454 (Torx 8IP)	1,2 Nm
	Clamping screw for balancing rings	FS 2038 (SW 2)	

★ New addition to range



Insert holder

Complete tool

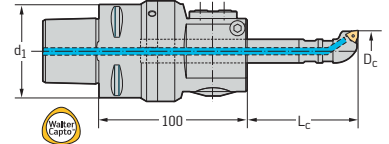
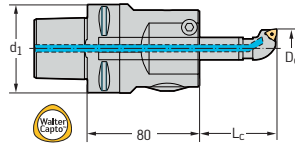

Designation	l_{12} mm	Type	L_c min mm	L_c max mm	kg	Complete tool Designation	Complete tool balanceable Designation
EB308.WC04	27	WC...0402...	55	80	1,8	★ B3230.C6.18-22.Z1.WC04.S	★ B4030.C6.18-22.Z1.WC04.S
			75	100	2,0	★ B3230.C6.18-22.Z1.WC04.M	★ B4030.C6.18-22.Z1.WC04.M
			135	160	2,2	★ B3230.C6.18-22.Z1.WC04.L	★ B4030.C6.18-22.Z1.WC04.L
EB309.WC04	27	WC...0402...	55	80	2,3	★ B3230.C6.22-25.Z1.WC04.S	★ B4030.C6.22-25.Z1.WC04.S
			75	100	2,5	★ B3230.C6.22-25.Z1.WC04.M	★ B4030.C6.22-25.Z1.WC04.M
			135	160	2,7	★ B3230.C6.22-25.Z1.WC04.L	★ B4030.C6.22-25.Z1.WC04.L
EB310.WC04	27	WC...0402...	55	80	2,3	★ B3230.C6.25-28.Z1.WC04.S	★ B4030.C6.25-28.Z1.WC04.S
			75	100	2,5	★ B3230.C6.25-28.Z1.WC04.M	★ B4030.C6.25-28.Z1.WC04.M
			135	160	2,7	★ B3230.C6.25-28.Z1.WC04.L	★ B4030.C6.25-28.Z1.WC04.L
EB311.WC04	27	WC...0402...	55	80	2,3	★ B3230.C6.28-32.Z1.WC04.S	★ B4030.C6.28-32.Z1.WC04.S
			75	100	2,5	★ B3230.C6.28-32.Z1.WC04.M	★ B4030.C6.28-32.Z1.WC04.M
			135	160	2,7	★ B3230.C6.28-32.Z1.WC04.L	★ B4030.C6.28-32.Z1.WC04.L
EB312.WC04	27	WC...0402...	55	80	2,3	★ B3230.C6.32-36.Z1.WC04.S	★ B4030.C6.32-36.Z1.WC04.S
			75	100	2,5	★ B3230.C6.32-36.Z1.WC04.M	★ B4030.C6.32-36.Z1.WC04.M
			135	160	2,7	★ B3230.C6.32-36.Z1.WC04.L	★ B4030.C6.32-36.Z1.WC04.L
EB313.WC04	27	WC...0402...	55	80	2,3	★ B3230.C6.36-40.Z1.WC04.S	★ B4030.C6.36-40.Z1.WC04.S
			75	100	2,5	★ B3230.C6.36-40.Z1.WC04.M	★ B4030.C6.36-40.Z1.WC04.M
			135	160	2,7	★ B3230.C6.36-40.Z1.WC04.L	★ B4030.C6.36-40.Z1.WC04.L
EB314.WC04	27	WC...0402...	55	80	2,3	★ B3230.C6.40-45.Z1.WC04.S	★ B4030.C6.40-45.Z1.WC04.S
			75	100	2,5	★ B3230.C6.40-45.Z1.WC04.M	★ B4030.C6.40-45.Z1.WC04.M
			135	160	2,7	★ B3230.C6.40-45.Z1.WC04.L	★ B4030.C6.40-45.Z1.WC04.L

For assembly aids, see page G 105 of the Walter General catalogue 2012.
Bodies and assembly parts are included in the scope of delivery.

Accessories



Screwdriver

FS 1483 (Torx 8IP)



Allen key DIN 911

SW 5

Torque screwdriver with interchangeable blades, see page H-2.



C-27



G-2



C 188*



C-86

★ New addition to range

Boring bar EB . . .

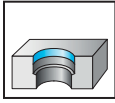
 $\kappa = 93^\circ$

Tool		Designation	D_c min mm	d_5 mm	f mm	l_1 mm	l_5 mm	L_c mm	λ	Type	
One-piece 	EB301 WK10		2,0	4	1,0	30	21			VHM WK 10	
	EB302 WK10		3,0	4	1,5	35	21				
One-piece 	EB513		5,8	16				17		WC . . 0201 . .	
	EB514.CS		5,8	16				30			
	EB515		7,3	16				21			
	with insert holder 	EB516.CS		7,3	16				36		WC . . 0302 . .
		EB517		8,8	16				28		
		EB518.CS		8,8	16				47		
		EB519		11,8	16				35		
		EB520.CS		11,8	16				60		
		EB521		13,8	16				42		
		EB522.CS		13,8	16				72		
with insert holder 	EB303.WC02.CS		5,8	5	2,9	85	70			WC . . 0201 . .	
	EB304.WC02.CS		7,3	6	3,65	95	75				
	EB353.WC03		8,8	8	4,5	65	47		-10°	WC . . 0302 . .	
	EB354.WC03.CS		8,8	8	4,5	105	87		-10°		
	EB355.WC03		11,8	10	6,0	75	52		-7°		
	EB356.WC03.CS		11,8	10	6,0	120	97		-7°		
	EB357.WC03		13,8	10	6,9	75	52		-5°		
	EB358.WC03.CS		13,8	10	6,9	120	97		-5°		
	EB359.WC04		17,8	16	8,9	115	88		-3°		
	EB360.WC04.CS		17,8	16	8,9	135	108		-3°		
	EB361.WC04.CS		17,8	16	8,9	195	168		-3°		
	EB362.WC04		21,8	16	10,9	115	88		-2,5°		
	EB363.WC04.CS		21,8	16	10,9	135	108		-2,5°		
	EB364.WC04.CS		21,8	16	10,9	195	168		-2,5°		
	EB365.WC04		24,8	16	12,4	115	88		0°		
	EB366.WC04.CS		24,8	16	12,4	135	108		0°		
	EB367.WC04.CS		24,8	16	12,4	195	168		0°		
	EB368.WC04		27,8	16	13,9	115	88		0°		
	EB369.WC04.CS		27,8	16	13,9	135	108		0°		
	EB370.WC04.CS		27,8	16	13,9	195	168		0°		
	EB371.WC04		31,8	16	15,9	115	88		0°		
	EB372.WC04.CS		31,8	16	15,9	135	108		0°		
	EB373.WC04.CS		31,8	16	15,9	195	168		0°		
	EB374.WC04		35,8	16	17,9	115	88		0°		
	EB375.WC04.CS		35,8	16	17,9	135	108		0°		
	EB376.WC04.CS		35,8	16	17,9	195	168		0°		
	EB377.WC04		39,8	16	19,9	115	88		0°		
	EB378.WC04.CS		39,8	16	19,9	135	108		0°		
	EB379.WC04.CS		39,8	16	19,9	195	168		0°		

Bodies and assembly parts are included in the scope of delivery.



Assembly parts			Accessories		
Toolholder	Insert holder	Clamping screw for indexable insert	Tightening torque	Screwdriver	
		FS 2245 (Torx 6IP)	0,6 Nm	FS 2086 (Torx 6IP)	
		FS 2084 (Torx 7IP)	0,9 Nm	FS 2088 (Torx 7IP)	
—	EB303.WC02.CS	FS 2245 (Torx 6IP)	0,6 Nm	FS 2086 (Torx 6IP)	
—	EB304.WC02.CS				
EB106	EB305.WC03	FS 2084 (Torx 7IP)	0,9 Nm	FS 2088 (Torx 7IP)	
EB107.CS	EB305.WC03				
EB108	EB306.WC03				
EB109.CS	EB306.WC03				
EB108	EB307.WC03				
EB109.CS	EB307.WC03				
EB110	EB308.WC04	FS 1454 (Torx 8IP)	1,2 Nm	FS 1483 (Torx 8IP)	
EB111.CS	EB308.WC04				
EB112.CS	EB308.WC04				
EB110	EB309.WC04				
EB111.CS	EB309.WC04				
EB112.CS	EB309.WC04				
EB110	EB310.WC04				
EB111.CS	EB310.WC04				
EB112.CS	EB310.WC04				
EB110	EB311.WC04				
EB111.CS	EB311.WC04				
EB112.CS	EB311.WC04				
EB110	EB312.WC04				
EB111.CS	EB312.WC04				
EB112.CS	EB312.WC04				
EB110	EB313.WC04				
EB111.CS	EB313.WC04				
EB112.CS	EB313.WC04				
EB110	EB314.WC04				
EB111.CS	EB314.WC04				
EB112.CS	EB314.WC04				

EB ... CS = Solid carbide shank
 Advantages: Increased rigidity, reduced deflection, neutralised vibration



Precision boring tool B 3230

Walter Precision^{MEDIUM}

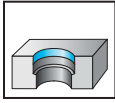



- Ø 15–33 mm
- $\kappa = 95^\circ / \kappa = 93^\circ$
- $Z = 1$
- * Reverse machining possible

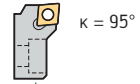
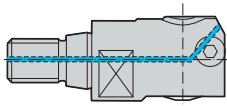

Basic body

Cartridge with C insert

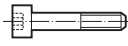

Tool	Basic body Designation	d ₁ mm	D _c mm	Cartridge No.	Designation	 Type
NCT ScrewFit 	B3230G.T14.15–21.Z1	T14	15–18,5	1		
			18–21,5	2		
	B3230G.T18.20–26.Z1	T18	20–26	1	EB321.CP05	CP . . 0502 . .
	B3230G.T22.26–33.Z1	T22	26–33	1	EB323.CP05	CP . . 0502 . .

For assembly aids, see page G 105 of the Walter General catalogue.
Bodies and assembly parts are included in the scope of delivery.

Assembly parts	T14	T18	T22	
	15–21,5	for D _c min–max [mm]		
	15–21,5	20–26	26–33	
	Clamping screw	FS 2244 (SW 1,5)	FS 2251 (Torx 9IP)	FS 1082 (SW 2,5)
	Tightening torque			2,0 Nm
	Clamping screw for cartridge	FS 1457 (Torx 9IP)	FS 2080 (Torx 15IP)	FS 1495 (Torx 20IP)
	Tightening torque	0,9 Nm	2,0 Nm	2,5 Nm
	Clamping screw for insert	FS 2245 (Torx 6IP)	FS 2084 (Torx 7IP)	
	Tightening torque	0,6 Nm	0,8 Nm	



Cartridge with W insert

Complete tool

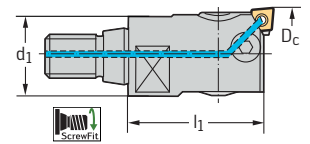
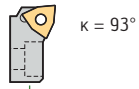

Designation	Type	d ₁ mm	l ₁ mm	kg	Complete tool Designation with C insert	Complete tool Designation with W insert
EB549.WC02	WC . . 0201 . .	14	30	0,10		B3230.T14.15-18.Z1.WC02
EB550.WC02	WC . . 0201 . .	18	30	0,10		B3230.T14.18-21.Z1.WC02
EB341.WC03	WC . . 0302 . .	22	35	0,10	B3230.T18.20-26.Z1.CP05	B3230.T18.20-26.Z1.WC03
EB343.WC03	WC . . 0302 . .	26	40	0,15	B3230.T22.26-33.Z1.CP05	B3230.T22.26-33.Z1.WC03

Accessories		T14	T18	T22
		15–21,5	for D _C min–max [mm]	
		20–26	26–33	
	Screwdriver for clamping screw	FS 2086 (Torx 6IP)	FS 2088 (Torx 7IP)	
	Torx key for clamping screw	FS 1484 (Torx 9IP)		
	Wrench DIN 911 for clamping screw	SW 1,5		SW 2,5
	Wrench for cartridge clamping	FS 1484 (Torx 9IP)	FS 1486 (Torx 20IP)	FS 1485 (Torx 15IP)

Torque screwdriver with interchangeable blades, see page H-2.



Precision boring tool

B 3230

Walter Precision^{MEDIUM}

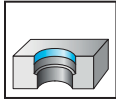

- Ø 20–203 mm
- $\kappa = 95^\circ / \kappa = 93^\circ$
- Z = 1
- * Reverse machining possible

Basic body

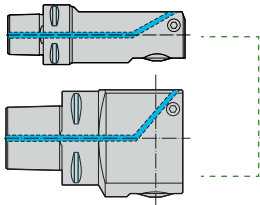

Cartridge with C and W insert

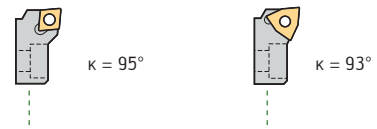

Tool	Basic body Designation	d ₁ mm	D _c mm	Cartridge No.	Designation	Type		
						Type	Type	
Walter Capto™	★ B3230G.C3.20–38.Z1	C3	20–26,5	1	EB321.CP05	CP . . 0502 . .	EB341.WC03	WC . . 0302 . .
			(28) ¹ 26–32,5*	2	EB523.CP05		EB536.WC03	
			32–38,5*	3	EB524.CP05		EB537.WC03	
	★ B3230G.C3.26–47.Z1	C3	26–33,5	1	EB323.CP05	CP . . 0502 . .	EB343.WC03	WC . . 0302 . .
			(34) ¹ 33–40,5*	2	EB525.CP05		EB538.WC03	
			40–47,5*	3	EB526.CP05		EB539.WC03	
	★ B3230G.C3.33–57.Z1	C3	33–41,5	1	EB325.CP05	CP . . 0502 . .	EB345.WC03	WC . . 0302 . .
			41–49,5*	2	EB527.CP05		EB540.WC03	
			49–57,5*	3	EB528.CP05		EB541.WC03	
	★ B3230G.C4.41–83.Z1	C4	41–55,5	1	EB327.CC06	CC . . 0602 . .	EB347.WC04	WC . . 0402 . .
			55–69,5*	2	EB532.CC06		EB545.WC05	
			69–83,5*	3	EB533.CC06		EB546.WC05	WC . . 0503 . .
	★ B3230G.C5.55–100.Z1	C5	55–70,5	1	EB329.CC06	CC . . 0602 . .	EB349.WC05	WC . . 0503 . .
			70–85,5*	2	EB534.CC06		EB547.WC05	
			85–100,5*	3	EB535.CC06		EB548.WC05	
	★ B3230G.C6.070–120.Z1	C6	70–90,5	1	EB329.CC06	CC . . 0602 . .	EB349.WC05	WC . . 0503 . .
			85–105,5*	2	EB534.CC06		EB547.WC05	
			100–120,5*	3	EB535.CC06		EB548.WC05	
	★ B3230G.C6.090–166.Z1	C6	90–116*	1	EB529.CC06	CC . . 0602 . .	EB542.WC05	WC . . 0503 . .
			115–141*	2	EB530.CC06		EB543.WC05	
			140–166*	3	EB531.CC06		EB544.WC05	
	★ B3230G.C8.090–166.Z1	C8	90–116*	1	EB529.CC06	CC . . 0602 . .	EB542.WC05	WC . . 0503 . .
			115–141*	2	EB530.CC06		EB543.WC05	
			140–166*	3	EB531.CC06		EB544.WC05	
	★ B3230G.C6.110–203.Z1	C6	110–153*	1	EB529.CC06	CC . . 0602 . .	EB542.WC05	WC . . 0503 . .
			135–178*	2	EB530.CC06		EB543.WC05	
			160–203*	3	EB531.CC06		EB544.WC05	
	★ B3230G.C8.110–203.Z1	C8	110–153*	1	EB529.CC06	CC . . 0602 . .	EB542.WC05	WC . . 0503 . .
			135–178*	2	EB530.CC06		EB543.WC05	
			160–203*	3	EB531.CC06		EB544.WC05	

¹ D_{min} for reverse machining.

* Reverse machining possible.

For assembly aids, see page G 28 of the Walter General catalogue 2012.

Bodies and assembly parts are included in the scope of delivery.

Assembly parts		for D _c min–max [mm]							
		C3	C4	C5	C6	C6 / C8			
	Clamping screw	FS 2251 (Torx 9IP)	FS 1082 (SW 3)	FS 1082 (SW 2,5)	FS 1083 (SW 3)	FS 1085 (SW 5)	FS 1086 (SW 6)	FS 1087 (SW 6)	
	Tightening torque		2,5 Nm	2,0 Nm	2,5 Nm	10,0 Nm	25,0 Nm	25,0 Nm	
	Clamping screw for cartridge	FS 1457 (Torx 9IP)	FS 2080 (Torx 15IP)	FS 1495 (Torx 20IP)	FS 1091 (SW 3)	FS 1092 (SW 5)	FS 1092 (SW 5)	FS 2150 (Torx 30IP)	
	Tightening torque	1,5 Nm	2,5 Nm	5,0 Nm	2,5 Nm	12,0 Nm	12,0 Nm	10,0 Nm	
	Clamping screw for insert	for CP . . 05 / WC . . 03 = FS 2084 (Torx 7IP)			for CC . . 06 / WC . . 04 = FS 1454 (Torx 8IP)				
	Tightening torque	0,8 Nm			for WC . . 05 = FS 1457 (Torx 9IP)				
					FS 1454 = 0,8 Nm / FS 1457 = 1,5 Nm				

★ New addition to range



Complete tool

Precision set

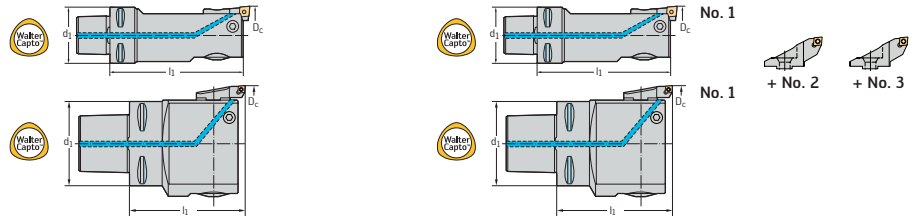

	d ₁ mm	l ₁ mm	kg	Complete tool Designation with C insert	Complete tool Designation with W insert	Precision set Designation with C insert	Precision set Designation with W insert
	32	80	0,23	★ B3230.C3.020-026.Z1.CP05	★ B3230.C3.020-026.Z1.WC03		
			0,23	★ B3230.C3.026-032.Z1.CP05	★ B3230.C3.026-032.Z1.WC03	★ B3230.C3.020-038.Z1.CP05	★ B3230.C3.020-038.Z1.WC03
			0,24	★ B3230.C3.032-038.Z1.CP05	★ B3230.C3.032-038.Z1.WC03		
	32	80	0,29	★ B3230.C3.026-033.Z1.CP05	★ B3230.C3.026-033.Z1.WC03		
			0,30	★ B3230.C3.033-040.Z1.CP05	★ B3230.C3.033-040.Z1.WC03	★ B3230.C3.026-047.Z1.CP05	★ B3230.C3.026-047.Z1.WC03
			0,30	★ B3230.C3.040-047.Z1.CP05	★ B3230.C3.040-047.Z1.WC03		
	32	80	0,42	★ B3230.C3.033-041.Z1.CP05	★ B3230.C3.033-041.Z1.WC03		
			0,42	★ B3230.C3.041-049.Z1.CP05	★ B3230.C3.041-049.Z1.WC03	★ B3230.C3.033-057.Z1.CP05	★ B3230.C3.033-057.Z1.WC03
			0,42	★ B3230.C3.049-057.Z1.CP05	★ B3230.C3.049-057.Z1.WC03		
	40	80	0,7	★ B3230.C4.041-055.Z1.CC06	★ B3230.C4.041-055.Z1.WC04		
			0,7	★ B3230.C4.055-069.Z1.CC06	★ B3230.C4.055-069.Z1.WC05	★ B3230.C4.041-083.Z1.CC06	★ B3230.C4.041-083.Z1.WC04
			0,7	★ B3230.C4.069-083.Z1.CC06	★ B3230.C4.069-083.Z1.WC05		
	50	100	1,4	★ B3230.C5.055-070.Z1.CC06	★ B3230.C5.055-070.Z1.WC05		
			1,4	★ B3230.C5.070-085.Z1.CC06	★ B3230.C5.070-085.Z1.WC05	★ B3230.C5.055-100.Z1.CC06	★ B3230.C5.055-100.Z1.WC05
			1,4	★ B3230.C5.085-100.Z1.CC06	★ B3230.C5.085-100.Z1.WC05		
	63	100	2,1	★ B3230.C6.070-090.Z1.CC06	★ B3230.C6.070-090.Z1.WC05		
			2,2	★ B3230.C6.085-105.Z1.CC06	★ B3230.C6.085-105.Z1.WC05	★ B3230.C6.070-120.Z1.CC06	★ B3230.C6.070-120.Z1.WC05
			2,1	★ B3230.C6.100-120.Z1.CC06	★ B3230.C6.100-120.Z1.WC05		
	63	110	3,2	★ B3230.C6.090-116.Z1.CC06	★ B3230.C6.090-116.Z1.WC05		
			3,2	★ B3230.C6.115-141.Z1.CC06	★ B3230.C6.115-141.Z1.WC05	★ B3230.C6.090-166.Z1.CC06	★ B3230.C6.090-166.Z1.WC05
			3,2	★ B3230.C6.140-166.Z1.CC06	★ B3230.C6.140-166.Z1.WC05		
	80	110	4,0	★ B3230.C8.090-116.Z1.CC06	★ B3230.C8.090-116.Z1.WC05		
			4,0	★ B3230.C8.115-141.Z1.CC06	★ B3230.C8.115-141.Z1.WC05	★ B3230.C8.090-166.Z1.CC06	★ B3230.C8.090-166.Z1.WC05
			4,0	★ B3230.C8.140-166.Z1.CC06	★ B3230.C8.140-166.Z1.WC05		
	63	110	4,1	★ B3230.C6.110-153.Z1.CC06	★ B3230.C6.110-153.Z1.WC05		
			4,1	★ B3230.C6.135-178.Z1.CC06	★ B3230.C6.135-178.Z1.WC05	★ B3230.C6.110-203.Z1.CC06	★ B3230.C6.110-203.Z1.WC05
			4,1	★ B3230.C6.160-203.Z1.CC06	★ B3230.C6.160-203.Z1.WC05		
	63	110	4,8	★ B3230.C8.110-153.Z1.CC06	★ B3230.C8.110-153.Z1.WC05		
			4,8	★ B3230.C8.135-178.Z1.CC06	★ B3230.C8.135-178.Z1.WC05	★ B3230.C8.110-203.Z1.CC06	★ B3230.C8.110-203.Z1.WC05
			4,8	★ B3230.C8.160-203.Z1.CC06	★ B3230.C8.160-203.Z1.WC05		

Accessories	C3		C4	C5	C6	C6 / C8			
	for D _c min-max [mm]								
	20-38,5	26-47,5	33-57,5	41-83,5	55-100,5	70-120,5	90-203		
	Screwdriver for clamping screw		FS 2088 (Torx 7IP)	for CC . . 06 / WC . . 04 = FS 1483 (Torx 8IP) for WC . . 05 = FS 1484 (Torx 9IP)					
	Screwdriver for clamping screw		FS 1484 (Torx 9IP)						
	Wrench DIN 911 for clamping screw			SW 2,5	SW 3	SW 4	SW 5	SW 6	SW 6
	Wrench for cartridge clamping		FS 1484 (Torx 9IP)	FS 1485 (Torx 15IP)	FS 1486 (Torx 20IP)				FS 2108 (Torx 30IP)
	Allen key DIN 911 for cartridge clamping					SW 3	SW 5	SW 5	



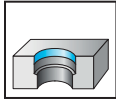

★ New addition to range

Self-balancing precision boring tool B 4030

Walter Precision^{MEDIUM}

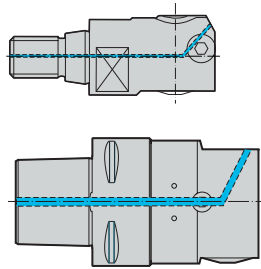
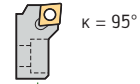



- Ø 33–153 mm
- $\kappa = 95^\circ / \kappa = 93^\circ$
- Z = 1

Basic body

Cartridge with C insert

Tool	Basic body Designation	d ₁ mm	D _c mm	Designation	Type
NCT ScrewFit 	B4030G.T28.33–41.Z1	T 28	33–41	EB323.CP 05	CP .. 0502 ..
	B4030G.T36.41–55.Z1	T 36	41–55	EB325.CP05	CP .. 0502 ..
	B4030G.T45.55–70.Z1	T 45	55–70	EB327.CC06	CC .. 0602 ..
Walter Capto™ 	★ B4030G.C6.070–090.Z1	C6	70–90	EB327.CC06	CC .. 0602 ..
	★ B4030G.C8.090–110.Z1*	C8	90–110		
	★ B4030G.C8.110–153.Z1*	C8	110–153		

*Aluminium design

For assembly aids, see page G 105 of the Walter General catalogue 2012.
Bodies and assembly parts are included in the scope of delivery.

Assembly parts	D _c min–max [mm]						
	33–41	41–55	55–70	70–90	90–110	110–153	
	Clamping screw	FS 2031 (SW 2,5)	FS 2032 (SW 3)	FS 2033 (SW 4)	FS 2034 (SW 5)	FS 2035 (SW 6)	FS 2036 (SW 6)
	Tightening torque	2,5 Nm	3,0 Nm	6,0 Nm	12 Nm	15 Nm	15 Nm
	Clamping screw for cartridge	FS 2080 (Torx 15IP)	FS 1495 (Torx 20IP)	FS 1091 (SW 3)			
	Tightening torque	2,5 Nm	2,5 Nm	2,5 Nm			
	Clamping screw for insert	FS 2084 (Torx 7IP)		FS 1454 (Torx 8IP)			
	Tightening torque	0,8 Nm		0,8 Nm			

★ New addition to range



Cartridge with W insert

Complete tool

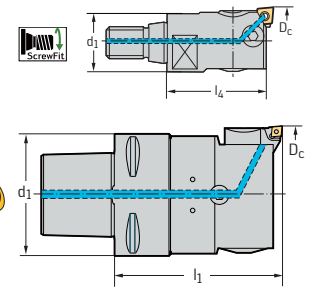
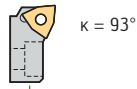

Designation	Type	d ₁ mm	l ₁ mm	kg	Complete tool balanceable Designation with C insert	Complete tool balanceable Designation with W insert
EB343.WC03	WC . . 0302 . .	28	55	0,3	B4030.T28.33-41.Z1.CP05	B4030.T28.33-41.Z1.WC03
EB345.WC03	WC . . 0302 . .	36	65	0,6	B4030.T36.41-55.Z1.CP05	B4030.T36.41-55.Z1.WC03
EB347.WC04	WC . . 0402 . .	45	80	1,0	B4030.T45.55-70.Z1.CC06	B4030.T45.55-70.Z1.WC04
EB347.WC04	WC . . 0402 . .	63	100	2,5	★ B4030.C6.070-090.Z1.CC06	★ B4030.C6.070-090.Z1.WC04
		80	110	1,6	★ B4030.C8.090-110.Z1.CC06	★ B4030.C8.090-110.Z1.WC04
		80	110	2,0	★ B4030.C8.110-153.Z1.CC06	★ B4030.C8.110-153.Z1.WC04

Accessories		for D _c min-max [mm]				
		33-41	41-55	55-70	70-90	90-153
	Screwdriver for clamping screw	FS 1484 (Torx 7IP)		FS 1483 (Torx 8IP)		
	Wrench DIN 911 for clamping screw	SW 2,5	SW 3	SW 4	SW 5	SW 6
	Wrench for cartridge clamping	FS 1485 (Torx 15IP)	FS 1486 (Torx 20IP)			
	Allen key DIN 911 for cartridge clamping			SW 3		

Torque screwdriver with interchangeable blades, see page H-2.



★ New addition to range

Precision boring tool with bridge B 3230

Walter Precision^{MAXI}

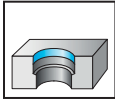

- Ø 150–640 mm
- $\kappa = 95^\circ / \kappa = 93^\circ$
- $Z = 1$
- Aluminium bridge

Basic body



Tool	Basic body Designation	d ₁ mm	D _c mm	Bridge	Balance weight	Cartridge holder
Walter Capto™ 	★ B3223G.C8.150–640	C8	150–220	★ EB134AL	—	—
			220–290	★ EB135AL	EB121	EB123
			290–360	★ EB136AL		
			360–430	★ EB137AL		
			430–500	★ EB138AL		
			500–570	★ EB139AL		
			570–640	★ EB140AL		

For assembly aids, see page G 105 of the Walter General catalogue 2012.
Bodies and assembly parts are included in the scope of delivery.

Assembly parts

	Designation	Tightening torque
	FS 1114 (SW 10)	120 Nm
	FS 1086 (SW 6)	25 Nm
	FS 1113 (SW 6)	25 Nm
	FS 1092 (SW 5)	12 Nm
	FS 1457 (Torx 9IP)	2,5 Nm

★ New addition to range



Cartridge with C insert

Cartridge with W insert

Complete tool

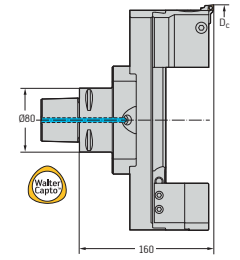

Cartridge designation	Type	Cartridge designation	Type	kg	Complete tool Designation with C insert	Complete tool Designation with W insert
EB329.CC06	CCGT 06 . .	EB349.WC05	WCGT 05 . .	6,3	★ B3230.C8.150-220.Z1.CC06	★ B3230.C8.150-220.Z1.WC05
				6,8	★ B3230.C8.220-290.Z1.CC06	★ B3230.C8.220-290.Z1.WC05
				7,2	★ B3230.C8.290-360.Z1.CC06	★ B3230.C8.290-360.Z1.WC05
				7,5	★ B3230.C8.360-430.Z1.CC06	★ B3230.C8.360-430.Z1.WC05
				7,9	★ B3230.C8.430-500.Z1.CC06	★ B3230.C8.430-500.Z1.WC05
				8,2	★ B3230.C8.500-570.Z1.CC06	★ B3230.C8.500-570.Z1.WC05
				8,4	★ B3230.C8.570-640.Z1.CC06	★ B3230.C8.570-640.Z1.WC05

Accessories

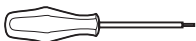

Screwdriver for clamping screw

FS 1484 (Torx 9IP)



Allen key DIN 911

SW 5 / SW 6 / SW 10

Torque screwdriver with interchangeable blades, see page H-2.



★ New addition to range

Precision boring tool with bridge B 3234

Walter Precision^{MAXI}

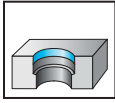

- Ø 150–640 mm
- $\kappa = 95^\circ / \kappa = 93^\circ$
- $Z = 1$
- Cutting edge orientation rotated by 90° in relation to B3230G.C ...
- Aluminium bridge

Basic body

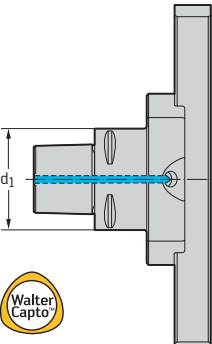

Tool	Basic body Designation	d_1 mm	D_c mm	Bridge	Balance weight	Cartridge holder
Walter Capto™ 	 ★ B3224G.C8.150–640	C8	150–220	★ EB134AL	—	—
			220–290	★ EB135AL	EB121	EB123
			290–360	★ EB136AL		
			360–430	★ EB137AL		
			430–500	★ EB138AL		
			500–570	★ EB139AL		
			570–640	★ EB140AL		

For assembly aids, see page G 105 of the Walter General catalogue.
Bodies and assembly parts are included in the scope of delivery.

Assembly parts

		Designation	Tightening torque
	Clamping screw for bridge	FS 1114 (SW 10)	120 Nm
	Clamping screw for balance weight slide	FS 1086 (SW 6)	25 Nm
	Clamping screw for cartridge holder and balance weight	FS 1113 (SW 6)	25 Nm
	Clamping screw for cartridge	FS 1092 (SW 5)	12 Nm
	Clamping screw for insert	FS 1457 (Torx 9IP)	2,5 Nm

★ New addition to range



Cartridge with C insert

Cartridge with W insert

Complete tool

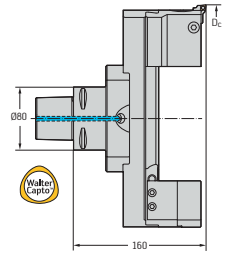

Cartridge Designation	Type	Cartridge Designation	Type	kg	Complete tool Designation with C insert	Complete tool Designation with W insert
EB329.CC06	CCGT 06 ..	EB349.WC05	WCGT 05 ..	6,3	★ B3234.C8.150-220.Z1.CC06	★ B3234.C8.150-220.Z1.WC05
				6,8	★ B3234.C8.220-290.Z1.CC06	★ B3234.C8.220-290.Z1.WC05
				7,2	★ B3234.C8.290-360.Z1.CC06	★ B3234.C8.290-360.Z1.WC05
				7,5	★ B3234.C8.360-430.Z1.CC06	★ B3234.C8.360-430.Z1.WC05
				7,9	★ B3234.C8.430-500.Z1.CC06	★ B3234.C8.430-500.Z1.WC05
				8,2	★ B3234.C8.500-570.Z1.CC06	★ B3234.C8.500-570.Z1.WC05
				8,4	★ B3234.C8.570-640.Z1.CC06	★ B3234.C8.570-640.Z1.WC05

Accessories

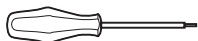

Screwdriver for clamping screw

FS 1484 (Torx 9IP)



Allen key DIN 911

SW 5 / SW 6 / SW 10

Torque screwdriver with interchangeable blades, see page H-2.



★ New addition to range

Precision boring tool sets

B 4035

Walter Precision^{DIGITAL}

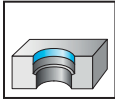

- Ø 10–124 mm
- κ = 93°
- Z = 1

Tool	D _c mm	Set Designation	d ₁	Set contents Toolholder	Designation
	10–32	★ B4035 Set 1	C6	Boring bar	EB611.WC03 EB615.WC03 EB619.WC03
				Extension	EB642
				Basic body	B4035 basic body
	32–68	★ B4035 Set 2	C6	Extension	EB625 EB627
				Basic body	B4035 basic body
	68–124	★ B4035 Set 3	C6	Bridge	EB631 EB632
				Counterweight	EB635
				Basic body	B4035 basic body

Bodies and assembly parts are included in the scope of delivery.

Assembly parts		Designation	Tightening torque
	Clamping screw for insert	FS 2084 (IP 7) for WC . . 0302 . . FS 1454 (IP 8) for WC . . 0402 . .	0,9 Nm 0,9 Nm
	Clamping screw for basic body	FS 2101 (SW 4)	8,0 Nm
	Clamping grub screw for boring bar	FS 2102 (SW 4)	8,0 Nm
	Screwdriver	FS 2088 (IP 7) for FS 2084 FS 1483 (IP 8) for FS 1454	
	Coolant supply adaptor	EB636	
	Battery	FS 2122	
	Battery compartment gasket	FS 2121	
	Battery compartment cover	FS 2123	

★ New addition to range



Insert holder	Designation	D _c opt.* mm	D _c mm	L _c mm	 Type
		10–11	10–17	27	WC...0302..
		14–15	14–21	47	
		18–19	18–25	65	
Cartridge	EB644.WC04	20–22	20–24	81	WC...0402..
	EB621.WC04	24–26	24–28	81	
	EB623.WC04	28–30	28–32	81	
Cartridge	EB629.WC04		32–41	63	WC...0402..
	EB630.WC04		41–50	63	
Cartridge	EB629.WC04		50–59	72	
	EB630.WC04		59–68	72	
Cartridge	EB634.WC04		68–96	32,5	WC...0402..
	EB634.WC04		96–124	32,5	

*D_c opt. = Diameter range with optimum balancing, for maximum speeds.

Accessories

	Allen key DIN 911	SW 1,5 / SW 3
	T-handle	FS 1174 (T 25)

Expansion components and individual parts B 4035

Walter Precision^{DIGITAL}

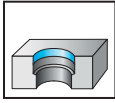

- Ø 3–20 mm

Tool	Designation	D_c opt.* mm	d_1 mm	D_c mm	d_5 mm	L_c mm	Type
Basic body							
	★ B4035 Basic set metric		C6				
One-piece insert holder	EB603.WXP15	3–4		3–10	6	10	—
	EB604.WXP15	4–5		4–11	6	10	
	EB605.WXP15	5–6		5–12	6	10	
	EB606.WXP15	5–6		5–12	6	20	
	EB607.WXP15	6–7		6–13	6	20	
	EB608.WXP15	6–7		6–13	6	30	
	EB609.WXP15	8–9		8–15	8	23	
	EB610.WXP15	8–9		8–15	8	48	
	Boring bar	EB611.WC03	10–11		10–17	17	30
	EB612.WC03	11–12		11–18	17	30	
	EB613.WC03	12–13		12–19	17	45	
	EB614.WC03	13–14		13–20	17	45	
	EB615.WC03	14–15		14–21	17	50	
	EB616.WC03	15–16		15–22	17	50	
	EB617.WC03	16–17		16–23	17	60	
	EB618.WC03	17–18		17–24	17	60	
	EB619.WC03	18–19		18–25	17	68	
	EB620.WC03	19–20		19–26	17	68	
	EB637.WC03.CS			10–12	17	55	
	EB638.WC03.CS			12–14	17	65	
	EB639.WC03.CS			14–16	17	75	
	EB640.WC03.CS			16–18	17	85	
	EB641.WC03.CS			18–20	17	95	

* D_c opt. = Tool has optimum balance → suitable for maximum speeds.

Bodies and assembly parts are included in the scope of delivery.



EB...CS = Solid carbide shank:

Advantages: Increased rigidity, reduced deflection, neutralised vibration

★ New addition to range



Set 1

Assembly parts		d ₁ = 6 mm	d ₁ = 8 mm	d ₁ = 17 mm
	Threaded plug	FS 2093 (SW 3)	FS 2093 (SW3)	
	Tightening torque	4 Nm	4 Nm	
	Clamping screw for insert			FS 2084 (Torx 7IP)
	Tightening torque			0,9 Nm

For basic bodies for assembly parts, see page C-70.

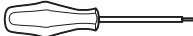
Accessories		d ₁ = 6 mm	d ₁ = 8 mm	d ₁ = 17 mm
	Adaptors	EB601	EB602	-
	Screwdriver	DIN 911 (SW 3)	DIN 911 (SW 3)	FS 2088 (Torx 7IP)

Expansion components and individual parts

B 4035

Walter Precision^{DIGITAL}

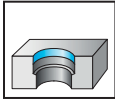

- Ø 20–124 mm

Tool	Designation	d ₁	D _{C opt.*} mm	for D _C mm	d ₁₁ mm	L ₄ mm	Type
Basic body 	★ B4035 Basic Set metric	C6					
Cartridges 	EB644.WC04		20–22	20–24		12	WC...0402...
	EB645.WC04		22–24	22–26		12	
	EB621.WC04		24–26	24–28		12	
	EB622.WC04		26–28	26–30		12	
	EB623.WC04		28–30	28–32		12	
	EB624.WC04		30–32	30–34		12	
	EB629.WC04			32–41 ¹ 50–59 ²		14	
	EB630.WC04			41–50 ¹ 59–68 ²		14	
	EB634.WC04			68–124		16,5	
Extension 	EB642			20–32	25	72	—
	EB643.CS			20–32	—	108	
	EB625			32–50	28,5	52	
	EB626			32–50	28,5	88	
	EB627			50–68	46	61	
	EB628			50–68	46	106	
Bridge 	EB631			68–96		16	
	EB632			96–124		16	
	EB635 (counterweight)						

*D_{C opt.} = Tool has optimum balance → suitable for maximum speeds.

¹ = In combination with EB625 / EB626

² = In combination with EB627 / EB628

Bodies and assembly parts are included in the scope of delivery.

EB...CS = Solid carbide shank:

Advantages: Increased rigidity, reduced deflection, neutralised vibration.

★ New addition to range



Assembly parts

		D _c = 20–32 mm	D _c = 32–68 mm	D _c = 68–124 mm
	Clamping screw for insert	FS 1454 (Torx 8IP)		
	Tightening torque	0,9 Nm		
	Clamping screw for cartridge	FS 2094 (T 25)	FS 2096 (SW 4)	
	Tightening torque	8,0 Nm	8,0 Nm	
	Clamping bolt for extension		FS 2095	
	Clamping screw for bridge			FS 2100 (SW 4)
	Tightening torque			8,0 Nm
	Clamping screw for cartridge/counterweight			FS 2097 (SW 4)
	Tightening torque			8,0 Nm
	Threaded plug for coolant			FS 2098 (SW 1,5)
	Gasket for bridge			FS 2099

For basic bodies for assembly parts, see page C-70.

Accessories

	Screwdriver for indexable insert	FS 1483 (Torx 8IP)
	Screwdriver for extension	FS 1174 (T 25)
	Allen key DIN 911	SW 1,5 / SW 4
	Coolant supply adaptor for bridge	EB636

Cutting data for drilling with Xtra-tec® Point Drill D_c 12–38 mm

Material group	Structure of main material groups and code letters		Brinell hardness HB	Tensile strength R _m N/mm ²	Machining group ¹		Insert geometry					
							Starting values for feed f [mm/U]					
							P6001					
							D _c [mm]					
							12,0–15,9	16,0–21,9	22,0–31,99	32,0–37,99		
P	Non-alloyed steel	C ≤ 0.25%	annealed	125	428	P1	●●	0,2	0,25	0,3	0,4	
		C > 0.25 ... ≤ 0.55%	annealed	190	639	P2	●●	0,2	0,25	0,3	0,4	
		C > 0.25 ... ≤ 0.55%	tempered	210	708	P3	●●	0,2	0,25	0,3	0,4	
		C > 0.55%	annealed	190	639	P4	●●	0,2	0,25	0,3	0,4	
		C > 0.55%	tempered	300	1013	P5	●●	0,15	0,2	0,22	0,25	
		machining steel (short-chipping)	annealed	220	745	P6	●● ●	0,18	0,22	0,25	0,3	
	Low-alloyed steel	annealed		175	591	P7	●●	0,2	0,25	0,3	0,4	
		tempered		300	1013	P8	●●	0,2	0,25	0,3	0,4	
		tempered		380	1282	P9	●●	0,18	0,22	0,25	0,3	
		tempered		430	1477	P10	●●	0,15	0,2	0,22	0,28	
	High-alloyed steel and high-alloyed tool steel	annealed		200	675	P11	●●	0,15	0,2	0,22	0,28	
		hardened and tempered		300	1013	P12	●●	0,12	0,15	0,2	0,25	
		hardened and tempered		400	1361	P13	●●	0,1	0,12	0,8	0,22	
	Stainless steel	ferritic/martensitic, annealed		200	675	P14	●●	0,15	0,2	0,22	0,25	
		martensitic, tempered		330	1114	P15	●●	0,12	0,15	0,2	0,22	
M	Stainless steel	austenitic, quench hardened	200	675	M1	●●						
		austenitic, precipitation hardened (PH)	300	1013	M2							
		austenitic/ferritic, duplex	230	778	M3	●●						
K	Malleable cast iron	ferritic	200	675	K1	●● ●	0,2	0,25	0,3	0,4		
		pearlitic	260	867	K2	●● ●	0,2	0,25	0,3	0,4		
	Grey cast iron	low tensile strength	180	602	K3	●● ●	0,2	0,25	0,4	0,5		
		high tensile strength/austenitic	245	825	K4	●● ●	0,2	0,25	0,4	0,5		
	Cast iron with spheroidal graphite	ferritic	155	518	K5	●● ●	0,2	0,25	0,35	0,4		
		pearlitic	265	885	K6	●● ●	0,2	0,25	0,35	0,4		
	GGV (CGI)		200	675	K7	●● ●	0,18	0,2	0,25	0,3		
N	Aluminium wrought alloys	cannot be hardened	30	–	N1	●●						
		hardenable, hardened	100	343	N2	●●						
	Cast aluminium alloys	≤ 12% Si, cannot be hardened	75	260	N3	●●						
		≤ 12% Si, hardenable, hardened	90	314	N4	●●						
		> 12% Si, cannot be hardened	130	447	N5	●● ●						
	Magnesium alloys		70	250	N6	●●						
	Copper and copper alloys (bronze/brass)	non-alloyed, electrolytic copper		100	343	N7	●●					
brass, bronze, red brass		90	314	N8	●●							
Cu-alloys, short-chipping		110	382	N9	●● ●							
high-strength, Ampco		300	1013	N10								
S	Heat-resistant alloys	Fe-based	annealed	200	675	S1	●●					
			hardened	280	943	S2	●●					
		Ni or Co base	annealed	250	839	S3	●●					
			hardened	350	1177	S4	●●					
			cast	320	1076	S5	●●					
	Titanium alloys	pure titanium	200	675	S6							
		α and β alloys, hardened	375	1262	S7	●●						
	β alloys	410	1396	S8	●●							
Tungsten alloys		300	1013	S9								
Molybdenum alloys		300	1013	S10								
H	Hardened steel	hardened and tempered	50 HRC	–	H1							
		hardened and tempered	55 HRC	–	H2							
		hardened and tempered	60 HRC	–	H3							
	Hardened cast iron	hardened and tempered	55 HRC	–	H4							
O	Thermoplasts	without abrasive fillers			O1							
	Thermosetting plastics	without abrasive fillers			O2							
	Plastic, glass fibre reinforced	GFRP			O3							
	Plastic, carbon fibre reinforced	CFRP			O4							
	Plastic, aramid fibre reinforced	AFRP			O5							
	Graphite (technical)		80 Shore		O6							

¹The classification of the machining groups can be found in the Walter General catalogue 2012 from page H 8 onwards.

- Recommended application (the specified cutting data are regarded as starting values for the recommended application).
- Possible application. Limited to 2 x D_c drilling depth. MQL (minimum quantity lubrication) or compressed air is recommended.

Centring with a B4011/B4013 is recommended when using the B4017.

N.B.: A pilot hole approx. 1 x D_c with a B4011/B4013 is strictly necessary when using the B4010.

The specified cutting data are average recommended values.
For special applications, adjustment is recommended.

Insert geometry												Cutting material grades																					
Starting values for feed f [mm/U]												Starting values for cutting speed v _c [m/min]																					
P6002				P6003				P6004				HC																					
D _c [mm]				D _c [mm]				D _c [mm]				WXP45				WPP45C				WXK25				WMP35				WNN25					
12,0-15,9	16,0-21,9	22,0-31,99		12,0-15,99	16,0-21,99	22,0-31,99	32-37,99	12,0-15,9	16,0-21,9	22,0-31,99		3xD	5xD	7xD	10xD	3xD	5xD	7xD	10xD	3xD	5xD	7xD	10xD	3xD	5xD	7xD	10xD	3xD	5xD	7xD	10xD		
0,2	0,25	0,3		0,2	0,25	0,3	0,4					120	100	80	80	120	100	80	80					120	100	80	60						
0,2	0,25	0,3		0,2	0,25	0,3	0,4					120	100	80	80	120	100	80	80					120	100	80	50						
0,2	0,25	0,3		0,2	0,25	0,3	0,4					110	100	80	80	110	100	80	80					110	100	80	50						
0,2	0,25	0,3		0,2	0,25	0,3	0,4					120	100	80	80	120	100	80	80					120	100	80	50						
0,15	0,2	0,22		0,15	0,2	0,22	0,25					90	80	60	60	90	80	60	60					90	80	60	40						
0,18	0,22	0,25		0,18	0,22	0,25	0,3					100	90	80	80	100	90	80	80					100	90	80	50						
0,2	0,25	0,3		0,2	0,25	0,3	0,4					120	100	80	80	120	100	80	80					120	100	80	50						
0,2	0,25	0,3		0,2	0,25	0,3	0,4					80	70	60	60	80	70	60	60					80	70	60	30						
0,18	0,22	0,25		0,18	0,22	0,25	0,3					60	50	40	40	60	50	40	40					60	50	40	30						
0,15	0,2	0,22		0,15	0,2	0,22	0,28					60	50	40	40	60	50	40	40					60	50	40	30						
0,15	0,2	0,22		0,15	0,2	0,22	0,28					70	60	50	50	70	60	50	50					60	50	40	30						
0,12	0,15	0,2		0,12	0,15	0,2	0,25					70	60	50	50	70	60	50	50					60	50	40	30						
0,1	0,12	0,8		0,1	0,12	0,18	0,22					70	60	50	50	70	60	50	50					60	50	40	30						
0,15	0,2	0,22		0,15	0,2	0,22	0,25					70	60	50	50	70	60	50	50					60	50	40	30						
0,12	0,15	0,2		0,12	0,15	0,2	0,22					70	60	50	50	70	60	50	50					60	50	40	30						
				0,1	0,12	0,15	0,18																	70	50	40	30						
				0,08	0,1	0,12	0,15																	70	50	40	30						
0,2	0,25	0,3		0,2	0,25	0,3	0,4					120	110	100	100	120	110	100	100	120	110	100	100	100	90	70	60						
0,2	0,25	0,3		0,2	0,25	0,3	0,4					120	110	100	100	120	110	100	100	120	110	100	100	100	90	70	60						
0,2	0,25	0,4		0,2	0,25	0,4	0,5					140	130	120	110	140	130	120	110	160	150	140	120	140	130	120	90						
0,2	0,25	0,4		0,2	0,25	0,4	0,5					130	120	110	110	130	120	110	110	150	140	130	110	120	110	100	80						
0,2	0,25	0,35		0,2	0,25	0,35	0,4					120	110	100	100	120	110	100	100	120	110	100	100	110	100	90	70						
0,2	0,25	0,35		0,2	0,25	0,35	0,4					120	100	100	100	120	100	100	100	110	90	90	90	90	80	70	60						
0,18	0,2	0,25		0,18	0,2	0,25	0,3					110	90	90	90	110	90	90	90	110	90	90	90	90	80	70	60						
							0,4	0,5	0,6																		320	280					
							0,4	0,5	0,6																		320	280					
							0,25	0,3	0,35																		400	400					
							0,25	0,3	0,35																		320	320	280	260			
							0,25	0,3	0,35																		220	220	160	150			
							0,12	0,18	0,18																		240	200	160	150			
							0,12	0,18	0,18																		120	120	80	80			
							0,16	0,2	0,24																		160	120	80	80			
							0,12	0,18	0,18																		120	120	80	80			
							0,08	0,12	0,15	0,18																	30	20	20				
							0,08	0,12	0,15	0,18																	20	20	15				
							0,08	0,12	0,15	0,15																	20	20	15				
							0,05	0,08	0,1	0,12																	15	12	10				
							0,08	0,12	0,15	0,18																	20	20	15				
							0,12	0,15	0,18	0,18																	70	60	50				
							0,12	0,15	0,18	0,18																	60	50	40				

HC = Coated carbide

Cutting data for drilling with Xtra-tec® Insert Drill D_C 13.5–59 mm

Material group	Structure of main material groups and code letters		Brinell hardness HB	Tensile strength R _m N/mm ²	Machining group ¹	= Cutting data for wet machining = Dry machining is possible	Insert geometry						
							Starting values for feed f [mm/U]						
							A 57						
							Size -1	Size -2	Size -3	Size -4	Size -5 Size -6	Size -7 Size -8	
D _C [mm]						13,5–16,4	16,5–20,4	20,5–24,4	24,5–29,4	29,5–42,4	42,5–59,4		
P	Non-alloyed steel	C ≤ 0.25%	annealed	125	428	P1	●●	0,05	0,06	0,06	0,09	0,12	0,13
		C > 0.25 ... ≤ 0.55%	annealed	190	639	P2	●●	0,07	0,09	0,10	0,13	0,18	0,19
		C > 0.25 ... ≤ 0.55%	tempered	210	708	P3	●●	0,07	0,09	0,10	0,13	0,18	0,19
		C > 0.55%	annealed	190	639	P4	●●	0,07	0,09	0,10	0,13	0,18	0,19
		C > 0.55%	tempered	300	1013	P5	●●	0,07	0,09	0,10	0,13	0,18	0,19
	Low-alloyed steel	machining steel (short-chipping)	annealed	220	745	P6	●● ●	0,07	0,09	0,10	0,13	0,18	0,19
		annealed		175	591	P7	●●	0,08	0,10	0,12	0,15	0,20	0,21
		tempered		300	1013	P8	●●	0,07	0,09	0,10	0,13	0,15	0,16
		tempered		380	1282	P9	●●	0,07	0,09	0,10	0,13	0,15	0,16
		tempered		430	1477	P10	●●	0,05	0,06	0,06	0,09	0,12	0,13
High-alloyed steel and high-alloyed tool steel	annealed		200	675	P11	●●	0,08	0,10	0,12	0,15	0,18	0,19	
	hardened and tempered		300	1013	P12	●●	0,07	0,09	0,10	0,13	0,15	0,16	
	hardened and tempered		400	1361	P13	●●	0,06	0,08	0,09	0,12	0,14	0,15	
Stainless steel	ferritic/martensitic, annealed		200	675	P14	●●	0,07	0,09	0,10	0,13	0,15	0,16	
	martensitic, tempered		330	1114	P15	●●	0,06	0,08	0,09	0,12	0,14	0,15	
M	Stainless steel	austenitic, quench hardened		200	675	M1	●●	0,06	0,07	0,08	0,10	0,13	0,14
		austenitic, precipitation hardened (PH)		300	1013	M2	●●	0,06	0,07	0,08	0,10	0,13	0,14
		austenitic/ferritic, duplex		230	778	M3	●●	0,06	0,07	0,08	0,10	0,13	0,14
K	Malleable cast iron	ferritic		200	675	K1	●● ●	0,09	0,12	0,14	0,17	0,22	0,23
		pearlitic		260	867	K2	●● ●	0,07	0,09	0,11	0,14	0,19	0,20
	Grey cast iron	low tensile strength		180	602	K3	●● ●	0,10	0,13	0,15	0,18	0,23	0,24
		high tensile strength/austenitic		245	825	K4	●● ●	0,08	0,10	0,12	0,15	0,20	0,21
	Cast iron with spheroidal graphite	ferritic		155	518	K5	●● ●	0,10	0,13	0,15	0,18	0,23	0,24
		pearlitic		265	885	K6	●●	0,08	0,10	0,12	0,18	0,23	0,24
GGV (CGI)		200	675	K7	●● ●	0,09	0,12	0,14	0,17	0,22	0,23		
N	Aluminium wrought alloys	cannot be hardened		30	–	N1							
		hardenable, hardened		100	343	N2	●●						
	Cast aluminium alloys	≤ 12% Si, cannot be hardened		75	260	N3	●●						
		≤ 12% Si, hardenable, hardened		90	314	N4	●●						
		> 12% Si, cannot be hardened		130	447	N5	●● ●						
	Magnesium alloys		70	250	N6	●●							
	Copper and copper alloys (bronze/brass)	non-alloyed, electrolytic copper		100	343	N7							
brass, bronze, red brass			90	314	N8	●●							
Cu-alloys, short-chipping			110	382	N9	●● ●							
high-strength, Ampco			300	1013	N10	●● ●	0,06	0,07	0,08	0,10	0,13	0,14	
S	Heat-resistant alloys	Fe-based	annealed	200	675	S1	●●						
			hardened	280	943	S2	●●						
		Ni or Co base	annealed	250	839	S3	●●						
			hardened	350	1177	S4	●●						
			cast	320	1076	S5	●●						
	Titanium alloys	pure titanium	200	675	S6								
α and β alloys, hardened	375	1262	S7	●●									
β alloys	410	1396	S8	●●									
Tungsten alloys		300	1013	S9	●●	0,05	0,06	0,06	0,09	0,11	0,12		
Molybdenum alloys		300	1013	S10	●●	0,05	0,06	0,06	0,09	0,11	0,12		
H	Hardened steel	hardened and tempered		50 HRC	–	H1	●●	0,05	0,06	0,06	0,09	0,10	0,10
		hardened and tempered		55 HRC	–	H2	●●	0,05	0,06	0,06	0,09	0,10	0,10
		hardened and tempered		60 HRC	–	H3							
Hardened cast iron	hardened and tempered		55 HRC	–	H4	●●	0,05	0,06	0,06	0,09	0,10	0,10	
O	Thermoplasts	without abrasive fillers				O1	●● ●						
	Thermosetting plastics	without abrasive fillers				O2	●● ●						
	Plastic, glass fibre reinforced	GFRP				O3							
	Plastic, carbon fibre reinforced	CFRP				O4							
	Plastic, aramid fibre reinforced	AFRP				O5							
	Graphite (technical)		80 Shore			O6	●● ●	0,09	0,12	0,14	0,17	0,22	0,23

¹ The classification of the machining groups can be found in the Walter General catalogue 2012 from page H 8 onwards.

- Recommended application (the specified cutting data are regarded as starting values for the recommended application).
- Possible application. Limited to 2 x D_C drilling depth. MQL (minimum quantity lubrication) or compressed air is recommended.

When using drills > 3 x D, the following reductions are recommended:
 > 3 x D: Cutting speed v_c –20 %, feed f –30 % when spot drilling, feed f –50 % when spot drilling on inclined surfaces.
 > 4 x D: Cutting speed v_c –30 %, feed f –40 % when spot drilling.

The specified cutting data are average recommended values.
For special applications, adjustment is recommended.

Insert geometry												Cutting material grade Outer insert [P484.P.]											
Starting values for feed f [mm/U]												Starting values for cutting speed v _c [m/min]											
E 57						E 67						HC											
Size -1	Size -2	Size -3	Size -4	Size -5 Size -6	Size -7 Size -8	Size -1	Size -2	Size -3	Size -4	Size -5 Size -6	Size -7 Size -8	WKP25S f [mm/U]			WKP35S f [mm/U]			WSP45 f [mm/U]					
D _c [mm]						D _c [mm]						0,06	0,10	0,16	0,06	0,10	0,16	0,06	0,10	0,16			
13,5-16,4	16,5-20,4	20,5-24,4	24,5-29,4	29,5-42,4	42,5-59,4	13,5-16,4	16,5-20,4	20,5-24,4	24,5-29,4	29,5-42,4	42,5-59,4												
0,05	0,06	0,06	0,09	0,12	0,13	0,05	0,06	0,06	0,09	0,12	0,13	350	320		300	270		250	220				
0,06	0,07	0,08	0,11	0,17	0,18	0,06	0,07	0,08	0,11	0,17	0,18	260	240	220	220	200	180	170	160	150			
0,06	0,07	0,08	0,11	0,17	0,18							240	220	200	200	180	150	150	140	130			
0,06	0,07	0,08	0,11	0,17	0,18							220	200	180	180	150	140	140	130	120			
0,06	0,07	0,08	0,11	0,17	0,18							190	170	150	150	130	120	130	120	110			
0,06	0,07	0,08	0,11	0,17	0,18							220	200	180	180	150	140	140	130	120			
0,06	0,08	0,10	0,13	0,19	0,20	0,06	0,08	0,10	0,14	0,20	0,21	260	240	220	220	200	180	170	160	160			
0,06	0,07	0,08	0,11	0,14	0,15							230	210	190	190	170	140	140	130	120			
0,06	0,07	0,08	0,11	0,14	0,15							210	190	170	180	160	130	140	120	110			
0,05	0,06	0,06	0,09	0,11	0,12							190	170	160	170	140	130	140	120	110			
0,06	0,08	0,10	0,13	0,17	0,18	0,06	0,08	0,10	0,12	0,16	0,17	220	200	180	200	170	150	140	130	120			
0,06	0,07	0,08	0,11	0,14	0,15							200	170	150	180	140	130	130	120	110			
0,05	0,06	0,07	0,10	0,13	0,14							190	160	140	170	130	120	120	110	100			
0,06	0,07	0,08	0,11	0,14	0,15	0,06	0,07	0,08	0,11	0,14	0,15				190	170	150	140	130	120			
0,05	0,06	0,07	0,10	0,13	0,14	0,05	0,06	0,07	0,10	0,13	0,15				150	130	120	120	110	100			
0,06	0,07	0,08	0,10	0,13	0,14	0,06	0,07	0,09	0,12	0,14	0,15				220	200	180	180	170	150			
0,06	0,07	0,08	0,10	0,13	0,14	0,06	0,07	0,09	0,12	0,14	0,15				150	130	110	130	110	100			
0,06	0,07	0,08	0,10	0,13	0,14	0,06	0,07	0,09	0,12	0,14	0,15				120	100	80	100	80	70			
0,07	0,09	0,11	0,14	0,21	0,22	0,07	0,09	0,11	0,14	0,21	0,22	210	190	170	190	180	160	170	140	120			
0,05	0,07	0,08	0,11	0,18	0,19	0,05	0,07	0,09				190	140	120	130	120	110	130	120	110			
0,08	0,10	0,12	0,15	0,22	0,23	0,08	0,10	0,12	0,15	0,22	0,23	220	200	180	200	190	170	180	160	130			
0,06	0,08	0,09	0,12	0,19	0,20							180	150	130	150	130	110	150	130	110			
0,08	0,10	0,12	0,15	0,22	0,23	0,08	0,10	0,12	0,15	0,22	0,23	150	140	130	140	120	110	150	130	120			
0,06	0,08	0,09	0,12	0,22	0,23	0,06	0,08					140	130	120	120	110	100	120	110	110			
0,07	0,09	0,11	0,14	0,21	0,22	0,07	0,09	0,11	0,14	0,21	0,22	180	150	130	150	130	110	150	130	110			
0,07	0,09	0,10	0,12	0,17	0,18	0,07	0,09	0,11	0,12	0,17	0,18							450	450	450			
0,08	0,10	0,12	0,15	0,17	0,18	0,08	0,10	0,12	0,15	0,17	0,18							300	300	300			
0,08	0,10	0,12	0,15	0,17	0,18	0,08	0,10	0,12	0,15	0,17	0,18							250	250	250			
0,08	0,10	0,12	0,15	0,17	0,18	0,08	0,10	0,12	0,15	0,17	0,18							200	200	200			
0,08	0,10	0,12	0,15	0,17	0,18	0,08	0,10	0,12	0,15	0,17	0,18							300	300	300			
0,10	0,12	0,14	0,17	0,22	0,23	0,10	0,12	0,14	0,17	0,22	0,23							300	250	200			
0,10	0,12	0,14	0,17	0,22	0,23	0,10	0,12	0,14	0,17	0,22	0,23							350	300	250			
0,06	0,07	0,08	0,10	0,13	0,14	0,06	0,07	0,09	0,12	0,14	0,15				150	130	110	130	110	100			
0,05	0,06	0,07	0,10	0,13	0,14	0,05	0,06	0,07	0,10	0,13	0,14	100	100		100	100		90	90				
0,05	0,06	0,06	0,09	0,11	0,12	0,05	0,06	0,06	0,09	0,11	0,12	80	80		80	80		70	70				
0,05	0,06	0,07	0,10	0,12	0,13	0,05	0,06	0,07	0,10	0,12	0,13	60	60		60	60		50	50				
0,05	0,06	0,06	0,09	0,11	0,12	0,05	0,06	0,06	0,09	0,11	0,12	50	50		50	50		40	40				
0,05	0,06	0,06	0,09	0,11	0,12	0,05	0,06	0,06	0,09	0,11	0,12	50	50		50	50		40	40				
0,05	0,06	0,07	0,10	0,12	0,13	0,05	0,06	0,07	0,10	0,12	0,13				50	50		50	45				
0,05	0,06	0,06	0,09	0,11	0,12	0,05	0,06	0,06	0,09	0,11	0,12				50	50		40	40				
0,05	0,06	0,06	0,09	0,11	0,12	0,05	0,06	0,06	0,09	0,11	0,12	70	60										
0,05	0,06	0,06	0,09	0,10	0,10							70	60										
0,05	0,06	0,06	0,09	0,10	0,10							70	60	50									
0,05	0,06	0,06	0,09	0,10	0,10							60	50	50									
0,05	0,06	0,06	0,09	0,10	0,10							60	50	50									
0,16	0,18	0,20	0,25	0,30	0,30	0,16	0,18	0,20	0,25	0,30	0,30				400	400	400	400	400	400			
0,12	0,14	0,18	0,20	0,25	0,25	0,12	0,14	0,18	0,20	0,25	0,25	300	300	300	300	300	300	300	300	300			
0,07	0,09	0,11	0,14	0,21	0,22							300	250	200	250	200	150	250	200	150			

HC = Coated carbide

Cutting data for drilling with WOMX-/WOEX indexable inserts

Material group	Structure of main material groups and code letters		Brinell hardness HB	Tensile strength R _m N/mm ²	Machining group ¹			Insert geometry				
								Starting values for feed f [mm/U]				
								WOMX-B57				
								D _c [mm]				
							14–19,9	20–24,9	25–44,9	>45		
P	Non-alloyed steel	C ≤ 0.25%	annealed	125	428	P1	●●		0,05	0,07	0,08	0,10
		C > 0.25 ... ≤ 0.55%	annealed	190	639	P2	●●		0,05	0,07	0,08	0,10
		C > 0.25 ... ≤ 0.55%	tempered	210	708	P3	●●		0,05	0,07	0,08	0,10
		C > 0.55%	annealed	190	639	P4	●●		0,05	0,07	0,08	0,10
		C > 0.55%	tempered	300	1013	P5	●●		0,05	0,07	0,08	0,10
		machining steel (short-chipping)	annealed	220	745	P6	●●	●	0,06	0,07	0,08	0,10
	Low-alloyed steel		annealed	175	591	P7	●●		0,06	0,07	0,08	0,10
			tempered	300	1013	P8	●●		0,06	0,07	0,08	0,10
			tempered	380	1282	P9	●●		0,06	0,07	0,08	0,10
			tempered	430	1477	P10	●●		0,04	0,05	0,06	0,09
	High-alloyed steel and high-alloyed tool steel		annealed	200	675	P11	●●		0,04	0,05	0,06	0,09
			hardened and tempered	300	1013	P12	●●		0,04	0,05	0,06	0,09
			hardened and tempered	400	1361	P13	●●		0,04	0,05	0,06	0,09
	Stainless steel		ferritic/martensitic, annealed	200	675	P14	●●		0,04	0,05	0,08	0,10
			martensitic, tempered	330	1114	P15	●●		0,04	0,05	0,08	0,10
		annealed	200	675	M1	●●		0,04	0,06	0,07	0,10	
M	Stainless steel	austenitic, quench hardened	200	675	M1	●●		0,04	0,06	0,07	0,10	
		austenitic, precipitation hardened (PH)	300	1013	M2	●●		0,04	0,06	0,07	0,10	
		austenitic/ferritic, duplex	230	778	M3	●●		0,04	0,06	0,07	0,10	
K	Malleable cast iron	ferritic	200	675	K1	●●	●	0,05	0,07	0,09	0,12	
		pearlitic	260	867	K2	●●	●	0,05	0,07	0,09	0,12	
	Grey cast iron	low tensile strength	180	602	K3	●●	●	0,05	0,07	0,09	0,12	
		high tensile strength/austenitic	245	825	K4	●●	●	0,05	0,07	0,09	0,12	
	Cast iron with spheroidal graphite	ferritic	155	518	K5	●●	●	0,04	0,05	0,09	0,12	
		pearlitic	265	885	K6	●●	●	0,04	0,05	0,09	0,12	
	GGV (CGI)		200	675	K7	●●	●	0,05	0,07	0,09	0,12	
N	Aluminium wrought alloys	cannot be hardened	30	–	N1	●●						
		hardenable, hardened	100	343	N2	●●						
	Cast aluminium alloys	≤ 12% Si, cannot be hardened	75	260	N3	●●						
		≤ 12% Si, hardenable, hardened	90	314	N4	●●						
		> 12% Si, cannot be hardened	130	447	N5	●●						
	Magnesium alloys		70	250	N6	●●						
	Copper and copper alloys (bronze/brass)	non-alloyed, electrolytic copper		100	343	N7	●●					
		brass, bronze, red brass		90	314	N8	●●					
		Cu-alloys, short-chipping		110	382	N9	●●					
		high-strength, Ampco		300	1013	N10	●●					
S	Heat-resistant alloys	Fe-based	annealed	200	675	S1	●●		0,04	0,05	0,06	0,06
			hardened	280	943	S2	●●		0,04	0,05	0,06	0,06
		Ni or Co base	annealed	250	839	S3	●●					
			hardened	350	1177	S4	●●					
			cast	320	1076	S5	●●					
	Titanium alloys	pure titanium		200	675	S6	●●					
		α and β alloys, hardened		375	1262	S7	●●					
		β alloys		410	1396	S8	●●					
	Tungsten alloys		300	1013	S9	●●						
	Molybdenum alloys		300	1013	S10	●●						
H	Hardened steel	hardened and tempered	50 HRC	–	H1	●●						
		hardened and tempered	55 HRC	–	H2	●●						
		hardened and tempered	60 HRC	–	H3	●●						
	Hardened cast iron	hardened and tempered	55 HRC	–	H4	●●						
O	Thermoplasts	without abrasive fillers			O1	●●	●					
	Thermosetting plastics	without abrasive fillers			O2	●●	●					
	Plastic, glass fibre reinforced	GFRP			O3	●●						
	Plastic, carbon fibre reinforced	CFRP			O4	●●						
	Plastic, aramid fibre reinforced	AFRP			O5	●●						
	Graphite (technical)		80 Shore		O6	●●	●					

¹The classification of the machining groups can be found in the Walter General catalogue 2012 from page H 8 onwards.

- Recommended application (the specified cutting data are regarded as starting values for the recommended application).
- Possible application. Limited to 2 x D_c drilling depth. MQL (minimum quantity lubrication) or compressed air is recommended.



The specified cutting data are average recommended values.
For special applications, adjustment is recommended.

Insert geometry										Cutting material grades											
Starting values for feed f [mm/U]										Starting values for cutting speed v _c [m/min]											
WOMX-D57					WOEX-E57					HC											
D _c [mm]					D _c [mm]					WKP255 f [mm/U]			WKP355 f [mm/U]			WAK15 f [mm/U]			WXP40 f [mm/U]		
12- 13,9	14- 19,9	20- 24,9	25- 44,9	>45	14- 19,9	20- 24,9	25- 44,9	>45	bis 0,04	bis 0,08	bis 0,16	bis 0,04	bis 0,08	bis 0,16	bis 0,04	bis 0,08	bis 0,16	bis 0,04	bis 0,08	bis 0,16	
0,05	0,06	0,08	0,10	0,12	0,06	0,08	0,10	0,12	240	230	200	220	200	180				140	130	120	
0,05	0,06	0,08	0,10	0,12	0,06	0,08	0,10	0,12	240	230	200	220	200	180				140	130	120	
0,05	0,06	0,08	0,10	0,12	0,06	0,08	0,10	0,12	240	230	200	220	200	180				140	130	120	
0,05	0,06	0,08	0,10	0,12	0,06	0,08	0,10	0,12	240	230	200	220	200	180				140	130	120	
0,06	0,07	0,08	0,10	0,14	0,07	0,08	0,10	0,14	240	230	200	220	200	180				140	130	120	
0,06	0,07	0,08	0,10	0,14	0,07	0,08	0,10	0,14	230	220	190	210	200	170				130	120	110	
0,06	0,07	0,08	0,10	0,14	0,07	0,08	0,10	0,14	230	220	190	210	200	170				130	120	110	
0,06	0,07	0,08	0,10	0,14	0,07	0,08	0,10	0,14	230	220	190	210	200	170				130	120	110	
0,05	0,05	0,06	0,07	0,10	0,05	0,06	0,07	0,10	200	180	170	190	170	150				130	120	110	
0,05	0,05	0,06	0,07	0,10	0,05	0,06	0,07	0,10	200	180	170	190	170	150				130	120	110	
0,05	0,05	0,06	0,07	0,10	0,05	0,06	0,07	0,10	200	180	170	190	170	150				130	120	110	
0,05	0,05	0,06	0,07	0,10	0,05	0,06	0,07	0,10	200	180	170	190	170	150				130	120	110	
0,05	0,06	0,08	0,09	0,12	0,06	0,08	0,09	0,12	180	160	150	160	140	120				130	120	110	
0,05	0,06	0,08	0,09	0,12	0,06	0,08	0,09	0,12	180	160	150	160	140	120				130	120	110	
0,05	0,06	0,08	0,09	0,12	0,06	0,08	0,09	0,12				200	180	160				160	150	140	
0,05	0,06	0,08	0,09	0,12	0,06	0,08	0,09	0,12				150	130	110				130	110	100	
0,05	0,06	0,08	0,09	0,12	0,06	0,08	0,09	0,12				120	100	80				100	100	70	
0,07	0,09	0,10	0,12	0,16	0,09	0,10	0,12	0,16	150	140	130	140	130	120	180	160	150	120	120	110	
0,07	0,09	0,10	0,12	0,16	0,09	0,10	0,12	0,16	150	140	130	140	130	120	180	160	150	120	120	110	
0,07	0,10	0,12	0,14	0,16	0,10	0,12	0,14	0,16	150	140	130	140	130	120	200	180	160	120	120	110	
0,07	0,10	0,12	0,14	0,16	0,10	0,12	0,14	0,16	150	140	130	140	130	120	200	180	160	120	120	110	
0,06	0,08	0,12	0,14	0,16	0,08	0,12	0,14	0,16	130	120	120	120	120	110	160	150	140	110	110	100	
0,06	0,08	0,12	0,14	0,16	0,08	0,12	0,14	0,16	130	120	120	120	120	110	160	150	140	110	110	100	
0,07	0,09	0,10	0,12	0,16	0,09	0,10	0,12	0,16	150	140	130	140	130	120	200	180	160	120	120	110	
0,05	0,06	0,06	0,06	0,08	0,06	0,06	0,06	0,08				80	70	70				60	60	60	
0,05	0,06	0,06	0,06	0,08	0,06	0,06	0,06	0,08				80	70	70				60	60	60	
		0,06	0,06	0,08		0,06	0,06	0,08				50	40	40				40	40	40	
		0,06	0,06	0,08		0,06	0,06	0,08				50	40	40				40	40	40	
		0,06	0,06	0,08		0,06	0,06	0,08				50	40	40				40	40	40	
0,05	0,05	0,06	0,08	0,10											60	50	50				
0,05	0,05	0,06	0,08	0,10											60	50	50				
0,05	0,05	0,06	0,08	0,10											60	50	50				
0,16	0,18	0,20	0,30	0,30								400	400	400				400	400	400	
0,12	0,14	0,18	0,20	0,25								300	300	300				300	300	300	
0,07	0,09	0,11	0,21	0,22								150	150	150				150	150	150	

HC = Coated carbide

Cutting data for boring

Material group	Structure of main material groups and code letters		Brinell hardness HB	Tensile strength R_m N/mm ²	Machining group ¹		Insert geometry						
							Starting values for feed f [mm/U]						
							-E47			-PM5			
						D _c [mm]		D _c [mm]					
						<44	>44-73	>73	<44	>44-73	>73		
P	Non-alloyed steel	C ≤ 0.25%	annealed	125	428	P1	●●	0,20	0,30	0,40	2,20	0,30	0,40
		C > 0.25 ... ≤ 0.55%	annealed	190	639	P2	●●	0,16	0,24	0,40	0,16	0,24	0,40
		C > 0.25 ... ≤ 0.55%	tempered	210	708	P3	●●	0,15	0,22	0,35	0,15	0,22	0,35
		C > 0.55%	annealed	190	639	P4	●●	0,14	0,20	0,30	0,14	0,20	0,30
		C > 0.55%	tempered	300	1013	P5	●●	0,12	0,18	0,25	0,12	0,18	0,25
	machining steel (short-chipping)		annealed	220	745	P6	●● ●	0,15	0,22	0,35	0,15	0,22	0,35
	Low-alloyed steel	annealed		175	591	P7	●●	0,20	0,30	0,40	0,20	0,30	0,40
		tempered		300	1013	P8	●●	0,14	0,20	0,30	0,14	0,20	0,30
		tempered		380	1282	P9	●●	0,12	0,18	0,25	0,12	0,18	0,25
		tempered		430	1477	P10	●●	0,10	0,15	0,20	0,10	0,15	0,20
	High-alloyed steel and high-alloyed tool steel	annealed		200	675	P11	●●	0,14	0,20	0,30	0,14	0,20	0,30
		hardened and tempered		300	1013	P12	●●	0,13	0,18	0,27	0,13	0,18	0,27
		hardened and tempered		400	1361	P13	●●	0,10	0,15	0,20	0,10	0,15	0,20
	Stainless steel	ferritic/martensitic, annealed		200	675	P14	●●	0,12	0,16	0,24	0,12	0,16	0,24
		martensitic, tempered		330	1114	P15	●●	0,12	0,16	0,24	0,12	0,16	0,24
M	Stainless steel	austenitic, quench hardened	200	675	M1	●●	0,12	0,16	0,24	0,12	0,16	0,24	
		austenitic, precipitation hardened (PH)	300	1013	M2	●●	0,12	0,16	0,24	0,12	0,16	0,24	
		austenitic/ferritic, duplex	230	778	M3	●●	0,12	0,16	0,24	0,12	0,16	0,24	
K	Malleable cast iron	ferritic	200	675	K1	●● ●	0,18	0,26	0,34	0,18	0,26	0,34	
		pearlitic	260	867	K2	●● ●	0,16	0,24	0,30	0,16	0,24	0,30	
	Grey cast iron	low tensile strength	180	602	K3	●● ●	0,20	0,30	0,40	0,20	0,30	0,40	
		high tensile strength/austenitic	245	825	K4	●● ●	0,16	0,24	0,30	0,16	0,24	0,30	
	Cast iron with spheroidal graphite	ferritic	155	518	K5	●● ●	0,20	0,30	0,40	0,20	0,30	0,40	
		pearlitic	265	885	K6	●●	0,16	0,24	0,30	0,16	0,24	0,30	
	GGV (CGI)		200	675	K7	●● ●	0,18	0,26	0,34	0,18	0,26	0,34	
N	Aluminium wrought alloys	cannot be hardened	30	-	N1	●●							
		hardenable, hardened	100	343	N2	●●							
	Cast aluminium alloys	≤ 12% Si, cannot be hardened	75	260	N3	●● ●							
		≤ 12% Si, hardenable, hardened	90	314	N4	●● ●							
		> 12% Si, cannot be hardened	130	447	N5	●● ●							
	Magnesium alloys		70	250	N6	●● ●							
	Copper and copper alloys (bronze/brass)	non-alloyed, electrolytic copper		100	343	N7	●●	0,16	0,24	0,40	0,16	0,24	0,40
		brass, bronze, red brass		90	314	N8	●● ●	0,16	0,24	0,40	0,16	0,24	0,40
		Cu-alloys, short-chipping		110	382	N9	●● ●	0,16	0,24	0,40	0,16	0,24	0,40
		high-strength, Ampco		300	1013	N10	●●						
S	Heat-resistant alloys	Fe-based	annealed	200	675	S1	●●	0,10	0,15	0,20	0,10	0,15	0,20
			hardened	280	943	S2	●●	0,10	0,15	0,20	0,10	0,15	0,20
		Ni or Co base	annealed	250	839	S3	●●	0,10	0,15	0,20	0,10	0,15	0,20
			hardened	350	1177	S4	●●	0,10	0,15	0,20	0,10	0,15	0,20
			cast	320	1076	S5	●●	0,10	0,15	0,20	0,10	0,15	0,20
	Titanium alloys	pure titanium		200	675	S6							
		α and β alloys, hardened		375	1262	S7	●●	0,14	0,16	0,24	0,14	0,16	0,24
		β alloys		410	1396	S8	●●	0,12	0,14	0,22	0,12	0,14	0,22
	Tungsten alloys		300	1013	S9								
	Molybdenum alloys		300	1013	S10								
H	Hardened steel	hardened and tempered		50 HRC	-	H1							
		hardened and tempered		55 HRC	-	H2							
		hardened and tempered		60 HRC	-	H3							
	Hardened cast iron	hardened and tempered		55 HRC	-	H4							
O	Thermoplasts	without abrasive fillers				O1							
	Thermosetting plastics	without abrasive fillers				O2							
	Plastic, glass fibre reinforced	GFRP				O3							
	Plastic, carbon fibre reinforced	CFRP				O4							
	Plastic, aramid fibre reinforced	AFRP				O5							
	Graphite (technical)			80 Shore		O6							

¹The classification of the machining groups can be found in the Walter General catalogue 2012 from page H 8 onwards.

- Recommended application (the specified cutting data are regarded as starting values for the recommended application).
- Possible application. Cutting speed v_c -30%, with compressed air or MQL (minimum quantity lubrication).

The specified cutting data are average recommended values.
For special applications, adjustment is recommended.

Insert geometry				Cutting material grade																				
				Starting values for feed f [mm/U]						Starting values for cutting speed v _c [m/min]														
-PF2 / -PM2 D _c [mm] <44 >44-73 >73			-PF4 / -PS5 D _c [mm] <44 >44-73 >73			HC									WSM10			WSM20			WSM30			
						WPP01 / WPP10			WPP20			WPP30			f [mm/U]			f [mm/U]			f [mm/U]			
						f [mm/U]			f [mm/U]			f [mm/U]			f [mm/U]			f [mm/U]			f [mm/U]			
						0,1	0,2	0,4	0,1	0,2	0,4	0,1	0,2	0,4	0,1	0,2	0,4	0,1	0,2	0,4	0,1	0,2	0,4	
				0,16	0,24	0,32	300	280		280	260	240	260	240	220				240	220		220	20	
				0,13	0,19	0,32	280	260		260	240	220	220	200	180				180	160		160	140	
				0,12	0,18	0,28	260	240		240	220	200	200	180	160				140	120		120	100	
				0,11	0,16	0,24	250	220		220	200	180	180	160	140				160	140		140	120	
				0,10	0,14	0,20	220	200		200	180	160	140	130	120									
				0,12	0,18	0,28	260	240		240	220	200	200	180	160				160	140		140	120	
				0,16	0,24	0,32	280	260		260	240	220	220	200	180									
				0,11	0,16	0,24	240	220		220	200	180	180	160	150									
				0,10	0,14	0,20	210	190		190	170	150	130	120	110									
				0,08	0,12	0,16	180	160		160	120	100	120	100	80									
				0,11	0,16	0,24	220	200		220	200		180	160	150									
				0,11	0,16	0,24	180	160		180	160		160	150	140									
				0,08	0,12	0,16	180	160		160	120	100	120	100	80									
				0,10	0,13	0,19				220	200		160	130										
				0,10	0,13	0,19				170	150		130	110										
				0,10	0,13	0,19							220	200		220	170		200	180		140	100	70
				0,10	0,13	0,19							180	160		160	120		150	120		110	100	50
				0,10	0,13	0,19							200	180		180	140		170	140		130	120	60
				0,14	0,22	0,30	220	200	160	200	180	140	180	160	120									
				0,13	0,19	0,24	170	150	140	160	150	130	160	140	120									
				0,16	0,24	0,32	240	220	180	220	200	160	200	180	140									
				0,13	0,19	0,24	170	150	140	160	150	130	160	140	120									
				0,16	0,24	0,32	200	180	160	180	160	140	150	140	120									
				0,13	0,19	0,24	180	160	140	160	140	130	160	130	110									
				0,14	0,22	0,30	165	150	130															
	0,24	0,30	0,40																					
	0,24	0,30	0,40																					
	0,24	0,30	0,40																					
	0,24	0,30	0,40																					
	0,24	0,30	0,40																					
	0,24	0,30	0,40	0,13	0,19	0,32	300	250	220	300	250	200												
	0,24	0,30	0,40	0,13	0,19	0,32	350	300	250	330	300	250												
	0,24	0,30	0,40	0,13	0,19	0,32	400	360	300	350	330	300												
				0,08	0,12	0,16										90	90		80	80		60	35	
				0,08	0,12	0,16										70	70		60	60		40	30	
				0,08	0,12	0,16										60	60		50	50		40	20	
				0,08	0,12	0,16										50	50		40	40		35	20	
				0,08	0,12	0,16										50	50		40	40		30	10	
				0,11	0,13	0,19										60	60		50	50				
				0,09	0,11	0,16										50	50		40	40				

HC = Coated carbide

Cutting data for counterboring

Material group	Structure of main material groups and code letters		Brinell hardness HB	Tensile strength R _m N/mm ²	Machining group ¹		Insert geometry							
							Starting values for feed f [mm/U]							
							– E47			– PM5				
							D _c [mm]		D _c [mm]		D _c [mm]			
		<44	>44-73	>73	<44	>44-73	>73							
P	Non-alloyed steel	C ≤ 0.25% annealed	125	428	P1	●●	0,20	0,30	0,40	2,20	0,30	0,40		
		C > 0.25 ... ≤ 0.55% annealed	190	639	P2	●●	0,16	0,24	0,40	0,16	0,24	0,40		
		C > 0.25 ... ≤ 0.55% tempered	210	708	P3	●●	0,15	0,22	0,35	0,15	0,22	0,35		
		C > 0.55% annealed	190	639	P4	●●	0,14	0,20	0,30	0,14	0,20	0,30		
		C > 0.55% tempered	300	1013	P5	●●	0,12	0,18	0,25	0,12	0,18	0,25		
	machining steel (short-chipping) annealed	220	745	P6	●● ●	0,15	0,22	0,35	0,15	0,22	0,35			
	Low-alloyed steel	annealed	175	591	P7	●●	0,20	0,30	0,40	0,20	0,30	0,40		
		tempered	300	1013	P8	●●	0,14	0,20	0,30	0,14	0,20	0,30		
		tempered	380	1282	P9	●●	0,12	0,18	0,25	0,12	0,18	0,25		
		tempered	430	1477	P10	●●	0,10	0,15	0,20	0,10	0,15	0,20		
High-alloyed steel and high-alloyed tool steel	annealed	200	675	P11	●●	0,14	0,20	0,30	0,14	0,20	0,30			
	hardened and tempered	300	1013	P12	●●	0,13	0,18	0,27	0,13	0,18	0,27			
	hardened and tempered	400	1361	P13	●●	0,10	0,15	0,20	0,10	0,15	0,20			
Stainless steel	ferritic/martensitic, annealed	200	675	P14	●●	0,12	0,16	0,24	0,12	0,16	0,24			
	martensitic, tempered	330	1114	P15	●●	0,12	0,16	0,24	0,12	0,16	0,24			
	Stainless steel	200	675	P14	●●	0,12	0,16	0,24	0,12	0,16	0,24			
M	Stainless steel	austenitic, quench hardened	200	675	M1	●●	0,12	0,16	0,24	0,12	0,16	0,24		
		austenitic, precipitation hardened (PH)	300	1013	M2	●●	0,12	0,16	0,24	0,12	0,16	0,24		
		austenitic/ferritic, duplex	230	778	M3	●●	0,12	0,16	0,24	0,12	0,16	0,24		
K	Malleable cast iron	ferritic	200	675	K1	●● ●	0,18	0,26	0,34	0,18	0,26	0,34		
		pearlitic	260	867	K2	●● ●	0,16	0,24	0,30	0,16	0,24	0,30		
	Grey cast iron	low tensile strength	180	602	K3	●● ●	0,20	0,30	0,40	0,20	0,30	0,40		
		high tensile strength/austenitic	245	825	K4	●● ●	0,16	0,24	0,30	0,16	0,24	0,30		
	Cast iron with spheroidal graphite	ferritic	155	518	K5	●● ●	0,20	0,30	0,40	0,20	0,30	0,40		
		pearlitic	265	885	K6	●●	0,16	0,24	0,30	0,16	0,24	0,30		
GGV (CGI)		200	675	K7	●● ●	0,18	0,26	0,34	0,18	0,26	0,34			
N	Aluminium wrought alloys	cannot be hardened	30	–	N1	●●								
		hardenable, hardened	100	343	N2	●●								
	Cast aluminium alloys	≤ 12% Si, cannot be hardened	75	260	N3	●● ●								
		≤ 12% Si, hardenable, hardened	90	314	N4	●● ●								
		> 12% Si, cannot be hardened	130	447	N5	●● ●								
	Magnesium alloys		70	250	N6	●● ●								
	Copper and copper alloys (bronze/brass)	non-alloyed, electrolytic copper	100	343	N7	●●	0,16	0,24	0,40	0,16	0,24	0,40		
brass, bronze, red brass		90	314	N8	●● ●	0,16	0,24	0,40	0,16	0,24	0,40			
Cu-alloys, short-chipping		110	382	N9	●● ●	0,16	0,24	0,40	0,16	0,24	0,40			
high-strength, Ampco		300	1013	N10	●●									
S	Heat-resistant alloys	Fe-based	annealed	200	675	S1	●●	0,10	0,15	0,20	0,10	0,15	0,20	
			hardened	280	943	S2	●●	0,10	0,15	0,20	0,10	0,15	0,20	
		Ni or Co base	annealed	250	839	S3	●●	0,10	0,15	0,20	0,10	0,15	0,20	
			hardened	350	1177	S4	●●	0,10	0,15	0,20	0,10	0,15	0,20	
			cast	320	1076	S5	●●	0,10	0,15	0,20	0,10	0,15	0,20	
	Titanium alloys	pure titanium	200	675	S6									
		α and β alloys, hardened	375	1262	S7	●●	0,14	0,16	0,24	0,14	0,16	0,24		
Tungsten alloys		300	1013	S9	●●	0,12	0,14	0,22	0,12	0,14	0,22			
Molybdenum alloys		300	1013	S10										
H	Hardened steel	hardened and tempered	50 HRC	–	H1									
		hardened and tempered	55 HRC	–	H2									
		hardened and tempered	60 HRC	–	H3									
	Hardened cast iron	hardened and tempered	55 HRC	–	H4									
O	Thermoplasts	without abrasive fillers			O1									
	Thermosetting plastics	without abrasive fillers			O2									
	Plastic, glass fibre reinforced	GFRP			O3									
	Plastic, carbon fibre reinforced	CFRP			O4									
	Plastic, aramid fibre reinforced	AFRP			O5									
	Graphite (technical)		80 Shore			O6								

¹ The classification of the machining groups can be found in the Walter General catalogue 2012 from page H 8 onwards.

- Recommended application (the specified cutting data are regarded as starting values for the recommended application).
- Possible application. Cutting speed v_c –30%, with compressed air or MQL (minimum quantity lubrication).

The specified cutting data are average recommended values.
For special applications, adjustment is recommended.

Insert geometry							Cutting material grade															
Starting values for feed f [mm/U]							Starting values for cutting speed v _c [m/min]															
– PF2 / – PM2			– PF4 / – PS5				HC									HW						
D _c [mm]			D _c [mm]				WAK10			WAK20			WAK30			WXN10			WK1			
<44	>44-73	>73	<44	>44-73	>73		f [mm/U]			f [mm/U]			f [mm/U]			f [mm/U]			f [mm/U]			
						0,1	0,2	0,4	0,1	0,2	0,4	0,1	0,2	0,4	0,1	0,2	0,4	0,1	0,2	0,4		
			0,16	0,24	0,32																	
			0,13	0,19	0,32																	
			0,12	0,18	0,28																	
			0,11	0,16	0,24																	
			0,10	0,14	0,20																	
			0,12	0,18	0,28																	
			0,16	0,24	0,32																	
			0,11	0,16	0,24																	
			0,10	0,14	0,20																	
			0,08	0,12	0,16																	
			0,11	0,16	0,24																	
			0,11	0,16	0,24																	
			0,08	0,12	0,16																	
			0,10	0,13	0,19																	
			0,10	0,13	0,19																	
			0,10	0,13	0,19																	
			0,14	0,22	0,30	280	250	210	210	190	180	140	125	110								
			0,13	0,19	0,24	220	200	150	170	150	110	120	100	70								
			0,16	0,24	0,32	390	350	260	350	320	200	310	290	140								
			0,13	0,19	0,24	250	220	170	190	170	130	130	120	90								
			0,16	0,24	0,32	260	230	190	200	180	150	140	130	110								
			0,13	0,19	0,24	190	170	150	150	130	110	110	90	70								
			0,14	0,22	0,30	190	160	120	160	140	120	120	100	80								
0,24	0,30	0,40													1000*	1000*	1000*	1000*	1000*			
0,24	0,30	0,40													900	900	900	800	800			
0,24	0,30	0,40													500	500	500	500	500	500	500	
0,24	0,30	0,40													400	400	400	400	400	400	400	
0,24	0,30	0,40													300	300	300	300	300	300	300	
0,24	0,30	0,40													500	500	500	500	500	500	500	
0,24	0,30	0,40	0,13	0,19	0,32										450	400	350	450	400	350		
0,24	0,30	0,40	0,13	0,19	0,32										400	350	300	400	350	300		
0,24	0,30	0,40	0,13	0,19	0,32										350	300	250	350	300	250		
			0,08	0,12	0,16																	
			0,08	0,12	0,16																	
			0,08	0,12	0,16																	
			0,08	0,12	0,16																	
			0,11	0,13	0,19														45	45		
			0,09	0,11	0,16														40	40		

HC = Coated carbide
HW = Uncoated carbide

* Observe limit speeds.

Cutting data for precision boring

Material group	Structure of main material groups and code letters		Brinell hardness HB	Tensile strength R _m N/mm ²	Machining group ¹		Starting values for cutting speed v _c [m/min]						
							HC WPP01 / WPP10						
							L/D						
			3 x D _c	4 x D _c	6 x D _c								
P	Non-alloyed steel	C ≤ 0.25%	annealed	125	428	P1	●●		355	320	195		
		C > 0.25 ... ≤ 0.55%	annealed	190	639	P2	●●		335	265	160		
		C > 0.25 ... ≤ 0.55%	tempered	210	708	P3	●●		300	240	150		
		C > 0.55%	annealed	190	639	P4	●●		290	230	140		
		C > 0.55%	tempered	300	1013	P5	●●		255	205	125		
		machining steel (short-chipping)	annealed	220	745	P6	●●	●	300	240	150		
	Low-alloyed steel		annealed	175	591	P7	●●		330	265	160		
			tempered	300	1013	P8	●●		275	220	140		
			tempered	380	1282	P9	●●		245	195	115		
			tempered	430	1477	P10	●●		200	160	80		
	High-alloyed steel and high-alloyed tool steel		annealed	200	675	P11	●●		275	220	140		
			hardened and tempered	300	1013	P12	●●		230	195	115		
			hardened and tempered	400	1361	P13	●●		210	170	90		
	Stainless steel		ferritic/martensitic, annealed	200	675	P14	●●		275	205	140		
			martensitic, tempered	330	1114	P15	●●		210	180	100		
M	Stainless steel		austenitic, quench hardened	200	675	M1	●●						
			austenitic, precipitation hardened (PH)	300	1013	M2	●●						
			austenitic/ferritic, duplex	230	778	M3	●●						
K	Malleable cast iron		ferritic	200	675	K1	●●	●	280	235	130		
			pearlitic	260	867	K2	●●	●	220	185	115		
	Grey cast iron		low tensile strength	180	602	K3	●●	●	300	255	150		
			high tensile strength/austenitic	245	825	K4	●●	●	220	185	115		
	Cast iron with spheroidal graphite		ferritic	155	518	K5	●●		275	220	140		
			pearlitic	265	885	K6	●●		255	195	125		
		GGV (CGI)		200	675	K7	●●		235	175	105		
N	Aluminium wrought alloys		cannot be hardened	30	-	N1	●●						
			hardenable, hardened	100	343	N2	●●						
	Cast aluminium alloys		≤ 12% Si, cannot be hardened	75	260	N3	●●						
			≤ 12% Si, hardenable, hardened	90	314	N4	●●						
			> 12% Si, cannot be hardened	130	447	N5	●●						
	Magnesium alloys			70	250	N6	●●						
		Copper and copper alloys (bronze/brass)		non-alloyed, electrolytic copper	100	343	N7	●●		285	230		
			brass, bronze, red brass	90	314	N8	●●		345	275			
	Cu-alloys, short-chipping		110	382	N9	●●							
	high-strength, Ampco	300	1013	N10									
S	Heat-resistant alloys	Fe-based		annealed	200	675	S1	●●					
				hardened	280	943	S2	●●					
		Ni or Co base		annealed	250	839	S3	●●					
				hardened	350	1177	S4	●●					
				cast	320	1076	S5	●●					
	Titanium alloys		pure titanium	200	675	S6							
			α and β alloys, hardened	375	1262	S7	●●						
	β alloys	410	1396	S8	●●								
Tungsten alloys			300	1013	S9								
Molybdenum alloys			300	1013	S10								
H	Hardened steel		hardened and tempered	50 HRC	-	H1	●●	●					
			hardened and tempered	55 HRC	-	H2	●●	●					
			hardened and tempered	60 HRC	-	H3	●●	●					
	Hardened cast iron		hardened and tempered	55 HRC	-	H4	●●						
O	Thermoplasts		without abrasive fillers			O1							
	Thermosetting plastics		without abrasive fillers			O2							
	Plastic, glass fibre reinforced		GFRP			O3							
	Plastic, carbon fibre reinforced		CFRP			O4							
	Plastic, aramid fibre reinforced		AFRP			O5							
	Graphite (technical)			80 Shore			O6						

¹The classification of the machining groups can be found in the Walter General catalogue 2012 from page H 8 onwards.

- Recommended application (the specified cutting data are regarded as starting values for the recommended application).
- Possible application. MQL (minimum quantity lubrication) or compressed air is recommended.

The specified cutting data are average recommended values.
For special applications, adjustment is recommended.

Starting values for cutting speed v_c [m/min]																						
HC																						
WPP20 / WPP30			WTP35			WSM10			WSM20 / WSM30			WAK10 / WAK15			WXN10			WXM15				
L/D			L/D			L/D			L/D			L/D			L/D			L/D				
3 x D _c	4 x D _c	6 x D _c	3 x D _c	4 x D _c	6 x D _c	3 x D _c	4 x D _c	6 x D _c	3 x D _c	4 x D _c	6 x D _c	3 x D _c	4 x D _c	6 x D _c	3 x D _c	4 x D _c	6 x D _c	3 x D _c	4 x D _c	6 x D _c		
310	280	170	260	210	130							310	280	170				260	210	130		
290	230	140	220	180	110							290	230	140				220	180	110		
260	210	130	200	160	100							260	210	130				200	160	100		
250	200	120	190	150	90							250	200	120				190	150	90		
220	180	110	140	110	70							220	180	110				140	110	70		
260	210	130	200	160	100							260	210	130				200	160	100		
290	230	140	220	170	110							290	230	140				220	170	110		
240	190	120	180	150	90							240	190	120				180	150	90		
210	170	100	130	100	60							210	170	100				130	100	60		
180	140	70	100	75	50							180	140	70				100	75	50		
240	180	120	180	150	90							240	180	120				180	150	90		
200	170	100	160	130	80							200	170	100				160	130	80		
190	150	80	110	85	60							190	150	80				110	85	60		
240	190	120	160	130	80							240	190	120				160	130	80		
180	160	90	150	120	70							180	160	80				150	120	70		
220	170	110	200	160	100	220	170	110	200	160	100	240	190					200	160	100		
160	120	100	150	110	80	160	120	100	150	110	90	190	140					150	110	60		
180	140	80	180	140	100	180	140	90	170	130	80	220	170					180	140	80		
240	200	110	180	140	80							240	200	110				180	140	80		
190	160	100	160	130	80							190	160	100				160	130	80		
260	220	130	220	160	100							260	220	130				200	160	100		
190	160	100	160	130	80							190	160	100				160	130	80		
240	190	120	180	140	90							240	190	120				180	140	90		
220	170	110	160	130	80							220	170	110				160	130	80		
												200	150	100								
			600	480	330										940	750	500	600	480	330		
			500	400	280										750	600	410	500	400	280		
			500	400	280										750	600	410	500	400	280		
			400	320	220										560	450	310	400	320	220		
			300	250	200										440	440	250	300	250	200		
			450	350	250										700	550	350	450	350	250		
			350	280	180										380	300	210	350	280	180		
250	200								250	200		250	200		310	230	160					
300	240								300	240		300	240		380	280	210					
80	60	40				90	70	50	80	60	40	80	60	40								
70	50	35				80	60	45	70	50	35	70	50	35								
70	50	35				80	60	45	70	50	35	70	50	35								
50	40	25				60	50	35	50	40	25	50	40	25								
50	40	25				60	50	35	50	40	25	50	40	25								
						60	50	40	50	40	30											

HC = Coated carbide

Cutting data for precision boring

Material group	Structure of main material groups and code letters		Brinell hardness HB	Tensile strength R _m N/mm ²	Machining group ¹			Starting values for cutting speed v _c (m/min)			
								HW			
								WK1			
			L/D								
			3 x D _c	4 x D _c	6 x D _c						
P	Non-alloyed steel	C ≤ 0.25%	annealed	125	428	P1	●●				
		C > 0.25 ... ≤ 0.55%	annealed	190	639	P2	●●				
		C > 0.25 ... ≤ 0.55%	tempered	210	708	P3	●●				
		C > 0.55%	annealed	190	639	P4	●●				
		C > 0.55%	tempered	300	1013	P5	●●				
		machining steel (short-chipping)	annealed	220	745	P6	●●	●			
	Low-alloyed steel		annealed	175	591	P7	●●				
			tempered	300	1013	P8	●●				
			tempered	380	1282	P9	●●				
			tempered	430	1477	P10	●●				
	High-alloyed steel and high-alloyed tool steel		annealed	200	675	P11	●●				
			hardened and tempered	300	1013	P12	●●				
			hardened and tempered	400	1361	P13	●●				
	Stainless steel		ferritic/martensitic, annealed	200	675	P14	●●				
			martensitic, tempered	330	1114	P15	●●				
M	Stainless steel	austenitic, quench hardened	200	675	M1	●●					
		austenitic, precipitation hardened (PH)	300	1013	M2	●●					
		austenitic/ferritic, duplex	230	778	M3	●●					
K	Malleable cast iron	ferritic	200	675	K1	●●	●	160	120	90	
		pearlitic	260	867	K2	●●	●	150	120	90	
	Grey cast iron	low tensile strength	180	602	K3	●●	●	210	170	120	
		high tensile strength/austenitic	245	825	K4	●●	●	150	120	90	
	Cast iron with spheroidal graphite	ferritic	155	518	K5	●●		170	140	100	
		pearlitic	265	885	K6	●●		140	110	70	
	GGV (CGI)		200	675	K7	●●					
N	Aluminium wrought alloys	cannot be hardened	30	-	N1	●●		750	600	400	
		hardenable, hardened	100	343	N2	●●		600	480	330	
	Cast aluminium alloys	≤ 12% Si, cannot be hardened	75	260	N3	●●		600	480	330	
		≤ 12% Si, hardenable, hardened	90	314	N4	●●		450	360	250	
		> 12% Si, cannot be hardened	130	447	N5	●●		350	350	200	
	Magnesium alloys		70	250	N6	●●		550	450	300	
	Copper and copper alloys (bronze/brass)	non-alloyed, electrolytic copper	100	343	N7	●●		300	240	170	
		brass, bronze, red brass	90	314	N8	●●		250	180	130	
		Cu-alloys, short-chipping	110	382	N9	●●		300	240	170	
		high-strength, Ampco	300	1013	N10						
S	Heat-resistant alloys	Fe-based	annealed	200	675	S1	●●				
			hardened	280	943	S2	●●				
		Ni or Co base	annealed	250	839	S3	●●				
			hardened	350	1177	S4	●●				
			cast	320	1076	S5	●●				
	Titanium alloys	pure titanium	200	675	S6						
		α and β alloys, hardened	375	1262	S7	●●					
		β alloys	410	1396	S8	●●					
	Tungsten alloys		300	1013	S9						
	Molybdenum alloys		300	1013	S10						
H	Hardened steel	hardened and tempered	50 HRC	-	H1	●●	●				
		hardened and tempered	55 HRC	-	H2	●●	●				
		hardened and tempered	60 HRC	-	H3	●●	●				
	Hardened cast iron	hardened and tempered	55 HRC	-	H4	●●					
O	Thermoplasts	without abrasive fillers			O1						
	Thermosetting plastics	without abrasive fillers			O2						
	Plastic, glass fibre reinforced	GFRP			O3						
	Plastic, carbon fibre reinforced	CFRP			O4						
	Plastic, aramid fibre reinforced	AFRP			O5						
	Graphite (technical)		80 Shore		O6						

¹The classification of the machining groups can be found in the Walter General catalogue 2012 from page H 8 onwards.

- Recommended application (the specified cutting data are regarded as starting values for the recommended application).
- Possible application. MQL (minimum quantity lubrication) or compressed air is recommended.

Cutting tool material application tables – Drilling

Grades for drilling																				
Walter grade designation	Standard designation	Workpiece material group							Application range							Coating process	Coating composition	Indexable insert example		
		P	M	K	N	S	H	O	01	05	10	15	20	25	30				35	40
		Steel	Stainless steel	Cast iron	NF metals	Difficult-to-machine materials	Hard materials	Other												
WAP20	HC – P 20	●●																CVD	TiCN + Al ₂ O ₃ + TiN	
	HC – K 30			●																
WKP25S	HC – P 25	●●																CVD	TiCN + Al ₂ O ₃ (+TiN)	
	HC – K 25			●●																
WKP35S	HC – P 35	●●																CVD	TiCN + Al ₂ O ₃ (+TiN)	
	HC – K 35			●●																
WMP35	HC – P 35	●●																PVD	TiAlN	
	HC – M 35		●●																	
	HC – S 35					●●														
WSP45	HC – P 45	●●																PVD	TiAlN + Al ₂ O ₃ (+ZrN)	
	HC – M 45		●●																	
	HC – S 45					●●														
WTP35	HC – P 35	●●																PVD	TiCN + TiN	
	HC – M 35		●																	
	HC – S 35					●														
WXP45	HC – P 45	●●																PVD	Multilayer TiAlN / TiN	
	HC – K 45			●																
WAK15	HC – K 15			●●														CVD	TiCN + Al ₂ O ₃ (+TiN)	
WXK25	HC – K 25			●●														PVD	Multilayer TiAlN / TiN	
	HC – P 15	●																		
WXP40	HC – P 40	●●																PVD	TiCN	
	HC – M 30		●●																	
	HC – S 30					●														
WNN25	HC – N 25				●●													PVD	ta-C (DLC)	
	HC – O 25						●													
WPP45C	HC – P 45	●●																PVD	TiAlN / TiAl	
	HC – K 45			●																

HC = Coated carbide
HW = Uncoated carbide

- Primary application
- Other application

Cutting tool material application tables – Boring

Grades for counterboring and precision boring																				
Walter grade designation	Standard designation	Workpiece material group							Application range							Coating process	Coating composition	Indexable insert example		
		P	M	K	N	S	H	O	01	05	10	15	20	25	30				35	40
		Steel	Stainless steel	Cast iron	NF metals	Difficult-to-machine materials	Hard materials	Other												
WPP01	HC – P 01	●●							[Application range diagram]							CVD	TiCN + Al ₂ O ₃ (+TiN)			
	HC – K 10			●					[Application range diagram]											
WPP10	HC – P 10	●●							[Application range diagram]							CVD	TiCN + Al ₂ O ₃ (+TiN)			
	HC – K 20			●					[Application range diagram]											
WPP20	HC – P 20	●●							[Application range diagram]							CVD	TiCN + Al ₂ O ₃ (+TiN)			
	HC – K 30			●					[Application range diagram]											
WPP30	HC – P 30	●●							[Application range diagram]							CVD	TiCN + Al ₂ O ₃ (+TiN)			
WXM15	HC – P 15	●●							[Application range diagram]							PVD	Multilayer TiAlN / TiN			
	HC – M 15		●						[Application range diagram]											
	HC – K 15			●					[Application range diagram]											
WTP35	HC – P 35	●●							[Application range diagram]							CVD	TiCN + TiN			
	HC – M 35		●						[Application range diagram]											
	HC – S 35					●			[Application range diagram]											
WSM10	HC – M 10		●●						[Application range diagram]							PVD	TiAlN + Al ₂ O ₃ (ZrCN)			
	HC – S 10					●●			[Application range diagram]											
	HC – P 10	●							[Application range diagram]											
WSM20	HC – M 20		●●						[Application range diagram]							PVD	TiAlN + Al ₂ O ₃ (ZrCN)			
	HC – S 20					●●			[Application range diagram]											
	HC – P 20	●							[Application range diagram]											
WSM30	HC – M 30		●●						[Application range diagram]							PVD	TiAlN + Al ₂ O ₃ (ZrCN)			
	HC – S 30					●●			[Application range diagram]											
	HC – P 30	●							[Application range diagram]											
WAK10	HC – K 10			●●					[Application range diagram]							CVD	TiCN + Al ₂ O ₃ (+TiN)			
	HC – H 30						●		[Application range diagram]											
WAK15	HC – K 15			●●					[Application range diagram]							CVD	TiCN + Al ₂ O ₃ (+TiN)			
WAK20	HC – K 20			●●					[Application range diagram]							CVD	TiCN + Al ₂ O ₃ (+TiN)			
	HC – P 10	●							[Application range diagram]											
WAK30	HC – K 30			●●					[Application range diagram]							CVD	TiCN + Al ₂ O ₃ (+TiN)			
	HC – P 40	●							[Application range diagram]											

BL = CBN with low CBN content
 BH = CBN with high CBN content
 DP = Polycrystalline Diamond
 HC = Coated carbide
 HW = Uncoated carbide
 HT = Cermet
 ●● Primary application
 ● Other application

Cutting tool material application tables – Boring and reaming

Grades for counterboring and precision boring (continued)

Walter grade designation	Standard designation	Workpiece material group							Application range									Coating composition	Indexable insert example	
		P	M	K	N	S	H	O	01	05	10	15	20	25	30	35	40			45
WXN10	HC – N 10				●●														TiCN ^{plus}	
	HC – M 01		●																	
WK1	HW – N 10				●●														—	
WCB30	BL – H 05							●●											—	
WCB50	BH – H 10							●●											—	
	BH – K 10			●															—	
WCB80	BH – K 05			●●															—	
	BH – H 15							●											—	
WCD10	DP – N 10				●●														—	

BL = CBN with low CBN content
 BH = CBN with high CBN content
 DP = Polycrystalline Diamond
 HC = Coated carbide
 HW = Uncoated carbide
 HT = Cermet

●● Primary application
 ● Other application







Grades for reaming

Walter grade designation	Standard designation	Workpiece material group							Application range									Coating process	Coating composition	Indexable insert example	
		P	M	K	N	S	H	O	01	05	10	15	20	25	30	35	40				45
WXP15	HC – P 15	●●																	PVD	TiN	
	HC – M 15		●●																		
	HC – K 15			●●																	
WK10	HW – N 10	●		●	●●														—	—	
WCE10	HT – P 15	●●																	—	—	
WXK05	HC – K 05	●	●	●●				●											—	—	

BL = CBN with low CBN content
 BH = CBN with high CBN content
 DP = Polycrystalline Diamond
 HC = Coated carbide
 HW = Uncoated carbide
 HT = Cermet

●● Primary application
 ● Other application









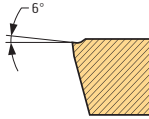

Geometry overview of indexable inserts for drilling

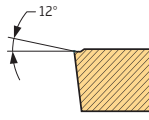
Drilling		Workpiece material group								
		P	M	K	N	S	H	O		
Geometry	Remarks on field of applications	Steel	Stainless steel	Cast iron	NF metals	Difficult-to-machine materials	Hard materials	Other		
	A57 – The stable one – 0° rake angle – For unfavourable machining conditions mainly for cast iron and steel materials	••	•	••		•				
	E57 – The universal one – 13° rake angle – For medium machining conditions – For cast iron and steel, but also for stainless and difficult-to-cut materials	••	••	••	•	•				
	E67 – The special one – 13° rake angle – Special geometry for optimum chip formation – For long-chipping materials, e.g. St37, stainless and also difficult-to-cut materials and aluminium	••	••		•	••				
	P6001 – The universal one – Universal use on ISO P, steels with low to medium tensile strength (up to $R_m = 900 \text{ N/mm}^2$) – Universal geometry for high chip removal and long tool life	••		•						
	P6002 – The stable one – Designed for ISO K – With stable facet			••						
	P6003 – The special one – For best results in ISO M and ISO S – Sharp cutting edge – Rounded cutting edges near to the centre	•	••			••				
	P6004 – The sharp one – For best results in ISO N (aluminium) – Extremely smooth surface – Sharp cutting edge				••					

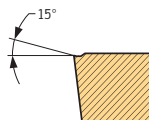

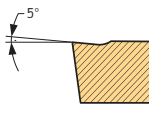

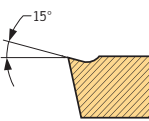

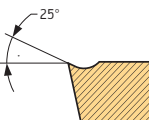



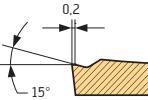
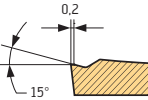

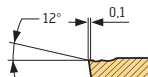
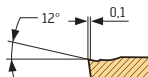

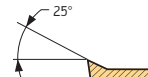
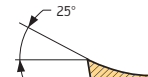
•• Primary application
 • Other application

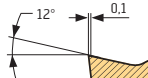
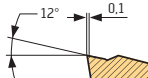
Geometry overview of indexable inserts for drilling

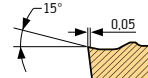
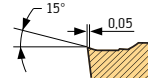
Drilling (continued)

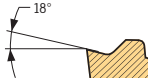
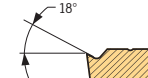
Geometry	Remarks/field of applications	Workpiece material group							Section Main cutting edge	a _p [mm]	f [mm]	
		P	M	K	N	S	H	O				
		Steel	Stainless steel	Cast iron	NF metals	Difficult-to-machine materials	Hard materials	Other				
 <p>LCMX-B57 – The stable one – 6° rake angle – For unfavourable machining conditions – For long-chipping materials</p>		••		••								
 <p>LCMX-D57 – The universal one – 12° rake angle – For medium machining conditions</p>		••	••	••	•	•						
 <p>LCMX-E57 – The easy-cutting one – 15° rake angle – For good machining conditions – Short-chipping materials</p>		••	••		••	••						
Precision boring												
 <p>X5 – The stable one – 5° rake angle – For cast iron and steel materials – For unfavourable machining conditions</p>		••		••						0,1–0,3	0,03–0,15	
 <p>X15 – The universal one – 15° rake angle – For steel, stainless materials and difficult-to-cut materials – Long projection lengths</p>		••	••	•	•	•				0,1–0,3	0,03–0,15	
 <p>X25 – The soft one – 25° rake angle – Aluminium, soft steels, long-chipping materials</p>		••	•		••	•				0,1–0,3	0,03–0,15	
		•• Primary application • Other application										

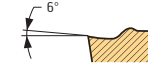
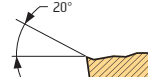
Counterboring/precision boring

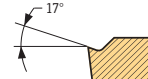
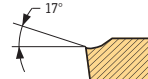
Geometry	Remarks on field of applications	Workpiece material group							Section Main cutting edge	Section Radius	a _p [mm]	f [mm]
		P	M	K	N	S	H	O				
	<p>E47 – The universal one</p> <ul style="list-style-type: none"> – 15° rake angle – Flexible universal geometry for almost all cutting depths – For materials of ISO machining groups P, M, K and S 	●●	●●	●●	●	●●					0,3–6,3	0,07–0,45
	<p>PS5 – Semifinishing</p> <ul style="list-style-type: none"> – Universal insert for semi-machining to medium machining – Can also be used for counterboring 	●●	●●	●●		●				0,16–2,5	0,08–0,32	
	<p>PM2</p> <ul style="list-style-type: none"> – Universal insert for non-ferrous materials – Sharp cutting edge with fully ground circumference – Polished rake face 	●	●		●●	●				0,4–3,0	0,02–0,80	
	<p>PM5</p> <ul style="list-style-type: none"> – Universal insert geometry, medium/roughing operations – Extremely large chip breaking area 	●●	●●	●●		●				0,4–5,0	0,1–0,50	
	<p>PF</p> <ul style="list-style-type: none"> – Finishing with wiper technology – High surface quality – High feed rates <p>Wiper</p>	●●	●●	●●		●				0,30–3,0	0,12–0,60	
	<p>PF2</p> <ul style="list-style-type: none"> – Finishing insert with fully ground circumference – Long, small diameter shafts with vibration tendency – Low cutting forces 	●●	●●	●	●●	●●				0,25–1,6	0,02–0,25	
	<p>PF4</p> <ul style="list-style-type: none"> – Finishing insert – Outstanding chip control – Can also be used for precision boring 	●●	●●			●●				0,15–1,0	0,08–0,30	
	<p>PF5</p> <ul style="list-style-type: none"> – Finishing insert with fully ground circumference – Can also be used for precision boring – Extremely narrow chip breaker groove 	●●	●●			●				0,1–0,8	0,04–0,16	

●● Primary application
● Other application

Application information

Reverse machining for precision boring

For reverse machining, the preset tool must be fed into the drilled hole on an offset axis. Therefore, the boring diameter "D", the diameter of the hole entry "d" and the diameter of the tool body "d1", have a specific ratio to each other.

In order to evaluate the feasibility of reverse machining and select the appropriate tools, these values can be calculated as follows:

Min. diameter of the hole entry "d"

$$d = \frac{D + d_1}{2}$$

Max. boring diameter "D"

$$D = 2d - d_1$$

Max. diameter of the tool body "d1"

$$d_1 = 2d - D$$

Example:

Calculating the minimum diameter of the hole entry "d"

Given:

- Boring diameter $D = 93$ mm
- Tool combination: B3230.C5.55-100.Z1
- Insert holder no. 3, $A = 50$ mm

$$d = \frac{D + d_1}{2} = \frac{93 + 50}{2} = 71,5 \text{ mm}$$

Important:

The anticlockwise spindle must be used for reverse machining.
The cutting edge is set back relative to the boring head. Note the overall length of the tool.
Note the space restrictions on the exit side of the workpiece.

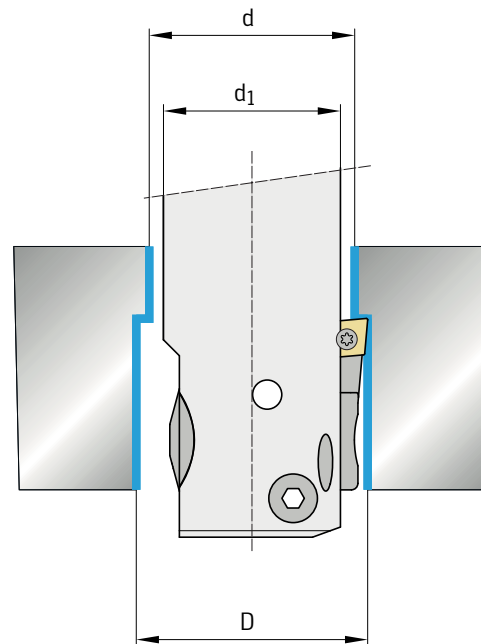

Adjustment range of Walter Boring two flute boring tool B 3220

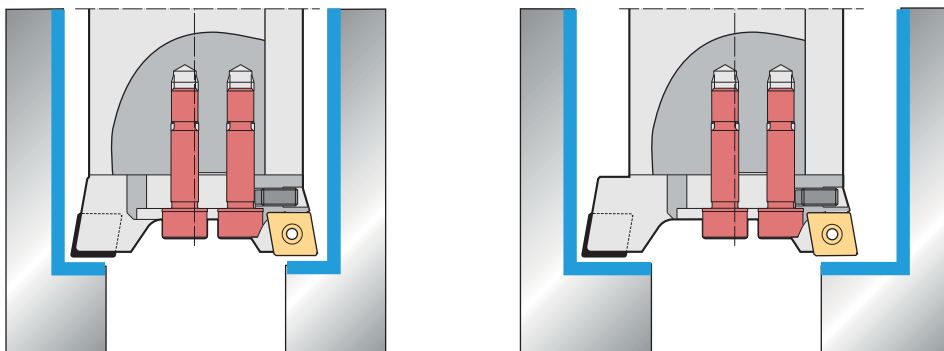

Notes on high-speed cutting

1. Maximum permissible RPM:
The limiting values shown in the tables should not be exceeded. Otherwise correct operation and/or reliability is not guaranteed.
2. Only use original Walter inserts and assembly parts (screws etc.). Recommendation: New screws should be fitted after having replaced the inserts five times at the latest.
3. Adhere to the torques specified in the catalogue.
4. Balancing:
Balancing is required in two steps when milling at high RPM (> 6,000):
 - a. Basic balancing of tool body including inserts (carried out by Walter on request). N.B.: The tool adaptor must also be balanced.
 - b. Fine balancing of the tool when fully mounted on the adaptor. The fine balancing operation is strongly recommended because even the smallest concentricity errors can seriously alter the balance status.
5. Short projection lengths reduce concentricity faults or an imbalance as well as increase spindle life. The specified speeds apply to the use of tools without additional extensions.
6. Safety guards:
Appropriate safety guards or machine enclosures must be used to securely collect particles which spin off, such as chips or cutting edges that are broken as a result of collisions.
7. Damaged tools:
The operating speed must be specified for the repair of HSC Tools. Only Walter may carry out repairs on Walter tools for HSC machining operations.
8. Technical progress:
As research and standardisation on HSC machining operations is ongoing, we reserve the right to make technical changes. The discussion on balancing specifications is still in progress. The results of the "Balancing" study group of the Technical University in Darmstadt show that the quality category G16 is usually sufficient.

1. Walter Boring Counterboring tools B 3220 / B 3221

Diameter range D _C [mm]	n _{max} [1/min]
20–24	16.000
26–33	12.000
33–41	10.000
41–55	7.800
55–70	5.800
70–90	4.600
90–110	3.700
110–153	2.900
150–220	2.100
220–290	1.450
290–360	1.100
360–430	900
430–500	750
500–570	650
570–640	550

The specified limiting speeds refer to symmetrically set tools (Z = 2).
For non-symmetrically set tools (Z = 1), the values are reduced by 50%.

2. Walter Precision Precision boring tools B 3230

Diameter range D _C [mm]	n _{max} [rpm]
2–45,5*	6.000
20–26	12.000
26–33	10.000
33–41	8.100
41–55	6.450
55–70	4.850
70–90	3.835
90–110	3.090
110–153	2.390
150–220	1.440
220–290	1.090
290–360	880
360–430	740
430–500	630
500–570	550
570–640	490

*The boring bar should be positioned as centrally as possible. Use the largest boring bar size possible.

3. Walter Precision Precision boring tools B 4030

Diameter range D _C [mm]	n _{max} [rpm]
2–10*	14.000
10–20*	12.000
20–45*	8.000
33–41	15.000
41–55	11.500
55–70	9.000
70–90	7.000
90–110	5.500
110–153	4.000

4. Walter Precision^{DIGITAL} Precision boring tools B 4035

Diameter range D _C [mm]	n _{max} [rpm]
3–20	16.000
20–32	12.000
32–80	10.000
50–68	8.000
68–96	6.000
96–124	5.000

*The boring bar should be positioned as centrally as possible. Use the largest boring bar size possible.



Threading

	Page	
Walter Prototyp solid carbide, HSS and HSS-E (-PM) threading tools	Walter Select – Tapping	D-2
	Walter Prototyp taps	
	M, MJ	D-16
	MF	D-56
	UNC / UNF / NEF / UN-8	D-76
	G	D-105
	BSW	D-112
	Thread insert taps	D-114
	Walter Select – Thread forming	D-128
	Walter Prototyp M, MF thread formers	D-130
	Walter Select – Thread milling	D-134
Walter Prototyp thread mills	D-136	
Technical Information		
Cutting data	D-140	
Feed tables	D-142	
Coatings and surface treatments	D-143	

Walter Select for threading applications

Step by step to the correct tool

STEP 1

Determine the **material** to be machined from page H 8 in the Walter General catalogue 2012

Note the machining group that corresponds to your material e.g.: P10.

Code letter	Machining group	Groups of the materials to be machined	
P	P1–P15	Steel	All types of steel and cast steel, with the exception of steel with an austenitic structure
M	M1–M3	Stainless steel	Stainless austenitic steel, austenitic-ferritic steel and cast steel
K	K1–K7	Cast iron	Grey cast iron, cast iron with spheroidal graphite, malleable cast iron, cast iron with vermicular graphite
N	N1–N10	NF metals	Aluminium and other non-ferrous metals, non-ferrous materials
S	S1–S10	High temperature alloys and titanium alloys	Heat resisting special alloys based on iron, nickel and cobalt, titanium and titanium alloys
H	H1–H4	Hard materials	Hardened steel, hardened cast iron materials, chilled cast iron
O	O1–O6	Other	Plastics, glass- and carbon-fibre reinforced plastics, graphite

STEP 2

Select your **intended application** from the table.

Thread cutting / tapping Solid carbide / HSS											
	Blind hole					Through hole					
Depth	1,5 × D _N	2,0 × D _N	2,5 × D _N	3,0 × D _N	3,5 × D _N	1,0 × D _N	1,5 × D _N	2,0 × D _N	2,5 × D _N	3,0 × D _N	3,5 × D _N
Solid carbide / page	D-4	D-5	D-5	D-5	D-5	-	D-4	D-5	D-5	D-5	D-5
HSS / page	D-6	D-7	D-9	D-9	D-11	D-12	D-12	D-13	-	D-14	D-15

Thread forming			
	Blind hole		Through hole
Depth	2,0 × D _N		3,0 × D _N
Page	D-128		D-129

Thread milling				
	Inside Blind hole / through hole			Outside
Depth	1,5 × D _N	2,0 × D _N	3,0 × D _N	< 2,0 × D _N
Page	D-134	D-135	D-135	D-135

STEP 3

Select the tool according to the following criteria:

- Material group
- Thread type
- Thread depth

Walter Select – Tapping Blind and through hole machining Solid carbide

WALTER SELECT
 • Primary application
 • Additional application

Type	1,5 x D _N	
	Paradur® N	Prototex® HSC
M	Page D 126*	Page D 71*
MJ		
MF		D 146*
UNC	UNJC	
UNF	UNJF	
UNEF	UN-8	
G		
RC	RP	
NPT	NPSM	
NPTF		
Pg	BSW	
TR		
EG M	EG MF	
EG UNC		
EG UNF		
Coating	uncoated/TiCN	TiCN
Application	GL	DL

BH = Blind hole
TH = Through hole

Material group	Workpiece material	Brinell hardness HB	Tensile strength R _m N/mm ²	Machining group	Image
P	Non-alloyed and low-alloyed steel	annealed (tempered)	210	700	P1, P2, P3, P4, P7
		free cutting steel	220	750	P6
		tempered	300	1010	P5, P8
		tempered	380	1280	P9
		tempered	430	1480	P10
P	High-alloyed steel and high-alloyed tool steel	annealed	200	670	P11
		hardened and tempered	300	1010	P12
		hardened and tempered	400	1360	P13
M	Stainless steel	ferritic/martensitic, annealed	200	670	P14
		martensitic, tempered	330	1110	P15
	Stainless steel	austenitic, duplex	230	780	M1, M3
K	Grey cast iron	austenitic, precipitation hardened (PH)	300	1010	M2
	Cast iron		245		

STEP 4

The corresponding page in the catalogue is specified following tool selection.

On the bottom right of the catalogue page, you will find a reference to the cutting data table.

Thread tapping

Machine tap Prototex® X-pert P

≤3xD_N

- HSS-E
- Chamfer form B = 3.5 - 5 thread
- Materials from 200 to 1000 N/mm² or 32 HRC
- For long-chipping materials

	P	M	K	N	S	H	O
uncoated	●●	●●	●●	●●	●●	●●	●●
TiN	●●	●●	●●	●●	●●	●●	●●

MF
DIN 13

DIN 374	ISO2/6H	D _N	P mm	l ₁ js16 mm	L _c mm	d ₁ h9 mm	□ h12 mm	l ₂ mm	N	uncoated Designation P21360	TiN Designation P2136005
M 4		0,5	63	12	2,8	2,1	5	3	3	★ -M4X0,5	★ -M4X0,5
M 5		0,5	70	13	3,5	2,7	6	3	3	★ -M5X0,5	★ -M5X0,5
M 6		0,5	80	15	4,5	3,4	6	3	3	★ -M6X0,5	★ -M6X0,5
M 6		0,75	80	15	4,5	3,4	6	3	3	★ -M6X0,75	★ -M6X0,75
M 8		0,5	80	15	6	4,9	8	3	3	★ -M8X0,5	★ -M8X0,5
M 8		0,75	80	15	6	4,9	8	3	3	★ -M8X0,75	★ -M8X0,75

STEP 5

Select the cutting data for the tool type from page D-140 onwards.

Cutting data for thread tapping, thread forming, thread milling and drill thread milling

Material group	Grouping of main material groups and code letters	Brinell hardness HB	Tensile strength R _m N/mm ²	Machining group	Taps					
					Solid carbide coated	HSS-E (-PM) uncoated	HSS-E (-PM) coated			
P	Non-alloyed steel	C ≤ 0.25%	annealed	125	428	P1	15	30	E	
		C > 0.25% ≤ 0.55%	annealed	190	639	P2	15	30	E	
		C > 0.25% ≤ 0.55%	tempered	210	708	P3	12,5	25	E	
		C > 0.55%	annealed	190	639	P4	15	30	E	
		C > 0.55%	tempered	300	1013	P5	45	7,5	15	E
		Free cutting steel (short-chipping)	annealed	220	745	P6	15	30	E	
P	Low-alloyed steel	annealed	175	591	P7	15	30	E		
		tempered	300	1013	P8	50	7,5	15	E	
		tempered	380	1282	P9	35	4	7,5	E	
		tempered	430	1477	P10	20	2	4	O	
		tempered	200	675	P11	15	15	30	E	
P	High-alloyed steel and high-alloyed tool steel	annealed	200	675	P11	15	15	30	E	
		hardened and tempered	300	1013	P12	50	7,5	15	E	
		hardened and tempered	400	1361	P13	30	3	6	O	
M	Stainless steel	ferritic/martensitic, annealed	200	675	P14	5	10	E		
		martensitic, tempered	330	1114	P15	2	4	E		
M	Stainless steel	austenitic, quench hardened	200	675	M1	5	10	E		
		austenitic, precipitation hardened (PH)	300	1013	M2	3	6	E		
		austenitic, precipitation hardened (PH)	230	778	M3	3	8	E		

Walter Select – Tapping

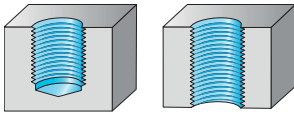

Blind and through hole machining

Solid carbide









BH = Blind hole
TH = Through hole

Thread depth	1,5 x D _N	
	Paradur® N	Prototex® HSC
Type	Page	Page
M	<i>D 126*</i>	<i>D 71*</i>
MJ		
MF		<i>D 146*</i>
UNC	UNJC	
UNF	UNJF	
UNEF	UN-8	
G		
RC	RP	
NPT	NPSM	
NPTF		
Pg	BSW	
TR		
EG M	EG MF	
EG UNC		
EG UNF		
Coating	uncoated/TICN	TICN
Application	GL	DL

Material group	Grouping of main material groups and code letters		Brinell hardness HB	Tensile strength R _m N/mm ²	Machining group			
	Workpiece material							
P	Non-alloyed and low-alloyed steel	annealed (tempered)	210	700	P1, P2, P3, P4, P7			
		free cutting steel	220	750	P6			
		tempered	300	1010	P5, P8	•		
		tempered	380	1280	P9	••		
		tempered	430	1480	P10	•		
	High-alloyed steel and high-alloyed tool steel	annealed	200	670	P11			
		hardened and tempered	300	1010	P12	••		
hardened and tempered		400	1360	P13	•			
Stainless steel	ferritic/martensitic, annealed	200	670	P14				
	martensitic, tempered	330	1110	P15				
M	Stainless steel	austenitic, duplex	230	780	M1, M3			
		austenitic, precipitation hardened (PH)	300	1010	M2			
K	Grey cast iron		245	–	K3, K4	•	•	
	Cast iron with spheroidal graphite GGV (CGI)	ferritic, pearlitic	365	–	K1, K2, K5, K6	••	••	
			200	–	K7	•	•	
N	Aluminium wrought alloys	cannot be hardened	30	–	N1			
		hardenable, hardened	100	340	N2			
	Cast aluminium alloys	≤ 12% Si	90	310	N3, N4	••		
		> 12% Si	130	450	N5	•		
	Magnesium alloys		70	250	N6	••		
	Copper and copper alloys (bronze/brass)	non-alloyed, electrolytic copper	100	340	N7			
		brass, bronze, red brass	90	310	N8			
Cu-alloys, short-chipping		110	380	N9				
high-strength, Ampco		300	1010	N10				
S	Heat-resistant alloys	Fe-based	280	940	S1, S2			
		Ni or Co base	250	840	S3			
		Ni or Co base	350	1080	S4, S5			
	Titanium alloys	pure titanium	200	670	S6			
		α and β alloys, hardened	375	1260	S7			
		β alloys	410	1400	S8			
	Tungsten alloys		300	1010	S9			
	Molybdenum alloys		300	1010	S10			
	H	Hardened steel		50 HRC	–	H1		
				55 HRC	–	H2, H4		
			60 HRC	–	H3			
O	Thermoplasts	without abrasive fillers			O1			
	Thermosetting plastics	without abrasive fillers			O2	•		
	Plastic, fibre-reinforced	GFRP, AFRP			O3, O5	•		
		CFRP			O4	•		
Graphite (technical)			65		O6			

* The pages indicated in italics refer to the Walter General catalogue 2012.

	2,0 x D _N				3,0 x D _N		3,5 x D _N
	Paradur® HSC	Paradur® Hard	Paradur® Hard Plus	Paradur® Hard Scraper	Paradur® Engine	Paradur® HS	Paradur® GG
	Page	Page	Page	Page	Page	Page	Page
	<i>D 125*</i>	<i>D 132*</i>	<i>D 133*</i>		<i>D 129*</i>	<i>D 130*</i>	<i>D 128*</i>
	<i>D 175*</i>				<i>D 177*</i>	<i>D 178*</i> <i>D 201*</i> <i>D 231*</i>	<i>D 176*</i>
				<i>D 248*</i>			
	TiCN GL	TiCN GL+DL	TiCN GL+DL	TiCN GL+DL	uncoated GL	uncoated/TiCN GL+DL	uncoated/TAFT GL+DL
							
	••						
	••						
	••						
	••						
	••						
	•				••	•	••
	••				••	•	••
	•				••	•	••
	•				••	•	•
	••				••	••	•
	•				•	••	•
						•	
		•	•	•		•	
		•	•	•		•	
	••	••	••	••		•	
	••	••	••	••			
						••	
						••	
						••	
							••

Walter Select – Tapping

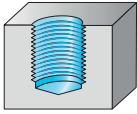

Blind hole machining

HSS-E (-PM)



BH = Blind hole
TH = Through hole

Thread depth		1,5 x D _N	
Type		Paradur® H	Paradur® N
		Page	Page
M		<i>D 78*</i>	<i>D 83*</i>
MJ			
MF		<i>D 150*</i>	<i>D 156*</i>
UNC	UNJC		<i>D 189*</i>
UNF	UNJF		<i>D 215*</i>
UNEF	UN-8		
G		<i>D 238*</i>	<i>D 239*</i>
RC	RP	<i>D 249* / D 250*</i>	
NPT	NPSM	<i>D 251*</i>	<i>D 252*</i>
NPTF		<i>D 256*</i>	<i>D 257*</i>
Pg	BSW		
TR			
EG M	EG MF		
EG UNC			
EG UNF			
Coating		uncoated/ TiN	uncoated/ TiN/TiCN
Application		GL/DL	GL

Material group	Grouping of main material groups and code letters		Birmell hardness HB	Tensile strength R _m N/mm ²	Machining group			
	Workpiece material							
P	Non-alloyed and low-alloyed steel	annealed (tempered)	210	700	P1, P2, P3, P4, P7		●●	
		free cutting steel	220	750	P6		●●	
		tempered	300	1010	P5, P8			
		tempered	380	1280	P9			
		tempered	430	1480	P10			
	High-alloyed steel and high-alloyed tool steel	annealed	200	670	P11			
		hardened and tempered	300	1010	P12			
		hardened and tempered	400	1360	P13			
	Stainless steel	ferritic/martensitic, annealed	200	670	P14			
		martensitic, tempered	330	1110	P15			
M	Stainless steel	austenitic, duplex	230	780	M1, M3			
		austenitic, precipitation hardened (PH)	300	1010	M2			
	Grey cast iron		245	–	K3, K4			
K	Cast iron with spheroidal graphite	ferritic, pearlitic	365	–	K1, K2, K5, K6	●	●●	
	GGV (CGI)		200	–	K7			
N	Aluminium wrought alloys	cannot be hardened	30	–	N1		●●	
		hardenable, hardened	100	340	N2	●	●●	
	Cast aluminium alloys	≤ 12% Si	90	310	N3, N4	●	●●	
		> 12% Si	130	450	N5	●	●	
	Magnesium alloys		70	250	N6	●	●●	
	Copper and copper alloys (bronze/brass)	non-alloyed, electrolytic copper	100	340	N7			
		brass, bronze, red brass	90	310	N8	●	●	
Cu-alloys, short-chipping		110	380	N9	●	●		
	high-strength, Ampco	300	1010	N10				
S	Heat-resistant alloys	Fe-based	280	940	S1, S2			
		Ni or Co base	250	840	S3			
		Ni or Co base	350	1080	S4, S5			
	Titanium alloys	pure titanium	200	670	S6			
		α and β alloys, hardened	375	1260	S7			
		β alloys	410	1400	S8			
Tungsten alloys		300	1010	S9				
Molybdenum alloys		300	1010	S10				
H	Hardened steel		50 HRC	–	H1			
			55 HRC	–	H2, H4			
			60 HRC	–	H3			
O	Thermoplasts	without abrasive fillers			O1			
	Thermosetting plastics	without abrasive fillers			O2	●		
	Plastic, fibre-reinforced	GFRP, AFRP			O3, O5	●		
		CFRP			O4	●		
Graphite (technical)			65	O6	●			

* The pages indicated in italics refer to the Walter General catalogue 2012.

	1,5 x D _N				2,0 x D _N				
	Paradur Inox® 25	Paradur Inox® 40	Paradur® Ni	Paradur® Ni 10	Paradur® AP	Paradur® Ti	Paradur® Ti plus	Paradur® FT	HGB
	Page	Page	Page	Page	Page	Page	Page	Page	Page
	D 103*		D 117*	D 119*	D 116*	D 121*	D 123*	D 124*	D 60*
				D 120*		D 122*			
	D 166*			D 172*		D 173*	D 174*		
			D 196*	D 198*		D 199*			
			D 222*	D 223*		D 224*	D 226*		
	D 243*								
		D 254*	D 253*						
			D 270*						
			D 285*						
	TiN	uncoated	uncoated	uncoated / TiN	nit	uncoated/ TiCN	ACN	uncoated	uncoated
	GL	GL/DL	GL	GL	GL/DL	GL	GL	GL/DL	GL/DL
		•							•
	••	•••		•		••			•
		•		••		•			
	••	••	•	••		••			
	••	••				••			
	••	••				••			
	••	••							
		•							•
									•
									•
									•
									•
									•
					••				•
			••	•		•		•	
			•	••		•	••	•	
			•	••		•	••	•	
								•	
								•	
								•	

Walter Select – Tapping

Blind hole machining

HSS-E (-PM)

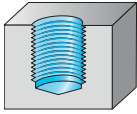

BH = Blind hole
TH = Through hole

i = only for synchronous machining

Thread depth	2,0 x D _N	
Type	HGB Inox	HGB Ti
	Page	Page
M	<i>D 61*</i>	<i>D 62*</i>
MJ		
MF		
UNC	UNJC	
UNF	UNJF	
UNEF	UN-8	
G		
RC	RP	
NPT	NPSM	
NPTF		
Pg	BSW	
TR		
EG M	EG MF	
EG UNC		
EG UNF		
Coating	vap	nid
Application	GL/DL	GL/DL

Material group	Grouping of main material groups and code letters		Brinell hardness HB	Tensile strength R _m N/mm ²	Machining group	2,0 x D _N	
	Workpiece material					vap	nid
P	Non-alloyed and low-alloyed steel	annealed (tempered)	210	700	P1, P2, P3, P4, P7		
		free cutting steel	220	750	P6		
		tempered	300	1010	P5, P8		
		tempered	380	1280	P9		
		tempered	430	1480	P10		
	High-alloyed steel and high-alloyed tool steel	annealed	200	670	P11		
		hardened and tempered	300	1010	P12		
hardened and tempered		400	1360	P13			
Stainless steel	ferritic/martensitic, annealed	200	670	P14	●		
	martensitic, tempered	330	1110	P15	●		
M	Stainless steel	austenitic, duplex	230	780	M1, M3	●	
		austenitic, precipitation hardened (PH)	300	1010	M2	●	
K	Grey cast iron		245	–	K3, K4		
	Cast iron with spheroidal graphite GGV (CGI)	ferritic, pearlitic	365	–	K1, K2, K5, K6		
			200	–	K7		
N	Aluminium wrought alloys	cannot be hardened	30	–	N1		
		hardenable, hardened	100	340	N2		
	Cast aluminium alloys	≤ 12% Si	90	310	N3, N4		
		> 12% Si	130	450	N5		
	Magnesium alloys		70	250	N6		
	Copper and copper alloys (bronze/brass)	non-alloyed, electrolytic copper	100	340	N7		
		brass, bronze, red brass	90	310	N8		
Cu-alloys, short-chipping		110	380	N9			
high-strength, Ampco		300	1010	N10			
S	Heat-resistant alloys	Fe-based	280	940	S1, S2		
		Ni or Co base	250	840	S3		●
		Ni or Co base	350	1080	S4, S5		●
	Titanium alloys	pure titanium	200	670	S6		
		α and β alloys, hardened	375	1260	S7		●
		β alloys	410	1400	S8		●
	Tungsten alloys		300	1010	S9		
Molybdenum alloys		300	1010	S10			
H	Hardened steel		50 HRC	–	H1		
			55 HRC	–	H2, H4		
			60 HRC	–	H3		
O	Thermoplasts	without abrasive fillers			O1		
	Thermosetting plastics	without abrasive fillers			O2		
	Plastic, fibre-reinforced	GFRP, AFRP			O3, O5		
		CFRP			O4		
Graphite (technical)			65		O6		

* The pages indicated in italics refer to the Walter General catalogue 2012.

Walter Select – Tapping

Blind hole machining

HSS-E (-PM)

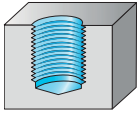









BH = Blind hole
TH = Through hole

Thread depth		3,0 x D _N	
Type		Paradur® Eco Cl	Paradur® X-pert N
		Page	Page
M		<i>D 106*</i>	D-53
MJ			
MF		<i>D 168*</i>	D-75
UNC	UNJC	<i>D 194*</i>	D-88
UNF	UNJF	<i>D 221*</i>	
UNEF	UN-8		
G		<i>D 245*</i>	D-111
RC	RP		
NPT	NPSM		
NPTF			
Pg	BSW		
TR			
EG M	EG MF		D-118
EG UNC			D-122
EG UNF			D-127
Coating		nid /TiCN	uncoated
Application		GL/DL	GL

Material group	Grouping of main material groups and code letters		Brinell hardness HB	Tensile strength R _m N/mm ²	Machining group			
	Workpiece material							
P	Non-alloyed and low-alloyed steel	annealed (tempered)	210	700	P1, P2, P3, P4, P7			
		free cutting steel	220	750	P6			
		tempered	300	1010	P5, P8			
		tempered	380	1280	P9			
		tempered	430	1480	P10			
	High-alloyed steel and high-alloyed tool steel	annealed	200	670	P11			
		hardened and tempered	300	1010	P12			
hardened and tempered		400	1360	P13				
Stainless steel	ferritic/martensitic, annealed	200	670	P14				
	martensitic, tempered	330	1110	P15				
M	Stainless steel	austenitic, duplex	230	780	M1, M3			
		austenitic, precipitation hardened (PH)	300	1010	M2			
K	Grey cast iron		245	-	K3, K4	●●		
	Cast iron with spheroidal graphite	ferritic, pearlitic	365	-	K1, K2, K5, K6	●		
	GGV (CGI)		200	-	K7	●●		
N	Aluminium wrought alloys	cannot be hardened	30	-	N1		●●	
		hardenable, hardened	100	340	N2		●●	
	Cast aluminium alloys	≤ 12% Si	90	310	N3, N4	●●	●●	
		> 12% Si	130	450	N5	●●		
	Magnesium alloys		70	250	N6	●●		
		Copper and copper alloys (bronze/brass)	non-alloyed, electrolytic copper	100	340	N7		●●
			brass, bronze, red brass	90	310	N8		
Cu-alloys, short-chipping	110		380	N9				
high-strength, Ampco	300		1010	N10				
S	Heat-resistant alloys	Fe-based	280	940	S1, S2			
		Ni or Co base	250	840	S3			
		Ni or Co base	350	1080	S4, S5			
	Titanium alloys	pure titanium	200	670	S6		●●	
		α and β alloys, hardened	375	1260	S7			
		β alloys	410	1400	S8			
	Tungsten alloys		300	1010	S9			
	Molybdenum alloys		300	1010	S10			
	H	Hardened steel		50 HRC	-	H1		
				55 HRC	-	H2, H4		
			60 HRC	-	H3			
O	Thermoplasts	without abrasive fillers			O1		●●	
	Thermosetting plastics	without abrasive fillers			O2	●		
	Plastic, fibre-reinforced	GFRP, AFRP			O3, O5	●●		
		CFRP			O4	●●		
Graphite (technical)			65		O6	●		

* The pages indicated in italics refer to the Walter General catalogue 2012.

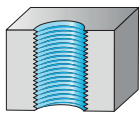

	3,0 x D _N			3,5 x D _N					
	Paradur® WLM Synchronspeed	KMB WST	KMB MS	Paradur® HT	Paradur® NH	Paradur® Short Chip soft	Paradur® WTH Inox 50	Paradur® MS	Paradur® Short Chip HT
	Page	Page	Page	Page	Page	Page	Page	Page	Page
	D 114*	D 63*	D 64*	D 81* / D-47	D 85*	D 97*	D 102*	D 115*	D-48
				D 155* / D-71		D 162*			D-72
			D 236*				D 244*		
	uncoated/CRN	uncoated	uncoated	uncoated/TiN	uncoated/TiN	vap/TiN	vap/TiN	uncoated	THL
	GL	GL	GL /DL	GL	GL	GL	GL	GL/DL	GL
									
	•	••			•	••			
	•	••		•	•	••	•		•
				••	••		••		••
				••	••				••
		••		•			•		
				••			••		••
				••			•		•
							••		
							•		
				•			••		•
				••	••	••			••
	••	•		•	•				
	••	•		•	•				•
	•	•		•	•				••
	•			•	•				
	••		••	•	•			•	•
	•			•	•			••	•
	••								
	••		•	•	•			•	•
				•				•	•
				•				•	•
				•				•	•

Walter Select – Tapping Through hole machining HSS-E (-PM)



BH = Blind hole
TH = Through hole

Thread depth	1,0 x D _N	1,5 x D _N	
Type	Prototex® 0S	Paradur® H	
	Page	Page	
M	<i>D 40*</i>		
MJ			
MF		<i>D 150*</i>	
UNC	UNJC		
UNF	UNJF		
UNEF	UN-8		
G		<i>D 238*</i>	
RC	RP	<i>D 249* / D 250*</i>	
NPT	NPSM	<i>D 251*</i>	
NPTF		<i>D 256*</i>	
Pg	BSW		
TR			
EG M	EG MF		
EG UNC			
EG UNF			
Coating	uncoated	uncoated/TiN	
Application	DL	GL/DL	

Material group	Grouping of main material groups and code letters		Brinell hardness HB	Tensile strength R _m N/mm ²	Machining group			
	Workpiece material							
P	Non-alloyed and low-alloyed steel	annealed (tempered)	210	700	P1, P2, P3, P4, P7	●●		
		free cutting steel	220	750	P6	●●		
		tempered	300	1010	P5, P8			
		tempered	380	1280	P9			
		tempered	430	1480	P10			
	High-alloyed steel and high-alloyed tool steel	annealed	200	670	P11			
hardened and tempered		300	1010	P12				
hardened and tempered		400	1360	P13				
Stainless steel	ferritic/martensitic, annealed	200	670	P14				
	martensitic, tempered	330	1110	P15				
M	Stainless steel	austenitic, duplex	230	780	M1, M3			
		austenitic, precipitation hardened (PH)	300	1010	M2			
K	Grey cast iron		245	–	K3, K4			
	Cast iron with spheroidal graphite GGV (CGI)	ferritic, pearlitic	365	–	K1, K2, K5, K6		●	
			200	–	K7			
N	Aluminium wrought alloys	cannot be hardened	30	–	N1	●		
		hardenable, hardened	100	340	N2	●	●	
	Cast aluminium alloys	≤ 12% Si	90	310	N3, N4		●	
		> 12% Si	130	450	N5		●	
	Magnesium alloys		70	250	N6		●	
		Copper and copper alloys (bronze/brass)	non-alloyed, electrolytic copper	100	340	N7		
brass, bronze, red brass			90	310	N8		●	
Cu-alloys, short-chipping	110		380	N9		●		
high-strength, Ampco	300		1010	N10				
S	Heat-resistant alloys	Fe-based	280	940	S1, S2			
		Ni or Co base	250	840	S3			
		Ni or Co base	350	1080	S4, S5			
	Titanium alloys	pure titanium	200	670	S6			
		α and β alloys, hardened	375	1260	S7			
		β alloys	410	1400	S8			
	Tungsten alloys		300	1010	S9			
Molybdenum alloys		300	1010	S10				
H	Hardened steel		50 HRC	–	H1			
			55 HRC	–	H2, H4			
			60 HRC	–	H3			
O	Thermoplasts	without abrasive fillers			O1			
	Thermosetting plastics	without abrasive fillers			O2		●	
	Plastic, fibre-reinforced	GFRP, AFRP			O3, O5		●	
		CFRP			O4		●	
Graphite (technical)			65		O6		●	

* The pages indicated in italics refer to the Walter General catalogue 2012.

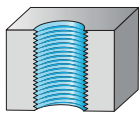

	1,5 x D _N		2,0 x D _N				
	Paradur Inox® 40	Paradur® Combi	Prototex® TiNi	Prototex® TiNi plus	TMB Trapezoidal	Paradur® FT	Paradur® AP
	Page	Page	Page	Page	Page	Page	Page
		D 59*	D 56*	D 58*		D 124*	D 116*
			D 144*	D 145*			
			D 185*				
			D 209*	D 211*			
	D 254*						
					D 262*		
			D 266*				
			D 278*				
			D 281*				
	uncoated	uncoated	uncoated/TiCN	ACN	uncoated	uncoated	nit
	GL/DL	DL	DL	DL	DL	GL/DL	GL/DL
	•	••			•		
	••	••			••		
	•		••				
			••				
	•	•			•		
	••		••		••		
	•						
	••						
	••		••				
	••				••		
		•			•		
		•			••		
		•	•		••		
	•		•		••		
		•					
		••			••		
		••					••
			••			•	
			••	••		•	
			••	••			
			••	••		•	
			•			•	
			•				
						•	
						•	
						•	

Walter Select – Tapping Through hole machining HSS-E (-PM)



BH = Blind hole
TH = Through hole

Thread depth		3,0 x D _N	
Type		Prototex® X-pert P	Prototex® X-pert N
		Page	Page
M		D-20	D-32
MJ			
MF		D-58	
UNC	UNJC	D-77	
UNF	UNJF	D-90	
UNEF	UN-8	D-94	
G		D-106	
RC	RP		
NPT	NPSM		
NPTF			
Pg	BSW	D-112	
TR			
EG M	EG MF	D-114	
EG UNC		D-120	
EG UNF		D-123	
Coating		uncoated/ TiN/TiCN	uncoated
Application		DL	DL

Material group	Grouping of main material groups and code letters		Birmell hardness HB	Tensile strength R _m N/mm ²	Machining group			
	Workpiece material							
P	Non-alloyed and low-alloyed steel	annealed (tempered)	210	700	P1, P2, P3, P4, P7	●		
		free cutting steel	220	750	P6	●●		
		tempered	300	1010	P5, P8	●		
		tempered	380	1280	P9			
		tempered	430	1480	P10			
	High-alloyed steel and high-alloyed tool steel	annealed	200	670	P11	●●		
		hardened and tempered	300	1010	P12	●		
		hardened and tempered	400	1360	P13			
	Stainless steel	ferritic/martensitic, annealed	200	670	P14			
		martensitic, tempered	330	1110	P15			
M	Stainless steel	austenitic, duplex	230	780	M1, M3			
		austenitic, precipitation hardened (PH)	300	1010	M2			
K	Grey cast iron		245	–	K3, K4			
	Cast iron with spheroidal graphite	ferritic, pearlitic	365	–	K1, K2, K5, K6			
	GGV (CGI)		200	–	K7			
N	Aluminium wrought alloys	cannot be hardened	30	–	N1	●	●●	
		hardenable, hardened	100	340	N2	●	●●	
	Cast aluminium alloys	≤ 12% Si	90	310	N3, N4	●●	●●	
		> 12% Si	130	450	N5	●		
	Magnesium alloys		70	250	N6	●		
	Copper and copper alloys (bronze/brass)	non-alloyed, electrolytic copper	100	340	N7		●●	
		brass, bronze, red brass	90	310	N8			
Cu-alloys, short-chipping		110	380	N9				
	high-strength, Ampco	300	1010	N10				
S	Heat-resistant alloys	Fe-based	280	940	S1, S2			
		Ni or Co base	250	840	S3			
		Ni or Co base	350	1080	S4, S5			
	Titanium alloys	pure titanium	200	670	S6		●●	
		α and β alloys, hardened	375	1260	S7			
		β alloys	410	1400	S8			
Tungsten alloys		300	1010	S9				
Molybdenum alloys		300	1010	S10				
H	Hardened steel		50 HRC	–	H1		●●	
			55 HRC	–	H2, H4			
			60 HRC	–	H3			
O	Thermoplasts	without abrasive fillers			O1	●		
	Thermosetting plastics	without abrasive fillers			O2			
	Plastic, fibre-reinforced	GFRP, AFRP				O3, O5		
		CFRP				O4		
Graphite (technical)			65		O6			

* The pages indicated in italics refer to the Walter General catalogue 2012.

	3,0 x D _N				3,5 x D _N	
	Prototex® X-pert M	Prototex® Synchrospeed	Paradur® X-pert K	Paradur® Eco CI	Prototex® Eco Plus	Paradur® MS
	Page	Page	Page	Page	Page	Page
	D-30	D 55*	D-52	D 106*	D-16	D 115*
	D-63	D 143*		D 168*	D-56	
	D-80			D 194*	D-76	
	D-93			D 221*	D-89	
	D-107	D 235*		D 245*	D-105	
	D-115					
	D-124					
	vap/TiN/TiCN	THL/TiN	TAFT	nid/TiN	TiN/THL	uncoated
	DL	DL	GL/DL	GL/DL	DL	GL/DL
	•	••			••	
	•	••			••	
	••	••			••	
	••	••			••	
					•	
	•	••			••	
	••	••			••	
		••			••	
	••	••			••	
	••	••			••	
	••	••			••	
	••	••			••	
	••	••			••	
	••	••			••	
	••	••			••	
	••	••			••	
			••	••	•	
		••	••	•	••	
		•	•	••	•	
		••		••	••	
		••	•	••	•	
		••		••	•	
		••			•	•
		••			•	••
		••				
		••				
		••				
		••				
				•		•
				••		•
				••		•
				•		

Machine tap Prototex® Eco Plus

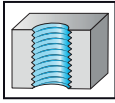

 $\leq 3,5 \times D_N$

- HSS-E-PM
- Chamfer form B = 3.5 - 5 thread
- Higher positioned core
- Materials from 500 to 1350 N/mm² or 42 HRC
- For long-chipping materials

M
DIN 13

	P	M	K	N	S	H	O
TiN	●	●	●	●			
THL	●	●	●	●			

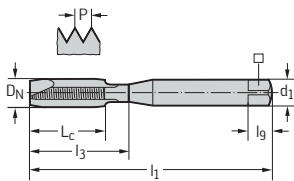
DIN 371 6HX



D _N	P mm	l ₁ js16 mm	L _c mm	l ₃ ±1 mm	d ₁ h9 mm	□ h12 mm	l _g mm	N	TiN Designation EP2021305	THL Designation EP2021302
M 2	0,4	45	6	9	2,8	2,1	5	3	★ -M2	★ -M2
M 2,5	0,45	50	8	12,5	2,8	2,1	5	3	★ -M2.5	★ -M2.5
M 3	0,5	56	9	18	3,5	2,7	6	3	★ -M3	★ -M3
M 4	0,7	63	12	21	4,5	3,4	6	3	★ -M4	★ -M4
M 5	0,8	70	13	25	6	4,9	8	3	★ -M5	★ -M5
M 6	1	80	15	30	6	4,9	8	3	★ -M6	★ -M6
M 8	1,25	90	18	35	8	6,2	9	3	★ -M8	★ -M8
M 10	1,5	100	20	39	10	8	11	3	★ -M10	★ -M10

DIN 376 6HX

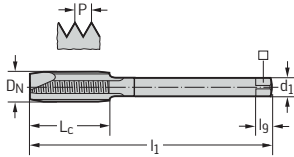

D _N	P mm	l ₁ js16 mm	L _c mm	l ₃ ±1 mm	d ₁ h9 mm	□ h12 mm	l _g mm	N	TiN Designation EP2026305	THL Designation EP2026302
M 12	1,75	110	23	-	9	7	10	4	★ -M12	★ -M12
M 14	2	110	25	-	11	9	12	4	★ -M14	★ -M14
M 16	2	110	25	-	12	9	12	4	★ -M16	★ -M16
M 18	2,5	125	30	-	14	11	14	4	★ -M18	★ -M18
M 20	2,5	140	30	-	16	12	15	4	★ -M20	★ -M20
M 24	3	160	36	-	18	14,5	17	4	★ -M24	★ -M24
M 27	3	160	36	-	20	16	19	4		★ -M27
M 30	3,5	180	42	-	22	18	21	4		★ -M30

★ New addition to range



Machine tap Prototex® Eco Plus



$\leq 3,5 \times D_N$

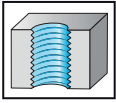

- HSS-E-PM
- Chamfer form B = 3.5 - 5 thread
- Higher positioned core
- Materials from 500 to 1350 N/mm² or 42 HRC
- For long-chipping materials

M

DIN 13

	P	M	K	N	S	H	O
TiN	●	●	●	●			
THL	●	●	●	●			

DIN 371 6GX		D_N	P mm	l_1 js16 mm	L_c mm	l_3 ± 1 mm	d_1 h9 mm	\square h12 mm	l_g mm	N	TiN Designation EP2023305	THL Designation EP2023302
	M 2	0,4	45	6	9	2,8	2,1	5	3	★ -M2	★ -M2	
	M 2,5	0,45	50	8	12,5	2,8	2,1	5	3	★ -M2.5	★ -M2.5	
	M 3	0,5	56	9	18	3,5	2,7	6	3	★ -M3	★ -M3	
	M 4	0,7	63	12	21	4,5	3,4	6	3	★ -M4	★ -M4	
	M 5	0,8	70	13	25	6	4,9	8	3	★ -M5	★ -M5	
	M 6	1	80	15	30	6	4,9	8	3	★ -M6	★ -M6	
	M 8	1,25	90	18	35	8	6,2	9	3	★ -M8	★ -M8	
	M 10	1,5	100	20	39	10	8	11	3	★ -M10	★ -M10	

DIN 376 6GX		D_N	P mm	l_1 js16 mm	L_c mm	l_3 ± 1 mm	d_1 h9 mm	\square h12 mm	l_g mm	N	TiN Designation EP2028305	THL Designation EP2028302
	M 12	1,75	110	23	-	9	7	10	4	★ -M12	★ -M12	
	M 14	2	110	25	-	11	9	12	4	★ -M14	★ -M14	
	M 16	2	110	25	-	12	9	12	4	★ -M16	★ -M16	

★ New addition to range



Machine tap Prototex® Eco Plus



$\leq 3,5 \times D_N$

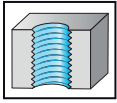

- HSS-E-PM
- Chamfer form B = 3.5 - 5 thread
- Higher positioned core
- Materials from 500 to 1350 N/mm² or 42 HRC
- For long-chipping materials
- Suitable for minimum quantity lubrication

M

DIN 13

	P	M	K	N	S	H	O
THL	●	●	●	●			

DIN 371 6HX		D_N	P mm	l_1 js16 mm	L_c mm	l_3 ± 1 mm	d_1 h9 mm	\square h12 mm	l_g mm	N	THL Designation EP2021342
		M 6	1	80	15	30	6	4,9	8	3	★ -M6
		M 8	1,25	90	18	35	8	6,2	9	3	★ -M8
		M 10	1,5	100	20	39	10	8	11	3	★ -M10

DIN 376 6HX		D_N	P mm	l_1 js16 mm	L_c mm	l_3 ± 1 mm	d_1 h9 mm	\square h12 mm	l_g mm	N	THL Designation EP2026342
		M 12	1,75	110	23	-	9	7	10	4	★ -M12
		M 16	2	110	25	-	12	9	12	4	★ -M16

★ New addition to range



Machine tap Prototex® Eco Plus



$\leq 3,5 \times D_N$

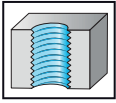

- HSS-E-PM
- Chamfer form B = 3.5 - 5 thread
- Left-hand thread
- Higher positioned core
- Long-chipping materials from 500 to 1350 N/mm² or 42 HRC

M

DIN 13

	P	M	K	N	S	H	O
THL	●●	●●	●●	●●			

DIN 371 6HX		D_N	P mm	l_1 js16 mm	L_c mm	l_3 ± 1 mm	d_1 h9 mm	\square h12 mm	l_g mm	N	THL Designation EP2021382
	M 3 LH		0,5	56	9	18	3,5	2,7	6	3	★ -M3
	M 4 LH		0,7	63	12	21	4,5	3,4	6	3	★ -M4
	M 5 LH		0,8	70	13	25	6	4,9	8	3	★ -M5
	M 6 LH		1	80	15	30	6	4,9	8	3	★ -M6
	M 8 LH		1,25	90	18	35	8	6,2	9	3	★ -M8
	M 10 LH		1,5	100	20	39	10	8	11	3	★ -M10

DIN 376 6HX		D_N	P mm	l_1 js16 mm	L_c mm	l_3 ± 1 mm	d_1 h9 mm	\square h12 mm	l_g mm	N	THL Designation EP2026382
	M 12 LH		1,75	110	23	-	9	7	10	4	★ -M12
	M 16 LH		2	110	25	-	12	9	12	4	★ -M16
	M 20 LH		2,5	140	30	-	16	12	15	4	★ -M20

★ New addition to range

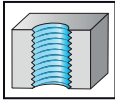

Machine tap Prototex® X-pert P

 $\leq 3 \times D_N$

- HSS-E
- Chamfer form B = 3.5 - 5 thread
- Materials from 200 to 1000 N/mm² or 32 HRC
- For long-chipping materials

M
DIN 13

	P	M	K	N	S	H	O
uncoated	●●	●	●	●	●	●	●
TiN	●●	●	●	●	●	●	●

DIN 371 ISO2/6H		D_N	P mm	l_1 js16 mm	L_c mm	l_3 ± 1 mm	d_1 h9 mm	\square h12 mm	l_g mm	N	uncoated Designation P20210	TiN Designation P2021005
	M 1	0,25	40	5	-	2,5	2,1	5	2	★ -M1 ¹		
	M 1,2	0,25	40	5	-	2,5	2,1	5	2	★ -M1.2 ¹	★ -M1.2 ¹	
	M 1,4	0,3	40	6,5	-	2,5	2,1	5	2	★ -M1.4 ¹	★ -M1.4 ¹	
	M 1,6	0,35	40	7	-	2,5	2,1	5	2	★ -M1.6 ¹	★ -M1.6 ¹	
	M 1,8	0,35	40	7	-	2,5	2,1	5	2	★ -M1.8 ¹		
	M 2	0,4	45	6	9	2,8	2,1	5	2	★ -M2	★ -M2	
	M 2,3	0,4	45	7	12	2,8	2,1	5	2	★ -M2.3		
	M 2,2	0,45	45	7	12	2,8	2,1	5	2	★ -M2.2		
	M 2,5	0,45	50	8	12,5	2,8	2,1	5	2	★ -M2.5	★ -M2.5	
	M 2,6	0,45	50	8	12,5	2,8	2,1	5	2	★ -M2.6		
	M 3	0,5	56	9	18	3,5	2,7	6	2	★ -M3	★ -M3	
	M 3,5	0,6	56	11	20	4	3	6	2	★ -M3.5	★ -M3.5	
	M 4	0,7	63	12	21	4,5	3,4	6	2	★ -M4	★ -M4	
	M 4,5	0,75	70	13	25	6	4,9	8	2	★ -M4.5		
M 5	0,8	70	13	25	6	4,9	8	2	★ -M5	★ -M5		
M 6	1	80	15	30	6	4,9	8	2	★ -M6	★ -M6		

 $\leq M 1.4: 5H, \geq M 1.6: ISO 2/6H$
¹ without reduced neck after the thread

★ New addition to range



Machine tap Prototex® X-pert P



$\leq 3 \times D_N$

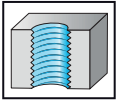

- HSS-E
- Chamfer form B = 3.5 - 5 thread
- Materials from 200 to 1000 N/mm² or 32 HRC
- For long-chipping materials

M

DIN 13

	P	M	K	N	S	H	O
uncoated	●●			●			●
TiN	●●			●			●

DIN 371		ISO3/6G									uncoated Designation P20230	TiN Designation P2023005
D_N	P mm	l_1 js16 mm	L_c mm	l_3 ± 1 mm	d_1 h9 mm	\square h12 mm	l_g mm	N				
M 2	0,4	45	6	9	2,8	2,1	5	2		★ -M2	★ -M2	
M 2,3	0,4	45	7	12	2,8	2,1	5	2		★ -M2.3		
M 2,5	0,45	50	8	12,5	2,8	2,1	5	2		★ -M2.5	★ -M2.5	
M 2,6	0,45	50	8	12,5	2,8	2,1	5	2		★ -M2.6		
M 3	0,5	56	9	18	3,5	2,7	6	2		★ -M3	★ -M3	
M 3,5	0,6	56	11	20	4	3	6	2		★ -M3.5	★ -M3.5	
M 4	0,7	63	12	21	4,5	3,4	6	2		★ -M4	★ -M4	
M 5	0,8	70	13	25	6	4,9	8	2		★ -M5	★ -M5	

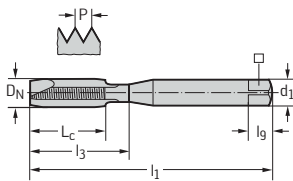

★ New addition to range



Machine tap Prototex® X-pert P



$\leq 3 \times D_N$

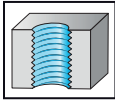

- HSS-E
- Chamfer form B = 3.5 - 5 thread
- Materials from 200 to 1000 N/mm² or 32 HRC
- For long-chipping materials

M

DIN 13

	P	M	K	N	S	H	O
uncoated	●	●	●	●	●	●	●

DIN 371	ISO1/4H	D_N	P mm	l_1 js16 mm	L_c mm	l_3 ± 1 mm	d_1 h9 mm	\square h12 mm	l_9 mm	N	uncoated Designation P20200
		M 1,6	0,35	40	7	-	2,5	2,1	5	2	★ -M1.6
		M 2	0,4	45	6	9	2,8	2,1	5	2	★ -M2
		M 2,2	0,45	45	7	12	2,8	2,1	5	2	★ -M2.2
		M 2,5	0,45	50	8	12,5	2,8	2,1	5	2	★ -M2.5
		M 3	0,5	56	9	18	3,5	2,7	6	2	★ -M3
		M 3,5	0,6	56	11	20	4	3	6	2	★ -M3.5
		M 4	0,7	63	12	21	4,5	3,4	6	2	★ -M4
		M 5	0,8	70	13	25	6	4,9	8	2	★ -M5
		M 6	1	80	15	30	6	4,9	8	2	★ -M6
		M 8	1,25	90	18	35	8	6,2	9	3	★ -M8
		M 10	1,5	100	20	39	10	8	11	3	★ -M10

¹ without reduced neck after the thread

Machine tap Prototex® X-pert P



$$\leq 3 \times D_N$$

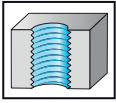

- HSS-E
- Chamfer form B = 3.5 - 5 thread
- Left-hand thread
- Materials from 200 to 1000 N/mm² or 32 HRC
- For long-chipping materials

M

DIN 13

	P	M	K	N	S	H	O
uncoated	●●			●			●

DIN 371	ISO2/6H	D_N	P mm	l_1 js16 mm	L_c mm	l_3 ± 1 mm	d_1 h9 mm	\square h12 mm	l_g mm	N	uncoated Designation P202108
		M 2 LH	0,4	45	6	9	2,8	2,1	5	2	★ -M2
		M 3 LH	0,5	56	9	18	3,5	2,7	6	2	★ -M3
		M 4 LH	0,7	63	12	21	4,5	3,4	6	2	★ -M4
		M 5 LH	0,8	70	13	25	6	4,9	8	2	★ -M5
		M 6 LH	1	80	15	30	6	4,9	8	3	★ -M6
		M 8 LH	1,25	90	18	35	8	6,2	9	3	★ -M8
		M 10 LH	1,5	100	20	39	10	8	11	3	★ -M10

DIN 376	ISO2/6H	D_N	P mm	l_1 js16 mm	L_c mm	l_3 ± 1 mm	d_1 h9 mm	\square h12 mm	l_g mm	N	uncoated Designation P202608
		M 12 LH	1,75	110	23	-	9	7	10	3	★ -M12
		M 16 LH	2	110	25	-	12	9	12	3	★ -M16
		M 20 LH	2,5	140	30	-	16	12	15	3	★ -M20

★ New addition to range



Machine tap
Prototex® X-pert P



$\leq 3 \times D_N$

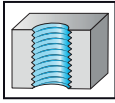

- HSS-E
- Chamfer form B = 3.5 - 5 thread
- Materials from 200 to 1000 N/mm² or 32 HRC
- For long-chipping materials

M
DIN 13

	P	M	K	N	S	H	O
uncoated	●●			●			●
TiN	●●			●			●
TiCN	●●			●			●

DIN 371 ISO2/6H		P	l ₁ js16	L _c	l ₃ ±1	d ₁ h9	□ h12	l _g	N	uncoated Designation P20310	TiN Designation P2031005	TiCN Designation P2031006
D _N	P	mm	mm	mm	mm	mm	mm	mm				
M 2	0,4	45	6	9	2,8	2,1	5	3	★ -M2	★ -M2	★ -M2	
M 2,2	0,45	45	7	12	2,8	2,1	5	3	★ -M2.2	★ -M2.2	★ -M2.2	
M 2,5	0,45	50	8	12,5	2,8	2,1	5	3	★ -M2.5	★ -M2.5	★ -M2.5	
M 3	0,5	56	9	18	3,5	2,7	6	3	★ -M3	★ -M3	★ -M3	
M 3,5	0,6	56	11	20	4	3	6	3	★ -M3.5			
M 4	0,7	63	12	21	4,5	3,4	6	3	★ -M4	★ -M4	★ -M4	
M 5	0,8	70	13	25	6	4,9	8	3	★ -M5	★ -M5	★ -M5	
M 6	1	80	15	30	6	4,9	8	3	★ -M6	★ -M6	★ -M6	
M 7	1	80	15	30	7	5,5	8	3	★ -M7	★ -M7		
M 8	1,25	90	18	35	8	6,2	9	3	★ -M8	★ -M8	★ -M8	
M 10	1,5	100	20	39	10	8	11	3	★ -M10	★ -M10	★ -M10	

DIN 376 ISO2/6H		P	l ₁ js16	L _c	l ₃ ±1	d ₁ h9	□ h12	l _g	N	uncoated Designation P20360	TiN Designation P2036005	TiCN Designation P2036006
D _N	P	mm	mm	mm	mm	mm	mm	mm				
M 2	0,4	45	6	-	1,4	1,12	4	3	★ -M2			
M 2,5	0,45	50	8	-	1,8	1,4	4	3	★ -M2.5			
M 3	0,5	56	9	-	2,2	1,8	4	3	★ -M3			
M 4	0,7	63	12	-	2,8	2,1	5	3	★ -M4			
M 5	0,8	70	13	-	3,5	2,7	6	3	★ -M5			
M 6	1	80	15	-	4,5	3,4	6	3	★ -M6	★ -M6	★ -M6	
M 7	1	80	15	-	5,5	4,3	7	3	★ -M7			
M 8	1,25	90	18	-	6	4,9	8	3	★ -M8	★ -M8	★ -M8	
M 9	1,25	90	18	-	7	5,5	8	3	★ -M9			
M 10	1,5	100	20	-	7	5,5	8	3	★ -M10	★ -M10	★ -M10	
M 12	1,75	110	23	-	9	7	10	3	★ -M12	★ -M12	★ -M12	
M 14	2	110	25	-	11	9	12	3	★ -M14	★ -M14		
M 16	2	110	25	-	12	9	12	3	★ -M16	★ -M16	★ -M16	
M 18	2,5	125	30	-	14	11	14	4	★ -M18	★ -M18		
M 20	2,5	140	30	-	16	12	15	4	★ -M20	★ -M20	★ -M20	
M 22	2,5	140	30	-	18	14,5	17	4	★ -M22			
M 24	3	160	36	-	18	14,5	17	4	★ -M24	★ -M24	★ -M24	
M 27	3	160	36	-	20	16	19	4	★ -M27	★ -M27		
M 30	3,5	180	42	-	22	18	21	4	★ -M30	★ -M30	★ -M30	
M 33	3,5	180	42	-	25	20	23	4	★ -M33			
M 36	4	200	48	-	28	22	25	4	★ -M36	★ -M36		
M 39	4	200	48	-	32	24	27	4	★ -M39			
M 42	4,5	200	54	-	32	24	27	4	★ -M42			
M 45	4,5	220	54	-	36	29	32	4	★ -M45			
M 48	5	250	60	-	36	29	32	4	★ -M48			
M 52	5	250	60	-	40	32	35	4	★ -M52			
M 56	5,5	250	66	-	40	32	35	4	★ -M56			

★ New addition to range



Machine tap Prototex® X-pert P



$\leq 3 \times D_N$

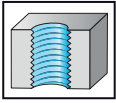

- HSS-E
- Chamfer form B = 3.5 - 5 thread
- Materials from 200 to 1000 N/mm² or 32 HRC
- For long-chipping materials

M

DIN 13

	P	M	K	N	S	H	O
uncoated	●●			●			●
TiN	●●			●			●

DIN 371 ISO3/6G		D_N	P mm	l_1 js16 mm	L_c mm	l_3 ± 1 mm	d_1 h9 mm	\square h12 mm	l_g mm	N	uncoated Designation P20330	TiN Designation P2033005
	M 2,5	0,45	50	8	12,5	2,8	2,1	5	3	★ -M2.5		
	M 3	0,5	56	9	18	3,5	2,7	6	3	★ -M3		
	M 3,5	0,6	56	11	20	4	3	6	3	★ -M3.5		
	M 4	0,7	63	12	21	4,5	3,4	6	3	★ -M4		
	M 5	0,8	70	13	25	6	4,9	8	3	★ -M5		
	M 6	1	80	15	30	6	4,9	8	3	★ -M6	★ -M6	
	M 7	1	80	15	30	7	5,5	8	3	★ -M7		
	M 8	1,25	90	18	35	8	6,2	9	3	★ -M8	★ -M8	
	M 10	1,5	100	20	39	10	8	11	3	★ -M10	★ -M10	

DIN 376 ISO3/6G		D_N	P mm	l_1 js16 mm	L_c mm	l_3 ± 1 mm	d_1 h9 mm	\square h12 mm	l_g mm	N	uncoated Designation P20380
	M 5	0,8	70	13	-	3,5	2,7	6	3	★ -M5	
	M 6	1	80	15	-	4,5	3,4	6	3	★ -M6	
	M 8	1,25	90	18	-	6	4,9	8	3	★ -M8	
	M 10	1,5	100	20	-	7	5,5	8	3	★ -M10	
	M 12	1,75	110	23	-	9	7	10	3	★ -M12	
	M 14	2	110	25	-	11	9	12	3	★ -M14	
	M 16	2	110	25	-	12	9	12	3	★ -M16	
	M 18	2,5	125	30	-	14	11	14	4	★ -M18	
	M 20	2,5	140	30	-	16	12	15	4	★ -M20	
	M 24	3	160	36	-	18	14,5	17	4	★ -M24	

★ New addition to range



Machine tap Prototex® X-pert P

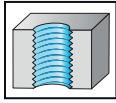

 $\leq 3 \times D_N$

- HSS-E
- Chamfer form B = 3.5 - 5 thread
- Materials from 200 to 1000 N/mm² or 32 HRC
- For long-chipping materials

M
DIN 13

	P	M	K	N	S	H	O
uncoated	●●			●			●
TiN	●●			●			●

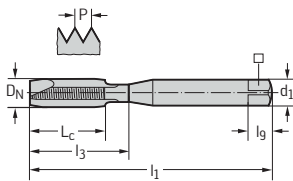
DIN 371 7G



D _N	P mm	l ₁ js16 mm	L _c mm	l ₃ ±1 mm	d ₁ h9 mm	□ h12 mm	l _g mm	N	uncoated Designation P20340	TiN Designation P2034005
M 2	0,4	45	6	11	2,8	2,1	5	3	★ -M2	★ -M2
M 2,5	0,45	50	8	12,5	2,8	2,1	5	3	★ -M2.5	★ -M2.5
M 2,6	0,45	50	8	14	2,8	2,1	5	3	★ -M2.6	
M 3	0,5	56	9	18	3,5	2,7	6	3	★ -M3	★ -M3
M 3,5	0,6	56	11	20	4	3	6	3	★ -M3.5	★ -M3.5
M 4	0,7	63	12	21	4,5	3,4	6	3	★ -M4	★ -M4
M 5	0,8	70	13	25	6	4,9	8	3	★ -M5	★ -M5
M 6	1	80	15	30	6	4,9	8	3	★ -M6	★ -M6
M 8	1,25	90	18	35	8	6,2	9	3	★ -M8	★ -M8
M 10	1,5	100	20	39	10	8	11	3	★ -M10	★ -M10

DIN 376 7G

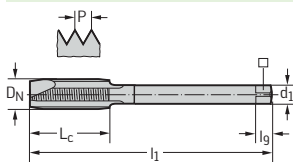

D _N	P mm	l ₁ js16 mm	L _c mm	l ₃ ±1 mm	d ₁ h9 mm	□ h12 mm	l _g mm	N	uncoated Designation P20390	TiN Designation P2039005
M 12	1,75	110	23	-	9	7	10	3	★ -M12	★ -M12
M 16	2	110	25	-	12	9	12	3	★ -M16	★ -M16
M 20	2,5	140	30	-	16	12	15	4	★ -M20	★ -M20

★ New addition to range



Machine tap Prototex® X-pert P



$\leq 3 \times D_N$

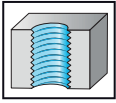

- HSS-E
- Overall length L = long
- Chamfer form B = 3.5 - 5 thread
- Materials from 200 to 1000 N/mm² or 32 HRC
- For long-chipping materials

M

DIN 13

	P	M	K	N	S	H	O
uncoated	●●			●			●
TiN	●●			●			●

~DIN 371 ISO2/6H		D_N	P mm	l_1 js16 mm	L_c mm	l_3 ± 1 mm	d_1 h9 mm	\square h12 mm	l_g mm	N	uncoated Designation P203103	TiN Designation P2031035
	M 3	0.5	112	9	18	3.5	2.7	6	3	★ -M3	★ -M3	
	M 4	0.7	112	12	21	4.5	3.4	6	3	★ -M4	★ -M4	
	M 5	0.8	125	13	25	6	4.9	8	3	★ -M5	★ -M5	
	M 6	1	125	15	30	6	4.9	8	3	★ -M6	★ -M6	
	M 8	1.25	140	18	40	8	6.2	9	3	★ -M8	★ -M8	
	M 10	1.5	160	20	50	10	8	11	3	★ -M10	★ -M10	

~DIN 376 ISO2/6H		D_N	P mm	l_1 js16 mm	L_c mm	l_3 ± 1 mm	d_1 h9 mm	\square h12 mm	l_g mm	N	uncoated Designation P203603	TiN Designation P2036035
	M 3	0.5	112	9	-	2.2	1.8	4	3	★ -M3		
	M 4	0.7	112	12	-	2.8	2.1	5	3	★ -M4		
	M 5	0.8	125	13	-	3.5	2.7	6	3	★ -M5	★ -M5	
	M 6	1	125	15	-	4.5	3.4	6	3	★ -M6	★ -M6	
	M 8	1.25	140	18	-	6	4.9	8	3	★ -M8	★ -M8	
	M 10	1.5	160	20	-	7	5.5	8	3	★ -M10	★ -M10	
	M 12	1.75	180	23	-	9	7	10	3	★ -M12	★ -M12	
	M 14	2	180	25	-	11	9	12	3	★ -M14	★ -M14	
	M 16	2	200	25	-	12	9	12	3	★ -M16	★ -M16	
	M 20	2.5	224	30	-	16	12	15	4	★ -M20	★ -M20	

★ New addition to range



Machine tap Prototex® X-pert P



$\leq 3 \times D_N$

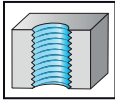

- HSS-E
- Overall length XL = extra long
- Chamfer form B = 3.5 - 5 thread
- Materials from 200 to 1000 N/mm² or 32 HRC
- For long-chipping materials

M

DIN 13

	P	M	K	N	S	H	O
uncoated	●●			●			●

~DIN 371 ISO2/6H		D_N	P mm	l_1 js16 mm	L_c mm	l_3 ± 1 mm	d_1 h9 mm	\square h12 mm	l_g mm	N	uncoated Designation P202103
		M 4	0,7	125	12	21	4,5	3,4	6	3	★ -M4
		M 5	0,8	140	13	25	6	4,9	8	3	★ -M5
		M 6	1	160	15	30	6	4,9	8	3	★ -M6

~DIN 376 ISO2/6H		D_N	P mm	l_1 js16 mm	L_c mm	l_3 ± 1 mm	d_1 h9 mm	\square h12 mm	l_g mm	N	uncoated Designation P202603
		M 8	1,25	180	18	-	6	4,9	8	3	★ -M8
		M 10	1,5	200	20	-	7	5,5	8	3	★ -M10
		M 12	1,75	220	23	-	9	7	10	3	★ -M12
		M 14	2	220	25	-	11	9	12	3	★ -M14
		M 16	2	220	25	-	12	9	12	3	★ -M16
		M 20	2,5	280	30	-	16	12	15	4	★ -M20

★ New addition to range



Machine tap Prototex® X-pert P AZ



$\leq 3 \times D_N$

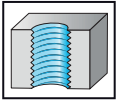

- HSS-E
- Chamfer form B = 3.5 - 5 thread
- Materials from 200 to 1000 N/mm² or 32 HRC
- For long-chipping materials
- For thin-walled workpieces
- Interrupted teeth

M

DIN 13

	P	M	K	N	S	H	O
uncoated	●●	●	●●	●●	●	●	●

DIN 371 ISO2/6H		P	l_1 js16	L_c	l_3 ± 1	d_1 h9	\square h12	l_g	N	uncoated Designation P40310
D_N	P	mm	mm	mm	mm	mm	mm	mm		
M 3	0,5	56	9	18	3,5	2,7	6	3	★	-M3
M 4	0,7	63	12	21	4,5	3,4	6	3	★	-M4
M 5	0,8	70	13	25	6	4,9	8	3	★	-M5
M 6	1	80	15	30	6	4,9	8	3	★	-M6
M 8	1,25	90	18	35	8	6,2	9	3	★	-M8
M 10	1,5	100	20	39	10	8	11	3	★	-M10

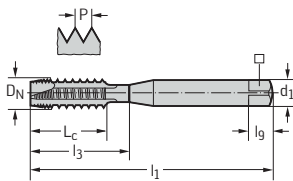

DIN 376 ISO2/6H		P	l_1 js16	L_c	l_3 ± 1	d_1 h9	\square h12	l_g	N	uncoated Designation P40360
D_N	P	mm	mm	mm	mm	mm	mm	mm		
M 12	1,75	110	23	-	9	7	10	3	★	-M12
M 14	2	110	25	-	11	9	12	3	★	-M14
M 16	2	110	25	-	12	9	12	3	★	-M16
M 20	2,5	140	30	-	16	12	15	4	★	-M20
M 24	3	160	36	-	18	14,5	17	4	★	-M24

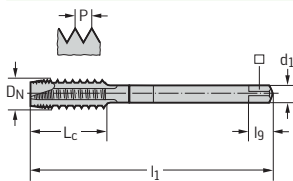

★ New addition to range



Machine tap Prototex® X-pert M



$\leq 3 \times D_N$

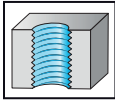

- HSS-E
- Chamfer form B = 3.5 - 5 thread
- Higher positioned core
- Materials from 350 to 1200 N/mm² or 36 HRC
- For long-chipping materials

M
DIN 13

	P	M	K	N	S	H	O
vap	●	●●	■	■	■	■	■
TiN	●	●●	■	■	■	■	■
TiCN	●	●●	■	■	■	■	■

DIN 371 6HX		D_N	P mm	l_1 js16 mm	L_c mm	l_3 ± 1 mm	d_1 h9 mm	\square h12 mm	l_g mm	N	VAP Designation M20213	TiN Designation M2021305	TiCN Designation M2021306
		M 1	0,25	40	5	-	2,5	2,1	5	2	★ -M1 ¹		
		M 1,2	0,25	40	5	-	2,5	2,1	5	2	★ -M1,2 ¹		
		M 1,4	0,3	40	6,5	-	2,5	2,1	5	2	★ -M1,4 ¹		
		M 1,6	0,35	40	7	-	2,5	2,1	5	2	★ -M1,6 ¹		
		M 1,7	0,35	40	7	-	2,5	2,1	5	2	★ -M1,7 ¹		
		M 1,8	0,35	40	7	-	2,5	2,1	5	2	★ -M1,8 ¹		
		M 2	0,4	45	6	9	2,8	2,1	5	2	★ -M2	★ -M2	★ -M2
		M 2,3	0,4	45	7	12	2,8	2,1	5	2	★ -M2,3		
		M 2,2	0,45	45	7	12	2,8	2,1	5	2	★ -M2,2		
		M 2,5	0,45	50	8	12,5	2,8	2,1	5	2	★ -M2,5	★ -M2,5	★ -M2,5
		M 2,6	0,45	50	8	12,5	2,8	2,1	5	2	★ -M2,6		
		M 3	0,5	56	9	18	3,5	2,7	6	2	★ -M3	★ -M3	★ -M3
		M 3,5	0,6	56	11	20	4	3	6	2	★ -M3,5	★ -M3,5	★ -M3,5
		M 4	0,7	63	12	21	4,5	3,4	6	3	★ -M4	★ -M4	★ -M4
		M 4,5	0,75	70	13	25	6	4,9	8	3	★ -M4,5		
		M 5	0,8	70	13	25	6	4,9	8	3	★ -M5	★ -M5	★ -M5
		M 6	1	80	15	30	6	4,9	8	3	★ -M6	★ -M6	★ -M6
		M 7	1	80	15	30	7	5,5	8	3	★ -M7		
		M 8	1,25	90	18	35	8	6,2	9	3	★ -M8	★ -M8	★ -M8
		M 9	1,25	90	18	35	9	7	10	3	★ -M9		
		M 10	1,5	100	20	39	10	8	11	3	★ -M10	★ -M10	★ -M10

$\leq M 1,4: 5HX$

¹ without reduced neck after the thread

DIN 376 6HX		D_N	P mm	l_1 js16 mm	L_c mm	l_3 ± 1 mm	d_1 h9 mm	\square h12 mm	l_g mm	N	VAP Designation M20263	TiN Designation M2026305	TiCN Designation M2026306
		M 5	0,8	70	13	-	3,5	2,7	6	3	★ -M5		★ -M5
		M 6	1	80	15	-	4,5	3,4	6	3	★ -M6		★ -M6
		M 8	1,25	90	18	-	6	4,9	8	3	★ -M8		★ -M8
		M 10	1,5	100	20	-	7	5,5	8	3	★ -M10		★ -M10
		M 12	1,75	110	23	-	9	7	10	4	★ -M12	★ -M12	★ -M12
		M 14	2	110	25	-	11	9	12	4	★ -M14	★ -M14	★ -M14
		M 16	2	110	25	-	12	9	12	4	★ -M16	★ -M16	★ -M16
		M 18	2,5	125	30	-	14	11	14	4	★ -M18		
		M 20	2,5	140	30	-	16	12	15	4	★ -M20	★ -M20	★ -M20
		M 22	2,5	140	30	-	18	14,5	17	4	★ -M22		
		M 24	3	160	36	-	18	14,5	17	4	★ -M24		★ -M24
		M 27	3	160	36	-	20	16	19	4	★ -M27		
		M 30	3,5	180	42	-	22	18	21	4	★ -M30		
		M 33	3,5	180	42	-	25	20	23	5	★ -M33		
		M 36	4	200	48	-	28	22	25	5	★ -M36		

★ New addition to range



Machine tap Prototex® X-pert M



$\leq 3 \times D_N$

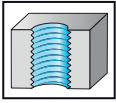

- HSS-E
- Chamfer form B = 3.5 - 5 thread
- Higher positioned core
- Materials from 350 to 1200 N/mm² or 36 HRC
- For long-chipping materials

M

DIN 13

	P	M	K	N	S	H	O
vap	●	●●	●	●	●	●	●
TiCN	●	●●	●	●	●	●	●

DIN 371 6GX		D_N	P mm	l_1 js16 mm	L_c mm	l_3 ± 1 mm	d_1 h9 mm	\square h12 mm	l_g mm	N	VAP Designation M20233	TiCN Designation M2023306
		M 3	0,5	56	9	18	3,5	2,7	6	2	★ -M3	★ -M3
		M 4	0,7	63	12	21	4,5	3,4	6	3	★ -M4	★ -M4
		M 5	0,8	70	13	25	6	4,9	8	3	★ -M5	★ -M5
		M 6	1	80	15	30	6	4,9	8	3	★ -M6	★ -M6
		M 7	1	80	15	30	7	5,5	8	3	★ -M7	★ -M7
		M 8	1,25	90	18	35	8	6,2	9	3	★ -M8	★ -M8
		M 10	1,5	100	20	39	10	8	11	3	★ -M10	★ -M10

★ New addition to range



Machine tap Prototex® X-pert N



$\leq 3 \times D_N$

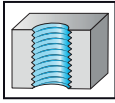

- HSS-E
- Chamfer form B = 3.5 - 5 thread
- Materials from 200 to 700 N/mm² or 14 HRC
- For long-chipping materials

M

DIN 13

	P	M	K	N	S	H	O
uncoated	●	●	●	●●	●	●	●

DIN 371	ISO2/6H	D_N	P mm	l_1 js16 mm	L_c mm	l_3 ± 1 mm	d_1 h9 mm	\square h12 mm	l_g mm	N	uncoated Designation N20219
		M 2	0,4	45	6	9	2,8	2,1	5	2	★ -M2
		M 2,5	0,45	50	8	12,5	2,8	2,1	5	2	★ -M2.5
		M 3	0,5	56	9	18	3,5	2,7	6	2	★ -M3
		M 4	0,7	63	12	21	4,5	3,4	6	2	★ -M4
		M 5	0,8	70	13	25	6	4,9	8	2	★ -M5
		M 6	1	80	15	30	6	4,9	8	3	★ -M6
		M 8	1,25	90	18	35	8	6,2	9	3	★ -M8
		M 10	1,5	100	20	39	10	8	11	3	★ -M10

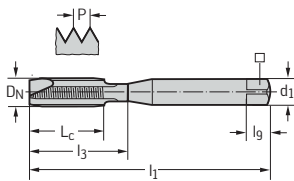

★ New addition to range



Machine tap Paradur® Eco Plus



$\leq 3 \times D_N$

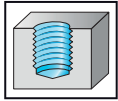

- HSS-E-PM
- Chamfer form C = 2 - 3 thread
- 45° helix angle
- Long-chipping materials from 500 to 1250 N/mm² or 38 HRC

M

DIN 13

	P	M	K	N	S	H	O
TiN	●	●	●	●			
THL	●	●	●	●			

~DIN 371 6HX		D_N	P mm	l_1 js16 mm	L_c mm	l_3 ± 1 mm	d_1 h9 mm	\square h12 mm	l_g mm	N	TiN Designation EP2051305	THL Designation EP2051302
		M 2	0,4	45	4	7,6	2,8	2,1	5	3	★ -M2 ⁴	★ -M2 ⁴
		M 2,5	0,45	50	4	9,3	2,8	2,1	5	3	★ -M2.5 ⁴	★ -M2.5 ⁴
		M 3	0,5	56	6	11	3,5	2,7	6	3	★ -M3	★ -M3
		M 4	0,7	63	7	14,8	4,5	3,4	6	3	★ -M4	★ -M4
		M 5	0,8	70	8	20,7	6	4,9	8	3	★ -M5	★ -M5
		M 6	1	80	10	25	6	4,9	8	3	★ -M6	★ -M6
		M 8	1,25	90	12	35	8	6,2	9	3	★ -M8	★ -M8
		M 10	1,5	100	15	39	10	8	11	3	★ -M10	★ -M10

⁴ without thread taper

DIN 376 6HX		D_N	P mm	l_1 js16 mm	L_c mm	l_3 ± 1 mm	d_1 h9 mm	\square h12 mm	l_g mm	N	TiN Designation EP2056305	THL Designation EP2056302
		M 12	1,75	110	16	-	9	7	10	4	★ -M12	★ -M12
		M 14	2	110	20	-	11	9	12	4	★ -M14	★ -M14
		M 16	2	110	20	-	12	9	12	4	★ -M16	★ -M16
		M 18	2,5	125	25	-	14	11	14	4	★ -M18	★ -M18
		M 20	2,5	140	25	-	16	12	15	4	★ -M20	★ -M20
		M 24	3	160	30	-	18	14,5	17	4	★ -M24	★ -M24
		M 27	3	160	30	-	20	16	19	4		★ -M27
		M 30	3,5	180	35	-	22	18	21	4		★ -M30
		M 36	4	200	40	-	28	22	25	4		★ -M36
		M 42	4,5	200	45	-	32	24	27	5		★ -M42
		M 48	5	250	50	-	36	29	32	5		★ -M48
		M 56	5,5	250	55	-	40	32	35	5		★ -M56
		M 64	6	315	60	-	50	39	42	6		★ -M64

★ New addition to range



Machine tap Paradur® Eco Plus



$\leq 3 \times D_N$

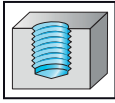

- HSS-E-PM
- Chamfer form C = 2 - 3 thread
- 45° helix angle
- Long-chipping materials from 500 to 1250 N/mm² or 38 HRC

M
DIN 13

	P	M	K	N	S	H	O
TiN	●	●	●	●			
THL	●	●	●	●			

~DIN 371 6GX		D_N	P mm	l_1 js16 mm	L_c mm	l_3 ± 1 mm	d_1 h9 mm	\square h12 mm	l_g mm	N	TiN Designation EP2053305	THL Designation EP2053302
		M 2	0,4	45	4	7,6	2,8	2,1	5	3	★ -M2 ⁴	★ -M2 ⁴
		M 2,5	0,45	50	4	9,3	2,8	2,1	5	3	★ -M2.5 ⁴	★ -M2.5 ⁴
		M 3	0,5	56	6	11	3,5	2,7	6	3	★ -M3	★ -M3
		M 4	0,7	63	7	14,8	4,5	3,4	6	3	★ -M4	★ -M4
		M 5	0,8	70	8	20,7	6	4,9	8	3	★ -M5	★ -M5
		M 6	1	80	10	25	6	4,9	8	3	★ -M6	★ -M6
		M 8	1,25	90	12	35	8	6,2	9	3	★ -M8	★ -M8
		M 10	1,5	100	15	39	10	8	11	3	★ -M10	★ -M10

⁴ without thread taper

DIN 376 6GX		D_N	P mm	l_1 js16 mm	L_c mm	l_3 ± 1 mm	d_1 h9 mm	\square h12 mm	l_g mm	N	TiN Designation EP2058305	THL Designation EP2058302
		M 12	1,75	110	16	-	9	7	10	4	★ -M12	★ -M12
		M 14	2	110	20	-	11	9	12	4	★ -M14	★ -M14
		M 16	2	110	20	-	12	9	12	4	★ -M16	★ -M16

★ New addition to range



Machine tap Paradur® Eco Plus



$\leq 3 \times D_N$

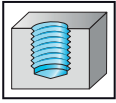

- HSS-E-PM
- Chamfer form C = 2 - 3 thread
- 45° helix angle
- Long-chipping materials from 500 to 1250 N/mm² or 38 HRC

M

DIN 13

	P	M	K	N	S	H	O
THL	●●	●●	●●	●●			

~DIN 371 6HX		D_N	P mm	l_1 js16 mm	L_c mm	l_3 ± 1 mm	d_1 h9 mm	\square h12 mm	l_g mm	N	THL Designation EP2051312
	M 4	0,7	63	7	14,8	4,5	3,4	6	3	★ -M4	
	M 5	0,8	70	8	20,7	6	4,9	8	3	★ -M5	
	M 6	1	80	10	25	6	4,9	8	3	★ -M6	
	M 8	1,25	90	12	35	8	6,2	9	3	★ -M8	
	M 10	1,5	100	15	39	10	8	11	3	★ -M10	

DIN 376 6HX		D_N	P mm	l_1 js16 mm	L_c mm	l_3 ± 1 mm	d_1 h9 mm	\square h12 mm	l_g mm	N	THL Designation EP2056312
	M 12	1,75	110	16	-	9	7	10	4	★ -M12	
	M 16	2	110	20	-	12	9	12	4	★ -M16	
	M 20	2,5	140	25	-	16	12	15	4	★ -M20	
	M 24	3	160	30	-	18	14,5	17	4	★ -M24	

★ New addition to range



Machine tap
Paradur® Eco Plus



$\leq 3 \times D_N$

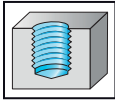

- HSS-E-PM
- Chamfer form C = 2 - 3 thread
- 45° helix angle
- Long-chipping materials from 500 to 1250 N/mm² or 38 HRC
- Suitable for minimum quantity lubrication

M

DIN 13

	P	M	K	N	S	H	O
THL	●	●	●	●			

DIN 371 6HX		D_N	P mm	l_1 js16 mm	L_c mm	l_3 ± 1 mm	d_1 h9 mm	\square h12 mm	l_g mm	N	THL Designation EP2051342
	M 8		1,25	90	12	35	8	6,2	9	3	★ -M8
	M 10		1,5	100	15	39	10	8	11	3	★ -M10

DIN 376 6HX		D_N	P mm	l_1 js16 mm	L_c mm	l_3 ± 1 mm	d_1 h9 mm	\square h12 mm	l_g mm	N	THL Designation EP2056342
	M 12		1,75	110	16	-	9	7	10	4	★ -M12
	M 16		2	110	20	-	12	9	12	4	★ -M16

★ New addition to range



Machine tap Paradur® Eco Plus



$\leq 3 \times D_N$

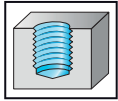

- HSS-E-PM
- Chamfer form C = 2 - 3 thread
- 45° helix angle
- Left-hand thread
- Long-chipping materials from 500 to 1250 N/mm² or 38 HRC

M

DIN 13

	P	M	K	N	S	H	O
THL	●●	●●	●●	●●			

~DIN 371 6HX		D_N	P mm	l_1 js16 mm	L_c mm	l_3 ± 1 mm	d_1 h9 mm	\square h12 mm	l_g mm	N	THL Designation EP2051382
	M 3 LH		0,5	56	6	11	3,5	2,7	6	3	★ -M3
	M 4 LH		0,7	63	7	14,8	4,5	3,4	6	3	★ -M4
	M 5 LH		0,8	70	8	20,7	6	4,9	8	3	★ -M5
	M 6 LH		1	80	10	25	6	4,9	8	3	★ -M6
	M 8 LH		1,25	90	12	35	8	6,2	9	3	★ -M8
	M 10 LH		1,5	100	15	39	10	8	11	3	★ -M10

DIN 376 6HX		D_N	P mm	l_1 js16 mm	L_c mm	l_3 ± 1 mm	d_1 h9 mm	\square h12 mm	l_g mm	N	THL Designation EP2056382
	M 12 LH		1,75	110	16	-	9	7	10	4	★ -M12
	M 14 LH		2	110	20	-	11	9	12	4	★ -M14
	M 16 LH		2	110	20	-	12	9	12	4	★ -M16
	M 18 LH		2,5	125	25	-	14	11	14	4	★ -M18
	M 20 LH		2,5	140	25	-	16	12	15	4	★ -M20

★ New addition to range



Machine tap
Paradur® Eco Plus



$\leq 3 \times D_N$

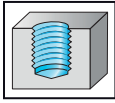

- HSS-E-PM
- Chamfer form E = 1.5 - 2 thread
- 45° helix angle
- Long-chipping materials from 500 to 1250 N/mm² or 38 HRC

M

DIN 13

	P	M	K	N	S	H	O
THL	●●	●●	●●	●●			

~DIN 371 6HX

D_N	P mm	l_1 js16 mm	L_c mm	l_3 ± 1 mm	d_1 h9 mm	\square h12 mm	l_g mm	N	THL Designation EP2051362
M 4	0,7	63	7	14,8	4,5	3,4	6	3	★ -M4
M 5	0,8	70	8	20,7	6	4,9	8	3	★ -M5
M 6	1	80	10	25	6	4,9	8	3	★ -M6
M 8	1,25	90	12	35	8	6,2	9	4	★ -M8
M 10	1,5	100	15	39	10	8	11	4	★ -M10

DIN 376 6HX

D_N	P mm	l_1 js16 mm	L_c mm	l_3 ± 1 mm	d_1 h9 mm	\square h12 mm	l_g mm	N	THL Designation EP2056362
M 12	1,75	110	16	-	9	7	10	4	★ -M12
M 16	2	110	20	-	12	9	12	4	★ -M16
M 20	2,5	140	25	-	16	12	15	4	★ -M20
M 24	3	160	30	-	18	14,5	17	5	★ -M24

★ New addition to range



Machine tap Paradur® X-pert P



$\leq 3 \times D_N$

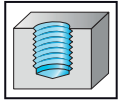

- HSS-E
- Chamfer form C = 2 - 3 thread
- 45° helix angle
- Materials from 200 to 1000 N/mm² or 32 HRC
- For long-chipping materials

M

DIN 13

	P	M	K	N	S	H	O
uncoated	●●			●			●
TiN	●●			●			●

DIN 371 ISO2/6H			l_1 js16 mm	L_c mm	l_3 ± 1 mm	d_1 h9 mm	\square h12 mm	l_g mm	N	uncoated Designation P20519	TiN Designation P2051905
	M 1,6	0,35	40	6	-	2,5	2,1	5	2	★ -M1.6 ¹	
	M 2	0,4	45	4	9	2,8	2,1	5	3	★ -M2	★ -M2
	M 2,2	0,45	45	4	12	2,8	2,1	5	3	★ -M2.2	
	M 2,5	0,45	50	4	12,5	2,8	2,1	5	3	★ -M2.5	★ -M2.5
	M 2,6	0,45	50	4	12,5	2,8	2,1	5	3	★ -M2.6	
	M 3	0,5	56	6	18	3,5	2,7	6	3	★ -M3	★ -M3
	M 3,5	0,6	56	6,5	20	4	3	6	3	★ -M3.5	★ -M3.5
	M 4	0,7	63	7	21	4,5	3,4	6	3	★ -M4	★ -M4
	M 4,5	0,75	70	8	25	6	4,9	8	3	★ -M4.5	
	M 5	0,8	70	8	25	6	4,9	8	3	★ -M5	★ -M5
	M 6	1	80	10	30	6	4,9	8	3	★ -M6	★ -M6
M 7	1	80	10	30	7	5,5	8	3	★ -M7		
M 8	1,25	90	12	35	8	6,2	9	3	★ -M8	★ -M8	
M 10	1,5	100	15	39	10	8	11	3	★ -M10	★ -M10	

¹ without reduced neck after the thread

DIN 376 ISO2/6H			l_1 js16 mm	L_c mm	l_3 ± 1 mm	d_1 h9 mm	\square h12 mm	l_g mm	N	uncoated Designation P20569	TiN Designation P2056905
	M 4	0,7	63	7	-	2,8	2,1	5	3	★ -M4	
	M 5	0,8	70	8	-	3,5	2,7	6	3	★ -M5	
	M 6	1	80	10	-	4,5	3,4	6	3	★ -M6	
	M 8	1,25	90	12	-	6	4,9	8	3	★ -M8	
	M 9	1,25	90	13	-	7	5,5	8	3	★ -M9	
	M 10	1,5	100	15	-	7	5,5	8	3	★ -M10	
	M 11	1,5	100	15	-	8	6,2	9	3	★ -M11	
	M 12	1,75	110	16	-	9	7	10	3	★ -M12	★ -M12
	M 14	2	110	20	-	11	9	12	3	★ -M14	★ -M14
	M 16	2	110	20	-	12	9	12	3	★ -M16	★ -M16
	M 18	2,5	125	25	-	14	11	14	4	★ -M18	★ -M18
	M 20	2,5	140	25	-	16	12	15	4	★ -M20	★ -M20
	M 22	2,5	140	25	-	18	14,5	17	4	★ -M22	
	M 24	3	160	30	-	18	14,5	17	4	★ -M24	★ -M24
	M 27	3	160	30	-	20	16	19	4	★ -M27	
	M 30	3,5	180	35	-	22	18	21	4	★ -M30	★ -M30
	M 33	3,5	180	35	-	25	20	23	4	★ -M33	
	M 36	4	200	40	-	28	22	25	4	★ -M36	
	M 39	4	200	40	-	32	24	27	4	★ -M39	
	M 42	4,5	200	45	-	32	24	27	4	★ -M42	
M 45	4,5	220	45	-	36	29	32	4	★ -M45		
M 48	5	250	50	-	36	29	32	4	★ -M48		
M 52	5	250	50	-	40	32	35	5	★ -M52		
M 56	5,5	250	55	-	40	32	35	5	★ -M56		
M 60	5,5	280	55	-	45	35	38	5	★ -M60		
M 64	6	315	60	-	50	39	42	6	★ -M64		

★ New addition to range



Machine tap Paradur® X-pert P



$\leq 3 \times D_N$

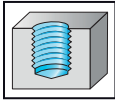

- HSS-E
- Chamfer form C = 2 - 3 thread
- 45° helix angle
- Materials from 200 to 1000 N/mm² or 32 HRC
- For long-chipping materials

M

DIN 13

	P	M	K	N	S	H	O
uncoated	●●			●			●
TiN	●●			●			●

DIN 371 IS03/6G		D_N	P mm	l_1 js16 mm	L_c mm	l_3 ± 1 mm	d_1 h9 mm	\square h12 mm	l_g mm	N	uncoated Designation P20539	TiN Designation P2053905
		M 2	0,4	45	4	9	2,8	2,1	5	3	★ -M2	
		M 2,3	0,4	45	4	12	2,8	2,1	5	3	★ -M2.3	
		M 2,5	0,45	50	4	12,5	2,8	2,1	5	3	★ -M2.5	★ -M2.5
		M 3	0,5	56	6	18	3,5	2,7	6	3	★ -M3	★ -M3
		M 3,5	0,6	56	6,5	20	4	3	6	3	★ -M3.5	
		M 4	0,7	63	7	21	4,5	3,4	6	3	★ -M4	★ -M4
		M 5	0,8	70	8	25	6	4,9	8	3	★ -M5	★ -M5
		M 6	1	80	10	30	6	4,9	8	3	★ -M6	★ -M6
		M 8	1,25	90	12	35	8	6,2	9	3	★ -M8	★ -M8
		M 10	1,5	100	15	39	10	8	11	3	★ -M10	★ -M10

DIN 376 IS03/6G		D_N	P mm	l_1 js16 mm	L_c mm	l_3 ± 1 mm	d_1 h9 mm	\square h12 mm	l_g mm	N	uncoated Designation P20589	TiN Designation P2058905
		M 5	0,8	70	8	-	3,5	2,7	6	3	★ -M5	
		M 6	1	80	10	-	4,5	3,4	6	3	★ -M6	
		M 8	1,25	90	12	-	6	4,9	8	3	★ -M8	
		M 10	1,5	100	15	-	7	5,5	8	3	★ -M10	
		M 12	1,75	110	16	-	9	7	10	3	★ -M12	★ -M12
		M 14	2	110	20	-	11	9	12	3	★ -M14	
		M 16	2	110	20	-	12	9	12	3	★ -M16	★ -M16

★ New addition to range



Machine tap Paradur® X-pert P



$\leq 3 \times D_N$

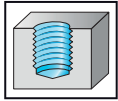

- HSS-E
- Chamfer form C = 2 - 3 thread
- 45° helix angle
- Materials from 200 to 1000 N/mm² or 32 HRC
- For long-chipping materials

M

DIN 13

	P	M	K	N	S	H	O
uncoated	●	●	●	●	●	●	●
TiN	●	●	●	●	●	●	●

DIN 371 7G		D_N	P mm	l_1 js16 mm	L_c mm	l_3 ± 1 mm	d_1 h9 mm	\square h12 mm	l_g mm	N	uncoated Designation P20549	TiN Designation P2054905
	M 2	0,4	45	4	9	2,8	2,1	5	3	★ -M2		
	M 2,5	0,45	50	4	12,5	2,8	2,1	5	3	★ -M2.5		
	M 3	0,5	56	6	18	3,5	2,7	6	3	★ -M3	★ -M3	
	M 4	0,7	63	7	21	4,5	3,4	6	3	★ -M4	★ -M4	
	M 5	0,8	70	8	25	6	4,9	8	3	★ -M5	★ -M5	
	M 6	1	80	10	30	6	4,9	8	3	★ -M6	★ -M6	
	M 8	1,25	90	12	35	8	6,2	9	3	★ -M8	★ -M8	
	M 10	1,5	100	15	39	10	8	11	3	★ -M10	★ -M10	

DIN 376 7G		D_N	P mm	l_1 js16 mm	L_c mm	l_3 ± 1 mm	d_1 h9 mm	\square h12 mm	l_g mm	N	uncoated Designation P20599	TiN Designation P2059905
	M 8	1,25	90	12	-	6	4,9	8	3	★ -M8		
	M 10	1,5	100	15	-	7	5,5	8	3	★ -M10		
	M 12	1,75	110	16	-	9	7	10	3	★ -M12	★ -M12	
	M 16	2	110	20	-	12	9	12	3	★ -M16	★ -M16	
	M 20	2,5	140	25	-	16	12	15	4	★ -M20	★ -M20	
	M 24	3	160	30	-	18	14,5	17	4	★ -M24	★ -M24	

★ New addition to range



Machine tap Paradur® X-pert P



$\leq 3 \times D_N$

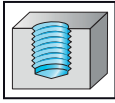

- HSS-E
- Chamfer form C = 2 - 3 thread
- 45° helix angle
- Materials from 200 to 1000 N/mm² or 32 HRC
- For long-chipping materials

M

DIN 13

	P	M	K	N	S	H	O
uncoated	●●	●	●	●	●	●	●

DIN 371 ISO1/4H		D_N	P mm	l_1 js16 mm	L_c mm	l_3 ± 1 mm	d_1 h9 mm	\square h12 mm	l_9 mm	N	uncoated Designation P20509
	M 2	0,4	45	4	9	2,8	2,1	5	3	★ -M2	
	M 2,5	0,45	50	4	12,5	2,8	2,1	5	3	★ -M2.5	
	M 3	0,5	56	6	18	3,5	2,7	6	3	★ -M3	
	M 4	0,7	63	7	21	4,5	3,4	6	3	★ -M4	
	M 5	0,8	70	8	25	6	4,9	8	3	★ -M5	
	M 6	1	80	10	30	6	4,9	8	3	★ -M6	
	M 7	1	80	10	30	7	5,5	8	3	★ -M7	
	M 8	1,25	90	12	35	8	6,2	9	3	★ -M8	
	M 10	1,5	100	15	39	10	8	11	3	★ -M10	

★ New addition to range



Machine tap Paradur® X-pert P

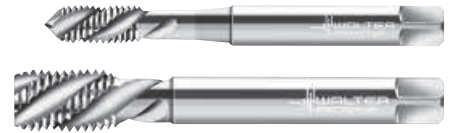

$\leq 3 \times D_N$

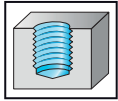

- HSS-E
- Chamfer form C = 2 - 3 thread
- 45° helix angle
- Left-hand thread
- Materials from 200 to 1000 N/mm² or 32 HRC
- For long-chipping materials

M

DIN 13

	P	M	K	N	S	H	O
uncoated	●●			●			●

DIN 371 ISO2/6H			l_1 js16 mm	L_c mm	l_3 ± 1 mm	d_1 h9 mm	\square h12 mm	l_g mm	N	uncoated Designation P205198
D_N	P mm									
M 3 LH	0,5	56	6	18	3,5	2,7	6	3		★ -M3
M 4 LH	0,7	63	7	21	4,5	3,4	6	3		★ -M4
M 5 LH	0,8	70	8	25	6	4,9	8	3		★ -M5
M 6 LH	1	80	10	30	6	4,9	8	3		★ -M6
M 8 LH	1,25	90	12	35	8	6,2	9	3		★ -M8
M 10 LH	1,5	100	15	39	10	8	11	3		★ -M10

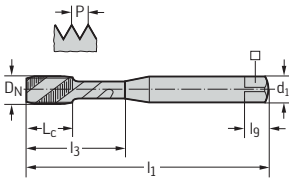

DIN 376 ISO2/6H			l_1 js16 mm	L_c mm	l_3 ± 1 mm	d_1 h9 mm	\square h12 mm	l_g mm	N	uncoated Designation P205698
D_N	P mm									
M 12 LH	1,75	110	16	-	9	7	10	3		★ -M12
M 14 LH	2	110	20	-	11	9	12	3		★ -M14
M 16 LH	2	110	20	-	12	9	12	3		★ -M16
M 20 LH	2,5	140	25	-	16	12	15	4		★ -M20
M 24 LH	3	160	30	-	18	14,5	17	4		★ -M24
M 30 LH	3,5	180	35	-	22	18	21	4		★ -M30

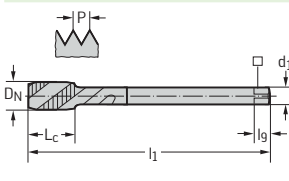

★ New addition to range

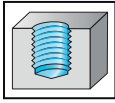

Machine tap Paradur® X-pert P

 $\leq 3,5 \times D_N$

- HSS-E
- Overall length L = long
- Chamfer form C = 2 - 3 thread
- 45° helix angle
- Materials from 200 to 1000 N/mm² or 32 HRC
- For long-chipping materials

M
DIN 13

	P	M	K	N	S	H	O
uncoated	●●			●			●
THL	●●			●			●

~DIN 371 ISO2/6H		D_N	P mm	l_1 js16 mm	L_c mm	l_3 ± 1 mm	d_1 h9 mm	\square h12 mm	l_g mm	N	uncoated Designation P205183	THL Designation P2051832
	M 3	0,5	112	6	18	3,5	2,7	6	3	★ -M3	★ -M3	
	M 4	0,7	112	7	21	4,5	3,4	6	3	★ -M4	★ -M4	
	M 5	0,8	125	8	25	6	4,9	8	3	★ -M5	★ -M5	
	M 6	1	125	10	30	6	4,9	8	3	★ -M6	★ -M6	
	M 8	1,25	140	13	40	8	6,2	9	3	★ -M8	★ -M8	
	M 10	1,5	160	15	50	10	8	11	3	★ -M10	★ -M10	

~DIN 376 ISO2/6H		D_N	P mm	l_1 js16 mm	L_c mm	l_3 ± 1 mm	d_1 h9 mm	\square h12 mm	l_g mm	N	uncoated Designation P205683	THL Designation P2056832
	M 8	1,25	140	12	-	6	4,9	8	3	★ -M8	★ -M8	
	M 10	1,5	160	15	-	7	5,5	8	3	★ -M10	★ -M10	
	M 12	1,75	180	16	-	9	7	10	3	★ -M12	★ -M12	
	M 14	2	180	20	-	11	9	12	3	★ -M14	★ -M14	
	M 16	2	200	20	-	12	9	12	3	★ -M16	★ -M16	
	M 20	2,5	224	25	-	16	12	15	4	★ -M20	★ -M20	

★ New addition to range



Machine tap Paradur® X-pert P



$\leq 3 \times D_N$

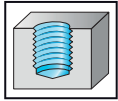

- HSS-E
- Overall length XL = extra long
- Chamfer form C = 2 - 3 thread
- 45° helix angle
- Materials from 200 to 1000 N/mm² or 32 HRC
- For long-chipping materials

M

DIN 13

	P	M	K	N	S	H	O
uncoated	●●			●			●

~DIN 371 ISO2/6H		D_N	P mm	l_1 js16 mm	L_c mm	l_3 ± 1 mm	d_1 h9 mm	\square h12 mm	l_g mm	N	uncoated Designation P2051935
	M 3	0,5	125	6	18	3,5	2,7	6	3	★ -M3	
	M 4	0,7	125	7	21	4,5	3,4	6	3	★ -M4	
	M 5	0,8	140	8	25	6	4,9	8	3	★ -M5	
	M 6	1	160	10	30	6	4,9	8	3	★ -M6	
	M 8	1,25	180	13	35	8	6,2	9	3	★ -M8	
	M 10	1,5	200	15	39	10	8	11	3	★ -M10	

~DIN 376 ISO2/6H		D_N	P mm	l_1 js16 mm	L_c mm	l_3 ± 1 mm	d_1 h9 mm	\square h12 mm	l_g mm	N	uncoated Designation P2056935
	M 8	1,25	180	12	-	6	4,9	8	3	★ -M8	
	M 10	1,5	200	15	-	7	5,5	8	3	★ -M10	
	M 12	1,75	220	16	-	9	7	10	3	★ -M12	
	M 14	2	220	20	-	11	9	12	3	★ -M14	
	M 16	2	220	20	-	12	9	12	3	★ -M16	
	M 18	2,5	250	25	-	14	11	14	4	★ -M18	
	M 20	2,5	280	25	-	16	12	15	4	★ -M20	

★ New addition to range



Machine tap Paradur® X-pert P AZ



$\leq 3 \times D_N$

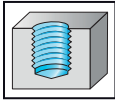

- HSS-E
- Chamfer form C = 2 - 3 thread
- 45° helix angle
- Materials from 200 to 1000 N/mm² or 32 HRC
- For long-chipping materials
- For thin-walled workpieces

M

DIN 13

	P	M	K	N	S	H	O
uncoated	●●			●			●

DIN 371	ISO2/6H	D_N	P mm	l_1 js16 mm	L_c mm	l_3 ± 1 mm	d_1 h9 mm	\square h12 mm	l_g mm	N	uncoated Designation P40519
		M 3	0,5	56	6	18	3,5	2,7	6	3	★ -M3
		M 4	0,7	63	7	21	4,5	3,4	6	3	★ -M4
		M 5	0,8	70	8	25	6	4,9	8	3	★ -M5
		M 6	1	80	10	30	6	4,9	8	3	★ -M6
		M 8	1,25	90	12	35	8	6,2	9	3	★ -M8
		M 10	1,5	100	15	39	10	8	11	3	★ -M10

DIN 376	ISO2/6H	D_N	P mm	l_1 js16 mm	L_c mm	l_3 ± 1 mm	d_1 h9 mm	\square h12 mm	l_g mm	N	uncoated Designation P40569
		M 12	1,75	110	16	-	9	7	10	3	★ -M12

★ New addition to range



Machine tap Paradur® HT



$\leq 3,5 \times D_N$

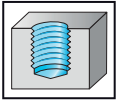

- HSS-E
- Chamfer form C = 2 - 3 thread
- Materials from 500 to 1400 N/mm² or 44 HRC
- For long- and short-chipping materials

M

DIN 13

	P	M	K	N	S	H	O
uncoated	●	●	●	●	●	●	●
TiN	●	●	●	●	●	●	●

DIN 371 ISO2/6H		D_N	P mm	l_1 js16 mm	L_c mm	l_3 ± 1 mm	d_1 h9 mm	\square h12 mm	l_g mm	N	uncoated Designation 203111	TiN Designation 203115
	M 4	0,7	63	12	21	4,5	3,4	6	3		-M4	
	M 5	0,8	70	13	25	6	4,9	8	3	-M5	-M5	
	M 6	1	80	15	30	6	4,9	8	3	-M6	-M6	
	M 8	1,25	90	18	35	8	6,2	9	3	-M8	-M8	
	M 10	1,5	100	20	39	10	8	11	3	-M10	-M10	

DIN 376 ISO2/6H		D_N	P mm	l_1 js16 mm	L_c mm	l_3 ± 1 mm	d_1 h9 mm	\square h12 mm	l_g mm	N	uncoated Designation 203611	TiN Designation 203615
	M 12	1,75	110	23	-	9	7	10	3	-M12	-M12	
	M 14	2	110	25	-	11	9	12	3		-M14	
	M 16	2	110	25	-	12	9	12	3		-M16	
	M 20	2,5	140	30	-	16	12	15	3		-M20	
	M 22	2,5	140	30	-	18	14,5	17	3		-M22	
	M 24	3	160	36	-	18	14,5	17	4		-M24	
	M 27	3	160	36	-	20	16	19	4		★ -M27	
	M 30	3,5	180	42	-	22	18	21	4		★ -M30	
	M 36	4	200	48	-	28	22	25	5		★ -M36	

★ New addition to range



Machine tap Paradur® Short Chip HT



$\leq 3,5 \times D_N$

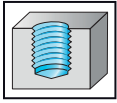

- HSS-E
- Chamfer form C = 2 - 3 thread
- 15° helix angle
- Reduced helix to 9° (uncoated)
- Materials from 800 to 1250 N/mm² or 38 HRC
- For long-chipping materials

M

DIN 13

	P	M	K	N	S	H	O
THL	●	●	●	●	●	●	●

DIN 371 6HX		D_N	P mm	l_1 js16 mm	L_c mm	l_3 ± 1 mm	d_1 h9 mm	\square h12 mm	l_9 mm	N	THL Designation 20410TR
	M 5	0,8	70	8	25	6	4,9	8	3	★ -M5	
	M 6	1	80	10	30	6	4,9	8	3	★ -M6	
	M 8	1,25	90	12	35	8	6,2	9	3	★ -M8	
	M 10	1,5	100	15	39	10	8	11	3	★ -M10	

DIN 376 6HX		D_N	P mm	l_1 js16 mm	L_c mm	l_3 ± 1 mm	d_1 h9 mm	\square h12 mm	l_9 mm	N	THL Designation 20460TR
	M 12	1,75	110	16	-	9	7	10	3	★ -M12	

★ New addition to range



Machine tap Paradur® X-pert M



$\leq 2,5 \times D_N$

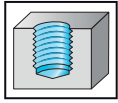

- HSS-E
- Chamfer form C = 2 - 3 thread
- 40° helix angle
- Higher positioned core
- Materials from 350 to 1200 N/mm² or 36 HRC
- For long-chipping materials

M

DIN 13

	P	M	K	N	S	H	O
vap	●	●●	■	■	■	■	■
TiN	●	●●	■	■	■	■	■
TiCN	●	●●	■	■	■	■	■

DIN 371 6HX											VAP Designation M20513	TiN Designation M2051305	TiCN Designation M2051306
D _N	P mm	l ₁ js16 mm	L _c mm	l ₃ ±1 mm	d ₁ h9 mm	□ h12 mm	l _g mm	N					
M 1,6	0,35	40	6	-	2,5	2,1	5	3		★ -M1.6 ^{1 4}			
M 1,7	0,35	40	6	-	2,5	2,1	5	3		★ -M1.7 ^{1 4}			
M 1,8	0,35	40	6	-	2,5	2,1	5	3		★ -M1.8 ^{1 4}			
M 2	0,4	45	4	9	2,8	2,1	5	3		★ -M2 ⁴	★ -M2 ⁴	★ -M2 ⁴	
M 2,5	0,45	50	4	12,5	2,8	2,1	5	3		★ -M2.5 ⁴	★ -M2.5 ⁴	★ -M2.5 ⁴	
M 3	0,5	56	6	18	3,5	2,7	6	3		★ -M3	★ -M3	★ -M3	
M 3,5	0,6	56	6,5	20	4	3	6	3		★ -M3.5			
M 4	0,7	63	7	21	4,5	3,4	6	3		★ -M4	★ -M4	★ -M4	
M 4,5	0,75	70	8	25	6	4,9	8	3		★ -M4.5			
M 5	0,8	70	8	25	6	4,9	8	3		★ -M5	★ -M5	★ -M5	
M 6	1	80	10	30	6	4,9	8	3		★ -M6	★ -M6	★ -M6	
M 7	1	80	10	30	7	5,5	8	3		★ -M7			
M 8	1,25	90	12	35	8	6,2	9	3		★ -M8	★ -M8	★ -M8	
M 10	1,5	100	15	39	10	8	11	3		★ -M10	★ -M10	★ -M10	

¹ without reduced neck after the thread

⁴ without thread taper

DIN 376 6HX											VAP Designation M20563	TiN Designation M2056305	TiCN Designation M2056306
D _N	P mm	l ₁ js16 mm	L _c mm	l ₃ ±1 mm	d ₁ h9 mm	□ h12 mm	l _g mm	N					
M 6	1	80	10	-	4,5	3,4	6	3		★ -M6			★ -M6
M 8	1,25	90	12	-	6	4,9	8	3		★ -M8			★ -M8
M 10	1,5	100	15	-	7	5,5	8	3		★ -M10			★ -M10
M 12	1,75	110	16	-	9	7	10	4		★ -M12	★ -M12		★ -M12
M 14	2	110	20	-	11	9	12	4		★ -M14			
M 16	2	110	20	-	12	9	12	4		★ -M16	★ -M16		★ -M16
M 18	2,5	125	25	-	14	11	14	4		★ -M18			
M 20	2,5	140	25	-	16	12	15	4		★ -M20	★ -M20		★ -M20
M 22	2,5	140	25	-	18	14,5	17	4		★ -M22			
M 24	3	160	30	-	18	14,5	17	4		★ -M24			★ -M24
M 27	3	160	30	-	20	16	19	5		★ -M27			
M 30	3,5	180	35	-	22	18	21	5		★ -M30			★ -M30
M 33	3,5	180	35	-	25	20	23	5		★ -M33			
M 36	4	200	40	-	28	22	25	5		★ -M36			
M 42	4,5	200	45	-	32	24	27	5		★ -M42			

★ New addition to range



Machine tap Paradur® X-pert M



$\leq 2,5 \times D_N$

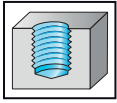

- HSS-E
- Chamfer form C = 2 - 3 thread
- 40° helix angle
- Higher positioned core
- Materials from 350 to 1200 N/mm² or 36 HRC
- For long-chipping materials

M
DIN 13

	P	M	K	N	S	H	O
vap	●	●●	●	●	●	●	●
TiCN	●	●●	●	●	●	●	●

DIN 371 6GX		D_N	P mm	l_1 js16 mm	L_c mm	l_3 ± 1 mm	d_1 h9 mm	\square h12 mm	l_g mm	N	VAP Designation M20533	TiCN Designation M2053306
		M 3	0,5	56	6	18	3,5	2,7	6	3	★ -M3	★ -M3
		M 4	0,7	63	7	21	4,5	3,4	6	3	★ -M4	★ -M4
		M 5	0,8	70	8	25	6	4,9	8	3	★ -M5	★ -M5
		M 6	1	80	10	30	6	4,9	8	3	★ -M6	★ -M6
		M 8	1,25	90	12	35	8	6,2	9	3	★ -M8	★ -M8
		M 10	1,5	100	15	39	10	8	11	3	★ -M10	★ -M10

★ New addition to range



Machine tap Paradur® X-pert M



$\leq 2,5 \times D_N$

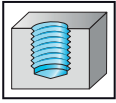

- HSS-E
- Overall length XL = extra long
- Chamfer form C = 2 - 3 thread
- 40° helix angle
- Materials from 350 to 1200 N/mm² or 36 HRC
- For long-chipping materials

M

DIN 13

	P	M	K	N	S	H	O
THL	●	●●	■	■	■	■	■

~DIN 371 6HX		D_N	P mm	l_1 js16 mm	L_c mm	l_3 ± 1 mm	d_1 h9 mm	\square h12 mm	l_g mm	N	THL Designation M2051332
		M 4	0,7	125	7	21	4,5	3,4	6	3	★ -M4
		M 5	0,8	140	8	25	6	4,9	8	3	★ -M5
		M 6	1	160	10	30	6	4,9	8	3	★ -M6

~DIN 376 6HX		D_N	P mm	l_1 js16 mm	L_c mm	l_3 ± 1 mm	d_1 h9 mm	\square h12 mm	l_g mm	N	THL Designation M2056332
		M 8	1,25	180	12	-	6	4,9	8	3	★ -M8
		M 10	1,5	200	15	-	7	5,5	8	3	★ -M10
		M 12	1,75	220	16	-	9	7	10	4	★ -M12
		M 16	2	220	20	-	12	9	12	4	★ -M16
		M 20	2,5	280	25	-	16	12	15	4	★ -M20

★ New addition to range



Machine tap Paradur® X-pert K



$\leq 3 \times D_N$

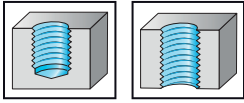

- HSS-E-PM
- Chamfer form C = 2 - 3 thread
- Materials from 100 to 1000 N/mm² or 32 HRC
- For short-chipping materials

M

DIN 13

	P	M	K	N	S	H	O
TAPT			●●	●			

DIN 371 6HX		D_N	P mm	l_1 js16 mm	L_c mm	l_3 ± 1 mm	d_1 h9 mm	\square h12 mm	l_g mm	N	TAPT Designation K2031407
	M 3		0,5	56	9	18	3,5	2,7	6	3	★ -M3
	M 4		0,7	63	11	21	4,5	3,4	6	3	★ -M4
	M 5		0,8	70	13	25	6	4,9	8	3	★ -M5
	M 6		1	80	15	30	6	4,9	8	3	★ -M6
	M 8		1,25	90	18	35	8	6,2	9	4	★ -M8
	M 10		1,5	100	20	39	10	8	11	4	★ -M10

DIN 376 6HX		D_N	P mm	l_1 js16 mm	L_c mm	l_3 ± 1 mm	d_1 h9 mm	\square h12 mm	l_g mm	N	TAPT Designation K2036407
	M 12		1,75	110	23	-	9	7	10	4	★ -M12
	M 14		2	110	25	-	11	9	12	4	★ -M14
	M 16		2	110	25	-	12	9	12	4	★ -M16
	M 20		2,5	140	30	-	16	12	15	4	★ -M20

★ New addition to range



Machine tap Paradur® X-pert N

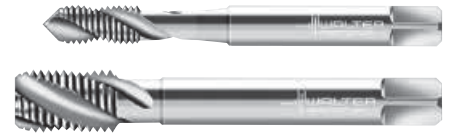

$\leq 3 \times D_N$

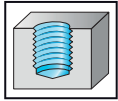

- HSS-E
- Chamfer form C = 2 - 3 thread
- 35° helix angle
- Materials from 200 to 700 N/mm² or 14 HRC
- For long-chipping materials

M

DIN 13

	P	M	K	N	S	H	O
uncoated				●●	●		●

DIN 371	ISO2/6H										uncoated Designation N20516
D_N	P mm	l_1 js16 mm	L_c mm	$l_3 \pm 1$ mm	d_1 h9 mm	\square h12 mm	l_g mm	N			
M 1,6	0,35	40	6	-	2,5	2,1	5	2		★ -M1,6 ¹	
M 2	0,4	45	4	9	2,8	2,1	5	2		★ -M2	
M 2,3	0,4	45	4	12	2,8	2,1	5	2		★ -M2,3	
M 2,5	0,45	50	4	12,5	2,8	2,1	5	2		★ -M2,5	
M 3	0,5	56	6	18	3,5	2,7	6	2		★ -M3	
M 3,5	0,6	56	6,5	20	4	3	6	2		★ -M3,5	
M 4	0,7	63	7	21	4,5	3,4	6	2		★ -M4	
M 5	0,8	70	8	25	6	4,9	8	2		★ -M5	
M 6	1	80	10	30	6	4,9	8	2		★ -M6	
M 8	1,25	90	12	35	8	6,2	9	2		★ -M8	
M 10	1,5	100	15	39	10	8	11	2		★ -M10	

¹ without reduced neck after the thread

DIN 376	ISO2/6H										uncoated Designation N20566
D_N	P mm	l_1 js16 mm	L_c mm	$l_3 \pm 1$ mm	d_1 h9 mm	\square h12 mm	l_g mm	N			
M 6	1	80	10	-	4,5	3,4	6	2		★ -M6	
M 8	1,25	90	12	-	6	4,9	8	2		★ -M8	
M 10	1,5	100	15	-	7	5,5	8	2		★ -M10	
M 12	1,75	110	16	-	9	7	10	3		★ -M12	
M 14	2	110	20	-	11	9	12	3		★ -M14	
M 16	2	110	20	-	12	9	12	3		★ -M16	
M 20	2,5	140	25	-	16	12	15	3		★ -M20	

★ New addition to range



Machine tap Paradur® X-pert N



$\leq 3 \times D_N$

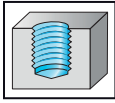

- HSS-E
- Chamfer form C = 2 - 3 thread
- 35° helix angle
- Materials from 200 to 700 N/mm² or 14 HRC
- For long-chipping materials

M

DIN 13

	P	M	K	N	S	H	O
uncoated				●●	●		●

DIN 371	ISO2/6H	D_N	P mm	l_1 js16 mm	L_c mm	l_3 ± 1 mm	d_1 h9 mm	\square h12 mm	l_9 mm	N	uncoated Designation N205166
		M 3	0,5	56	6	18	3,5	2,7	6	3	★ -M3
		M 4	0,7	63	7	21	4,5	3,4	6	3	★ -M4
		M 5	0,8	70	8	25	6	4,9	8	3	★ -M5
		M 6	1	80	10	30	6	4,9	8	3	★ -M6
		M 7	1	80	10	30	7	5,5	8	3	★ -M7
		M 8	1,25	90	12	35	8	6,2	9	3	★ -M8
		M 10	1,5	100	15	39	10	8	11	3	★ -M10

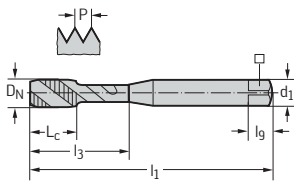

★ New addition to range



Machine tap Paradur® X-pert N



$\leq 3 \times D_N$

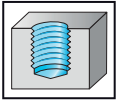

- HSS-E
- Chamfer form C = 2 - 3 thread
- 35° helix angle
- Materials from 200 to 700 N/mm² or 14 HRC
- For long-chipping materials

M

DIN 13

	P	M	K	N	S	H	O
uncoated				●●	●		●

DIN 371	ISO3/6G	D_N	P mm	l_1 js16 mm	L_c mm	l_3 ± 1 mm	d_1 h9 mm	\square h12 mm	l_g mm	N	uncoated Designation N20536
		M 2	0,4	45	4	9	2,8	2,1	5	2	★ -M2
		M 2,5	0,45	50	4	12,5	2,8	2,1	5	2	★ -M2.5
		M 3	0,5	56	6	18	3,5	2,7	6	2	★ -M3
		M 4	0,7	63	7	21	4,5	3,4	6	2	★ -M4
		M 5	0,8	70	8	25	6	4,9	8	2	★ -M5
		M 6	1	80	10	30	6	4,9	8	2	★ -M6
		M 8	1,25	90	12	35	8	6,2	9	2	★ -M8

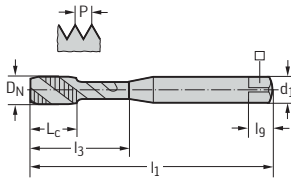

★ New addition to range



Machine tap Prototex® Eco Plus

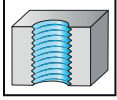

 $\leq 3,5 \times D_N$

- HSS-E-PM
- Chamfer form B = 3.5 - 5 thread
- Higher positioned core
- Materials from 500 to 1350 N/mm² or 42 HRC
- For long-chipping materials

MF

DIN 13

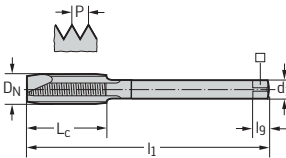
	P	M	K	N	S	H	O
THL	●●	●●	●●	●●			

DIN 374 6HX	D_N	P mm	l_1 js16 mm	L_c mm	d_1 h9 mm	\square h12 mm	l_g mm	N	THL Designation EP2126302
	M 6	0,75	80	15	4,5	3,4	6	3	★ -M6X0.75
	M 8	1	90	18	6	4,9	8	3	★ -M8X1
	M 10	1	90	20	7	5,5	8	3	★ -M10X1
	M 10	1,25	100	20	7	5,5	8	3	★ -M10X1.25
	M 12	1	100	21	9	7	10	4	★ -M12X1
	M 12	1,25	100	21	9	7	10	4	★ -M12X1.25
	M 12	1,5	100	21	9	7	10	4	★ -M12X1.5
	M 14	1,5	100	21	11	9	12	4	★ -M14X1.5
	M 16	1,5	100	21	12	9	12	4	★ -M16X1.5
	M 18	1,5	110	24	14	11	14	4	★ -M18X1.5
	M 20	1,5	125	24	16	12	15	4	★ -M20X1.5
	M 22	1,5	125	24	18	14,5	17	4	★ -M22X1.5

★ New addition to range



Machine tap Prototex® Eco Plus



$\leq 3,5 \times D_N$

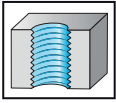

- HSS-E-PM
- Chamfer form B = 3.5 - 5 thread
- Higher positioned core
- Materials from 500 to 1350 N/mm² or 42 HRC
- For long-chipping materials
- Suitable for minimum quantity lubrication

MF

DIN 13

	P	M	K	N	S	H	O
THL	●●	●●	●●	●●			

DIN 374 6HX		D_N	P mm	l_1 js16 mm	L_c mm	d_1 h9 mm	\square h12 mm	l_g mm	N	THL Designation EP2126342
	M 8	1	90	18	6	4,9	8	3	★ -M8X1	
	M 10	1	90	20	7	5,5	8	3	★ -M10X1	
	M 10	1,25	100	20	7	5,5	8	3	★ -M10X1.25	
	M 12	1	100	21	9	7	10	4	★ -M12X1	
	M 12	1,25	100	21	9	7	10	4	★ -M12X1.25	
	M 12	1,5	100	21	9	7	10	4	★ -M12X1.5	
	M 14	1,5	100	21	11	9	12	4	★ -M14X1.5	
	M 16	1,5	100	21	12	9	12	4	★ -M16X1.5	
	M 18	1,5	110	24	14	11	14	4	★ -M18X1.5	
	M 20	1,5	125	24	16	12	15	4	★ -M20X1.5	

★ New addition to range



Machine tap Prototex® X-pert P



$\leq 3 \times D_N$

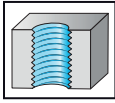

- HSS-E
- Chamfer form B = 3.5 - 5 thread
- Materials from 200 to 1000 N/mm² or 32 HRC
- For long-chipping materials

MF

DIN 13

	P	M	K	N	S	H	O
uncoated	●	●	●	●	●	●	●

DIN 371	ISO2/6H	D_N	P mm	l_1 js16 mm	L_c mm	l_3 ± 1 mm	d_1 h9 mm	\square h12 mm	l_9 mm	N	uncoated Designation P21210
		M 2	0,25	45	6	9	2,8	2,1	5	2	★ -M2X0.25
		M 2,2	0,25	45	7	12	2,8	2,1	5	2	★ -M2.2X0.25
		M 2,3	0,25	45	7	12	2,8	2,1	5	2	★ -M2.3X0.25
		M 2,5	0,35	50	8	12,5	2,8	2,1	5	2	★ -M2.5X0.35
		M 3	0,25	56	6	18	3,5	2,7	6	2	★ -M3X0.25
		M 3	0,35	56	9	18	3,5	2,7	6	2	★ -M3X0.35
		M 3,5	0,35	56	11	20	4	3	6	2	★ -M3.5X0.35
		M 4	0,35	63	12	21	4,5	3,4	6	2	★ -M4X0.35
		M 4	0,5	63	12	21	4,5	3,4	6	2	★ -M4X0.5
		M 4,5	0,5	70	13	25	6	4,9	8	2	★ -M4.5X0.5
		M 5	0,5	70	13	25	6	4,9	8	3	★ -M5X0.5
		M 5	0,75	70	13	25	6	4,9	8	3	★ -M5X0.75
		M 6	0,5	80	15	30	6	4,9	8	3	★ -M6X0.5
		M 6	0,75	80	15	30	6	4,9	8	3	★ -M6X0.75
		M 7	0,75	80	15	30	7	5,5	8	3	★ -M7X0.75
		M 8	1	90	18	35	8	6,2	9	3	★ -M8X1
		M 10	1	90	20	39	10	8	11	3	★ -M10X1

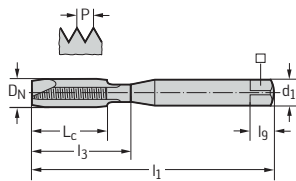

★ New addition to range



Machine tap Prototex® X-pert P



$\leq 3 \times D_N$

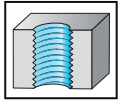

- HSS-E
- Chamfer form B = 3.5 - 5 thread
- Materials from 200 to 1000 N/mm² or 32 HRC
- For long-chipping materials

MF

DIN 13

	P	M	K	N	S	H	O
uncoated	●●			●			●
TiN	●●			●			●

DIN 374	ISO2/6H	D_N	P mm	l_1 js16 mm	L_c mm	d_1 h9 mm	\square h12 mm	l_g mm	N	uncoated Designation P21360	TiN Designation P2136005
		M 4	0,5	63	12	2,8	2,1	5	3	★ -M4X0.5	
		M 5	0,5	70	13	3,5	2,7	6	3	★ -M5X0.5	★ -M5X0.5
		M 6	0,5	80	15	4,5	3,4	6	3	★ -M6X0.5	★ -M6X0.5
		M 6	0,75	80	15	4,5	3,4	6	3	★ -M6X0.75	★ -M6X0.75
		M 8	0,5	80	15	6	4,9	8	3	★ -M8X0.5	★ -M8X0.5
		M 8	0,75	80	15	6	4,9	8	3	★ -M8X0.75	★ -M8X0.75
		M 8	1	90	18	6	4,9	8	3	★ -M8X1	★ -M8X1
		M 9	1	90	18	7	5,5	8	3	★ -M9X1	
		M 10	0,5	90	20	7	5,5	8	3	★ -M10X0.5	
		M 10	0,75	90	20	7	5,5	8	3	★ -M10X0.75	
		M 10	1	90	20	7	5,5	8	3	★ -M10X1	★ -M10X1
		M 10	1,25	100	20	7	5,5	8	3	★ -M10X1.25	★ -M10X1.25
		M 12	0,5	100	21	9	7	10	4	★ -M12X0.5	
		M 12	1	100	21	9	7	10	4	★ -M12X1	★ -M12X1
		M 12	1,25	100	21	9	7	10	4	★ -M12X1.25	
		M 12	1,5	100	21	9	7	10	4	★ -M12X1.5	★ -M12X1.5
		M 14	1	100	21	11	9	12	4	★ -M14X1	
		M 14	1,25	100	21	11	9	12	4	★ -M14X1.25	
		M 14	1,5	100	21	11	9	12	4	★ -M14X1.5	★ -M14X1.5
		M 16	1	100	21	12	9	12	4	★ -M16X1	
		M 16	1,5	100	21	12	9	12	4	★ -M16X1.5	★ -M16X1.5
		M 18	1	110	24	14	11	14	4	★ -M18X1	
		M 18	1,5	110	24	14	11	14	4	★ -M18X1.5	★ -M18X1.5
		M 18	2	125	30	14	11	14	4	★ -M18X2	
		M 20	1	125	24	16	12	15	4	★ -M20X1	
		M 20	1,5	125	24	16	12	15	4	★ -M20X1.5	★ -M20X1.5
		M 20	2	140	30	16	12	15	4	★ -M20X2	
		M 22	1	125	24	18	14,5	17	4	★ -M22X1	
		M 22	1,5	125	24	18	14,5	17	4	★ -M22X1.5	★ -M22X1.5
		M 22	2	140	26	18	14,5	17	4	★ -M22X2	
		M 24	1	140	26	18	14,5	17	4	★ -M24X1	
		M 24	1,5	140	26	18	14,5	17	4	★ -M24X1.5	★ -M24X1.5
		M 24	2	140	26	18	14,5	17	4	★ -M24X2	★ -M24X2
		M 25	1,5	140	26	18	14,5	17	4	★ -M25X1.5	
		M 26	1,5	140	26	18	14,5	17	4	★ -M26X1.5	
		M 27	1	140	26	20	16	19	4	★ -M27X1	
		M 27	1,5	140	26	20	16	19	4	★ -M27X1.5	
		M 27	2	140	26	20	16	19	4	★ -M27X2	★ -M27X2
		M 28	1,5	140	26	20	16	19	4	★ -M28X1.5	
		M 30	1	150	26	22	18	21	4	★ -M30X1	
		M 30	1,5	150	26	22	18	21	4	★ -M30X1.5	★ -M30X1.5
		M 30	2	150	26	22	18	21	4	★ -M30X2	★ -M30X2
		M 32	1,5	150	26	22	18	21	4	★ -M32X1.5	
		M 32	2	150	26	22	18	21	4	★ -M32X2	
		M 33	1,5	160	28	25	20	23	4	★ -M33X1.5	
		M 33	2	160	28	25	20	23	4	★ -M33X2	
		M 35	1,5	170	28	28	22	25	4	★ -M35X1.5	

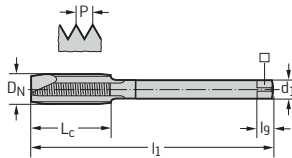

Continued

★ New addition to range



Machine tap Prototex® X-pert P

 $\leq 3 \times D_N$

Continued

	P	M	K	N	S	H	O
uncoated	●●			●			●
TiN	●●			●			●

DIN 374 ISO2/6H	D_N	P mm	l_1 js16 mm	L_c mm	d_1 h9 mm	\square h12 mm	l_g mm	N	uncoated	TIN
									Designation P21360	Designation P2136005
	M 36	1,5	170	28	28	22	25	4	★ -M36X1.5	
	M 36	2	170	28	28	22	25	4	★ -M36X2	
	M 36	3	200	39	28	22	25	4	★ -M36X3	
	M 38	1,5	170	28	28	22	25	5	★ -M38X1.5	
	M 39	2	170	28	32	24	27	4	★ -M39X2	
	M 40	1,5	170	28	32	24	27	5	★ -M40X1.5	
	M 40	2	170	28	32	24	27	4	★ -M40X2	
	M 42	1,5	170	28	32	24	27	5	★ -M42X1.5	
	M 42	2	170	28	32	24	27	4	★ -M42X2	
	M 42	3	200	42	32	24	27	4	★ -M42X3	
	M 45	1,5	180	28	36	29	32	5	★ -M45X1.5	
	M 48	1,5	190	28	36	29	32	5	★ -M48X1.5	
	M 48	3	225	45	36	29	32	4	★ -M48X3	
	M 50	1,5	190	28	36	29	32	5	★ -M50X1.5	

★ New addition to range



Machine tap Prototex® X-pert P



$\leq 3 \times D_N$

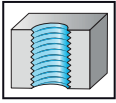

- HSS-E
- Chamfer form B = 3.5 - 5 thread
- Left-hand thread
- Materials from 200 to 1000 N/mm² or 32 HRC
- For long-chipping materials

MF

DIN 13

	P	M	K	N	S	H	O
uncoated	●●			●			●

DIN 374	ISO2/6H	D_N	P mm	l_1 js16 mm	L_c mm	d_1 h9 mm	\square h12 mm	l_g mm	N	uncoated Designation P212608
		M 8 LH	1	90	18	6	4,9	8	3	★ -M8X1
		M 10 LH	1	90	20	7	5,5	8	3	★ -M10X1
		M 12 LH	1	100	21	9	7	10	4	★ -M12X1
		M 12 LH	1,5	100	21	9	7	10	4	★ -M12X1.5
		M 14 LH	1,5	100	21	11	9	12	4	★ -M14X1.5
		M 16 LH	1	100	21	12	9	12	4	★ -M16X1
		M 16 LH	1,5	100	21	12	9	12	4	★ -M16X1.5
		M 18 LH	1,5	110	24	14	11	14	4	★ -M18X1.5
		M 20 LH	1,5	125	24	16	12	15	4	★ -M20X1.5

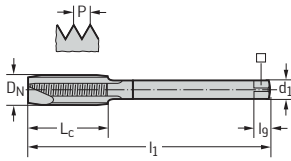

★ New addition to range

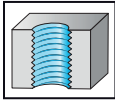

Machine tap Prototex® X-pert P

 $\leq 3 \times D_N$

- HSS-E
- Chamfer form B = 3.5 - 5 thread
- Materials from 200 to 1000 N/mm² or 32 HRC
- For long-chipping materials

MF

DIN 13

	P	M	K	N	S	H	O
uncoated	●●			●			●
TiN	●●			●			●

DIN 374	ISO3/6G	D_N	P mm	l_1 js16 mm	L_c mm	d_1 h9 mm	\square h12 mm	l_g mm	N	uncoated Designation P21380	TiN Designation P2138005
		M 4	0,5	63	12	2,8	2,1	5	3	★ -M4X0,5	
		M 5	0,5	70	13	3,5	2,7	6	3	★ -M5X0,5	
		M 6	0,5	80	15	4,5	3,4	6	3	★ -M6X0,5	
		M 6	0,75	80	15	4,5	3,4	6	3	★ -M6X0,75	
		M 8	0,75	80	15	6	4,9	8	3	★ -M8X0,75	
		M 8	1	90	18	6	4,9	8	3	★ -M8X1	★ -M8X1
		M 10	1	90	20	7	5,5	8	3	★ -M10X1	★ -M10X1
		M 10	1,25	100	20	7	5,5	8	3	★ -M10X1,25	
		M 12	1	100	21	9	7	10	4	★ -M12X1	★ -M12X1
		M 12	1,25	100	21	9	7	10	4	★ -M12X1,25	
		M 12	1,5	100	21	9	7	10	4	★ -M12X1,5	★ -M12X1,5
		M 14	1,5	100	21	11	9	12	4	★ -M14X1,5	★ -M14X1,5
		M 16	1,5	100	21	12	9	12	4	★ -M16X1,5	★ -M16X1,5
		M 18	1,5	110	24	14	11	14	4	★ -M18X1,5	
		M 20	1,5	125	24	16	12	15	4	★ -M20X1,5	
		M 22	1,5	125	24	18	14,5	17	4	★ -M22X1,5	
		M 24	1,5	140	26	18	14,5	17	4	★ -M24X1,5	

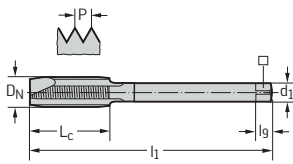

★ New addition to range



Machine tap Prototex® X-pert M



$\leq 3 \times D_N$

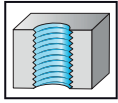

- HSS-E
- Chamfer form B = 3.5 - 5 thread
- Higher positioned core
- Materials from 350 to 1200 N/mm² or 36 HRC
- For long-chipping materials

MF

DIN 13

	P	M	K	N	S	H	O
TiN	●	●●	■	■	■	■	■
vap	●	●●	■	■	■	■	■

DIN 371 6HX		l_1 js16 mm	L_c mm	l_3 ± 1 mm	d_1 h9 mm	\square h12 mm	l_g mm	N	TiN Designation M2121305
D_N	P mm								
M 5	0,5	70	13	25	6	4,9	8	3	★ -M5X0.5
M 6	0,5	80	15	30	6	4,9	8	3	★ -M6X0.5
M 6	0,75	80	15	30	6	4,9	8	3	★ -M6X0.75

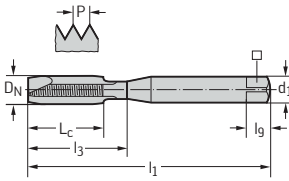

DIN 374 6HX		l_1 js16 mm	L_c mm	l_3 ± 1 mm	d_1 h9 mm	\square h12 mm	l_g mm	N	VAP Designation M21263	TiN Designation M2126305
D_N	P mm									
M 8	0,5	80	15	-	6	4,9	8	3	★ -M8X0.5	★ -M8X0.5
M 8	0,75	80	15	-	6	4,9	8	3	★ -M8X0.75	★ -M8X0.75
M 8	1	90	18	-	6	4,9	8	3	★ -M8X1	★ -M8X1
M 10	0,75	90	20	-	7	5,5	8	3	★ -M10X0.75	
M 10	1	90	20	-	7	5,5	8	3	★ -M10X1	★ -M10X1
M 10	1,25	100	20	-	7	5,5	8	3	★ -M10X1.25	★ -M10X1.25
M 12	1	100	21	-	9	7	10	4	★ -M12X1	
M 12	1,25	100	21	-	9	7	10	4	★ -M12X1.25	
M 12	1,5	100	21	-	9	7	10	4	★ -M12X1.5	★ -M12X1.5
M 14	1	100	21	-	11	9	12	4	★ -M14X1	
M 14	1,5	100	21	-	11	9	12	4	★ -M14X1.5	★ -M14X1.5
M 16	1	100	21	-	12	9	12	4	★ -M16X1	
M 16	1,5	100	21	-	12	9	12	4	★ -M16X1.5	★ -M16X1.5
M 18	1,5	110	24	-	14	11	14	4	★ -M18X1.5	★ -M18X1.5
M 20	1,5	125	24	-	16	12	15	4	★ -M20X1.5	★ -M20X1.5
M 22	1,5	125	24	-	18	14,5	17	4	★ -M22X1.5	
M 24	1,5	140	26	-	18	14,5	17	4	★ -M24X1.5	

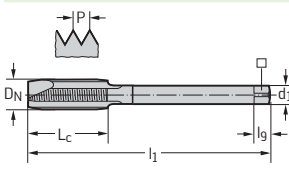

★ New addition to range



Machine tap Prototex® X-pert M



$\leq 3 \times D_N$

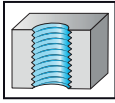

- HSS-E
- Chamfer form B = 3.5 - 5 thread
- Higher positioned core
- Materials from 350 to 1200 N/mm² or 36 HRC
- For long-chipping materials

MF

DIN 13

	P	M	K	N	S	H	O
TiN	●	●●	■	■	■	■	■

DIN 374 6GX		D _N	P mm	l ₁ js16 mm	L _c mm	d ₁ h9 mm	□ h12 mm	l _g mm	N	TiN Designation M2128305
	M 12	1,5	100	21	9	7	10	4	★ -M12X1.5	
	M 14	1,5	100	21	11	9	12	4	★ -M14X1.5	
	M 16	1,5	100	21	12	9	12	4	★ -M16X1.5	
	M 20	1,5	125	24	16	12	15	4	★ -M20X1.5	
	M 24	1,5	140	26	18	14,5	17	4	★ -M24X1.5	

★ New addition to range



Machine tap Paradur® Eco Plus



$\leq 3 \times D_N$

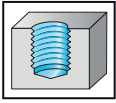

- HSS-E-PM
- Chamfer form C = 2 - 3 thread
- 45° helix angle
- Long-chipping materials from 500 to 1250 N/mm² or 38 HRC

MF

DIN 13

	P	M	K	N	S	H	O
THL	●●	●●	●●	●●			

DIN 374 6HX		D_N	P mm	l_1 js16 mm	L_c mm	d_1 h9 mm	\square h12 mm	l_g mm	N	THL Designation EP2156302
	M 6	0,75	80	10	4,5	3,4	6	3	★	-M6X0.75
	M 8	1	90	12	6	4,9	8	3	★	-M8X1
	M 10	1	90	12	7	5,5	8	3	★	-M10X1
	M 10	1,25	100	15	7	5,5	8	3	★	-M10X1.25
	M 12	1	100	13	9	7	10	4	★	-M12X1
	M 12	1,25	100	13	9	7	10	4	★	-M12X1.25
	M 12	1,5	100	13	9	7	10	4	★	-M12X1.5
	M 14	1,5	100	15	11	9	12	4	★	-M14X1.5
	M 16	1,5	100	15	12	9	12	4	★	-M16X1.5
	M 18	1,5	110	17	14	11	14	4	★	-M18X1.5
	M 20	1,5	125	17	16	12	15	4	★	-M20X1.5
M 22	1,5	125	18	18	14,5	17	4	★	-M22X1.5	

★ New addition to range



Machine tap Paradur® Eco Plus



$\leq 3 \times D_N$

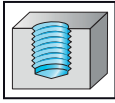

- HSS-E-PM
- Chamfer form E = 1.5 - 2 thread
- 45° helix angle
- Long-chipping materials from 500 to 1250 N/mm² or 38 HRC

MF

DIN 13

	P	M	K	N	S	H	O
THL	●●	●●	●●	●●			

DIN 374 6HX		D_N	P mm	l_1 js16 mm	L_c mm	d_1 h9 mm	\square h12 mm	l_g mm	N	THL Designation EP2156362
	M 8		1	90	12	6	4,9	8	4	★ -M8X1
	M 10		1	90	12	7	5,5	8	4	★ -M10X1
	M 12		1,5	100	13	9	7	10	4	★ -M12X1.5
	M 14		1,5	100	15	11	9	12	4	★ -M14X1.5

★ New addition to range



Machine tap Paradur® Eco Plus



$\leq 3 \times D_N$

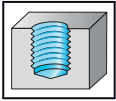

- HSS-E-PM
- Chamfer form C = 2 - 3 thread
- 45° helix angle
- Long-chipping materials from 500 to 1250 N/mm² or 38 HRC

MF

DIN 13

	P	M	K	N	S	H	O
THL	●●	●●	●●	●●			

DIN 374 6HX		D_N	P mm	l_1 js16 mm	L_c mm	d_1 h9 mm	\square h12 mm	l_g mm	N	THL Designation EP2156312
	M 8	1	90	12	6	4,9	8	3	★ -M8X1	
	M 10	1	90	12	7	5,5	8	3	★ -M10X1	
	M 10	1,25	100	15	7	5,5	8	3	★ -M10X1.25	
	M 12	1	100	13	9	7	10	4	★ -M12X1	
	M 12	1,25	100	13	9	7	10	4	★ -M12X1.25	
	M 12	1,5	100	13	9	7	10	4	★ -M12X1.5	
	M 14	1,5	100	15	11	9	12	4	★ -M14X1.5	
	M 16	1,5	100	15	12	9	12	4	★ -M16X1.5	
	M 18	1,5	110	17	14	11	14	4	★ -M18X1.5	
	M 20	1,5	125	17	16	12	15	4	★ -M20X1.5	

★ New addition to range

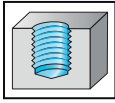

Machine tap Paradur® X-pert P

 $\leq 3 \times D_N$

- HSS-E
- Chamfer form C = 2 - 3 thread
- 45° helix angle
- Materials from 200 to 1000 N/mm² or 32 HRC
- For long-chipping materials

MF

DIN 13

	P	M	K	N	S	H	O
uncoated	●●	●	●	●	●	●	●
TiN	●●	●	●	●	●	●	●

DIN 371 ISO2/6H

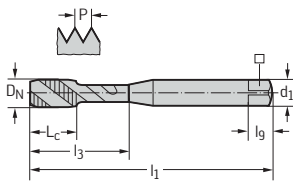

D _N	P mm	l ₁ js16 mm	L _c mm	l ₃ ±1 mm	d ₁ h9 mm	□ h12 mm	l _g mm	N	uncoated Designation P21519
M 2,5	0,35	50	4	12,5	2,8	2,1	5	3	★ -M2.5X0.35
M 3	0,25	56	6	18	3,5	2,7	6	3	★ -M3X0.25
M 3	0,35	56	6	18	3,5	2,7	6	3	★ -M3X0.35
M 4	0,35	63	7	21	4,5	3,4	6	3	★ -M4X0.35
M 4	0,5	63	7	21	4,5	3,4	6	3	★ -M4X0.5
M 4,5	0,5	70	8	25	6	4,9	8	3	★ -M4.5X0.5
M 5	0,5	70	8	25	6	4,9	8	3	★ -M5X0.5
M 6	0,5	80	10	30	6	4,9	8	3	★ -M6X0.5
M 6	0,75	80	10	30	6	4,9	8	3	★ -M6X0.75
M 7	0,75	80	10	30	7	5,5	8	3	★ -M7X0.75
M 8	1	90	12	35	8	6,2	9	3	★ -M8X1
M 10	1	90	12	39	10	8	11	3	★ -M10X1

DIN 374 ISO2/6H

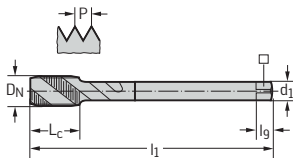

D _N	P mm	l ₁ js16 mm	L _c mm	l ₃ ±1 mm	d ₁ h9 mm	□ h12 mm	l _g mm	N	uncoated Designation P21569	TiN Designation P2156905
M 8	0,75	80	10	-	6	4,9	8	3	★ -M8X0.75	
M 8	1	90	12	-	6	4,9	8	3	★ -M8X1	★ -M8X1
M 9	1	90	13	-	7	5,5	8	3	★ -M9X1	
M 10	0,75	90	12	-	7	5,5	8	3	★ -M10X0.75	
M 10	1	90	12	-	7	5,5	8	3	★ -M10X1	★ -M10X1
M 10	1,25	100	15	-	7	5,5	8	3	★ -M10X1.25	★ -M10X1.25
M 12	1	100	13	-	9	7	10	4	★ -M12X1	★ -M12X1
M 12	1,25	100	13	-	9	7	10	4	★ -M12X1.25	★ -M12X1.25
M 12	1,5	100	13	-	9	7	10	4	★ -M12X1.5	★ -M12X1.5
M 14	1	100	15	-	11	9	12	4	★ -M14X1	
M 14	1,25	100	15	-	11	9	12	4	★ -M14X1.25	
M 14	1,5	100	15	-	11	9	12	4	★ -M14X1.5	★ -M14X1.5
M 16	1	100	15	-	12	9	12	4	★ -M16X1	
M 16	1,5	100	15	-	12	9	12	4	★ -M16X1.5	★ -M16X1.5
M 18	1	110	17	-	14	11	14	4	★ -M18X1	
M 18	1,5	110	17	-	14	11	14	4	★ -M18X1.5	★ -M18X1.5
M 20	1	125	17	-	16	12	15	4	★ -M20X1	
M 20	1,5	125	17	-	16	12	15	4	★ -M20X1.5	★ -M20X1.5
M 20	2	140	25	-	16	12	15	4	★ -M20X2	
M 22	1	125	18	-	18	14,5	17	4	★ -M22X1	
M 22	1,5	125	18	-	18	14,5	17	4	★ -M22X1.5	★ -M22X1.5
M 22	2	140	20	-	18	14,5	17	4	★ -M22X2	
M 24	1	140	20	-	18	14,5	17	5	★ -M24X1	
M 24	1,5	140	20	-	18	14,5	17	5	★ -M24X1.5	
M 24	2	140	20	-	18	14,5	17	5	★ -M24X2	
M 26	1,5	140	20	-	18	14,5	17	5	★ -M26X1.5	
M 27	1,5	140	20	-	20	16	19	5	★ -M27X1.5	
M 27	2	140	20	-	20	16	19	5	★ -M27X2	

Continued

★ New addition to range



Machine tap Paradur® X-pert P

 $\leq 3 \times D_N$

Continued

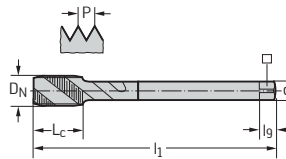
DIN 374 ISO2/6H		P mm	l_1 js16 mm	L_c mm	l_3 ± 1 mm	d_1 h9 mm	\square h12 mm	l_g mm	N	uncoated Designation P21569	TIN Designation P2156905
D_N											
	M 30	1,5	150	20	-	22	18	21	5	★ -M30X1.5	
	M 30	2	150	20	-	22	18	21	5	★ -M30X2	
	M 32	1,5	150	20	-	22	18	21	5	★ -M32X1.5	
	M 33	1,5	160	22	-	25	20	23	5	★ -M33X1.5	
	M 33	2	160	22	-	25	20	23	5	★ -M33X2	
	M 36	1,5	170	22	-	28	22	25	5	★ -M36X1.5	
	M 36	2	170	22	-	28	22	25	5	★ -M36X2	
	M 36	3	200	30	-	28	22	25	5	★ -M36X3	
	M 38	1,5	170	22	-	28	22	25	5	★ -M38X1.5	
	M 39	2	170	22	-	32	24	27	5	★ -M39X2	
	M 39	3	200	33	-	32	24	27	5	★ -M39X3	
	M 40	1,5	170	22	-	32	24	27	5	★ -M40X1.5	
	M 42	1,5	170	22	-	32	24	27	6	★ -M42X1.5	
	M 42	2	170	22	-	32	24	27	6	★ -M42X2	
	M 42	3	200	33	-	32	24	27	6	★ -M42X3	
	M 45	1,5	180	22	-	36	29	32	6	★ -M45X1.5	
	M 48	1,5	190	22	-	36	29	32	6	★ -M48X1.5	
	M 48	2	190	24	-	36	29	32	6	★ -M48X2	
	M 48	3	225	36	-	36	29	32	6	★ -M48X3	
	M 52	2	190	26	-	40	32	35	6	★ -M52X2	
M 52	3	225	36	-	40	32	35	6	★ -M52X3		

★ New addition to range

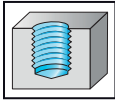

Machine tap Paradur® X-pert P

 $\leq 3 \times D_N$

- HSS-E
- Chamfer form C = 2 - 3 thread
- 45° helix angle
- Materials from 200 to 1000 N/mm² or 32 HRC
- For long-chipping materials

MF

DIN 13

	P	M	K	N	S	H	O
uncoated	●●			●			●
TiN	●●			●			●

DIN 374	ISO3/6G	D_N	P mm	l_1 js16 mm	L_c mm	d_1 h9 mm	\square h12 mm	l_g mm	N	uncoated Designation P21589	TiN Designation P2158905
		M 8	1	90	12	6	4,9	8	3	★ -M8X1	★ -M8X1
		M 10	1	90	12	7	5,5	8	3	★ -M10X1	★ -M10X1
		M 12	1	100	13	9	7	10	4	★ -M12X1	★ -M12X1
		M 12	1,5	100	13	9	7	10	4	★ -M12X1.5	★ -M12X1.5
		M 14	1,5	100	15	11	9	12	4	★ -M14X1.5	★ -M14X1.5
		M 16	1,5	100	15	12	9	12	4	★ -M16X1.5	★ -M16X1.5
		M 18	1,5	110	17	14	11	14	4	★ -M18X1.5	★ -M18X1.5
		M 20	1,5	125	17	16	12	15	4	★ -M20X1.5	★ -M20X1.5

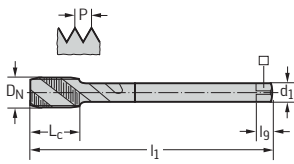

★ New addition to range

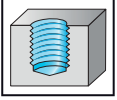

Machine tap Paradur® HT

 $\leq 3,5 \times D_N$

- HSS-E
- Chamfer form C = 2 - 3 thread
- Materials from 500 to 1400 N/mm² or 44 HRC
- For long- and short-chipping materials

MF

DIN 13

	P	M	K	N	S	H	O
TiN	●●	●	●●	●	●	●	●

DIN 374	ISO2/6H	D_N	P mm	l_1 js16 mm	L_c mm	d_1 h9 mm	\square h12 mm	l_g mm	N	TiN Designation 2136115
		M 8	1	90	18	6	4,9	8	3	★ -M8X1
		M 10	1	90	20	7	5,5	8	3	★ -M10X1
		M 12	1,5	100	21	9	7	10	3	-M12X1.5
		M 14	1,5	100	21	11	9	12	3	-M14X1.5
		M 16	1,5	100	21	12	9	12	3	-M16X1.5
		M 18	1,5	110	24	14	11	14	3	-M18X1.5
		M 20	1,5	125	24	16	12	15	3	-M20X1.5
		M 22	1,5	125	24	18	14,5	17	3	-M22X1.5
		M 24	1,5	140	26	18	14,5	17	4	-M24X1.5
		M 30	2	150	26	22	18	21	4	-M30X2
		M 33	2	160	28	25	20	23	4	-M33X2

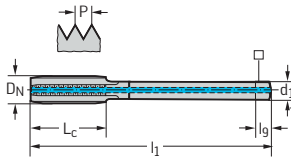

★ New addition to range



Machine tap Paradur® Short Chip HT



$\leq 3,5 \times D_N$

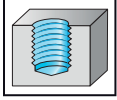

- HSS-E
- Chamfer form C = 2 - 3 thread
- 15° helix angle
- Reduced helix to 9° (uncoated)
- Materials from 800 to 1250 N/mm² or 38 HRC
- For long-chipping materials

MF

DIN 13

	P	M	K	N	S	H	O
THL	●●		●	●			

DIN 374 6HX	D_N	P mm	l_1 js16 mm	L_c mm	d_1 h9 mm	\square h12 mm	l_g mm	N	THL Designation 21460TR
	M 12X1,5	1,5	100	13	9	7	10	3	★ -M12X1.5
	M14X1.5	1,5	100	15	11	9	12	4	★ -M14X1.5
	M16X1.5	1,5	100	15	12	9	12	4	★ -M16X1.5

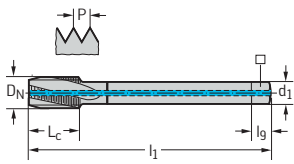

★ New addition to range



Machine tap Paradur® X-pert M



$\leq 2,5 \times D_N$

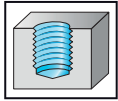

- HSS-E
- Chamfer form C = 2 - 3 thread
- 40° helix angle
- Higher positioned core
- Materials from 350 to 1200 N/mm² or 36 HRC
- For long-chipping materials

MF

DIN 13

	P	M	K	N	S	H	O
vap	●	●●	■	■	■	■	■
TiN	●	●●	■	■	■	■	■

DIN 371 6HX		D_N	P mm	l_1 js16 mm	L_c mm	l_3 ± 1 mm	d_1 h9 mm	\square h12 mm	l_g mm	N	VAP Designation M21513	TiN Designation M2151305
		M 4	0,5	63	7	21	4,5	3,4	6	3	★ -M4X0.5	★ -M4X0.5
		M 5	0,5	70	8	25	6	4,9	8	3	★ -M5X0.5	★ -M5X0.5
		M 6	0,5	80	10	30	6	4,9	8	3	★ -M6X0.5	★ -M6X0.5
		M 6	0,75	80	10	30	6	4,9	8	3	★ -M6X0.75	

DIN 374 6HX		D_N	P mm	l_1 js16 mm	L_c mm	l_3 ± 1 mm	d_1 h9 mm	\square h12 mm	l_g mm	N	VAP Designation M21563	TiN Designation M2156305
		M 8	0,5	80	10	-	6	4,9	8	3	★ -M8X0.5	★ -M8X0.5
		M 8	0,75	80	10	-	6	4,9	8	3	★ -M8X0.75	★ -M8X0.75
		M 8	1	90	12	-	6	4,9	8	3	★ -M8X1	★ -M8X1
		M 10	0,75	90	12	-	7	5,5	8	3	★ -M10X0.75	★ -M10X0.75
		M 10	1	90	12	-	7	5,5	8	3	★ -M10X1	★ -M10X1
		M 10	1,25	100	15	-	7	5,5	8	3	★ -M10X1.25	★ -M10X1.25
		M 12	1	100	13	-	9	7	10	4	★ -M12X1	★ -M12X1
		M 12	1,25	100	13	-	9	7	10	4	★ -M12X1.25	★ -M12X1.25
		M 12	1,5	100	13	-	9	7	10	4	★ -M12X1.5	★ -M12X1.5
		M 14	1	100	15	-	11	9	12	4	★ -M14X1	
		M 14	1,5	100	15	-	11	9	12	4	★ -M14X1.5	★ -M14X1.5
		M 16	1,5	100	15	-	12	9	12	4	★ -M16X1.5	★ -M16X1.5
		M 18	1,5	110	17	-	14	11	14	4	★ -M18X1.5	★ -M18X1.5
		M 20	1,5	125	17	-	16	12	15	4	★ -M20X1.5	★ -M20X1.5
		M 20	2	140	25	-	16	12	15	4	★ -M20X2	
		M 22	1,5	125	18	-	18	14,5	17	5	★ -M22X1.5	
		M 24	1,5	140	20	-	18	14,5	17	5	★ -M24X1.5	
		M 24	2	140	20	-	18	14,5	17	5	★ -M24X2	
		M 27	1,5	140	20	-	20	16	19	5	★ -M27X1.5	
		M 27	2	140	20	-	20	16	19	5	★ -M27X2	
		M 30	2	150	20	-	22	18	21	5	★ -M30X2	

★ New addition to range



Machine tap Paradur® X-pert M



$\leq 2,5 \times D_N$

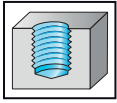

- HSS-E
- Chamfer form C = 2 - 3 thread
- 40° helix angle
- Higher positioned core
- Materials from 350 to 1200 N/mm² or 36 HRC
- For long-chipping materials

MF

DIN 13

	P	M	K	N	S	H	O
TiN	●	●●	●	●	●	●	●

DIN 374 6GX		D_N	P mm	l_1 js16 mm	L_c mm	d_1 h9 mm	\square h12 mm	l_g mm	N	TiN Designation M2158305
	M 8		1	90	12	6	4,9	8	3	★ -M8X1
	M 10		1	90	12	7	5,5	8	3	★ -M10X1
	M 12		1	100	13	9	7	10	4	★ -M12X1
	M 12		1,5	100	13	9	7	10	4	★ -M12X1.5
	M 14		1	100	15	11	9	12	4	★ -M14X1
	M 14		1,5	100	15	11	9	12	4	★ -M14X1.5
	M 16		1	100	15	12	9	12	4	★ -M16X1
	M 16		1,5	100	15	12	9	12	4	★ -M16X1.5

★ New addition to range



Machine tap Paradur® X-pert N



$\leq 3 \times D_N$

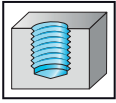

- HSS-E
- Chamfer form C = 2 - 3 thread
- 35° helix angle
- Materials from 200 to 700 N/mm² or 14 HRC
- For long-chipping materials

MF

DIN 13

	P	M	K	N	S	H	O
uncoated				●●	●		●

DIN 374	ISO2/6H	D_N	P mm	l_1 js16 mm	L_c mm	d_1 h9 mm	\square h12 mm	l_g mm	N	uncoated Designation N21566
		M 8	1	90	12	6	4,9	8	2	★ -M8X1
		M 10	1	90	12	7	5,5	8	3	★ -M10X1
		M 12	1	100	13	9	7	10	3	★ -M12X1
		M 12	1,5	100	13	9	7	10	3	★ -M12X1.5
		M 14	1,5	100	15	11	9	12	3	★ -M14X1.5
		M 16	1	100	15	12	9	12	4	★ -M16X1
		M 16	1,5	100	15	12	9	12	3	★ -M16X1.5
		M 18	1,5	110	17	14	11	14	4	★ -M18X1.5
		M 20	1,5	125	17	16	12	15	4	★ -M20X1.5

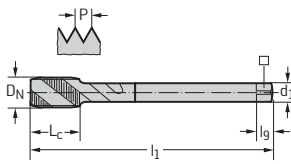

★ New addition to range



Machine tap Prototex® Eco Plus



$\leq 3,5 \times D_N$

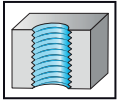

- HSS-E-PM
- Chamfer form B = 3.5 - 5 thread
- Materials from 500 to 1350 N/mm² or 42 HRC
- For long-chipping materials

UNC

ASME B1.1

	P	M	K	N	S	H	O
THL	●●	●●	●●	●●			

DIN 2184-1 2B	D _N -P Nom	D _N mm	l ₁ js16 mm	L _c mm	l ₃ ±1 mm	d ₁ h9 mm	□ h12 mm	l _g mm	N	THL Designation EP2221302
	Nr. 2-56	2,184	45	7	12	2,8	2,1	5	3	★ -UNC2
	Nr. 4-40	2,845	56	9	18	3,5	2,7	6	3	★ -UNC4
	Nr. 6-32	3,505	56	11	20	4	3	6	3	★ -UNC6
	Nr. 8-32	4,166	63	12	21	4,5	3,4	6	3	★ -UNC8
	Nr.10-24	4,826	70	13	25	6	4,9	8	3	★ -UNC10
	1/4-20	6,35	80	15	30	7	5,5	8	3	★ -UNC1/4

DIN 2184-1 2B	D _N -P Nom	D _N mm	l ₁ js16 mm	L _c mm	l ₃ ±1 mm	d ₁ h9 mm	□ h12 mm	l _g mm	N	THL Designation EP2226302
	5/16-18	7,938	90	18	-	6	4,9	8	3	★ -UNC5/16
	3/8-16	9,525	100	20	-	7	5,5	8	3	★ -UNC3/8
	1/2-13	12,7	110	23	-	9	7	10	4	★ -UNC1/2
	5/8-11	15,875	110	25	-	12	9	12	4	★ -UNC5/8

★ New addition to range



Machine tap Prototex® X-pert P



$\leq 3 \times D_N$

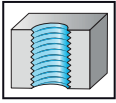

- HSS-E
- Chamfer form B = 3.5 - 5 thread
- Materials from 200 to 1000 N/mm² or 32 HRC
- For long-chipping materials

UNC

ASME B1.1

	P	M	K	N	S	H	O
uncoated	●	●	●	●	●	●	●

DIN 2184-1 2B	D _N -P Nom	D _N mm	l ₁ js16 mm	L _c mm	l ₃ ±1 mm	d ₁ h9 mm	□ h12 mm	l _g mm	N	uncoated Designation P22210
	Nr. 2-56	2,184	45	7	12	2,8	2,1	5	2	★ -UNC2
	Nr. 4-40	2,845	56	9	18	3,5	2,7	6	2	★ -UNC4
	Nr. 6-32	3,505	56	11	20	4	3	6	2	★ -UNC6
	Nr. 8-32	4,166	63	12	21	4,5	3,4	6	2	★ -UNC8

★ New addition to range



Machine tap Prototex® X-pert P



$\leq 3 \times D_N$

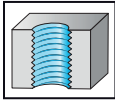

- HSS-E
- Chamfer form B = 3.5 - 5 thread
- Materials from 200 to 1000 N/mm² or 32 HRC
- For long-chipping materials

UNC

ASME B1.1

	P	M	K	N	S	H	O
uncoated	●●			●			●

DIN 2184-1 3B	D _N -P Nom	D _N mm	l ₁ js16 mm	l ₃ ±1 mm	d ₁ h9 mm	□ h12 mm	l _g mm	N	uncoated Designation P22200
	Nr. 2-56	2,184	45	12	2,8	2,1	5	2	★ -UNC2
	Nr. 4-40	2,845	56	18	3,5	2,7	6	2	★ -UNC4
	Nr. 6-32	3,505	56	20	4	3	6	2	★ -UNC6
	Nr. 8-32	4,166	63	21	4,5	3,4	6	2	★ -UNC8

★ New addition to range



Machine tap Prototex® X-pert P



$\leq 3 \times D_N$

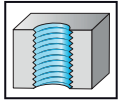

- HSS-E
- Chamfer form B = 3.5 - 5 thread
- Materials from 200 to 1000 N/mm² or 32 HRC
- For long-chipping materials

UNC

ASME B1.1

	P	M	K	N	S	H	O
uncoated	●●			●			●
TiN	●●			●			●

DIN 2184-1 2B	D _N -P Nom	D _N mm	l ₁ js16 mm	L _c mm	l ₃ ±1 mm	d ₁ h9 mm	□ h12 mm	l _g mm	N	uncoated Designation P22310	TiN Designation P2231005
	Nr. 2-56	2,184	45	7	12	2,8	2,1	5	3	★ -UNC2	
	Nr. 4-40	2,845	56	9	18	3,5	2,7	6	3	★ -UNC4	
	Nr. 5-40	3,175	56	10	18	3,5	2,7	6	3	★ -UNC5	
	Nr. 6-32	3,505	56	11	20	4	3	6	3	★ -UNC6	★ -UNC6
	Nr. 8-32	4,166	63	12	21	4,5	3,4	6	3	★ -UNC8	
	Nr.10-24	4,826	70	13	25	6	4,9	8	3	★ -UNC10	
	Nr.12-24	5,486	80	15	30	6	4,9	8	3	★ -UNC12	
	1/4-20	6,35	80	15	30	7	5,5	8	3	★ -UNC1/4	
	5/16-18	7,938	90	18	35	8	6,2	9	3	★ -UNC5/16	
	3/8-16	9,525	100	20	39	10	8	11	3	★ -UNC3/8	

DIN 2184-1 2B	D _N -P Nom	D _N mm	l ₁ js16 mm	L _c mm	l ₃ ±1 mm	d ₁ h9 mm	□ h12 mm	l _g mm	N	uncoated Designation P22360	TiN Designation P2236005
	7/16-14	11,113	100	20	-	8	6,2	9	3	★ -UNC7/16	
	1/2-13	12,7	110	23	-	9	7	10	3	★ -UNC1/2	★ -UNC1/2
	9/16-12	14,288	110	25	-	11	9	12	3	★ -UNC9/16	
	5/8-11	15,875	110	25	-	12	9	12	3	★ -UNC5/8	★ -UNC5/8
	3/4-10	19,05	125	30	-	14	11	14	3	★ -UNC3/4	★ -UNC3/4
	7/8-9	22,225	140	30	-	18	14,5	17	3	★ -UNC7/8	
	1-8	25,4	160	36	-	18	14,5	17	3	★ -UNC1	
	1 1/8-7	28,575	180	42	-	22	18	21	4	★ -UNC1.1/8	
	1 1/4-7	31,75	180	42	-	22	18	21	4	★ -UNC1.1/4	
	1 1/2-6	38,1	200	48	-	28	22	25	4	★ -UNC1.1/2	

★ New addition to range



Machine tap Prototex® X-pert M



$\leq 3 \times D_N$

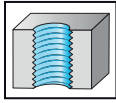

- HSS-E
- Chamfer form B = 3.5 - 5 thread
- Materials from 350 to 1200 N/mm² or 36 HRC
- For long-chipping materials

UNC

ASME B1.1

	P	M	K	N	S	H	O
vap	●	●●	■	■	■	■	■
TiN	●	●●	■	■	■	■	■

DIN 2184-1 2B

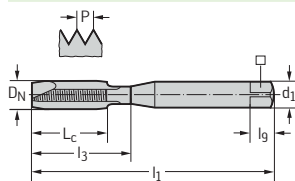

D _N -P Nom	D _N mm	l ₁ js16 mm	L _c mm	l ₃ ±1 mm	d ₁ h9 mm	□ h12 mm	l _g mm	N	VAP Designation M22213	TIN Designation M2221305
Nr. 2-56	2,184	45	7	12	2,8	2,1	5	2	★ -UNC2	★ -UNC2
Nr. 3-48	2,515	50	8	12,5	2,8	2,1	5	2	★ -UNC3	★ -UNC3
Nr. 4-40	2,845	56	9	18	3,5	2,7	6	2	★ -UNC4	★ -UNC4
Nr. 5-40	3,175	56	10	18	3,5	2,7	6	2	★ -UNC5	★ -UNC5
Nr. 6-32	3,505	56	11	20	4	3	6	2	★ -UNC6	★ -UNC6
Nr. 8-32	4,166	63	12	21	4,5	3,4	6	3	★ -UNC8	★ -UNC8
Nr.10-24	4,826	70	13	25	6	4,9	8	3	★ -UNC10	★ -UNC10
Nr.12-24	5,486	80	15	30	6	4,9	8	3	★ -UNC12	★ -UNC12
1/4-20	6,35	80	15	30	7	5,5	8	3	★ -UNC1/4	★ -UNC1/4

DIN 2184-1 2B

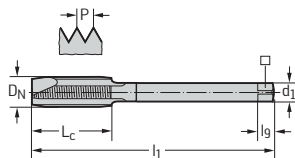

D _N -P Nom	D _N mm	l ₁ js16 mm	L _c mm	l ₃ ±1 mm	d ₁ h9 mm	□ h12 mm	l _g mm	N	VAP Designation M22263	TIN Designation M2226305
5/16-18	7,938	90	18	-	6	4,9	8	3	★ -UNC5/16	
3/8-16	9,525	100	20	-	7	5,5	8	3	★ -UNC3/8	★ -UNC3/8
7/16-14	11,113	100	20	-	8	6,2	9	3	★ -UNC7/16	
1/2-13	12,7	110	23	-	9	7	10	4	★ -UNC1/2	★ -UNC1/2
9/16-12	14,288	110	25	-	11	9	12	4	★ -UNC9/16	
5/8-11	15,875	110	25	-	12	9	12	4	★ -UNC5/8	
3/4-10	19,05	125	30	-	14	11	14	4	★ -UNC3/4	
7/8-9	22,225	140	30	-	18	14,5	17	4	★ -UNC7/8	
1-8	25,4	160	36	-	18	14,5	17	4	★ -UNC1	

★ New addition to range



Machine tap Paradur® Eco Plus



$\leq 3 \times D_N$

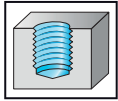

- HSS-E-PM
- Chamfer form C = 2 - 3 thread
- 45° helix angle
- Long-chipping materials from 500 to 1250 N/mm² or 38 HRC
- For long-chipping materials

UNC

ASME B1.1

	P	M	K	N	S	H	O
THL	●●	●●	●●	●●			

~DIN 2184-1 2B	D _N -P Nom	D _N mm	l ₁ js16 mm	L _c mm	l ₃ ±1 mm	d ₁ h9 mm	□ h12 mm	l _g mm	N	THL Designation EP2251302
	Nr. 2-56	2,184	45	4	8,4	2,8	2,1	5	3	★ -UNC2 ⁴
	Nr. 4-40	2,845	56	6	11	3,5	2,7	6	3	★ -UNC4
	Nr. 6-32	3,505	56	6,5	13,7	4	3	6	3	★ -UNC6
	Nr. 8-32	4,166	63	7	17,8	4,5	3,4	6	3	★ -UNC8
	Nr.10-24	4,826	70	8	20,7	6	4,9	8	3	★ -UNC10
	1/4-20	6,35	80	10	27,3	7	5,5	8	3	★ -UNC1/4

⁴ without thread taper

DIN 2184-1 2B	D _N -P Nom	D _N mm	l ₁ js16 mm	L _c mm	l ₃ ±1 mm	d ₁ h9 mm	□ h12 mm	l _g mm	N	THL Designation EP2256302
	5/16-18	7,938	90	12	-	6	4,9	8	3	★ -UNC5/16
	3/8-16	9,525	100	15	-	7	5,5	8	3	★ -UNC3/8
	1/2-13	12,7	110	18	-	9	7	10	4	★ -UNC1/2
	5/8-11	15,875	110	20	-	12	9	12	4	★ -UNC5/8

★ New addition to range



Machine tap Paradur® Eco Plus



$\leq 3 \times D_N$

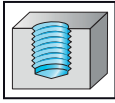

- HSS-E-PM
- Chamfer form C = 2 - 3 thread
- 45° helix angle
- Long-chipping materials from 500 to 1250 N/mm² or 38 HRC
- For long-chipping materials

UNC

ASME B1.1

	P	M	K	N	S	H	O
THL	●●	●●	●●	●●			

~DIN 2184-1 2B	D _N -P Nom	D _N mm	l ₁ js16 mm	L _c mm	l ₃ ±1 mm	d ₁ h9 mm	□ h12 mm	l _g mm	N	THL Designation EP2251312
	1/4-20	6,35	80	10	27,3	7	5,5	8	3	★ -UNC1/4

DIN 2184-1 2B	D _N -P Nom	D _N mm	l ₁ js16 mm	L _c mm	l ₃ ±1 mm	d ₁ h9 mm	□ h12 mm	l _g mm	N	THL Designation EP2256312
	5/16-18	7,938	90	12	-	6	4,9	8	3	★ -UNC5/16
	3/8-16	9,525	100	15	-	7	5,5	8	3	★ -UNC3/8
	1/2-13	12,7	110	18	-	9	7	10	4	★ -UNC1/2
	5/8-11	15,875	110	20	-	12	9	12	4	★ -UNC5/8
	3/4-10	19,05	125	25	-	14	11	14	4	★ -UNC3/4

★ New addition to range



Machine tap Paradur® Eco Plus



$$\leq 3 \times D_N$$

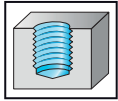

- HSS-E-PM
- Chamfer form C = 2 - 3 thread
- 45° helix angle
- Long-chipping materials from 500 to 1250 N/mm² or 38 HRC

UNC

ASME B1.1

	P	M	K	N	S	H	O
THL	●●	●●	●●	●●			

DIN/ANSI 2B	D _N -TPI Nom	D _N inch	l ₁ inch	L _c js16 inch	l ₃ inch	d ₁ h9 inch	□ h12 inch	l _g inch	N	THL Designation AEP2251302
	No. 4-40	0.112	2.205	0.236	0.437	0.141	0.110	3/16	3	★ -UNC4
	No. 6-32	0.138	2.205	0.256	0.539	0.141	0.110	3/16	3	★ -UNC6
	No. 8-32	0.164	2.480	0.276	0.701	0.168	0.131	1/4	3	★ -UNC8
	No.10-24	0.190	2.756	0.315	0.831	0.194	0.152	1/4	3	★ -UNC10
	1/4-20	0.250	3.150	0.394	1.075	0.255	0.191	5/16	3	★ -UNC1/4
	5/16-18	0.313	3.543	0.472	1.378	0.318	0.238	3/8	3	★ -UNC5/16
	3/8-16	0.375	3.937	0.591	1.535	0.381	0.286	7/16	3	★ -UNC3/8

DIN/ANSI 2B	D _N -TPI Nom	D _N inch	l ₁ inch	L _c js16 inch	l ₃ inch	d ₁ h9 inch	□ h12 inch	l _g inch	N	THL Designation AEP2256302
	1/2-13	0.500	4.331	0.709	-	0.367	0.275	7/16	4	★ -UNC1/2
	5/8-11	0.625	4.331	0.787	-	0.480	0.360	9/16	4	★ -UNC5/8
	3/4-10	0.750	4.921	0.984	-	0.590	0.442	11/16	4	★ -UNC3/4

★ New addition to range



Machine tap Paradur® Eco Plus



$\leq 3 \times D_N$

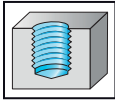

- HSS-E-PM
- Chamfer form C = 2 - 3 thread
- 45° helix angle
- Long-chipping materials from 500 to 1250 N/mm² or 38 HRC

UNC

ASME B1.1

	P	M	K	N	S	H	O
THL	●●	●●	●●	●●			

DIN/ANSI 2B	D _N -TPI Nom	D _N inch	l ₁ inch	L _c js16 inch	l ₃ inch	d ₁ h9 inch	□ h12 inch	l _g inch	N	THL Designation AEP2251312
	1/4-20	0.250	3.150	0.394	1.075	0.255	0.191	5/16	3	★ -UNC1/4
	5/16-18	0.313	3.543	0.472	1.378	0.318	0.238	3/8	3	★ -UNC5/16
	3/8-16	0.375	3.937	0.591	1.535	0.381	0.286	7/16	3	★ -UNC3/8

DIN/ANSI 2B	D _N -TPI Nom	D _N inch	l ₁ inch	L _c js16 inch	l ₃ inch	d ₁ h9 inch	□ h12 inch	l _g inch	N	THL Designation AEP2256312
	1/2-13	0.500	4.331	0.709	-	0.367	0.275	7/16	4	★ -UNC1/2
	5/8-11	0.625	4.331	0.787	-	0.480	0.360	9/16	4	★ -UNC5/8
	3/4-10	0.750	4.921	0.984	-	0.590	0.442	11/16	4	★ -UNC3/4

★ New addition to range



Machine tap Paradur® X-pert P

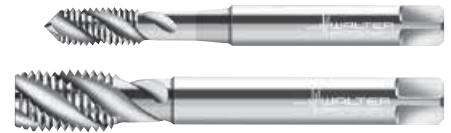

$\leq 3 \times D_N$

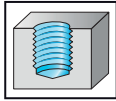

- HSS-E
- Chamfer form C = 2 - 3 thread
- 45° helix angle
- Materials from 200 to 1000 N/mm² or 32 HRC
- For long-chipping materials

UNC

ASME B1.1

	P	M	K	N	S	H	O
uncoated	●●			●			●

DIN 2184-1 2B	D _N -P Nom	D _N mm	l ₁ js16 mm	L _c mm	l ₃ ±1 mm	d ₁ h9 mm	□ h12 mm	l _g mm	N	uncoated Designation P22519
	Nr. 2-56	2,184	45	4	12	2,8	2,1	5	3	★ -UNC2
	Nr. 3-48	2,515	50	4	12,5	2,8	2,1	5	3	★ -UNC3
	Nr. 4-40	2,845	56	6	18	3,5	2,7	6	3	★ -UNC4
	Nr. 5-40	3,175	56	6	18	3,5	2,7	6	3	★ -UNC5
	Nr. 6-32	3,505	56	6,5	20	4	3	6	3	★ -UNC6
	Nr. 8-32	4,166	63	7	21	4,5	3,4	6	3	★ -UNC8
	Nr.10-24	4,826	70	8	25	6	4,9	8	3	★ -UNC10
	Nr.12-24	5,486	80	10	30	6	4,9	8	3	★ -UNC12
	1/4-20	6,35	80	10	30	7	5,5	8	3	★ -UNC1/4
	5/16-18	7,938	90	12	35	8	6,2	9	3	★ -UNC5/16
	3/8-16	9,525	100	15	39	10	8	11	3	★ -UNC3/8

DIN 2184-1 2B	D _N -P Nom	D _N mm	l ₁ js16 mm	L _c mm	l ₃ ±1 mm	d ₁ h9 mm	□ h12 mm	l _g mm	N	uncoated Designation P22569
	7/16-14	11,113	100	15	-	8	6,2	9	3	★ -UNC7/16
	1/2-13	12,7	110	18	-	9	7	10	4	★ -UNC1/2
	9/16-12	14,288	110	20	-	11	9	12	4	★ -UNC9/16
	5/8-11	15,875	110	20	-	12	9	12	4	★ -UNC5/8
	3/4-10	19,05	125	25	-	14	11	14	4	★ -UNC3/4
	7/8-9	22,225	140	25	-	18	14,5	17	4	★ -UNC7/8
	1-8	25,4	160	30	-	18	14,5	17	4	★ -UNC1
	1 1/8-7	28,575	180	35	-	22	18	21	4	★ -UNC1.1/8
	1 1/4-7	31,75	180	35	-	22	18	21	4	★ -UNC1.1/4
	1 1/2-6	38,1	200	40	-	28	22	25	4	★ -UNC1.1/2

★ New addition to range

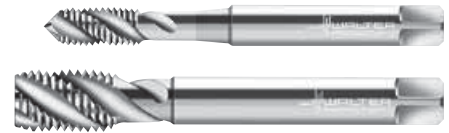
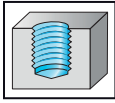

Machine tap Paradur® X-pert P

 $\leq 3 \times D_N$

- HSS-E
- Chamfer form C = 2 - 3 thread
- 45° helix angle
- Materials from 200 to 1000 N/mm² or 32 HRC
- For long-chipping materials

UNC

ASME B1.1

	P	M	K	N	S	H	O
uncoated	●	●	●	●	●	●	●

DIN 2184-1 3B	D _N -P Nom	D _N mm	l ₁ js16 mm	L _c mm	l ₃ ±1 mm	d ₁ h9 mm	□ h12 mm	l _g mm	N	uncoated
										Designation P22509
	Nr. 2-56	2,184	45	4	12	2,8	2,1	5	3	★ -UNC2
	Nr. 3-48	2,515	50	4	12,5	2,8	2,1	5	3	★ -UNC3
	Nr. 4-40	2,845	56	6	18	3,5	2,7	6	3	★ -UNC4
	Nr. 6-32	3,505	56	6,5	20	4	3	6	3	★ -UNC6
	Nr. 8-32	4,166	63	7	21	4,5	3,4	6	3	★ -UNC8
	Nr.10-24	4,826	70	8	25	6	4,9	8	3	★ -UNC10
	1/4-20	6,35	80	10	30	7	5,5	8	3	★ -UNC1/4
	5/16-18	7,938	90	12	35	8	6,2	9	3	★ -UNC5/16
	3/8-16	9,525	100	15	39	10	8	11	3	★ -UNC3/8

DIN 2184-1 3B	D _N -P Nom	D _N mm	l ₁ js16 mm	L _c mm	l ₃ ±1 mm	d ₁ h9 mm	□ h12 mm	l _g mm	N	uncoated
										Designation P22509
	5/16-18	7,938	90	12	-	6	4,9	8	3	★ -UNC5/16
	3/8-16	9,525	100	15	-	7	5,5	8	3	★ -UNC3/8
	7/16-14	11,113	100	15	-	8	6,2	9	3	★ -UNC7/16
	1/2-13	12,7	110	18	-	9	7	10	4	★ -UNC1/2
	9/16-12	14,288	110	20	-	11	9	12	4	★ -UNC9/16
	5/8-11	15,875	110	20	-	12	9	12	4	★ -UNC5/8
	3/4-10	19,05	125	25	-	14	11	14	4	★ -UNC3/4
	7/8-9	22,225	140	25	-	18	14,5	17	4	★ -UNC7/8
	1-8	25,4	160	30	-	18	14,5	17	4	★ -UNC1
	1 1/4-7	31,75	180	35	-	22	18	21	4	★ -UNC1.1/4

★ New addition to range



Machine tap Paradur® X-pert M



$\leq 2,5 \times D_N$

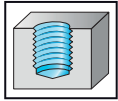

- HSS-E
- Chamfer form C = 2 - 3 thread
- 40° helix angle
- Materials from 350 to 1200 N/mm² or 36 HRC
- For long-chipping materials

UNC

ASME B1.1

	P	M	K	N	S	H	O
vap	●	●●	■	■	■	■	■
TiN	●	●●	■	■	■	■	■

DIN 2184-1 2B	D _N -P Nom	D _N mm	l ₁ js16 mm	L _c mm	l ₃ ±1 mm	d ₁ h9 mm	□ h12 mm	l _g mm	N	VAP Designation M22513	TiN Designation M2251305
	Nr. 2-56	2,184	45	4	12	2,8	2,1	5	3	★ -UNC2 ⁴	★ -UNC2 ⁴
	Nr. 3-48	2,515	50	4	12,5	2,8	2,1	5	3	★ -UNC3	★ -UNC3
	Nr. 4-40	2,845	56	6	18	3,5	2,7	6	3	★ -UNC4	★ -UNC4
	Nr. 5-40	3,175	56	6	18	3,5	2,7	6	3	★ -UNC5	★ -UNC5
	Nr. 6-32	3,505	56	6,5	20	4	3	6	3	★ -UNC6	★ -UNC6
	Nr. 8-32	4,166	63	7	21	4,5	3,4	6	3	★ -UNC8	★ -UNC8
	Nr.10-24	4,826	70	8	25	6	4,9	8	3	★ -UNC10	★ -UNC10
	Nr.12-24	5,486	80	10	30	6	4,9	8	3	★ -UNC12	★ -UNC12
	1/4-20	6,35	80	10	30	7	5,5	8	3	★ -UNC1/4	★ -UNC1/4

⁴ without thread taper

DIN 2184-1 2B	D _N -P Nom	D _N mm	l ₁ js16 mm	L _c mm	l ₃ ±1 mm	d ₁ h9 mm	□ h12 mm	l _g mm	N	VAP Designation M22563	TiN Designation M2256305
	5/16-18	7,938	90	12	-	6	4,9	8	3	★ -UNC5/16	★ -UNC5/16
	3/8-16	9,525	100	15	-	7	5,5	8	3	★ -UNC3/8	★ -UNC3/8
	7/16-14	11,113	100	15	-	8	6,2	9	3	★ -UNC7/16	★ -UNC7/16
	1/2-13	12,7	110	18	-	9	7	10	4	★ -UNC1/2	★ -UNC1/2
	9/16-12	14,288	110	20	-	11	9	12	4	★ -UNC9/16	★ -UNC9/16
	5/8-11	15,875	110	20	-	12	9	12	4	★ -UNC5/8	★ -UNC5/8
	3/4-10	19,05	125	25	-	14	11	14	4	★ -UNC3/4	★ -UNC3/4
	7/8-9	22,225	140	25	-	18	14,5	17	4	★ -UNC7/8	★ -UNC7/8
	1-8	25,4	160	30	-	18	14,5	17	4	★ -UNC1	★ -UNC1
	1 1/8-7	28,575	180	35	-	22	18	21	5	★ -UNC1.1/8	
	1 1/4-7	31,75	180	35	-	22	18	21	5	★ -UNC1.1/4	
	1 1/2-6	38,1	200	40	-	28	22	25	5	★ -UNC1.1/2	

★ New addition to range

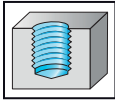

Machine tap Paradur® X-pert N

 $\leq 3 \times D_N$

- HSS-E
- Chamfer form C = 2 - 3 thread
- 35° helix angle
- Materials from 200 to 700 N/mm² or 14 HRC
- For long-chipping materials

UNC

ASME B1.1

	P	M	K	N	S	H	O
uncoated				●●	●		●

DIN 2184-1 2B	D _N -P Nom	D _N mm	l ₁ js16 mm	L _c mm	l ₃ ±1 mm	d ₁ h9 mm	□ h12 mm	l _g mm	N	uncoated Designation N22516
	Nr. 2-56	2,184	45	4	12	2,8	2,1	5	2	★ -UNC2
	Nr. 4-40	2,845	56	6	18	3,5	2,7	6	2	★ -UNC4
	Nr. 6-32	3,505	56	6,5	20	4	3	6	2	★ -UNC6
	Nr. 8-32	4,166	63	7	21	4,5	3,4	6	2	★ -UNC8
	Nr.10-24	4,826	70	8	25	6	4,9	8	2	★ -UNC10
	1/4-20	6,35	80	10	30	7	5,5	8	2	★ -UNC1/4
	5/16-18	7,938	90	12	35	8	6,2	9	2	★ -UNC5/16
	3/8-16	9,525	100	15	39	10	8	11	2	★ -UNC3/8

★ New addition to range



Machine tap Prototex® Eco Plus



≤3,5xD_N

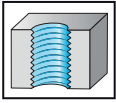

- HSS-E-PM
- Chamfer form B = 3.5 - 5 thread
- Materials from 500 to 1350 N/mm² or 42 HRC
- For long-chipping materials

UNF

ASME B1.1

	P	M	K	N	S	H	O
THL	●●	●●	●●	●●			

DIN 2184-1 2B	D _N -P Nom	D _N mm	l ₁ js16 mm	L _c mm	l ₃ ±1 mm	d ₁ h9 mm	□ h12 mm	l _g mm	N	THL Designation EP2321302
	Nr. 4-48	2,845	56	9	18	3,5	2,7	6	3	★ -UNF4
	Nr. 6-40	3,505	56	11	20	4	3	6	3	★ -UNF6
	Nr. 8-36	4,166	63	12	21	4,5	3,4	6	3	★ -UNF8
	Nr.10-32	4,826	70	13	25	6	4,9	8	3	★ -UNF10
	1/4-28	6,35	80	15	30	7	5,5	8	3	★ -UNF1/4

DIN 2184-1 2B	D _N -P Nom	D _N mm	l ₁ js16 mm	L _c mm	l ₃ ±1 mm	d ₁ h9 mm	□ h12 mm	l _g mm	N	THL Designation EP2326302
	5/16-24	7,938	90	18	-	6	4,9	8	3	★ -UNF5/16
	3/8-24	9,525	100	20	-	7	5,5	8	3	★ -UNF3/8
	1/2-20	12,7	100	21	-	9	7	10	4	★ -UNF1/2
	5/8-18	15,875	100	21	-	12	9	12	4	★ -UNF5/8

★ New addition to range



Machine tap Prototex® X-pert P



$\leq 3 \times D_N$

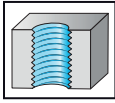

- HSS-E
- Chamfer form B = 3.5 - 5 thread
- Materials from 200 to 1000 N/mm² or 32 HRC
- For long-chipping materials

UNF

ASME B1.1

	P	M	K	N	S	H	O
uncoated	●●	●	●	●	●	●	●
TiN	●●	●	●	●	●	●	●

DIN 2184-1 2B	D _N -P Nom	D _N mm	l ₁ js16 mm	L _c mm	l ₃ ±1 mm	d ₁ h9 mm	□ h12 mm	l _g mm	N	uncoated Designation P23210	TiN Designation P2321005
	Nr. 0-80	1,524	40	8	-	2,5	2,1	5	2	★ -UNF0 ¹	
	Nr. 1-72	1,854	45	6	9	2,8	2,1	5	2	★ -UNF1	
	Nr. 2-64	2,184	45	7	12	2,8	2,1	5	2	★ -UNF2	
	Nr. 3-56	2,515	50	8	12,5	2,8	2,1	5	2	★ -UNF3	
	Nr. 4-48	2,845	56	9	18	3,5	2,7	6	2	★ -UNF4	
	Nr. 6-40	3,505	56	11	20	4	3	6	2	★ -UNF6	
	Nr. 8-36	4,166	63	12	21	4,5	3,4	6	2	★ -UNF8	
	Nr.10-32	4,826	70	13	25	6	4,9	8	2	★ -UNF10	
	Nr.12-28	5,486	80	15	30	6	4,9	8	3	★ -UNF12	★ -UNF12
	1/4-28	6,35	80	15	30	7	5,5	8	3	★ -UNF1/4	★ -UNF1/4

¹ without reduced neck after the thread

★ New addition to range



Machine tap Prototex® X-pert P



$\leq 3 \times D_N$

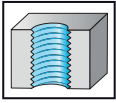

- HSS-E
- Chamfer form B = 3.5 - 5 thread
- Materials from 200 to 1000 N/mm² or 32 HRC
- For long-chipping materials

UNF

ASME B1.1

	P	M	K	N	S	H	O
uncoated	●●			●			●

DIN 2184-1 3B	D _N -P Nom	D _N mm	l ₁ js16 mm	l ₃ ±1 mm	d ₁ h9 mm	□ h12 mm	l _g mm	N	uncoated Designation P23200
	Nr. 2-64	2,184	45	12	2,8	2,1	5	2	★ -UNF2
	Nr. 4-48	2,845	56	18	3,5	2,7	6	2	★ -UNF4
	Nr. 6-40	3,505	56	20	4	3	6	2	★ -UNF6
	Nr. 8-36	4,166	63	21	4,5	3,4	6	2	★ -UNF8
	Nr. 10-32	4,826	70	25	6	4,9	8	2	★ -UNF10
	Nr. 12-28	5,486	80	30	6	4,9	8	3	★ -UNF12
	1/4-28	6,35	80	30	7	5,5	8	3	★ -UNF1/4

★ New addition to range

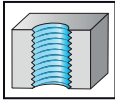

Machine tap Prototex® X-pert P

 $\leq 3 \times D_N$

- HSS-E
- Chamfer form B = 3.5 - 5 thread
- Materials from 200 to 1000 N/mm² or 32 HRC
- For long-chipping materials

UNF

ASME B1.1

	P	M	K	N	S	H	O
uncoated	●●			●			●
TiN	●●			●			●

DIN 2184-1 2B	D _N -P Nom	D _N mm	l ₁ js16 mm	L _c mm	d ₁ h9 mm	□ h12 mm	l _g mm	N	uncoated	TiN
									Designation P23360	Designation P2336005
	5/16-24	7,938	90	18	6	4,9	8	3	★ -UNF5/16	★ -UNF5/16
	3/8-24	9,525	100	20	7	5,5	8	3	★ -UNF3/8	★ -UNF3/8
	7/16-20	11,113	100	20	8	6,2	9	3	★ -UNF7/16	★ -UNF7/16
	1/2-20	12,7	100	21	9	7	10	4	★ -UNF1/2	★ -UNF1/2
	9/16-18	14,288	100	21	11	9	12	4	★ -UNF9/16	
	5/8-18	15,875	100	21	12	9	12	4	★ -UNF5/8	★ -UNF5/8
	3/4-16	19,05	110	24	14	11	14	4	★ -UNF3/4	★ -UNF3/4
	7/8-14	22,225	125	24	18	14,5	17	4	★ -UNF7/8	
	1-12	25,4	140	26	18	14,5	17	4	★ -UNF1	
	1 1/8-12	28,575	150	26	22	18	21	4	★ -UNF1.1/8	
	1 1/4-12	31,75	150	26	22	18	21	4	★ -UNF1.1/4	
	1 3/8-12	34,925	170	28	28	22	25	4	★ -UNF1.3/8	
	1 1/2-12	38,1	170	28	28	22	25	4	★ -UNF1.1/2	

★ New addition to range



Machine tap Prototex® X-pert M



$\leq 3 \times D_N$

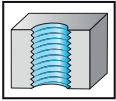

- HSS-E
- Chamfer form B = 3.5 - 5 thread
- Materials from 350 to 1200 N/mm² or 36 HRC
- For long-chipping materials

UNF

ASME B1.1

	P	M	K	N	S	H	O
vap	●	●●	■	■	■	■	■
TiN	●	●●	■	■	■	■	■

DIN 2184-1 2B		D _N -P Nom	D _N mm	l ₁ js16 mm	L _c mm	l ₃ ±1 mm	d ₁ h9 mm	□ h12 mm	l _g mm	N	VAP Designation M23213	TIN Designation M2321305
	Nr. 5-44	3,175	56	10	18	3,5	2,7	6	2	★ -UNF5		
	Nr. 6-40	3,505	56	11	20	4	3	6	2	★ -UNF6		
	Nr. 8-36	4,166	63	12	21	4,5	3,4	6	2	★ -UNF8		
	Nr.10-32	4,826	70	13	25	6	4,9	8	3	★ -UNF10	★ -UNF10	
	Nr.12-28	5,486	80	15	30	6	4,9	8	3	★ -UNF12		
	1/4-28	6,35	80	15	30	7	5,5	8	3	★ -UNF1/4	★ -UNF1/4	

DIN 2184-1 2B		D _N -P Nom	D _N mm	l ₁ js16 mm	L _c mm	l ₃ ±1 mm	d ₁ h9 mm	□ h12 mm	l _g mm	N	VAP Designation M23263	TIN Designation M2326305
	5/16-24	7,938	90	18	-	6	4,9	8	3	★ -UNF5/16	★ -UNF5/16	
	3/8-24	9,525	100	20	-	7	5,5	8	3	★ -UNF3/8	★ -UNF3/8	
	7/16-20	11,113	100	20	-	8	6,2	9	3	★ -UNF7/16	★ -UNF7/16	
	1/2-20	12,7	100	21	-	9	7	10	4	★ -UNF1/2	★ -UNF1/2	
	9/16-18	14,288	100	21	-	11	9	12	4	★ -UNF9/16		
	5/8-18	15,875	100	21	-	12	9	12	4	★ -UNF5/8		
	3/4-16	19,05	110	24	-	14	11	14	4	★ -UNF3/4		
	7/8-14	22,225	125	24	-	18	14,5	17	4	★ -UNF7/8		
1-12	25,4	140	26	-	18	14,5	17	4	★ -UNF1			

★ New addition to range

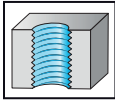

Machine tap Prototex® X-pert P

 $\leq 3 \times D_N$

- HSS-E
- Chamfer form B = 3.5 - 5 thread
- Materials from 200 to 1000 N/mm² or 32 HRC
- For long-chipping materials

UNEF

ASME B1.1

	P	M	K	N	S	H	O
uncoated	●●			●			●

DIN 2184-1 2B	D _N -P Nom	D _N mm	l ₁ js16 mm	L _c mm	d ₁ h9 mm	□ h12 mm	l _g mm	N	uncoated Designation P233602
	1/4-32	6,35	80	15	4,5	3,4	6	3	★ -UNEF1/4
	5/16-32	7,938	90	18	6	4,9	8	3	★ -UNEF5/16
	3/8-32	9,525	90	20	7	5,5	8	3	★ -UNEF3/8
	7/16-28	11,113	90	20	8	6,2	9	3	★ -UNEF7/16
	1/2-28	12,7	100	21	9	7	10	4	★ -UNEF1/2
	9/16-24	14,288	100	21	11	9	12	4	★ -UNEF9/16
	5/8-24	15,875	100	21	12	9	12	4	★ -UNEF5/8
	11/16-24	17,463	110	24	14	11	14	4	★ -UNEF11/16
	3/4-20	19,05	110	24	14	11	14	4	★ -UNEF3/4
	7/8-20	22,225	125	24	18	14,5	17	4	★ -UNEF7/8

★ New addition to range



Machine tap Paradur® Eco Plus



$\leq 3 \times D_N$

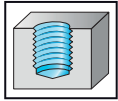

- HSS-E-PM
- Chamfer form C = 2 - 3 thread
- 45° helix angle
- Long-chipping materials from 500 to 1250 N/mm² or 38 HRC
- For long-chipping materials

UNF

ASME B1.1

	P	M	K	N	S	H	O
THL	●●	●●	●●	●●			

~DIN 2184-1 2B		D_N -P Nom	D_N mm	l_1 js16 mm	L_c mm	l_3 ± 1 mm	d_1 h9 mm	\square h12 mm	l_g mm	N	THL Designation EP2351302
	Nr. 4-48		2,845	56	6	11	3,5	2,7	6	3	★ -UNF4
	Nr. 6-40		3,505	56	6,5	13,1	4	3	6	3	★ -UNF6
	Nr. 8-36		4,166	63	7	17,4	4,5	3,4	6	3	★ -UNF8
	Nr.10-32		4,826	70	8	20,7	6	4,9	8	3	★ -UNF10
	1/4-28		6,35	80	10	25,9	7	5,5	8	3	★ -UNF1/4

DIN 2184-1 2B		D_N -P Nom	D_N mm	l_1 js16 mm	L_c mm	l_3 ± 1 mm	d_1 h9 mm	\square h12 mm	l_g mm	N	THL Designation EP2356302
	5/16-24		7,938	90	12	-	6	4,9	8	3	★ -UNF5/16
	3/8-24		9,525	100	15	-	7	5,5	8	3	★ -UNF3/8
	1/2-20		12,7	100	13	-	9	7	10	4	★ -UNF1/2
	5/8-18		15,875	100	15	-	12	9	12	4	★ -UNF5/8

★ New addition to range

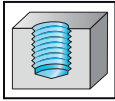

Machine tap Paradur® Eco Plus

 $\leq 3 \times D_N$

- HSS-E-PM
- Chamfer form C = 2 - 3 thread
- 45° helix angle
- Long-chipping materials from 500 to 1250 N/mm² or 38 HRC
- For long-chipping materials

UNF

ASME B1.1

	P	M	K	N	S	H	O
THL	●●	●●	●●	●●			

~DIN 2184-1 2B	D _N -P Nom	D _N mm	l ₁ js16 mm	L _c mm	l ₃ ±1 mm	d ₁ h9 mm	□ h12 mm	l _g mm	N	THL Designation EP2351312
	1/4-28	6,35	80	10	25,9	7	5,5	8	3	★ -UNF1/4

DIN 2184-1 2B	D _N -P Nom	D _N mm	l ₁ js16 mm	L _c mm	l ₃ ±1 mm	d ₁ h9 mm	□ h12 mm	l _g mm	N	THL Designation EP2356312
	5/16-24	7,938	90	12	-	6	4,9	8	3	★ -UNF5/16
	3/8-24	9,525	100	15	-	7	5,5	8	3	★ -UNF3/8
	1/2-20	12,7	100	13	-	9	7	10	4	★ -UNF1/2
	5/8-18	15,875	100	15	-	12	9	12	4	★ -UNF5/8

★ New addition to range



Machine tap Paradur® Eco Plus



$\leq 3 \times D_N$

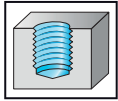

- HSS-E-PM
- Chamfer form C = 2 - 3 thread
- 45° helix angle
- Long-chipping materials from 500 to 1250 N/mm² or 38 HRC

UNF

ASME B1.1

	P	M	K	N	S	H	O
THL	●●	●●	●●	●●			

DIN/ANSI 2B	D_N -TPI Nom	D_N inch	l_1 inch	L_c js16 inch	l_3 inch	d_1 h9 inch	\square h12 inch	l_g inch	N	THL Designation AEP2351302
	No. 6-40	0.138	2.205	0.256	0.516	0.141	0.110	3/16	3	★ -UNF6
	No. 10-32	0.190	2.756	0.315	0.791	0.194	0.152	1/4	3	★ -UNF10
	1/4-28	0.250	3.150	0.394	1.020	0.255	0.191	5/16	3	★ -UNF1/4
	5/16-24	0.313	3.543	0.472	1.378	0.318	0.238	3/8	3	★ -UNF5/16
	3/8-24	0.375	3.937	0.472	1.535	0.381	0.286	7/16	3	★ -UNF3/8

DIN/ANSI 2B	D_N -TPI Nom	D_N inch	l_1 inch	L_c js16 inch	l_3 inch	d_1 h9 inch	\square h12 inch	l_g inch	N	THL Designation AEP2356302
	7/16-20	0.438	3.937	0.591	-	0.323	0.242	13/32	3	★ -UNF7/16
	1/2-20	0.500	3.937	0.512	-	0.367	0.275	7/16	4	★ -UNF1/2
	5/8-18	0.625	3.937	0.591	-	0.480	0.360	9/16	4	★ -UNF5/8

★ New addition to range



Machine tap Paradur® Eco Plus



$\leq 3 \times D_N$

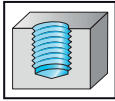

- HSS-E-PM
- Chamfer form C = 2 - 3 thread
- 45° helix angle
- Long-chipping materials from 500 to 1250 N/mm² or 38 HRC

UNF

ASME B1.1

	P	M	K	N	S	H	O
THL	●	●	●	●			

DIN/ANSI 2B	D _N -TPI Nom	D _N inch	l ₁ inch	L _c js16 inch	l ₃ inch	d ₁ h9 inch	□ h12 inch	l _g inch	N	THL Designation AE2351312
	1/4-28	0.250	3.150	0.394	1.020	0.255	0.191	5/16	3	★ -UNF1/4
	5/16-24	0.313	3.543	0.472	1.378	0.318	0.238	3/8	3	★ -UNF5/16
	3/8-24	0.375	3.937	0.472	1.535	0.381	0.286	7/16	3	★ -UNF3/8

DIN/ANSI 2B	D _N -TPI Nom	D _N inch	l ₁ inch	L _c js16 inch	l ₃ inch	d ₁ h9 inch	□ h12 inch	l _g inch	N	THL Designation AE2356312
	7/16-20	0.438	3.937	0.591	-	0.323	0.242	13/32	3	★ -UNF7/16
	1/2-20	0.500	3.937	0.512	-	0.367	0.275	7/16	4	★ -UNF1/2
	5/8-18	0.625	3.937	0.591	-	0.480	0.360	9/16	4	★ -UNF5/8
	3/4-16	0.750	4.331	0.669	-	0.590	0.442	11/16	4	★ -UNF3/4

★ New addition to range



Machine tap Paradur® X-pert P



$\leq 3 \times D_N$

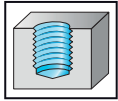

- HSS-E
- Chamfer form C = 2 - 3 thread
- 45° helix angle
- Materials from 200 to 1000 N/mm² or 32 HRC
- For long-chipping materials

UNF

ASME B1.1

	P	M	K	N	S	H	O
uncoated	●	●	●	●	●	●	●
TiN	●	●	●	●	●	●	●

DIN 2184-1 2B		D _N -P Nom	D _N mm	l ₁ js16 mm	L _c mm	l ₃ ±1 mm	d ₁ h9 mm	□ h12 mm	l _g mm	N	uncoated Designation P23519	TiN Designation P2351905
	Nr. 1-72	1,854	45	4	9	2,8	2,1	5	3	★ -UNF1		
	Nr. 2-64	2,184	45	4	12	2,8	2,1	5	3	★ -UNF2		
	Nr. 3-56	2,515	50	4	12,5	2,8	2,1	5	3	★ -UNF3		
	Nr. 4-48	2,845	56	6	18	3,5	2,7	6	3	★ -UNF4		
	Nr. 5-44	3,175	56	6	18	3,5	2,7	6	3	★ -UNF5		
	Nr. 6-40	3,505	56	6,5	20	4	3	6	3	★ -UNF6		
	Nr. 8-36	4,166	63	7	21	4,5	3,4	6	3	★ -UNF8		
	Nr.10-32	4,826	70	8	25	6	4,9	8	3	★ -UNF10	★ -UNF10	
	Nr.12-28	5,486	80	10	30	6	4,9	8	3	★ -UNF12		
	1/4-28	6,35	80	10	30	7	5,5	8	3	★ -UNF1/4	★ -UNF1/4	

DIN 2184-1 2B		D _N -P Nom	D _N mm	l ₁ js16 mm	L _c mm	l ₃ ±1 mm	d ₁ h9 mm	□ h12 mm	l _g mm	N	uncoated Designation P23569	TiN Designation P2356905
	5/16-24	7,938	90	12	-	6	4,9	8	3	★ -UNF5/16	★ -UNF5/16	
	3/8-24	9,525	100	15	-	7	5,5	8	3	★ -UNF3/8	★ -UNF3/8	
	7/16-20	11,113	100	15	-	8	6,2	9	3	★ -UNF7/16	★ -UNF7/16	
	1/2-20	12,7	100	13	-	9	7	10	4	★ -UNF1/2	★ -UNF1/2	
	9/16-18	14,288	100	15	-	11	9	12	4	★ -UNF9/16	★ -UNF9/16	
	5/8-18	15,875	100	15	-	12	9	12	4	★ -UNF5/8	★ -UNF5/8	
	3/4-16	19,05	110	17	-	14	11	14	4	★ -UNF3/4	★ -UNF3/4	
	7/8-14	22,225	125	18	-	18	14,5	17	4	★ -UNF7/8	★ -UNF7/8	
	1-12	25,4	140	20	-	18	14,5	17	5	★ -UNF1		
	1 1/8-12	28,575	150	20	-	22	18	21	5	★ -UNF1.1/8		
	1 1/4-12	31,75	150	20	-	22	18	21	5	★ -UNF1.1/4		
	1 3/8-12	34,925	170	22	-	28	22	25	5	★ -UNF1.3/8		
	1 1/2-12	38,1	170	22	-	28	22	25	5	★ -UNF1.1/2		

★ New addition to range



Machine tap Paradur® X-pert M

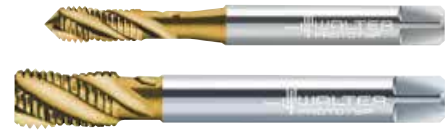

$\leq 2,5 \times D_N$

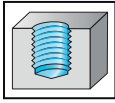

- HSS-E
- Chamfer form C = 2 - 3 thread
- 40° helix angle
- Materials from 350 to 1200 N/mm² or 36 HRC
- For long-chipping materials

UNF

ASME B1.1

	P	M	K	N	S	H	O
vap	●	●●	■	■	■	■	■
TiN	●	●●	■	■	■	■	■

DIN 2184-1 2B		D_N -P Nom	D_N mm	l_1 js16 mm	L_c mm	l_3 ± 1 mm	d_1 h9 mm	\square h12 mm	l_g mm	N	VAP Designation M23513	TiN Designation M2351305
	Nr. 6-40	3,505	56	6,5	20	4	3	6	3	★ -UNF6	★ -UNF6	
	Nr. 8-36	4,166	63	7	21	4,5	3,4	6	3	★ -UNF8	★ -UNF8	
	Nr.10-32	4,826	70	8	25	6	4,9	8	3	★ -UNF10	★ -UNF10	
	Nr.12-28	5,486	80	10	30	6	4,9	8	3	★ -UNF12	★ -UNF12	
	1/4-28	6,35	80	10	30	7	5,5	8	3	★ -UNF1/4	★ -UNF1/4	

DIN 2184-1 2B		D_N -P Nom	D_N mm	l_1 js16 mm	L_c mm	l_3 ± 1 mm	d_1 h9 mm	\square h12 mm	l_g mm	N	VAP Designation M23563	TiN Designation M2356305
	5/16-24	7,938	90	12	-	6	4,9	8	3	★ -UNF5/16	★ -UNF5/16	
	3/8-24	9,525	100	15	-	7	5,5	8	3	★ -UNF3/8	★ -UNF3/8	
	7/16-20	11,113	100	15	-	8	6,2	9	3	★ -UNF7/16	★ -UNF7/16	
	1/2-20	12,7	100	13	-	9	7	10	4	★ -UNF1/2	★ -UNF1/2	
	9/16-18	14,288	100	15	-	11	9	12	4	★ -UNF9/16	★ -UNF9/16	
	5/8-18	15,875	100	15	-	12	9	12	4	★ -UNF5/8	★ -UNF5/8	
	3/4-16	19,05	110	17	-	14	11	14	4	★ -UNF3/4	★ -UNF3/4	
	7/8-14	22,225	125	18	-	18	14,5	17	4	★ -UNF7/8	★ -UNF7/8	
1-12	25,4	140	20	-	18	14,5	17	5	★ -UNF1	★ -UNF1		

★ New addition to range



Machine tap Paradur® X-pert P

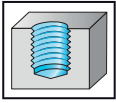

 $\leq 3 \times D_N$

- HSS-E
- Chamfer form C = 2 - 3 thread
- 45° helix angle
- Materials from 200 to 1000 N/mm² or 32 HRC
- For long-chipping materials

UNEF

ASME B1.1

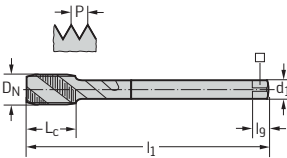
	P	M	K	N	S	H	O
uncoated	●●			●			●

DIN 2184-1 2B	D _N -P Nom	D _N mm	l ₁ js16 mm	L _c mm	d ₁ h9 mm	□ h12 mm	l _g mm	N	uncoated Designation P235692
	1/4-32	6,35	80	10	4,5	3,4	6	3	★ -UNEF1/4
	5/16-32	7,938	90	12	6	4,9	8	3	★ -UNEF5/16
	3/8-32	9,525	90	12	7	5,5	8	3	★ -UNEF3/8
	7/16-28	11,113	90	15	8	6,2	9	3	★ -UNEF7/16
	1/2-28	12,7	100	13	9	7	10	4	★ -UNEF1/2
	9/16-24	14,288	100	15	11	9	12	4	★ -UNEF9/16
	5/8-24	15,875	100	15	12	9	12	4	★ -UNEF5/8
	11/16-24	17,463	110	17	14	11	14	4	★ -UNEF11/16
	3/4-20	19,05	110	17	14	11	14	4	★ -UNEF3/4
	7/8-20	22,225	125	18	18	14,5	17	4	★ -UNEF7/8
	1-20	25,4	140	20	18	14,5	17	5	★ -UNEF1

★ New addition to range

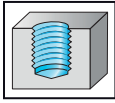

Machine tap Paradur® X-pert P

 $\leq 3 \times D_N$

- HSS-E
- Chamfer form C = 2 - 3 thread
- 45° helix angle
- Materials from 200 to 1000 N/mm² or 32 HRC
- For long-chipping materials

UN - 8

ASME B1.1

	P	M	K	N	S	H	O
uncoated	●●			●			●

DIN 2184-1 2B	D _N -P Nom	D _N mm	l ₁ js16 mm	L _c mm	d ₁ h9 mm	□ h12 mm	l _g mm	N	uncoated Designation P265676
	1 1/8-8	28,575	180	30	22	18	21	5	★ -UN1.1/8
	1 1/4-8	31,75	180	30	22	18	21	5	★ -UN1.1/4
	1 3/8-8	34,925	200	30	28	22	25	5	★ -UN1.3/8
	1 1/2-8	38,1	200	30	28	22	25	5	★ -UN1.1/2
	1 5/8-8	41,275	200	33	32	24	27	6	★ -UN1.5/8
	1 3/4-8	44,45	200	33	36	29	32	6	★ -UN1.3/4
	1 7/8-8	47,625	225	36	36	29	32	6	★ -UN1.7/8
	2-8	50,8	225	36	40	32	35	6	★ -UN2
	2 1/4-8	57,15	250	36	45	35	38	6	★ -UN2.1/4

★ New addition to range



Machine tap Paradur® X-pert M



$\leq 2,5 \times D_N$

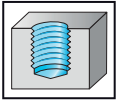

- HSS-E
- Chamfer form C = 2 - 3 thread
- 40° helix angle
- Materials from 350 to 1200 N/mm² or 36 HRC
- For long-chipping materials

UN - 8

ASME B1.1

	P	M	K	N	S	H	O
vap	●	●●	●	●	●	●	●

DIN 2184-1 2B	D _N -P Nom	D _N mm	l ₁ js16 mm	L _c mm	d ₁ h9 mm	□ h12 mm	l _g mm	N	VAP Designation M225632
	1-8	25,4	160	30	18	14,5	17	4	★ -UN1
	1 1/8-8	28,575	180	30	22	18	21	4	★ -UN1.1/8
	1 1/4-8	31,75	180	30	22	18	21	4	★ -UN1.1/4
	1 3/8-8	34,925	200	30	28	22	25	5	★ -UN1.3/8
	1 1/2-8	38,1	200	30	28	22	25	5	★ -UN1.1/2
	1 5/8-8	41,275	200	33	32	24	27	5	★ -UN1.5/8
	1 3/4-8	44,45	200	33	36	29	32	6	★ -UN1.3/4
	1 7/8-8	47,625	225	36	36	29	32	6	★ -UN1.7/8
	2-8	50,8	225	36	40	32	35	6	★ -UN2

★ New addition to range

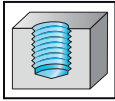

Machine tap Paradur® X-pert M

 $\leq 2,5 \times D_N$

- HSS-E
- Chamfer form C = 2 - 3 thread
- 40° helix angle
- Materials from 350 to 1200 N/mm² or 36 HRC
- For long-chipping materials

UN - 8

ASME B1.1

	P	M	K	N	S	H	O
vap	●	●●	■	■	■	■	■

DIN 2184-1 3B	D _N -P Nom	D _N mm	l ₁ js16 mm	d ₁ h9 mm	□ h12 mm	l _g mm	N	VAP Designation M225532
	UN1	25,4	160	18	14,5	17	4	★ -UN1
	UN1.1/8	28,575	180	22	18	21	4	★ -UN1.1/8
	UN1.1/4	31,75	180	22	18	21	4	★ -UN1.1/4
	UN1.3/8	34,925	200	28	22	25	5	★ -UN1.3/8

★ New addition to range



Machine tap Prototex® Eco Plus



$\leq 3,5 \times D_N$

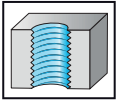

- HSS-E-PM
- Chamfer form B = 3.5 - 5 thread
- Materials from 500 to 1350 N/mm² or 42 HRC
- For long-chipping materials

G

DIN EN ISO 228

	P	M	K	N	S	H	O
THL	●●	●●	●●	●●			

DIN 5156 G-X		D_N Nom	D_N mm	Threads per inch	l_1 js16 mm	L_c mm	d_1 h9 mm	\square h12 mm	l_g mm	N	THL Designation EP2426302
	G 1/8	9,728	28	90	20	7	5,5	8	3	★ -G1/8	
	G 1/4	13,157	19	100	21	11	9	12	4	★ -G1/4	
	G 3/8	16,662	19	100	21	12	9	12	4	★ -G3/8	
	G 1/2	20,955	14	125	24	16	12	15	4	★ -G1/2	
	G 5/8	22,911	14	125	24	18	14,5	17	4	★ -G5/8	
	G 3/4	26,441	14	140	26	20	16	19	5	★ -G3/4	
	G 1	33,249	11	160	28	25	20	23	5	★ -G1	

★ New addition to range

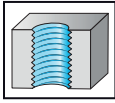

Machine tap Prototex® X-pert P

 $\leq 3 \times D_N$

- HSS-E
- Chamfer form B = 3.5 - 5 thread
- Materials from 200 to 1000 N/mm² or 32 HRC
- For long-chipping materials

G

DIN EN ISO 228

	P	M	K	N	S	H	O
uncoated	●●	●	●	●	●	●	●
TiN	●●	●	●	●	●	●	●

DIN 5156	D _N Nom	D _N mm	Threads per inch	l ₁ js16 mm	L _c mm	d ₁ h9 mm	□ h12 mm	l _g mm	N	uncoated	TiN
										Designation P24360	Designation P2436005
	G 1/8	9,728	28	90	20	7	5,5	8	3	★ -G1/8	★ -G1/8
	G 1/4	13,157	19	100	21	11	9	12	3	★ -G1/4	★ -G1/4
	G 3/8	16,662	19	100	21	12	9	12	4	★ -G3/8	★ -G3/8
	G 1/2	20,955	14	125	24	16	12	15	4	★ -G1/2	★ -G1/2
	G 5/8	22,911	14	125	24	18	14,5	17	4	★ -G5/8	
	G 3/4	26,441	14	140	26	20	16	19	4	★ -G3/4	★ -G3/4
	G 7/8	30,201	14	150	26	22	18	21	4	★ -G7/8	
	G 1	33,249	11	160	28	25	20	23	4	★ -G1	★ -G1
	G 1 1/4	41,91	11	170	28	32	24	27	4	★ -G1.1/4	
	G 1 1/2	47,803	11	190	30	36	29	32	5	★ -G1.1/2	
	G 1 3/4	53,746	11	190	32	40	32	35	5	★ -G1.3/4	
	G 2	59,614	11	220	34	45	35	38	5	★ -G2	

★ New addition to range



Machine tap Prototex® X-pert M



$\leq 3 \times D_N$

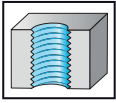

- HSS-E
- Chamfer form B = 3.5 - 5 thread
- Materials from 350 to 1200 N/mm² or 36 HRC
- For long-chipping materials

G

DIN EN ISO 228

	P	M	K	N	S	H	O
vap	●	●●	●	●	●	●	●
TiN	●	●●	●	●	●	●	●

DIN 5156	D _N Nom	D _N mm	Threads per inch	l ₁ js16 mm	L _c mm	d ₁ h9 mm	□ h12 mm	l _g mm	N	VAP	TIN
										Designation M24263	Designation M2426305
	G 1/8	9,728	28	90	20	7	5,5	8	3	★ -G1/8	★ -G1/8
	G 1/4	13,157	19	100	21	11	9	12	4	★ -G1/4	★ -G1/4
	G 3/8	16,662	19	100	21	12	9	12	4	★ -G3/8	★ -G3/8
	G 1/2	20,955	14	125	24	16	12	15	4	★ -G1/2	★ -G1/2
	G 5/8	22,911	14	125	24	18	14,5	17	4	★ -G5/8	
	G 3/4	26,441	14	140	26	20	16	19	4	★ -G3/4	★ -G3/4
	G 1	33,249	11	160	28	25	20	23	5	★ -G1	★ -G1

★ New addition to range

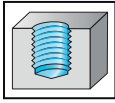

Machine tap Paradur® Eco Plus

 $\leq 3 \times D_N$

- HSS-E-PM
- Chamfer form C = 2 - 3 thread
- 45° helix angle
- Long-chipping materials from 500 to 1250 N/mm² or 38 HRC
- For long-chipping materials

G

DIN EN ISO 228

	P	M	K	N	S	H	O
THL	●●	●●	●●	●●			

DIN 5156 G-X	D _N Nom	D _N mm	Threads per inch	l ₁ js16 mm	L _c mm	d ₁ h9 mm	□ h12 mm	l _g mm	N	THL Designation EP2456302
	G 1/8	9,728	28	90	12	7	5,5	8	3	★ -G1/8
	G 1/4	13,157	19	100	15	11	9	12	4	★ -G1/4
	G 3/8	16,662	19	100	15	12	9	12	4	★ -G3/8
	G 1/2	20,955	14	125	18	16	12	15	4	★ -G1/2
	G 5/8	22,911	14	125	18	18	14,5	17	4	★ -G5/8
	G 3/4	26,441	14	140	20	20	16	19	5	★ -G3/4
	G 1	33,249	11	160	22	25	20	23	5	★ -G1

★ New addition to range



G-2



D-140

Machine tap Paradur® X-pert P



$\leq 3 \times D_N$

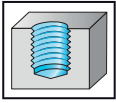

- HSS-E
- Chamfer form C = 2 - 3 thread
- 40° helix angle
- Materials from 200 to 1000 N/mm² or 32 HRC
- For long-chipping materials

G

DIN EN ISO 228

	P	M	K	N	S	H	O
uncoated	●	●	●	●	●	●	●
TiN	●	●	●	●	●	●	●

DIN 5156	D _N Nom	D _N mm	Threads per inch	l ₁ js16 mm	L _c mm	d ₁ h9 mm	□ h12 mm	l _g mm	N	uncoated	TiN
										Designation P24569	Designation P2456905
	G 1/8	9,728	28	90	12	7	5,5	8	3	★ -G1/8	★ -G1/8
	G 1/4	13,157	19	100	15	11	9	12	4	★ -G1/4	★ -G1/4
	G 3/8	16,662	19	100	15	12	9	12	4	★ -G3/8	★ -G3/8
	G 1/2	20,955	14	125	18	16	12	15	4	★ -G1/2	★ -G1/2
	G 5/8	22,911	14	125	18	18	14,5	17	4	★ -G5/8	
	G 3/4	26,441	14	140	20	20	16	19	5	★ -G3/4	★ -G3/4
	G 7/8	30,201	14	150	20	22	18	21	5	★ -G7/8	
	G 1	33,249	11	160	22	25	20	23	5	★ -G1	★ -G1
	G 1 1/8	37,897	11	170	22	28	22	25	5	★ -G1.1/8	
	G 1 1/4	41,91	11	170	22	32	24	27	6	★ -G1.1/4	
	G 1 1/2	47,803	11	190	24	36	29	32	6	★ -G1.1/2	
	G 1 3/4	53,746	11	190	26	40	32	35	6	★ -G1.3/4	
	G 2	59,614	11	220	28	45	35	38	6	★ -G2	

★ New addition to range

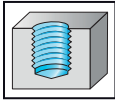

Machine tap Paradur® X-pert M

 $\leq 2,5 \times D_N$

- HSS-E
- Chamfer form C = 2 - 3 thread
- 40° helix angle
- Materials from 350 to 1200 N/mm² or 36 HRC
- For long-chipping materials

G

DIN EN ISO 228

	P	M	K	N	S	H	O
vap	●	●●	●	●	●	●	●
TiN	●	●●	●	●	●	●	●

DIN 5156	D _N Nom	D _N mm	Threads per inch	l ₁ js16 mm	L _c mm	d ₁ h9 mm	□ h12 mm	l _g mm	N	VAP	TiN
										Designation M24563	Designation M2456305
	G 1/8	9,728	28	90	12	7	5,5	8	3	★ -G1/8	★ -G1/8
	G 1/4	13,157	19	100	15	11	9	12	4	★ -G1/4	★ -G1/4
	G 3/8	16,662	19	100	15	12	9	12	4	★ -G3/8	★ -G3/8
	G 1/2	20,955	14	125	18	16	12	15	4	★ -G1/2	★ -G1/2
	G 5/8	22,911	14	125	18	18	14,5	17	4	★ -G5/8	
	G 3/4	26,441	14	140	20	20	16	19	5	★ -G3/4	★ -G3/4
	G 7/8	30,201	14	150	20	22	18	21	5	★ -G7/8	
	G 1	33,249	11	160	22	25	20	23	5	★ -G1	★ -G1

★ New addition to range



Machine tap Paradur® X-pert N



$\leq 3 \times D_N$

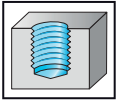

- HSS-E
- Chamfer form C = 2 - 3 thread
- 35° helix angle
- Materials from 200 to 700 N/mm² or 14 HRC
- For long-chipping materials

G

DIN EN ISO 228

	P	M	K	N	S	H	O
uncoated				●●	●		●

DIN 5156	D _N Nom	D _N mm	Threads per inch	l ₁ js16 mm	L _c mm	d ₁ h9 mm	□ h12 mm	l _g mm	N	uncoated Designation N24566
	G 1/8	9,728	28	90	12	7	5,5	8	3	★ -G1/8

★ New addition to range

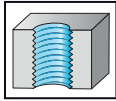

Machine tap Prototex® X-pert P

 $\leq 3 \times D_N$

- HSS-E
- Chamfer form B = 3.5 - 5 thread
- Materials from 200 to 1000 N/mm² or 32 HRC
- For long-chipping materials

BSW

BS84

	P	M	K	N	S	H	O
uncoated	●	●	●	●	●	●	●

DIN 2184-1 mc	D _N Nom	D _N mm	Threads per inch	l ₁ js16 mm	L _c mm	l ₃ ±1 mm	d ₁ h9 mm	□ h12 mm	l _g mm	N	uncoated Designation P28210
	1/8-40	3,175	40	56	10	18	3,5	2,7	6	2	★ -BSW1/8
	3/16-24	4,763	24	70	13	25	6	4,9	8	2	★ -BSW3/16
	1/4-20	6,35	20	80	15	30	7	5,5	8	3	★ -BSW1/4
	5/16-18	7,938	18	90	18	35	8	6,2	9	3	★ -BSW5/16
	3/8-16	9,525	16	100	20	39	10	8	11	3	★ -BSW3/8

DIN 2184-1 mc	D _N Nom	D _N mm	Threads per inch	l ₁ js16 mm	L _c mm	l ₃ ±1 mm	d ₁ h9 mm	□ h12 mm	l _g mm	N	uncoated Designation P28360
	7/16-14	11,113	14	100	20	-	8	6,2	9	3	★ -BSW7/16
	1/2-12	12,7	12	110	23	-	9	7	10	3	★ -BSW1/2
	5/8-11	15,875	11	110	25	-	12	9	12	3	★ -BSW5/8
	3/4-10	19,05	10	125	30	-	14	11	14	4	★ -BSW3/4
	7/8-9	22,225	9	140	30	-	18	14,5	17	4	★ -BSW7/8
	1-8	25,4	8	160	36	-	18	14,5	17	4	★ -BSW1

★ New addition to range



Machine tap Paradur® X-pert P

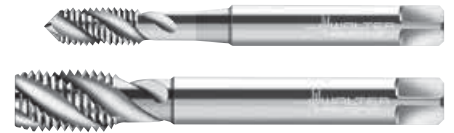

$\leq 3 \times D_N$

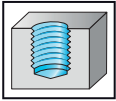

- HSS-E
- Chamfer form C = 2 - 3 thread
- 45° helix angle
- Materials from 200 to 1000 N/mm² or 32 HRC
- For long-chipping materials

BSW

BS84

	P	M	K	N	S	H	O
uncoated	●	●	●	●	●	●	●

DIN 2184-1 mc	D _N Nom	D _N mm	Threads per inch	l ₁ js16 mm	L _C mm	l ₃ ±1 mm	d ₁ h9 mm	□ h12 mm	l _g mm	N	uncoated Designation P28519
	1/8-40	3,175	40	56	6	18	3,5	2,7	6	3	★ -BSW1/8
	3/16-24	4,763	24	70	8	25	6	4,9	8	3	★ -BSW3/16
	1/4-20	6,35	20	80	10	30	7	5,5	8	3	★ -BSW1/4
	5/16-18	7,938	18	90	12	35	8	6,2	9	3	★ -BSW5/16
	3/8-16	9,525	16	100	15	39	10	8	11	3	★ -BSW3/8

DIN 2184-1 mc	D _N Nom	D _N mm	Threads per inch	l ₁ js16 mm	L _C mm	l ₃ ±1 mm	d ₁ h9 mm	□ h12 mm	l _g mm	N	uncoated Designation P28569
	7/16-14	11,113	14	100	15	-	8	6,2	9	3	★ -BSW7/16
	1/2-12	12,7	12	110	18	-	9	7	10	3	★ -BSW1/2
	5/8-11	15,875	11	110	20	-	12	9	12	4	★ -BSW5/8
	3/4-10	19,05	10	125	25	-	14	11	14	4	★ -BSW3/4
	7/8-9	22,225	9	140	25	-	18	14,5	17	4	★ -BSW7/8
	1-8	25,4	8	160	30	-	18	14,5	17	4	★ -BSW1

★ New addition to range



Machine tap Prototex® X-pert P insert



$\leq 3 \times D_N$

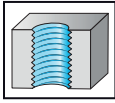

- HSS-E
- Chamfer form B = 3.5 - 5 thread
- Materials from 200 to 1000 N/mm² or 32 HRC
- For long-chipping materials

EgM

DIN 8140

	P	M	K	N	S	H	O
uncoated	●●			●			●

DIN 40 435 6H mod		D_N Nom	P mm	l_1 js16 mm	L_c mm	l_3 ± 1 mm	d_1 h9 mm	\square h12 mm	l_g mm	N	uncoated Designation P203009
	EG M 2,5	0,45	56	9	18	3,5	2,7	6	3	★ -EGM2.5	
	EG M 3	0,5	63	12	21	4,5	3,4	6	3	★ -EGM3	
	EG M 4	0,7	70	13	25	6	4,9	8	3	★ -EGM4	
	EG M 5	0,8	80	15	30	6	4,9	8	3	★ -EGM5	
	EG M 6	1	90	18	35	8	6,2	9	3	★ -EGM6	
	EG M 8	1,25	100	20	39	10	8	11	3	★ -EGM8	

DIN 40 435 6H mod		D_N Nom	P mm	l_1 js16 mm	L_c mm	l_3 ± 1 mm	d_1 h9 mm	\square h12 mm	l_g mm	N	uncoated Designation P203509
	EG M 10	1,5	100	21	-	9	7	10	3	★ -EGM10	
	EG M 12	1,75	110	25	-	11	9	12	3	★ -EGM12	
	EG M 16	2	125	30	-	14	11	14	4	★ -EGM16	

★ New addition to range



Machine tap Prototex® X-pert M insert



$\leq 3 \times D_N$

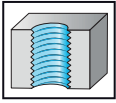

- HSS-E
- Chamfer form B = 3.5 - 5 thread
- Materials from 350 to 1200 N/mm² or 36 HRC
- For long-chipping materials

EgM

DIN 8140

	P	M	K	N	S	H	O
vap	●	●●	●	●	●	●	●

DIN 40 435 6H mod		D_N Nom	P mm	l_1 js16 mm	L_c mm	l_3 ± 1 mm	d_1 h9 mm	\square h12 mm	l_g mm	N	VAP Designation M203009
	EG M 2,5	0,45	56	9	18	3,5	2,7	6	2	★ -EGM2.5	
	EG M 3	0,5	63	12	21	4,5	3,4	6	2	★ -EGM3	
	EG M 4	0,7	70	13	25	6	4,9	8	3	★ -EGM4	
	EG M 5	0,8	80	15	30	6	4,9	8	3	★ -EGM5	
	EG M 6	1	90	18	35	8	6,2	9	3	★ -EGM6	
	EG M 8	1,25	100	20	39	10	8	11	3	★ -EGM8	

★ New addition to range



Machine tap Paradur® X-pert P insert



$\leq 3 \times D_N$

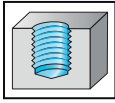

- HSS-E
- Chamfer form C = 2 - 3 thread
- 45° helix angle
- Materials from 200 to 1000 N/mm² or 32 HRC
- For long-chipping materials

EgM

DIN 8140

	P	M	K	N	S	H	O
uncoated	●	●	●	●	●	●	●

DIN 40 435 6H mod		D_N Nom	P mm	l_1 js16 mm	L_c mm	l_3 ± 1 mm	d_1 h9 mm	\square h12 mm	l_g mm	N	uncoated Designation P205099
	EG M 2,5	0,45	56	6	18	3,5	2,7	6	3	★ -EGM2.5	
	EG M 3	0,5	63	7	21	4,5	3,4	6	3	★ -EGM3	
	EG M 4	0,7	70	8	25	6	4,9	8	3	★ -EGM4	
	EG M 5	0,8	80	10	30	6	4,9	8	3	★ -EGM5	
	EG M 6	1	90	12	35	8	6,2	9	3	★ -EGM6	
	EG M 8	1,25	100	15	39	10	8	11	3	★ -EGM8	

DIN 40 435 6H mod		D_N Nom	P mm	l_1 js16 mm	L_c mm	l_3 ± 1 mm	d_1 h9 mm	\square h12 mm	l_g mm	N	uncoated Designation P205599
	EG M 10	1,5	100	13	-	9	7	10	4	★ -EGM10	
	EG M 12	1,75	110	20	-	11	9	12	4	★ -EGM12	
	EG M 14	2	110	20	-	12	9	12	4	★ -EGM14	
	EG M 16	2	125	25	-	14	11	14	4	★ -EGM16	
	EG M 20	2,5	160	25	-	18	14,5	17	4	★ -EGM20	
	EG M 24	3	160	30	-	20	16	19	4	★ -EGM24	

★ New addition to range



Machine tap Paradur® X-pert M insert



$\leq 3 \times D_N$

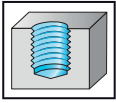

- HSS-E
- Chamfer form C = 2 - 3 thread
- 40° helix angle
- Materials from 350 to 1200 N/mm² or 36 HRC
- For long-chipping materials

EgM

DIN 8140

	P	M	K	N	S	H	O
vap	●	●●	■	■	■	■	■

DIN 40 435 6H mod		D _N Nom	P mm	l ₁ js16 mm	L _C mm	l ₃ ±1 mm	d ₁ h9 mm	□ h12 mm	l _g mm	N	VAP Designation M205049
	EG M 2,5	0,45	56	6	18	3,5	2,7	6	3	★ -EGM2.5	
	EG M 3	0,5	63	7	21	4,5	3,4	6	3	★ -EGM3	
	EG M 4	0,7	70	8	25	6	4,9	8	3	★ -EGM4	
	EG M 5	0,8	80	10	30	6	4,9	8	3	★ -EGM5	
	EG M 6	1	90	12	35	8	6,2	9	3	★ -EGM6	
	EG M 8	1,25	100	15	39	10	8	11	3	★ -EGM8	

DIN 40 435 6H mod		D _N Nom	P mm	l ₁ js16 mm	L _C mm	l ₃ ±1 mm	d ₁ h9 mm	□ h12 mm	l _g mm	N	VAP Designation M205549
	EG M 10	1,5	100	13	-	9	7	10	4	★ -EGM10	
	EG M 12	1,75	110	20	-	11	9	12	4	★ -EGM12	
	EG M 14	2	110	20	-	12	9	12	4	★ -EGM14	
	EG M 16	2	125	25	-	14	11	14	4	★ -EGM16	

★ New addition to range



Machine tap Paradur® X-pert N insert



$\leq 3 \times D_N$

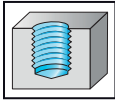

- HSS-E
- Chamfer form C = 2 - 3 thread
- 35° helix angle
- Materials from 200 to 700 N/mm² or 14 HRC
- For long-chipping materials

EgM

DIN 8140

	P	M	K	N	S	H	O
uncoated				●●	●		●

DIN 40 435 6H mod		D_N Nom	P mm	l_1 js16 mm	L_c mm	l_3 ± 1 mm	d_1 h9 mm	\square h12 mm	l_g mm	N	uncoated Designation N205069
	EG M 2,5	0,45	56	6	18	3,5	2,7	6	2	-EGM2.5	
	EG M 3	0,5	63	7	21	4,5	3,4	6	2	-EGM3	
	EG M 4	0,7	70	8	25	6	4,9	8	2	-EGM4	
	EG M 5	0,8	80	10	30	6	4,9	8	3	-EGM5	
	EG M 6	1	90	12	35	8	6,2	9	3	-EGM6	
	EG M 8	1,25	100	15	39	10	8	11	3	-EGM8	

DIN 40 435 6H mod		D_N Nom	P mm	l_1 js16 mm	L_c mm	l_3 ± 1 mm	d_1 h9 mm	\square h12 mm	l_g mm	N	uncoated Designation N205569
	EG M 10	1,5	100	13	-	9	7	10	3	-EGM10	
	EG M 12	1,75	110	20	-	11	9	12	3	-EGM12	
	EG M 16	2	125	25	-	14	11	14	4	-EGM16	



Machine tap Paradur® X-pert P insert



$\leq 3 \times D_N$

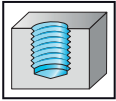

- HSS-E
- Chamfer form C = 2 - 3 thread
- 45° helix angle
- Materials from 200 to 1000 N/mm² or 32 HRC
- For long-chipping materials

EgMF

DIN 8140

	P	M	K	N	S	H	O
uncoated	●●			●			●

DIN 40 435 6H mod		D_N Nom	P mm	l_1 js16 mm	L_c mm	d_1 h9 mm	\square h12 mm	l_g mm	N	uncoated Designation P215599
	EG M 8		1	90	12	7	5,5	8	3	★ -EGM8X1
	EG M 10		1	100	13	9	7	10	3	★ -EGM10X1
	EG M 12		1,5	100	15	11	9	12	4	★ -EGM12X1.5
	EG M 14		1,5	100	15	12	9	12	4	★ -EGM14X1.5
	EG M 16		1,5	110	17	14	11	14	4	★ -EGM16X1.5

★ New addition to range

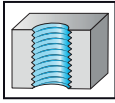

Machine tap Prototex® X-pert P insert

 $\leq 3 \times D_N$

- HSS-E
- Chamfer form B = 3.5 - 5 thread
- Materials from 200 to 1000 N/mm² or 32 HRC
- For long-chipping materials

EgUNC

NASM 33537

	P	M	K	N	S	H	O
uncoated	●	●	●	●	●	●	●

DIN 2184-1 3B	D _N -P Nom	D _N mm	l ₁ js16 mm	L _c mm	l ₃ ±1 mm	d ₁ h9 mm	□ h12 mm	l _g mm	N	uncoated Designation P223009
	EG no. 6-32	4,536	70	13	25	6	4,9	8	3	★ -EGUNC6
	EG no. 8-32	5,197	80	15	30	6	4,9	8	3	★ -EGUNC8
	EG no. 10-24	6,201	80	15	30	7	5,5	8	3	★ -EGUNC10
	EG 1/4-20	8	90	18	35	8	6,2	9	3	★ -EGUNC1/4

★ New addition to range



Machine tap Paradur® X-pert P insert



$\leq 3 \times D_N$

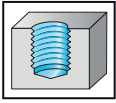

- HSS-E
- Chamfer form C = 2 - 3 thread
- 45° helix angle
- Materials from 200 to 1000 N/mm² or 32 HRC
- For long-chipping materials

EgUNC

NASM 33537

	P	M	K	N	S	H	O
uncoated	●	●	●	●	●	●	●

DIN 2184-1 3B	D _N -P Nom	D _N mm	l ₁ js16 mm	L _c mm	l ₃ ±1 mm	d ₁ h9 mm	□ h12 mm	l _g mm	N	uncoated Designation P225099
	EG no. 6-32	4,536	70	8	25	6	4,9	8	3	★ -EGUNC6
	EG no. 8-32	5,197	80	10	30	6	4,9	8	3	★ -EGUNC8
	EG no. 10-24	6,201	80	10	30	7	5,5	8	3	★ -EGUNC10
	EG 1/4-20	8	90	12	35	8	6,2	9	3	★ -EGUNC1/4

★ New addition to range



Machine tap Paradur® X-pert N insert



$\leq 3 \times D_N$

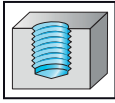

- HSS-E
- Chamfer form C = 2 - 3 thread
- 35° helix angle
- Materials from 200 to 700 N/mm² or 14 HRC
- For long-chipping materials

EgUNC

NASM 33537

	P	M	K	N	S	H	O
uncoated				●●	●		●

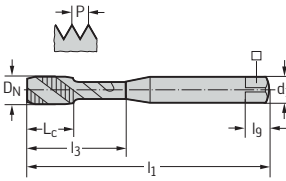
DIN 2184-1 3B	D _N -P Nom	D _N mm	l ₁ js16 mm	L _c mm	l ₃ ±1 mm	d ₁ h9 mm	□ h12 mm	l _g mm	N	uncoated Designation N225069
	EG no. 6-32	4,536	70	8	25	6	4,9	8	2	-EGUNC6
	EG no. 8-32	5,197	80	10	30	6	4,9	8	2	-EGUNC8
	EG no. 10-24	6,201	80	10	30	7	5,5	8	2	-EGUNC10
	EG 1/4-20	8	90	12	35	8	6,2	9	2	-EGUNC1/4

★ New addition to range



Machine tap Prototex® X-pert P insert



$\leq 3 \times D_N$

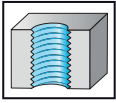

- HSS-E
- Chamfer form B = 3.5 - 5 thread
- Materials from 200 to 1000 N/mm² or 32 HRC
- For long-chipping materials

EgUNF

NASM 33537

	P	M	K	N	S	H	O
uncoated	●●			●			●

DIN 2184-1 3B	D _N -P Nom	D _N mm	l ₁ js16 mm	L _c mm	l ₃ ±1 mm	d ₁ h9 mm	□ h12 mm	l _g mm	N	uncoated Designation P233009
	EG no. 6-40	4,33	70	13	25	6	4,9	8	3	★ -EGUNF6
	EG no. 8-36	5,083	80	15	30	6	4,9	8	3	★ -EGUNF8
	EG no. 10-32	5,857	80	15	30	6	4,9	8	3	★ -EGUNF10
	EG 1/4-28	7,528	90	18	35	8	6,2	9	3	★ -EGUNF1/4

DIN 2184-1 3B	D _N -P Nom	D _N mm	l ₁ js16 mm	L _c mm	l ₃ ±1 mm	d ₁ h9 mm	□ h12 mm	l _g mm	N	uncoated Designation P233509
	EG 5/16-24	9,313	90	20	-	7	5,5	8	3	★ -EGUNF5/16
	EG 3/8-24	10,9	90	20	-	8	6,2	9	3	★ -EGUNF3/8
	EG 7/16-20	12,763	100	21	-	9	7	10	4	★ -EGUNF7/16
	EG 1/2-20	14,35	100	21	-	11	9	12	4	★ -EGUNF1/2

★ New addition to range



Machine tap Prototex® X-pert M insert



$\leq 3 \times D_N$

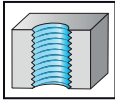







- HSS-E
- Chamfer form B = 3.5 - 5 thread
- Materials from 350 to 1200 N/mm² or 36 HRC
- For long-chipping materials

EgUNF

NASM 33537

	P	M	K	N	S	H	O
vap	●	●●	●	●	●	●	●

DIN 2184-1 3B	D _N -P Nom	D _N mm	l ₁ js16 mm	L _c mm	l ₃ ±1 mm	d ₁ h9 mm	□ h12 mm	l _g mm	N	VAP Designation M233009
	EG no. 8-36	5,083	80	15	30	6	4,9	8	3	★ -EGUNF8
	EG no. 10-32	5,857	80	15	30	6	4,9	8	3	★ -EGUNF10
	EG 1/4-28	7,528	90	18	35	8	6,2	9	3	★ -EGUNF1/4
										
										
										

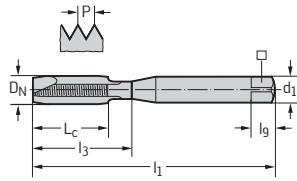

★ New addition to range



Machine tap Paradur® X-pert P insert

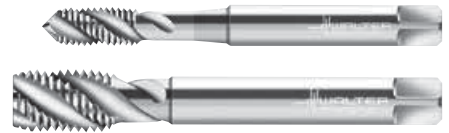

$\leq 3 \times D_N$

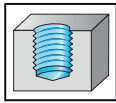

- HSS-E
- Chamfer form C = 2 - 3 thread
- 45° helix angle
- Materials from 200 to 1000 N/mm² or 32 HRC
- For long-chipping materials

EgUNF

NASM 33537

	P	M	K	N	S	H	O
uncoated	●●			●			●

DIN 2184-1 3B	D _N -P Nom	D _N mm	l ₁ js16 mm	L _c mm	l ₃ ±1 mm	d ₁ h9 mm	□ h12 mm	l _g mm	N	uncoated Designation P235099
	EG no. 6-40	4,33	70	8	25	6	4,9	8	3	★ -EGUNF6
	EG no. 8-36	5,083	80	10	30	6	4,9	8	3	★ -EGUNF8
	EG no. 10-32	5,857	80	10	30	6	4,9	8	3	★ -EGUNF10
	EG 1/4-28	7,528	90	12	35	8	6,2	9	3	★ -EGUNF1/4

DIN 2184-1 3B	D _N -P Nom	D _N mm	l ₁ js16 mm	L _c mm	l ₃ ±1 mm	d ₁ h9 mm	□ h12 mm	l _g mm	N	uncoated Designation P235599
	EG 5/16-24	9,313	90	12	-	7	5,5	8	3	★ -EGUNF5/16
	EG 3/8-24	10,9	90	15	-	8	6,2	9	3	★ -EGUNF3/8
	EG 7/16-20	12,763	100	13	-	9	7	10	4	★ -EGUNF7/16
	EG 1/2-20	14,35	100	15	-	11	9	12	4	★ -EGUNF1/2

★ New addition to range



Machine tap Paradur® X-pert M insert



$\leq 3 \times D_N$

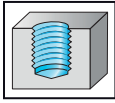

- HSS-E
- Chamfer form C = 2 - 3 thread
- 40° helix angle
- Materials from 350 to 1200 N/mm² or 36 HRC
- For long-chipping materials

EgUNF

NASM 33537

	P	M	K	N	S	H	O
vap	●	●●	■	■	■	■	■

DIN 2184-1 3B	D _N -P Nom	D _N mm	l ₁ js16 mm	L _c mm	l ₃ ±1 mm	d ₁ h9 mm	□ h12 mm	l _g mm	N	VAP Designation M235049
	EG no. 10-32	5,857	80	10	30	6	4,9	8	3	★ -EGUNF10
	EG 1/4-28	7,528	90	12	35	8	6,2	9	3	★ -EGUNF1/4

★ New addition to range



Machine tap Paradur® X-pert N insert



$\leq 3 \times D_N$

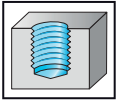

- HSS-E
- Chamfer form C = 2 - 3 thread
- 35° helix angle
- Materials from 200 to 700 N/mm² or 14 HRC
- For long-chipping materials

EgUNF

NASM 33537

	P	M	K	N	S	H	O
uncoated				●●	●		●

DIN 2184-1 3B	D _N -P Nom	D _N mm	l ₁ js16 mm	L _c mm	l ₃ ±1 mm	d ₁ h9 mm	□ h12 mm	l _g mm	N	uncoated Designation N235069
	EG no. 10-32	5,857	80	10	30	6	4,9	8	2	-EGUNF10
	EG 1/4-28	7,528	90	12	35	8	6,2	9	3	-EGUNF1/4

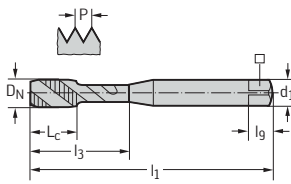

★ New addition to range



Walter Select – Thread forming

Blind and through hole machining

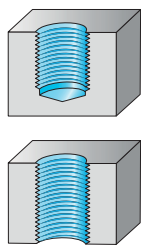

Solid carbide and HSS-E



BH = Blind hole
TH = Through hole











i = only for synchronous machining

Thread depth	2,0 x D _N	3,0 x D _N	
Type	Protodyn® Eco LM	Protodyn®	
Cutting tool material	HSS-E	Solid carbide	
	Page	Page	
M	<i>D 339*</i>	<i>D 349*</i>	
MJ			
MF		<i>D 358*</i>	
UNC	UNJC		
UNF	UNJF		
UNEF			
G			
RC	RP		
NPT	NPSM		
NPTF			
Pg	BSW		
TR			
EG M	EG MF		
EG UNC			
EG UNF			
Coating	CRN	TiCN	
Application	GL/DL	GL/DL	

Material group	Grouping of main material groups and code letters		Birmell hardness HB	Tensile strength R _m N/mm ²	Machining group			
	Workpiece material							
P	Non-alloyed and low-alloyed steel	annealed (tempered)	210	700	P1, P2, P3, P4, P7	●●	●●	
		free cutting steel	220	750	P6	●●	●●	
		tempered	300	1010	P5, P8		●●	
		tempered	380	1280	P9		●	
		tempered	430	1480	P10			
	High-alloyed steel and high-alloyed tool steel	annealed	200	670	P11		●●	
		hardened and tempered	300	1010	P12		●●	
		hardened and tempered	400	1360	P13			
	Stainless steel	ferritic/martensitic, annealed	200	670	P14			
		martensitic, tempered	330	1110	P15			
M	Stainless steel	austenitic, duplex	230	780	M1, M3			
		austenitic, precipitation hardened (PH)	300	1010	M2			
	Grey cast iron		245	–	K3, K4			
K	Cast iron with spheroidal graphite	ferritic, pearlitic	365	–	K1, K2, K5, K6			
	GGV (CGI)		200	–	K7			
N	Aluminium wrought alloys	cannot be hardened	30	–	N1	●●	●●	
		hardenable, hardened	100	340	N2	●●	●●	
	Cast aluminium alloys	≤ 12% Si	90	310	N3, N4	●●	●●	
		> 12% Si	130	450	N5			
	Magnesium alloys		70	250	N6			
	Copper and copper alloys (bronze/brass)	non-alloyed, electrolytic copper	100	340	N7	●●	●	
		brass, bronze, red brass	90	310	N8			
Cu-alloys, short-chipping		110	380	N9				
	high-strength, Ampco	300	1010	N10				
S	Heat-resistant alloys	Fe-based	280	940	S1, S2			
		Ni or Co base	250	840	S3		●●	
		Ni or Co base	350	1080	S4, S5			
	Titanium alloys	pure titanium	200	670	S6	●●		
		α and β alloys, hardened	375	1260	S7	●●		
	β alloys	410	1400	S8	●●			
	Tungsten alloys		300	1010	S9			
	Molybdenum alloys		300	1010	S10			
H	Hardened steel		50 HRC	–	H1			
			55 HRC	–	H2, H4			
			60 HRC	–	H3			
O	Thermoplasts	without abrasive fillers			O1			
	Thermosetting plastics	without abrasive fillers			O2			
	Plastic, fibre-reinforced	GFRP, AFRP			O3, O5			
		CFRP			O4			
	Graphite (technical)			65	O6			

* The pages indicated in italics refer to the Walter General catalogue 2012.

3,0 x D _N			3,5 x D _N								
Protodyn® Plus	Protodyn® Eco Plus	Protodyn® C	Protodyn® S HSC	Protodyn® S	Protodyn® S Plus	Protodyn® S Eco Plus	Protodyn® SC	Protodyn® SF	Protodyn® S Eco Inox	Protodyn® S Synchrospeed	
HSS-E	HSS-E	HSS-E	Solid carbide	HSS-E	HSS-E	HSS-E	HSS-E	HSS-E	HSS-E	HSS-E	
Page	Page	Page	Page	Page	Page	Page	Page	Page	Page	Page	
<i>D 342*</i>	<i>D 330*</i>	<i>D 319*</i>	D-130		<i>D 345*</i>	<i>D 333*</i>	<i>D 321*</i>	<i>D 323*</i>	<i>D 338*</i>	<i>D 340*</i>	
	<i>D 351*</i>		D-133	<i>D 357*</i>	<i>D 356*</i>	<i>D 352*</i>		<i>D 324*</i>		<i>D 355*</i>	
					<i>D 359*</i>						
					<i>D 360*</i>						
					<i>D 361*</i>			<i>D 325*</i>			
TiN	TiN/TiCN	uncoated/nid	TiCN	TiN	TiN	TiN/TiCN	uncoated/nid	TiCN	TiN	TiN/TiCN	
GL/DL	GL/DL	GL/DL	GL/DL	GL/DL	GL/DL	GL/DL	GL/DL	GL/DL	GL/DL	GL/DL	

			 NEW							 i
••	••	••	••	••	••	••	••	•	••	••
••	••	••	••	••	••	••	••	•	••	••
••	••	••	••	••	••	••	••	••	••	••
•	•	•	•	•	•	•	•	•	•	•
••	••	••	••	••	••	••	••	•	••	••
••	••	••	••	••	••	••	••	••	••	••
•	•	•	•	•	••	••	••	••	••	••
•	•	•	•	•	•	•	•	•	•	•
•	•	•	•	•	•	•	•	•	•	•
••	••	••	••	••	••	••	••	•	••	••
••	••	••	••	••	••	••	••	•	••	••
••	••	••	••	••	••	••	••	••	••	••
•	•	•	•	•	•	•	•	•	•	•
••	••	••	••	••	••	••	••	••	••	••

Machine thread former Protodyn® HSC



$\leq 3,5 \times D_N$

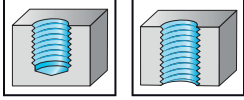

- VHM
- Chamfer form C = 2 - 3.5 thread
- Materials from 200 to 1200 N/mm² or 36 HRC
- For long-chipping materials

M

DIN 13

	P	M	K	N	S	H	O
TiCN	●●	●	●	●●	●		

DIN 2174 6HX		D_N	P mm	l_1 js16 mm	L_c mm	l_3 ± 1 mm	d_1 h6 mm	\square h12 mm	l_g mm	TiCN Designation HP8061106
	M 3	0,5	56	10	-	3,5	2,7	6	★ -M3	
	M 4	0,7	63	13	-	4,5	3,4	6	★ -M4	
	M 5	0,8	70	16	-	6	4,9	8	★ -M5	
	M 6	1	80	15	30	6	4,9	8	★ -M6	
	M 8	1,25	90	18	35	8	6,2	9	★ -M8	
	M 10	1,5	100	20	39	10	8	11	★ -M10	

★ New addition to range



Machine thread former Protodyn® S HSC



$\leq 3,5 \times D_N$

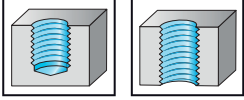

- VHM
- Chamfer form C = 2 - 3.5 thread
- Materials from 200 to 1200 N/mm² or 36 HRC
- For long-chipping materials

M

DIN 13

	P	M	K	N	S	H	O
TiCN	●●	●	●	●●	●		

DIN 2174 6HX		D_N	P mm	l_1 js16 mm	L_c mm	l_3 ± 1 mm	d_1 h6 mm	\square h12 mm	l_g mm	TiCN Designation HP8061716
	M 6		1	80	15	30	6	4,9	8	★ -M6
	M 8		1,25	90	18	35	8	6,2	9	★ -M8
	M 10		1,5	100	20	39	10	8	11	★ -M10

★ New addition to range



Machine thread former Protodyn® S HSC



$\leq 3,5 \times D_N$

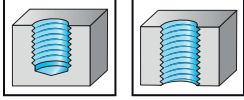

- VHM
- Chamfer form E = 1.5 - 2 thread
- Materials from 200 to 1200 N/mm² or 36 HRC
- For long-chipping materials

M

DIN 13

	P	M	K	N	S	H	O
TiCN	●●	●	●	●●	●		

DIN 2174 6HX		D_N	P mm	l_1 js16 mm	L_c mm	l_3 ± 1 mm	d_1 h6 mm	\square h12 mm	l_g mm	TiCN Designation HP8061816
	M 6	1	80	15	30	6	4,9	8	★ -M6	
	M 8	1,25	90	18	35	8	6,2	9	★ -M8	
	M 10	1,5	100	20	39	10	8	11	★ -M10	

★ New addition to range



Machine thread former Protodyn® S HSC



$\leq 3,5 \times D_N$

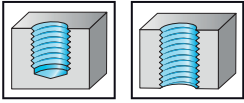

- VHM
- Chamfer form C = 2 - 3.5 thread
- Materials from 200 to 1200 N/mm² or 36 HRC
- For long-chipping materials

MF

DIN 13

	P	M	K	N	S	H	O
TiCN	●●	●	●	●●	●		

DIN 2174 6HX		D_N	P mm	l_1 js16 mm	L_c mm	d_1 h6 mm	\square h12 mm	l_g mm	TiCN Designation HP8166716
	M 8		1	90	12	6	4,9	8	★ -M8X1
	M 10		1	90	14	7	5,5	8	★ -M10X1
	M 12		1,5	100	21	9	7	10	★ -M12X1.5
	M 14		1,5	100	21	11	9	12	★ -M14X1.5
	M 16		1,5	100	21	12	9	12	★ -M16X1.5

★ New addition to range



Walter Select – Thread milling

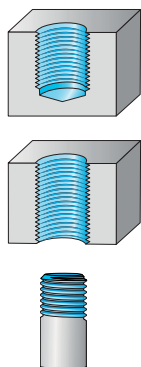

Blind and through hole machining

Solid carbide



BH = Blind hole
TH = Through hole

Thread depth		1,5 x D _N		
Type	Thread milling cutter - hard 10	Thread milling cutter 27	Thread milling cutter Ni 27	
Helix angle	10°	27°	27°	
	Page	Page	Page	
M	<i>D 370*</i>	<i>D 371*</i>		
MJ			<i>D 372*</i>	
MF	<i>D 370*</i>	<i>D 377*</i>		
UNC	UNJC			
UNF	UNJF		<i>D 381*</i>	
UNEF				
G				
RC	RP			
NPT	NPSM			
NPTF				
Pg	BSW			
TR				
EG M	EG MF			
EG UNC				
EG UNF				
Coolant	MQL/air blast	Emulsion/MQL	Emulsion/MQL	
Coating	TAX	TiCN	TiCN	
Shank	HA/HB	HA	HA	

Material group	Grouping of main material groups and code letters		Brinell hardness HB	Tensile strength R _m N/mm ²	Machining group				
	Workpiece material								
P	Non-alloyed and low-alloyed steel	annealed (tempered)	210	700	P1, P2, P3, P4, P7	●●	●		
		free cutting steel	220	750	P6	●●	●		
		tempered	300	1010	P5, P8	●●	●		
		tempered	380	1280	P9	●●	●		
		tempered	430	1480	P10	●●	●●	●	
	High-alloyed steel and high-alloyed tool steel	annealed	200	670	P11	●●	●●	●	
hardened and tempered		300	1010	P12	●●	●●	●		
hardened and tempered		400	1360	P13	●●	●●	●		
Stainless steel	ferritic/martensitic, annealed	200	670	P14	●	●●	●		
	martensitic, tempered	330	1110	P15	●	●●	●		
M	Stainless steel	austenitic, duplex	230	780	M1, M3	●●	●●	●	
		austenitic, precipitation hardened (PH)	300	1010	M2	●●	●●	●	
K	Grey cast iron		245	–	K3, K4	●●	●●	●	
	Cast iron with spheroidal graphite	ferritic, pearlitic	365	–	K1, K2, K5, K6	●●	●●	●	
	GGV (CGI)		200	–	K7	●●	●●	●	
N	Aluminium wrought alloys	cannot be hardened	30	–	N1	●●	●●	●	
		hardenable, hardened	100	340	N2	●●	●●	●	
	Cast aluminium alloys	≤ 12% Si	90	310	N3, N4	●●	●●	●	
		> 12% Si	130	450	N5	●●	●●	●	
	Magnesium alloys		70	250	N6	●●	●●	●	
	Copper and copper alloys (bronze/brass)	non-alloyed, electrolytic copper	100	340	N7	●●	●●	●	
brass, bronze, red brass		90	310	N8	●●	●●	●		
Cu-alloys, short-chipping		110	380	N9	●●	●●	●		
high-strength, Ampco		300	1010	N10	●●	●●	●		
S	Heat-resistant alloys	Fe-based	280	940	S1, S2	●●	●●	●●	
		Ni or Co base	250	840	S3	●●	●●	●●	
		Ni or Co base	350	1080	S4, S5	●●	●●	●●	
	Titanium alloys	pure titanium	200	670	S6	●●	●●	●●	
		α and β alloys, hardened	375	1260	S7	●●	●●	●●	
		β alloys	410	1400	S8	●●	●●	●●	
Tungsten alloys		300	1010	S9	●	●●	●		
Molybdenum alloys		300	1010	S10	●	●●	●		
H	Hardened steel		50 HRC	–	H1	●●			
			55 HRC	–	H2, H4	●●			
			60 HRC	–	H3	●●			
O	Thermoplasts	without abrasive fillers			O1	●●	●		
	Thermosetting plastics	without abrasive fillers			O2	●●	●		
	Plastic, fibre-reinforced	GFRP, AFRP				O3, O5	●	●	●
		CFRP				O4	●	●	●
	Graphite (technical)			65	O6	●	●	●	

* The pages indicated in italics refer to the Walter General catalogue 2012.

Orbital thread mill TMO



$\leq 2 \times D_N$

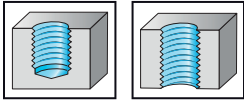

- VHM
- 3 to 5 cutting edges
- 15° helix angle
- Materials to 48 HRC

M-MF

DIN 13

	P	M	K	N	S	H	O
TiCN	●	●	●	●	●		●

Tool	P mm	D _c mm	L _c mm	l ₃ ±1 mm	d ₂ mm	l ₁ mm	l ₄ mm	d ₁ h6 mm	Z	TICN	
										Designation H5087016	
Shank DIN 6535HA	M 5	0,8	4	2,4	11,2	2,9	57	21	6	3	★ -M5
	M 6	1	4,8	3	13,5	3,4	57	21	6	3	★ -M6
	M 8	1,25	6,4	3,75	17,9	4,7	63	27	8	3	★ -M8
	M 10	1,5	8,2	4,5	22,3	6,16	72	32	10	4	★ -M10
	M 12	1,75	9,5	5,25	26,7	7,13	72	27	10	5	★ -M12

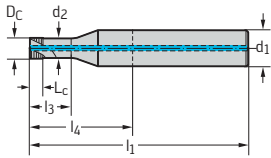

Orbital thread mill TMO



$\leq 3 \times D_N$

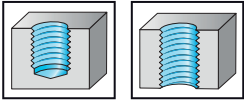

- VHM
- 3 cutting edges
- 15° helix angle
- Materials to 48 HRC

M-MF

DIN 13

	P	M	K	N	S	H	O
TiCN	●●	●●	●●	●●	●●		●

Tool	P mm	D _c mm	L _c mm	l ₃ ±1 mm	d ₂ mm	l ₁ mm	l ₄ mm	d ₁ h6 mm	Z	TiCN	
										Designation H5088016	
Shank DIN 6535HA	M 5	0,8	4	2,4	16,2	2,9	57	21	6	3	★ -M5
	M 6	1	4,8	3	19,5	3,4	60	24	6	3	★ -M6
	M 8	1,25	6,4	3,75	25,875	4,7	68	27	8	3	★ -M8

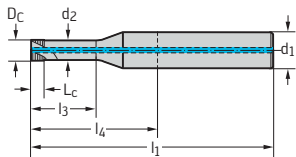

Orbital thread mill TMO



$\leq 2 \times D_N$

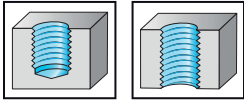

- VHM
- 3 cutting edges
- 15° helix angle
- Materials to 48 HRC

UNC

ASME B1.1

	P	M	K	N	S	H	O
TiCN	●	●	●	●	●		●

Tool	P Threads per inch	D _c mm	L _c mm	l ₃ ±1 mm	d ₂ mm	l ₁ mm	l ₄ mm	d ₁ h6 mm	Z	TiCN	
										Designation H5287006	
Shank DIN 6535HA	4-40 UNC	40	2,1	1,905	6,7	1,21	57	21	6	3	★ -UNC4
	6-32 UNC	32	2,6	2,382	8,3	1,5	57	21	6	3	★ -UNC6
	10-24 UNC	24	3,55	3,175	11,3	2,1	57	21	6	3	★ -UNC10

Tool	P Threads per inch	D _c mm	L _c mm	l ₃ ±1 mm	d ₂ mm	l ₁ mm	l ₄ mm	d ₁ h6 mm	Z	TiCN	
										Designation H5287016	
Shank DIN 6535HA	1/4-UNC	20	4,85	3,81	14,7	3,11	57	21	6	3	★ -UNC1/4
	5/16-UNC	18	6,2	4,233	18,1	4,28	63	27	8	3	★ -UNC5/16

★ New addition to range





Cutting data for thread tapping, thread forming, thread milling and drill thread milling

Material group	Grouping of main material groups and code letters		Brinell hardness HB	Tensile strength R_m N/mm ²	Machining group ¹	Taps					
						Solid carbide coated v_c [m/min]	HSS-E (-PM) uncoated v_c [m/min]	HSS-E (-PM) coated v_c [m/min]			
Workpiece material											
P	Non-alloyed steel	C ≤ 0.25%	annealed	125	428	P1		15	30	E	
		C > 0.25... ≤ 0.55%	annealed	190	639	P2		15	30	E	
		C > 0.25... ≤ 0.55%	tempered	210	708	P3		12,5	25	E	
		C > 0.55%	annealed	190	639	P4		15	30	E	
		C > 0.55%	tempered	300	1013	P5	45	7,5	15	E	
	free cutting steel (short-chipping)	annealed	220	745	P6		15	30	E		
	Low-alloyed steel		annealed	175	591	P7		15	30	E	
			tempered	300	1013	P8	50	7,5	15	E	
			tempered	380	1282	P9	35	4	7,5	E	
			tempered	430	1477	P10	20	2	4	O	
	High-alloyed steel and high-alloyed tool steel		annealed	200	675	P11		15	30	E	
			hardened and tempered	300	1013	P12	50	7,5	15	E	
			hardened and tempered	400	1361	P13	30	3	6	O	
	Stainless steel		ferritic/martensitic, annealed	200	675	P14		5	10	E	
			martensitic, tempered	330	1114	P15		2	4	E	
M	Stainless steel	austenitic, quench hardened		200	675	M1		5	10	E	
		austenitic, precipitation hardened (PH)		300	1013	M2		3	6	E	
		austenitic/ferritic, duplex		230	778	M3		4	8	E	
K	Malleable cast iron	ferritic		200	675	K1	40	15	30	E	
		pearlitic		260	867	K2	30	10	20	E	
	Grey cast iron	low tensile strength		180	602	K3	45	20	30	E	
		high tensile strength/austenitic		245	825	K4	30	7,5	15	E	
	Cast iron with spheroidal graphite	ferritic		155	518	K5	40	15	30	E	
		pearlitic		265	885	K6	30	10	20	E	
GGV (CGI)			200	675	K7	30	10	20	E		
N	Aluminium wrought alloys	cannot be hardened		30	–	N1		10	15	E	
		hardenable, hardened		100	343	N2		15	25	E	
	Cast aluminium alloys	≤ 12% Si, cannot be hardened		75	260	N3	50	15	20	E	
		≤ 12% Si, hardenable, hardened		90	314	N4	40	15	30	E	
		> 12% Si, cannot be hardened		130	447	N5	30	10	15	E	
	Magnesium alloys			70	250	N6	55	20	30	O	
	Copper and copper alloys (bronze/brass)	non-alloyed, electrolytic copper		100	343	N7		5	12,5	E	
		brass, bronze, red brass		90	314	N8	50	25	40	E	
		Cu-alloys, short-chipping		110	382	N9	40	20	35	E	
		high-strength, Ampco		300	1013	N10	12,5	2,5	5	E	
S	Heat-resistant alloys	Fe-based	annealed		200	675	S1		5	7,5	E
			hardened		280	943	S2		2,5	5	E
		Ni or Co base	annealed		250	839	S3		2,5	4	E
			hardened		350	1177	S4		1,5	2	O
			cast		320	1076	S5		2	3	O
	Titanium alloys	pure titanium		200	675	S6		7,5	7,5	E	
		α and β alloys, hardened		375	1262	S7		5	7,5	O	
		β alloys		410	1396	S8		2	3	O	
	Tungsten alloys			300	1013	S9	7,5	2,5	5	O	
	Molybdenum alloys			300	1013	S10	15	5	7,5	O	
H	Hardened steel	hardened and tempered		50 HRC	–	H1	15			O	
		hardened and tempered		55 HRC	–	H2	7,5			O	
		hardened and tempered		60 HRC	–	H3	5			O	
Hardened cast iron	hardened and tempered		55 HRC	–	H4	7,5			O		
O	Thermoplasts	without abrasive fillers				O1		20	20	E	
	Thermosetting plastics	without abrasive fillers				O2	25	10	10	E	
	Plastic, glass-fibre reinforced	GFRP				O3	15	2,5	5	E	
	Plastic, carbon-fibre reinforced	CFRP				O4	15	2,5	5	E	
	Plastic, aramid-fibre reinforced	AFRP				O5	15	2,5	5	E	
	Graphite (technical)			80 Shore			O6	20	15	15	E

¹ The classification of the machining groups can be found in the Walter General catalogue 2012 from page H 8 onwards.

Depending on application conditions, the optimum cutting data may differ from the table values by up to ± 25%.

= Cutting data for wet machining.

E = Emulsion

O = Oil

v_c = Cutting speed

The specified cutting data are average recommended values.
For special applications, adjustment is recommended.

	Thread formers				Thread milling cutter			Drill thread milling cutter
	Solid carbide coated	HSS-E (-PM) uncoated	HSS-E (-PM) coated		uncoated	coated	tooth feed matrix	drilling feed
	v_c [m/min]	v_c [m/min]	v_c [m/min]		v_c [m/min]	v_c [m/min]	f_z [mm]	f [mm/U]
		15	30	E		140	Table A	
		15	30	E		130	Table A	
		12,5	25	E		120	Table A	
		15	30	E		110	Table A	
	45	7,5	15	E		90	Table A	
		15	30	E		120	Table A	
		15	30	E		130	Table A	
	50	7,5	15	E		80	Table A	
						60	Table A	
						50	Table A	
		15	30	E		100	Table A	
	50	7,5	15	E		70	Table A	
						50	Table A	
		5	10	E O		45	Table A	
		2	4	O		30	Table A	
		5	10	E O		45	Table B	
		3	6	O		30	Table B	
		4	8	E O		35	Table B	
	40	15	30	E		100	Table A	Table D/row 3
						80	Table A	Table D/row 3
						120	Table A	Table D/row 3
						100	Table A	Table D/row 3
	40	15	30	E		100	Table A	Table D/row 3
						80	Table A	Table D/row 3
						70	Table A	Table D/row 1
		10	15	E	1000	1000	Table C	
		15	25	E	600	700	Table C	
	50	15	20	E	300	400	Table C	Table D/row 4
	40	15	30	E	200	250	Table C	Table D/row 4
					110	140	Table C	Table D/row 2
					250	400	Table C	
		5	12,5	E	180	280	Table C	Table D/row 4
	50	25	40	E	180	280	Table C	Table D/row 4
					180	280	Table C	Table D/row 4
					180	280	Table C	Table D/row 3
		5	7,5	E			Table B	
		2,5	5	E			Table B	
		2,5	4	O		40	Table B	
		1,5	2	O		20	Table B	
		2	3	O		30	Table B	
		7,5	7,5	E	70	90	Table A	
		5	7,5	O	40	50	Table A	
		2	3	O	30	35	Table A	
						40	Table B	
						40	Table B	
						50	Table B x 0.5	
						40	Table B x 0.5	
						30	Table B x 0.5	
						40	Table B x 0.5	
					120	220	Table C	Table D/row 4
					90	110	Table C	Table D/row 4
					30	45	Table C	Table D/row 3
					30	45	Table C	Table D/row 3
					30	45	Table C	Table D/row 3
						170	Table C	

Feed tables

A Material groups ISO P and ISO K, titanium alloys

a _e [mm]*	Feed per tooth f _z [mm]									
	Ø 2 mm	Ø 3 mm	Ø 4 mm	Ø 6 mm	Ø 8 mm	Ø 10 mm	Ø 12 mm	Ø 14 mm	Ø 16 mm	Ø 18 mm
0,01	0,06	0,09	0,12	0,15	0,15	0,20				
0,05	0,04	0,07	0,10	0,12	0,15	0,20				
0,1	0,035	0,05	0,08	0,10	0,15	0,20	0,20	0,20	0,20	
0,2	0,03	0,04	0,06	0,08	0,15	0,18	0,20	0,20	0,20	0,20
0,5	0,025	0,03	0,05	0,07	0,12	0,15	0,15	0,15	0,15	0,20
1	0,025	0,03	0,04	0,06	0,09	0,12	0,12	0,12	0,12	0,15
2	0,020	0,030	0,030	0,050	0,080	0,110	0,120	0,12	0,12	0,15

B Material groups ISO M and ISO H, heat-resistant alloys, tungsten alloys and molybdenum alloys

a _e [mm]*	Feed per tooth f _z [mm]									
	Ø 2 mm	Ø 3 mm	Ø 4 mm	Ø 6 mm	Ø 8 mm	Ø 10 mm	Ø 12 mm	Ø 14 mm	Ø 16 mm	Ø 18 mm
0,01	0,05	0,07	0,10	0,12	0,12	0,16				
0,05	0,03	0,06	0,08	0,10	0,12	0,16				
0,1	0,028	0,04	0,06	0,08	0,12	0,16	0,16	0,16	0,16	
0,2	0,02	0,03	0,05	0,06	0,12	0,14	0,16	0,16	0,16	0,16
0,5	0,020	0,02	0,04	0,06	0,10	0,12	0,12	0,12	0,12	0,16
1	0,020	0,02	0,03	0,05	0,07	0,10	0,10	0,10	0,10	0,12
2	0,016	0,024	0,024	0,040	0,064	0,088	0,096	0,10	0,10	0,12

C Material groups ISO N and ISO O

a _e [mm]*	Feed per tooth f _z [mm]									
	Ø 2 mm	Ø 3 mm	Ø 4 mm	Ø 6 mm	Ø 8 mm	Ø 10 mm	Ø 12 mm	Ø 14 mm	Ø 16 mm	Ø 18 mm
0,01	0,13	0,20	0,26	0,33	0,33	0,44				
0,05	0,09	0,15	0,22	0,26	0,33	0,44				
0,1	0,077	0,11	0,18	0,22	0,33	0,44	0,44	0,44	0,44	
0,2	0,07	0,09	0,13	0,18	0,33	0,40	0,44	0,44	0,44	0,44
0,5	0,055	0,07	0,11	0,15	0,26	0,33	0,33	0,33	0,33	0,44
1	0,055	0,07	0,09	0,13	0,20	0,26	0,26	0,26	0,26	0,33
2	0,044	0,066	0,066	0,110	0,176	0,242	0,264	0,26	0,26	0,33

D f / rev table

Line	Feed per revolution f [mm]				
	M6 Ø 5,0 mm	M8 Ø 6,75 mm	M10 Ø 8,5 mm	M12 Ø 10,25 mm	M16 Ø 14,0 mm
1	0,06	0,085	0,11	0,135	0,16
2	0,08	0,09	0,1	0,11	0,12
3	0,15	0,175	0,2	0,225	0,25
4	0,2	0,225	0,25	0,275	0,3

* Radial feed in mm.

The specified feed rates are average recommended values.

For specific applications, adjustment is recommended.

Coatings and surface treatments

nit	<p>Nitriding improves wear resistance by increasing surface hardness.</p>
vap	<p>Vaporisation/steam treatment improves the adhesion of the cooling lubricant to prevent cold welding. Application especially in stainless steels.</p>
nid	<p>Nitriding + steam treatment extends tool life in the machining of grey cast iron.</p>
TiN	<p>Titanium nitride is currently the most widely used and its application is practically universal. By comparison with other thin layers, does not always deliver the longest tool life. Due to its chemical affinity, TiN usually offers no benefits in the machining of titanium.</p>
TiN/ vap	<p>Titanium nitride + vaporised flutes significantly improve chip formation in comparison with fully TiN-coated tools, which, particularly in conjunction with high spiral blind hole taps, is important in the production of relatively deep threads not only in steels, but also in aluminium. The TiN/vap combination is used for Paradur® Synchrospeed and Paradur® Short Chip products as standard, as well as for a variety of special tools.</p>
TiCN	<p>Titanium carbon nitride is harder than TiN (approximately 3,000 HV to 2,300 HV), but has slightly less temperature resistance (approximately 400 to 600 °C). It is beneficial in the machining of abrasive materials. TiCN is particularly suitable for grey cast iron and AlSi alloys with an Si content higher than 5 %. Highly universal layer for thread milling.</p>
CRN	<p>Chromium nitride reduces weld formation in the case of Cu alloys and Al alloys in a similar way to hard chromium. However, it is approximately 650 HV harder and therefore has a higher wear resistance to more abrasive materials.</p>
TAFT	<p>Titanium aluminium nitride is used as part of a TAFT multilayer system on taps or, in the THL layer, as the base layer underneath the soft material layer of tungsten carbide/carbon (WC/C).</p>
ACN	<p>Aluminium chromium nitride is a titanium-free hard layer suitable not only for the machining of titanium alloys, but also for thread cutting and forming in cold extrusion steels.</p>
TAX	<p>Titanium aluminium nitride is used exclusively for thread milling. The TAX layer is used where a high degree of temperature resistance is required, e.g. in the machining of hardened steels.</p>
THL	<p>Hardlube is a tried-and-tested solution for dry machining or minimum quantity lubrication. It also delivers outstanding performance in the machining of stainless steels with emulsion. THL is generally compatible with almost any kind of steel material. Chip formation is improved in comparison with TiN and TiCN, which is an important advantage particularly in the machining of relatively deep blind holes in long-chipping materials.</p>
NHC	<p>New Hard Carbon is a carbon coating. It has a hardness of over 5,000 HV, which makes it comparable to diamond. This coating is used primarily for composite materials and non-ferrous metals and reduces both adhesion and abrasion.</p>



Milling

	Page	
Walter Prototyp milling cutters made from solid carbide, PCD and HSS	Walter Select – Milling	E-2
	Walter Select – Shoulder milling	E-6
	Walter Prototyp shoulder mills	E-12
	Walter Select – Shoulder/slot milling	E-14
	Walter Prototyp shoulder/slot mills	E-38
	Walter Select – Copy milling	E-60
	Walter Prototyp copy mills	E-70
	Walter Select – Profile milling	E-74
	Walter Prototyp profile mills	E-80
	Technical Information	Cutting data
Feed matrices		E-90
v_c correction factors		E-96
Cutting tool materials, surface treatments and coatings		E-97

Walter Select for milling

Step by step to the correct tool

STEP 1

Determine the **material** to be machined from page H 8 in the Walter General catalogue 2012

Note the machining group that corresponds to your material e.g.: P10.

Code letter	Machining group	Groups of the materials to be machined	
P	P1–P15	Steel	All types of steel and cast steel, with the exception of steel with an austenitic structure
M	M1–M3	Stainless steel	Stainless austenitic steel, austenitic-ferritic steel and cast steel
K	K1–K7	Cast iron	Grey cast iron, cast iron with spheroidal graphite, malleable cast iron, cast iron with vermicular graphite
N	N1–N10	NF metals	Aluminium and other non-ferrous metals, non-ferrous materials
S	S1–S10	High temperature alloys and titanium alloys	Heat resisting special alloys based on iron, nickel and cobalt, titanium and titanium alloys
H	H1–H4	Hard materials	Hardened steel, hardened cast iron materials, chilled cast iron
O	O1–O6	Other	Plastics, glass- and carbon-fibre reinforced plastics, graphite

STEP 2

Select the **machining conditions**:

Machine stability, clamping system and workpiece		
very good	good	moderate

STEP 3

Select your **machining method** based on the main categories and subcategories and then go to the relevant tool overview page.

Shoulder milling	
Shoulder milling without corner radius	Shoulder milling with corner radius
E-6	E-10

STEP 3
(continued)

Shoulder/slot milling

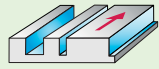

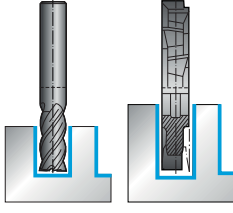
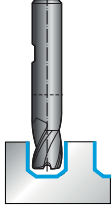
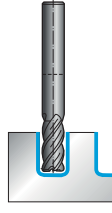
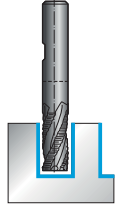
Shoulder/slot milling without corner radius	Shoulder/slot milling with chamfer	Shoulder/slot milling with corner radius	Shoulder/slot milling with roughing profile
			
E-14	E-22	E-25	E-33

Copy milling

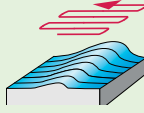
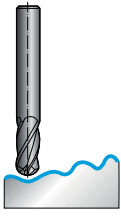
E-60

Profile milling

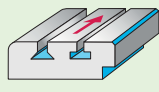

Chamfering and deburring	Corner rounding	T-slot milling	Dovetail milling
			
E-74	E-75	E-76	E-79

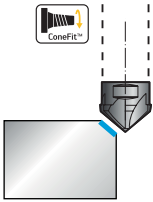
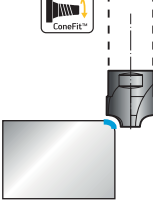
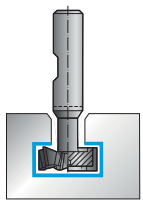
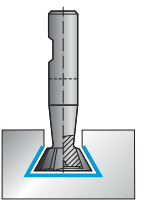
Walter Select for milling

Step by step to the correct tool

STEP 4

Select the appropriate tool for your **machining conditions** and then go to the ordering page.

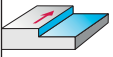

WALTER SELECT

Stability of the machine, clamping system and workpiece

● Main application

● Additional application

very good good moderate

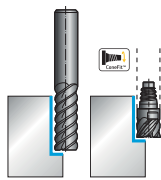

Solid carbide end mills

Machining conditions		Ø range		4 – 25	
Number of teeth		TAX		4 – 8	
Coating		Family		λ	
		ConeFit™		50°	
		N 50			
		N 45 long			
		H3023418		45°	
		H3123418		45°	
		H3023518		45°	
		H3123518		45°	

Material group	Grouping of main material groups and code letters	Workpiece material	Brinell hardness HB	Tensile strength R _m N/mm ²	Machining group	Ø 6 – 25	
						Z = 6 – 8	TAX
Non-alloyed and low-alloyed steel		annealed (tempered)	210	700	P1, P2, P3, P4, P7	●●	
		free cutting steel	220	750	P6	●●	
		tempered	300	1000		●●	
		tempered				●●	
		tempered				●●	

STEP 5

Based on the **material group** to be machined, look for the appropriate **cutting speed** by referring to **a_e** to **D_c** from page E-84 onwards and also the **feed group**.

Material group	Grouping of main material groups and code letters	Workpiece material	Brinell hardness HB	Tensile strength R _m N/mm ²	Machining group	Ø 6 – 25				
						Z = 6 – 8				
						TAX				
						1/2	1/4	1/10	VT	
P	Non-alloyed steel	C ≤ 0.25%	annealed	125	428	P1	240	290	A	
		C > 0.25% ≤ 0.55%	annealed	190	639	P2	230	280	A	
		C > 0.25% ≤ 0.55%	tempered	210	708	P3	200	240	A	
		C > 0.55%	annealed	190	639	P4	200	240	A	
		C > 0.55%	tempered	300	1013	P5	140	170	A	
	Low-alloyed steel	Free cutting steel (short-chipping)	annealed	220	745	P6	200	240	A	
		annealed	175	591	P7	200	240	A		
		tempered	300	1013	P8	140	170	A		
		tempered	380	1282	P9	120	140	A		
		tempered	430	1477	P10	100	120	A		
M	High-alloyed steel and high-alloyed tool steel	annealed	200	675	P11	200	240	A		
		hardened and tempered	300	1013	P12	140	170	A		
		hardened and tempered	400	1361	P13	100	120	A		
Stainless steel	ferritic/martensitic, annealed	200	675	P14	70	80	A			
	martensitic, tempered	330	1114	P15	50	60	A			
K	Malleable cast iron	austenitic, quench hardened	200	675	M1	80	100	B		
		austenitic, precipitation hardened (PH)	300	1013	M2	50	60	B		
		austenitic/ferritic, duplex	230	776	M3	70	80	B		
N	Aluminum wrought alloys	ferritic	200	675	K1					
		pearlitic	260	867	K2					
		Low tensile strength	180	602	K3					
		high tensile strength/austenitic	245	825	K4					
Cast iron with spheroidal graphite	ferritic	155	518	K5						
	pearlitic	265	885	K6						
	GGV (CGI)	200	675	K7						
N	Magnesium alloys	cannot be hardened	30	–	N1					
		hardenable, hardened	100	343	N2					
		≤ 12% Si, cannot be hardened	75	260	N3					
		≤ 12% Si, hardenable, hardened	90	314	N4					
		> 12% Si, cannot be hardened	130	447	N5					
Copper and copper alloys (bronze/brass)	non-alloyed, electrolytic copper	70	250	N6						
	brass, bronze, red brass	90	314	N8						
	Cu-alloys, short-chipping	110	382	N9						
	high strength, Amisco	300	1013	N10						

STEP 6

Based on the feed group, determine the correct **feed value** (page E-92) for your **operation conditions**.

D Protostar® Flash ISO-P, M, K, N, S, O											
Feed per tooth f _z [mm]											
a _e [mm]*	Ø 3 mm	Ø 4 mm	Ø 6 mm	Ø 8 mm	Ø 10 mm	Ø 12 mm	Ø 14 mm	Ø 16 mm	Ø 18 mm	Ø 20 mm	Ø 25 mm
0.8	0.07	0.10									
1.5	0.07	0.10	0.16	0.25							
3	0.07	0.10	0.16	0.25	0.30						
5		0.10	0.16	0.25	0.30	0.35					
6			0.16	0.25	0.30	0.35	0.40	0.50	0.60		
8				0.25	0.30	0.35	0.40	0.50	0.60	0.70	0.70
10					0.30	0.35	0.40	0.50	0.60	0.70	0.70
12							0.40	0.50	0.60	0.70	0.70
14							0.40	0.50	0.60	0.70	0.70
16								0.50	0.60	0.70	0.70
18									0.60	0.70	0.70
20										0.70	0.70
25											0.70

E Protostar® Flash ISO-H											
Feed per tooth f _z [mm]											
a _e [mm]*	Ø 3 mm	Ø 4 mm	Ø 6 mm	Ø 8 mm	Ø 10 mm	Ø 12 mm	Ø 14 mm	Ø 16 mm	Ø 18 mm	Ø 20 mm	Ø 25 mm
0.8	0.06	0.08									
1.5	0.06	0.08	0.13	0.20							
3	0.06	0.08	0.13	0.20	0.25						
5		0.08	0.13	0.20	0.25	0.30					
6			0.13	0.20	0.25	0.30	0.40	0.50	0.60		
8				0.20	0.25	0.30	0.40	0.50	0.60	0.70	0.70
10					0.25	0.30	0.40	0.50	0.60	0.70	0.70
12							0.40	0.50	0.60	0.70	0.70
14							0.40	0.50	0.60	0.70	0.70
16								0.50	0.60	0.70	0.70
18									0.60	0.70	0.70
20										0.70	0.70
25											0.70



Walter Select – Shoulder milling without corner radius

Solid carbide shank cutters

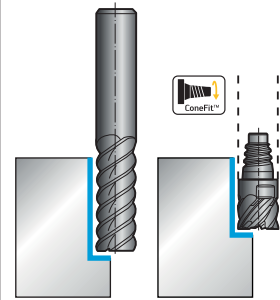
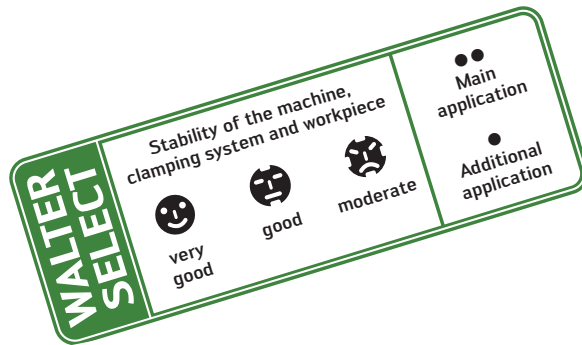
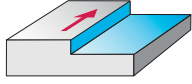

Solid carbide end mills

Machining conditions	☹			
Ø range	4 – 25			
Number of teeth	4 – 8			
Coating	TAX			
	Family	Designation	λ	Page

Material group	Grouping of main material groups and code letters		Brinell hardness HB	Tensile strength R _m N/mm ²	Machining group	ConeFit™			
	Workpiece material					Family	Designation	λ	Page
P	Non-alloyed and low-alloyed steel	annealed (tempered)	210	700	P1, P2, P3, P4, P7	ConeFit™ N 50	H3E21138	50°	<i>E 37*</i>
		free cutting steel	220	750	P6				
		tempered	300	1010	P5, P8				
		tempered	380	1280	P9				
		tempered	430	1480	P10				
	High-alloyed steel and high-alloyed tool steel	annealed	200	670	P11	N 45 long	H3023418	45°	<i>E 40*</i>
		hardened and tempered	300	1010	P12				
		hardened and tempered	400	1360	P13				
	Stainless steel	ferritic/martensitic, annealed	200	670	P14	H3123418	45°	<i>E 40*</i>	
		martensitic, tempered	330	1110	P15				
M	Stainless steel	austenitic, duplex	230	780	M1, M3	H3023518	45°	<i>E 41*</i>	
		austenitic, precipitation hardened (PH)	300	1010	M2				
K	Grey cast iron		245	–	K3, K4	H3123518	45°	<i>E 41*</i>	
	Cast iron with spheroidal graphite	ferritic, pearlitic	365	–	K1, K2, K5, K6				
	GGV (CGI)		200	–	K7				
N	Aluminium wrought alloys	cannot be hardened	30	–	N1	N 45 long	H3123518	45°	<i>E 41*</i>
		hardenable, hardened	100	340	N2				
	Cast aluminium alloys	≤ 12% Si	90	310	N3, N4				
		> 12% Si	130	450	N5				
	Magnesium alloys		70	250	N6				
	Copper and copper alloys (bronze/brass)	non-alloyed, electrolytic copper	100	340	N7				
brass, bronze, red brass		90	310	N8					
Cu-alloys, short-chipping		110	380	N9					
high-strength, Ampco		300	1010	N10					
S	Heat-resistant alloys	Fe-based	280	940	S1, S2	N 45 long	H3123518	45°	<i>E 41*</i>
		Ni or Co base	250	840	S3				
		Ni or Co base	350	1080	S4, S5				
	Titanium alloys	pure titanium	200	670	S6				
		α and β alloys, hardened	375	1260	S7				
		β alloys	410	1400	S8				
	Tungsten alloys		300	1010	S9				
Molybdenum alloys		300	1010	S10					
H	Hardened steel		50 HRC	–	H1	N 45 long	H3123518	45°	<i>E 41*</i>
			55 HRC	–	H2, H4				
			60 HRC	–	H3				
O	Thermoplasts	without abrasive fillers			O1	N 45 long	H3123518	45°	<i>E 41*</i>
	Thermosetting plastics	without abrasive fillers			O2				
	Plastic, fibre-reinforced	GFRP, AFRP			O3, O5				
		CFRP			O4				
Graphite (technical)			65		O6				

* The pages indicated in italics refer to the Walter General catalogue 2012.

Walter Select – Shoulder milling without corner radius PCD end mill

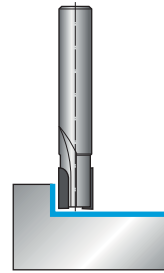
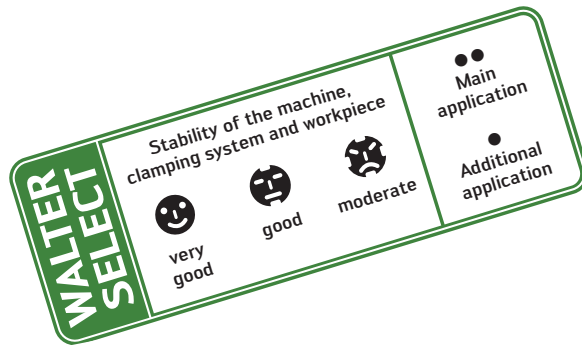
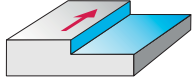

PCD end mill

Material group		Grouping of main material groups and code letters	Workpiece material	Brinell hardness HB	Tensile strength R _m N/mm ²	Machining group	Machining conditions			
							Family	Designation	λ	Page
							☺			
							Ø range 6 – 20			
							Number of teeth 2			
							Coating PCD			
							PCD shoulder mills	F4722	0°	E 52*
P	Non-alloyed and low-alloyed steel	annealed (tempered)	210	700	P1, P2, P3, P4, P7					
		free cutting steel	220	750	P6					
		tempered	300	1010	P5, P8					
		tempered	380	1280	P9					
		tempered	430	1480	P10					
	High-alloyed steel and high-alloyed tool steel	annealed	200	670	P11					
		hardened and tempered	300	1010	P12					
		hardened and tempered	400	1360	P13					
	Stainless steel	ferritic/martensitic, annealed	200	670	P14					
		martensitic, tempered	330	1110	P15					
M	Stainless steel	austenitic, duplex	230	780	M1, M3					
		austenitic, precipitation hardened (PH)	300	1010	M2					
K	Grey cast iron		245	–	K3, K4					
	Cast iron with spheroidal graphite	ferritic, pearlitic	365	–	K1, K2, K5, K6					
	GGV (CGI)		200	–	K7					
N	Aluminium wrought alloys	cannot be hardened	30	–	N1	●●				
		hardenable, hardened	100	340	N2	●●				
	Cast aluminium alloys	≤ 12% Si	90	310	N3, N4	●●				
		> 12% Si	130	450	N5	●●				
	Magnesium alloys		70	250	N6	●●				
S	Heat-resistant alloys	non-alloyed, electrolytic copper	100	340	N7	●●				
		brass, bronze, red brass	90	310	N8	●●				
		Cu-alloys, short-chipping	110	380	N9	●●				
		high-strength, Ampco	300	1010	N10	●●				
	Titanium alloys	pure titanium	200	670	S6					
		α and β alloys, hardened	375	1260	S7					
		β alloys	410	1400	S8					
	Tungsten alloys		300	1010	S9					
	Molybdenum alloys		300	1010	S10					
H	Hardened steel		50 HRC	–	H1					
			55 HRC	–	H2, H4					
			60 HRC	–	H3					
O	Thermoplasts	without abrasive fillers			O1					
	Thermosetting plastics	without abrasive fillers			O2					
	Plastic, fibre-reinforced	GFRP, AFRP			O3, O5					
		CFRP			O4					
	Graphite (technical)			65	O6					

* The pages indicated in italics refer to the Walter General catalogue 2012.

Walter Select – Shoulder milling with facet Helical milling cutters, porcupine cutters, PCD end mills

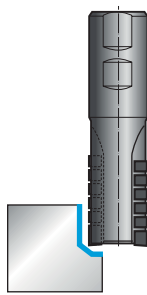
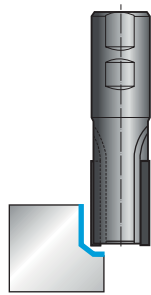

Brazed end mills



PCD end mill

☺				☺				☺				☺			
16 – 100				16 – 100				20 – 40				50 – 125			
3 – 8				1 – 4				4 + 5				5 – 8			
uncoated				uncoated				PCD				PCD			
Family	Designation	λ	Page	Family	Designation	λ	Page	Family	Designation	λ	Page	Family	Designation	λ	Page
Helical milling cutters	F1675		E 53*	Porcupine cutter	F1375	0°	E 53*	PCD shoulder mills	F4722	0°	E 52*	PCD face milling cutters	F4723	0°	E 56*
	F1676		E 55*		F1605		E 53*								
	F1677		E 54*		F1616		E 53*								
	F1678		E 54*												
	F1682		E 54*												
	••			••											
	••			••											
	••			••											
	••			••											
	••			••											
	••			••											
	••			••											
	••			••											
	••			••											
	••			••											
	••			••											
	••			••											
	••			••											
	••			••											
	••			••											
	••			••											
	••			••											

Walter Select – Shoulder milling with corner radius

Solid carbide shank cutters

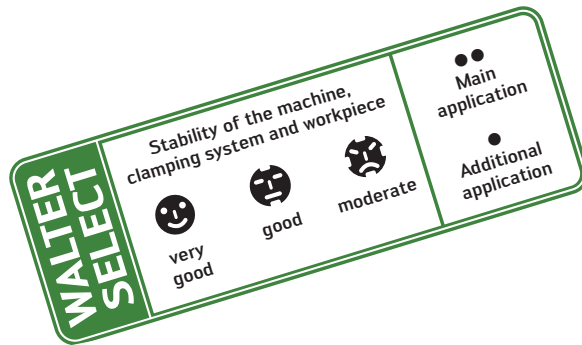
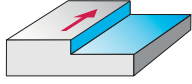

Solid carbide end mills

Material group	Grouping of main material groups and code letters	Workpiece material	Brinell hardness HB	Tensile strength R_m N/mm ²	Machining group	Machining conditions			
						Ø range 10 – 25 Number of teeth 6 – 8 Coating TAX Family Designation λ Page			
						ConeFit™ N 50	H3E23138	50°	E-12
						N 50	H3023138	50°	E-13
P	Non-alloyed and low-alloyed steel	annealed (tempered)	210	700	P1, P2, P3, P4, P7	●●			
		free cutting steel	220	750	P6	●●			
		tempered	300	1010	P5, P8	●●			
		tempered	380	1280	P9	●●			
		tempered	430	1480	P10	●●			
	High-alloyed steel and high-alloyed tool steel	annealed	200	670	P11	●●			
hardened and tempered		300	1010	P12	●●				
hardened and tempered		400	1360	P13	●●				
Stainless steel	ferritic/martensitic, annealed	200	670	P14	●●				
	martensitic, tempered	330	1110	P15	●●				
M	Stainless steel	austenitic, duplex	230	780	M1, M3	●			
		austenitic, precipitation hardened (PH)	300	1010	M2	●			
K	Grey cast iron		245	–	K3, K4				
	Cast iron with spheroidal graphite	ferritic, pearlitic	365	–	K1, K2, K5, K6				
	GGV (CGI)		200	–	K7				
N	Aluminium wrought alloys	cannot be hardened	30	–	N1				
		hardenable, hardened	100	340	N2				
	Cast aluminium alloys	≤ 12% Si	90	310	N3, N4				
		> 12% Si	130	450	N5				
	Magnesium alloys		70	250	N6				
	Copper and copper alloys (bronze/brass)	non-alloyed, electrolytic copper		100	340	N7			
brass, bronze, red brass			90	310	N8				
Cu-alloys, short-chipping			110	380	N9				
high-strength, Ampco			300	1010	N10				
S	Heat-resistant alloys	Fe-based	280	940	S1, S2				
		Ni or Co base	250	840	S3				
		Ni or Co base	350	1080	S4, S5				
	Titanium alloys	pure titanium	200	670	S6				
		α and β alloys, hardened	375	1260	S7				
		β alloys	410	1400	S8				
Tungsten alloys		300	1010	S9					
Molybdenum alloys		300	1010	S10					
H	Hardened steel		50 HRC	–	H1				
			55 HRC	–	H2, H4				
			60 HRC	–	H3				
O	Thermoplasts	without abrasive fillers			O1				
	Thermosetting plastics	without abrasive fillers			O2				
	Plastic, fibre-reinforced	GFRP, AFRP			O3, O5				
		CFRP			O4				
Graphite (technical)			65	O6					

* The pages indicated in italics refer to the Walter General catalogue 2012.

End mills with corner radius Protostar® N 50



Materials to 48 HRC

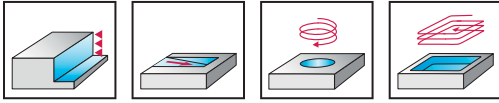

- VHM
- 6 to 8 cutting edges
- Without centre cut
- 50° helix angle

Special features:

Slot milling: $a_p \leq 0.1 \times D_c$

Shoulder milling: $a_e \leq 0.1 \times D_c$

	P	M	K	N	S	H	O
TAX	●●	●	●	●	●	●	●

P standard	D_c h9 mm	R mm	L_c mm	d_2 mm	l_1 mm	l_4 mm	SW mm	d_1	Z	TAX Designation H3E23138
	10	0,5	5,5	9,7	23,6	12,4	8	E10	6	-E10-10-0.5
	10	1	5,5	9,7	23,6	12,4	8	E10	6	-E10-10-1
	12	0,5	6,5	11,7	28,3	14,5	10	E12	6	-E12-12-0.5
	12	1	6,5	11,7	28,3	14,5	10	E12	6	-E12-12-1
	12	1,5	6,5	11,7	28,3	14,5	10	E12	6	-E12-12-1.5
	12	2	6,5	11,7	28,3	14,5	10	E12	6	★ -E12-12-2
	16	0,5	8,5	15,5	35,7	18,7	12	E16	6	-E16-16-0.5
	16	1	8,5	15,5	35,7	18,7	12	E16	6	-E16-16-1
	16	1,5	8,5	15,5	35,7	18,7	12	E16	6	-E16-16-1.5
	16	2	8,5	15,5	35,7	18,7	12	E16	6	-E16-16-2
	20	1	11	19,3	40,8	21,3	16	E20	8	-E20-20-1
	20	1,5	11	19,3	40,8	21,3	16	E20	8	-E20-20-1.5
	20	2	11	19,3	40,8	21,3	16	E20	8	-E20-20-2
	20	4	11	19,3	40,8	21,3	16	E20	8	-E20-20-4
	25	1	13,5	24,2	49,6	25,6	20	E25	8	-E25-25-1
	25	2	13,5	24,2	49,6	25,6	20	E25	8	-E25-25-2
	25	4	13,5	24,2	49,6	25,6	20	E25	8	-E25-25-4

★ New addition to range

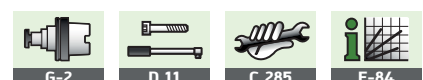

End mills with corner radius Protostar® N 50



Materials to 48 HRC

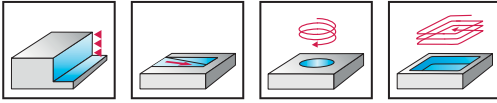

- VHM
- 6 to 8 cutting edges
- Without centre cut
- 50° helix angle

Special features:

Slot milling: $a_p \leq 0.1 \times D_c$

Shoulder milling: $a_e \leq 0.1 \times D_c$

	P	M	K	N	S	H	O
TAX	●●	●	●	●	●	●	●

DIN 6527 L	D_c h9 mm	R mm	L_c mm	l_1 mm	l_4 mm	d_1 mm	Z	TAX Designation H3023138
Shank DIN 6535 HA	6	0,5	13	57	21	6	6	★ -6-0.5
	8	0,5	19	63	27	8	6	★ -8-0.5
	8	1	19	63	27	8	6	★ -8-1
	10	0,5	22	72	32	10	6	★ -10-0.5
	10	1	22	72	32	10	6	★ -10-1
	10	1,5	22	72	32	10	6	★ -10-1.5
	10	2	22	72	32	10	6	★ -10-2
	12	0,5	26	83	38	12	6	★ -12-0.5
	12	1	26	83	38	12	6	★ -12-1
	12	1,5	26	83	38	12	6	★ -12-1.5
	12	2	26	83	38	12	6	★ -12-2
	12	3	26	83	38	12	6	★ -12-3
	16	0,5	32	92	44	16	6	★ -16-0.5
	16	1	32	92	44	16	6	★ -16-1
	16	2	32	92	44	16	6	★ -16-2
	16	3	32	92	44	16	6	★ -16-3
	16	4	32	92	44	16	6	★ -16-4
	20	1	38	104	54	20	8	★ -20-1
	20	2	38	104	54	20	8	★ -20-2
	20	3	38	104	54	20	8	★ -20-3
	20	4	38	104	54	20	8	★ -20-4
	25	1	45	121	65	25	8	★ -25-1
	25	2	45	121	65	25	8	★ -25-2
	25	4	45	121	65	25	8	★ -25-4

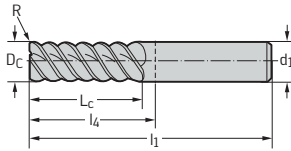

★ New addition to range

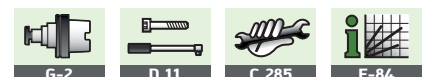

Walter Select – Shoulder/slot milling without corner radius

Solid carbide shank cutters

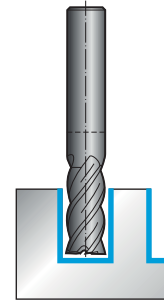
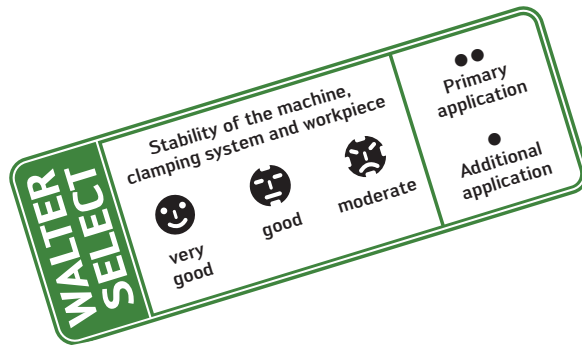
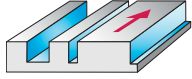

Solid carbide end mills

Material group		Grouping of main material groups and code letters	Workpiece material	Brinell hardness HB	Tensile strength R_m N/mm ²	Machining group	Machining conditions			
							Family	Designation	λ	Page
							Ø range 2 – 20 NEW			
							Number of teeth 3 + 4			
							Coating TAZ			
							ConeFit™ H4E34217 50° E-38 Proto-max™ _{ST} Proto-max™ _{ST} H4034217 50° E-39 H4134217 E-39 H4033217 45° E-40 H4133217 E-40			
P	Non-alloyed and low-alloyed steel	annealed (tempered)	210	700	P1, P2, P3, P4, P7	●●				
		free cutting steel	220	750	P6	●●				
		tempered	300	1010	P5, P8	●●				
		tempered	380	1280	P9	●●				
		tempered	430	1480	P10	●●				
	High-alloyed steel and high-alloyed tool steel	annealed	200	670	P11	●●				
		hardened and tempered	300	1010	P12	●●				
		hardened and tempered	400	1360	P13	●●				
	Stainless steel	ferritic/martensitic, annealed	200	670	P14	●●				
		martensitic, tempered	330	1110	P15	●●				
M	Stainless steel	austenitic, duplex	230	780	M1, M3	●				
		austenitic, precipitation hardened (PH)	300	1010	M2	●				
K	Grey cast iron		245	–	K3, K4					
	Cast iron with spheroidal graphite	ferritic, pearlitic	365	–	K1, K2, K5, K6					
	GGV (CGI)		200	–	K7					
N	Aluminium wrought alloys	cannot be hardened	30	–	N1					
		hardenable, hardened	100	340	N2					
	Cast aluminium alloys	≤ 12% Si	90	310	N3, N4					
		> 12% Si	130	450	N5					
	Magnesium alloys		70	250	N6					
S	Copper and copper alloys (bronze/brass)	non-alloyed, electrolytic copper	100	340	N7					
		brass, bronze, red brass	90	310	N8					
		Cu-alloys, short-chipping	110	380	N9					
		high-strength, Ampco	300	1010	N10					
S	Heat-resistant alloys	Fe-based	280	940	S1, S2					
		Ni or Co base	250	840	S3					
		Ni or Co base	350	1080	S4, S5					
	Titanium alloys	pure titanium	200	670	S6					
		α and β alloys, hardened	375	1260	S7					
		β alloys	410	1400	S8					
Tungsten alloys		300	1010	S9						
Molybdenum alloys		300	1010	S10						
H	Hardened steel		50 HRC	–	H1					
			55 HRC	–	H2, H4					
			60 HRC	–	H3					
O	Thermoplasts	without abrasive fillers			O1					
	Thermosetting plastics	without abrasive fillers			O2					
	Plastic, fibre-reinforced	GFRP, AFRP			O3, O5					
		CFRP			O4					
	Graphite (technical)			65	O6					

* The pages indicated in italics refer to the Walter General catalogue 2012.

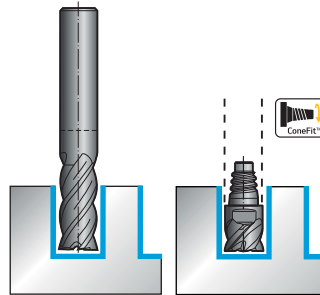

Solid carbide end mills

☺					☹				☹				☹					
6 – 25					2 – 25				2 – 25				2 – 20					
4 – 5					3 – 5				3 – 5				3 – 4					
TAA					TAX				TAT				TAX					
Family	Designation	λ	Page		Family	Designation	λ	Page		Family	Designation	λ	Page		Family	Designation	λ	Page
ConeFit™	H2EC34217	50°	E-41		ConeFit™	H3E21317	50°	E 85*		Proto-max™TG	H3021178	50°	E-43		Tough	H3071118	50°	E 90*
Proto-max™					Tough						H3021378	50°	E-44		Guys H 50	H3071318	50°	E 90*
Inox					Guys N 50						H3121378	50°	E-44		(48–63 HRC)	H3171318	50°	E 90*
											H4121078	50°	E-45					
Proto-max™	H2034217	35°/38°	E-42		Tough	H3021117	50°	E 84*			H4121178	50°	E-46					
Inox	H2134217		E-42		Guys N 50	H3021317	50°	E 86*			H4121278	50°	E-47					
						H3121317	50°	E 86*										
						H4021017	50°	E 87*										
						H4121017	50°	E 87*										
						H4021117	50°	E 88*										
						H4121117	50°	E 88*										
						H4021217	50°	E 89*										
						H4121217	50°	E 89*										

Walter Select – Shoulder/slot milling without corner radius

Solid carbide shank cutters

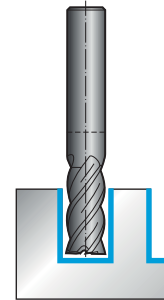
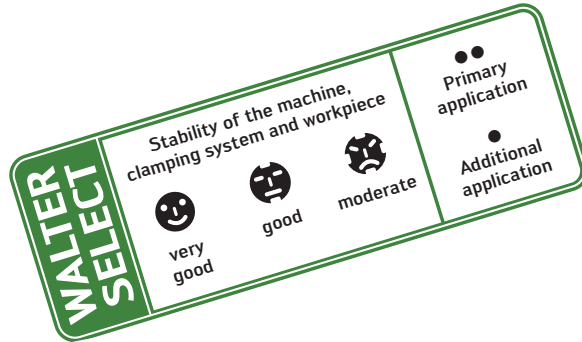
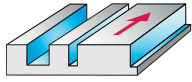

Solid carbide end mills

Material group	Grouping of main material groups and code letters	Workpiece material	Brinell hardness HB	Tensile strength R_m N/mm ²	Machining group	Machining conditions			
						Family	Designation	λ	Page
						Machining conditions: 1 – 25 Ø range: 2 – 3 Number of teeth: TAX Coating: TAX			
						ConeFit™ N 45	H3E29148	45°	<i>E 94*</i>
						45	H3029148 H3129148	45° 45°	<i>E 94*</i> <i>E 95*</i>
						30	H3026118 H3027118 H3027318 H3027418	30° 30° 30° 30°	<i>E 100*</i> <i>E 101*</i> <i>E 102*</i> <i>E 103*</i>
P	Non-alloyed and low-alloyed steel	annealed (tempered)	210	700	P1, P2, P3, P4, P7	••			
		free cutting steel	220	750	P6	••			
		tempered	300	1010	P5, P8	••			
		tempered	380	1280	P9	••			
		tempered	430	1480	P10	••			
	High-alloyed steel and high-alloyed tool steel	annealed	200	670	P11	••			
		hardened and tempered	300	1010	P12	••			
		hardened and tempered	400	1360	P13	••			
	Stainless steel	ferritic/martensitic, annealed	200	670	P14	••			
		martensitic, tempered	330	1110	P15	••			
M	Stainless steel	austenitic, duplex	230	780	M1, M3				
		austenitic, precipitation hardened (PH)	300	1010	M2				
K	Grey cast iron		245	–	K3, K4	•			
	Cast iron with spheroidal graphite	ferritic, pearlitic	365	–	K1, K2, K5, K6	•			
	GGV (CGI)		200	–	K7	•			
N	Aluminium wrought alloys	cannot be hardened	30	–	N1				
		hardenable, hardened	100	340	N2				
	Cast aluminium alloys	≤ 12% Si	90	310	N3, N4				
		> 12% Si	130	450	N5				
	Magnesium alloys		70	250	N6				
	Copper and copper alloys (bronze/brass)	non-alloyed, electrolytic copper	100	340	N7				
		brass, bronze, red brass	90	310	N8				
		Cu-alloys, short-chipping	110	380	N9				
		high-strength, Ampco	300	1010	N10				
S	Heat-resistant alloys	Fe-based	280	940	S1, S2				
		Ni or Co base	250	840	S3				
		Ni or Co base	350	1080	S4, S5				
	Titanium alloys	pure titanium	200	670	S6				
		α and β alloys, hardened	375	1260	S7				
		β alloys	410	1400	S8				
	Tungsten alloys		300	1010	S9				
	Molybdenum alloys		300	1010	S10				
H	Hardened steel		50 HRC	–	H1				
			55 HRC	–	H2, H4				
			60 HRC	–	H3				
O	Thermoplasts	without abrasive fillers			O1				
	Thermosetting plastics	without abrasive fillers			O2				
	Plastic, fibre-reinforced	GFRP, AFRP			O3, O5				
		CFRP			O4				
	Graphite (technical)			65	O6				

* The pages indicated in italics refer to the Walter General catalogue 2012.

Walter Select – Shoulder/slot milling without corner radius

Solid carbide shank cutters

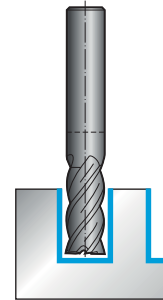
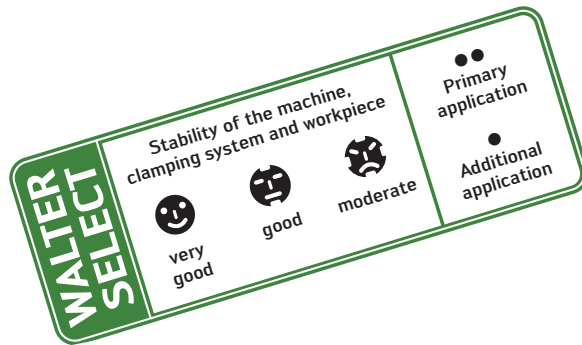
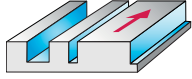

Solid carbide end mills

Material group	Grouping of main material groups and code letters	Workpiece material	Brinell hardness HB	Tensile strength R_m N/mm ²	Machining group	Machining conditions			
						Family	Designation	λ	Page
						Ø range 1 – 16 Number of teeth 3 Coating DIA			
						30	H3027419	30°	<i>E 104*</i>
P	Non-alloyed and low-alloyed steel	annealed (tempered)	210	700	P1, P2, P3, P4, P7				
		free cutting steel	220	750	P6				
		tempered	300	1010	P5, P8				
		tempered	380	1280	P9				
		tempered	430	1480	P10				
	High-alloyed steel and high-alloyed tool steel	annealed	200	670	P11				
		hardened and tempered	300	1010	P12				
		hardened and tempered	400	1360	P13				
	Stainless steel	ferritic/martensitic, annealed	200	670	P14				
		martensitic, tempered	330	1110	P15				
M	Stainless steel	austenitic, duplex	230	780	M1, M3				
		austenitic, precipitation hardened (PH)	300	1010	M2				
K	Grey cast iron		245	–	K3, K4				
	Cast iron with spheroidal graphite	ferritic, pearlitic	365	–	K1, K2, K5, K6				
	GGV (CGI)		200	–	K7				
N	Aluminium wrought alloys	cannot be hardened	30	–	N1				
		hardenable, hardened	100	340	N2				
	Cast aluminium alloys	≤ 12% Si	90	310	N3, N4				
		> 12% Si	130	450	N5				
	Magnesium alloys		70	250	N6				
	Copper and copper alloys (bronze/brass)	non-alloyed, electrolytic copper	100	340	N7				
		brass, bronze, red brass	90	310	N8				
		Cu-alloys, short-chipping	110	380	N9				
		high-strength, Ampco	300	1010	N10				
S	Heat-resistant alloys	Fe-based	280	940	S1, S2				
		Ni or Co base	250	840	S3				
		Ni or Co base	350	1080	S4, S5				
	Titanium alloys	pure titanium	200	670	S6				
		α and β alloys, hardened	375	1260	S7				
		β alloys	410	1400	S8				
	Tungsten alloys		300	1010	S9				
	Molybdenum alloys		300	1010	S10				
H	Hardened steel		50 HRC	–	H1				
			55 HRC	–	H2, H4				
			60 HRC	–	H3				
O	Thermoplasts	without abrasive fillers			O1				
	Thermosetting plastics	without abrasive fillers			O2				
	Plastic, fibre-reinforced	GFRP, AFRP			O3, O5				
		CFRP			O4				
	Graphite (technical)			65	O6				

* The pages indicated in italics refer to the Walter General catalogue 2012.

Walter Select – Shoulder/slot milling without corner radius HSS end mills

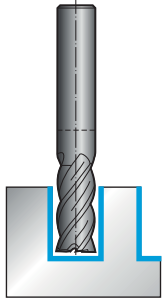

Solid carbide end mills

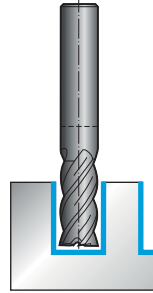

HSS end mills

☺				☹				☹				☹			
2 – 20				3 – 25				2 – 50				1 – 32			
2				3 – 8				2 – 8				2 – 8			
uncoated				ACN				uncoated				ACN			
Family	Designation	λ	Page	Family	Designation	λ	Page	Family	Designation	λ	Page	Family	Designation	λ	Page
AL 25	H602641	25°	E 107*	N 45	P3123117	45°	E 108*	W 40	P312411	40°	E 109*	N 45	P3123017	45°	E 108*
	H602681	25°	E 107*						P312401	40°	E 109*				
				N 30	P3122117	30°	E 118*					N 30	P3122017	30°	E 116*
					P3122317	30°	E 120*	AL 40	P602612	40°	E 112*				
									P612612	40°	E 112*				
									P602602	40°	E 111*	30	P3106117	30°	E 113*
									P612602	40°	E 111*		P3116127	30°	E 115*
								AL 25	P632612	25°	E 125*		P3117127	30°	E 122*

Walter Select – Shoulder/slot milling without corner radius HSS end mills

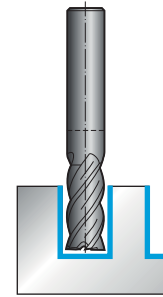
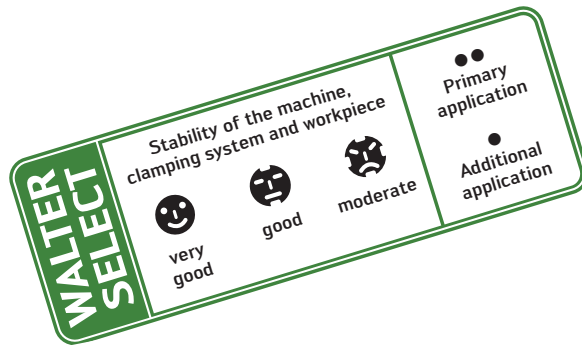
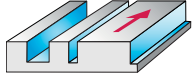

HSS end mills

Material group		Grouping of main material groups and code letters	Workpiece material	Brinell hardness HB	Tensile strength R_m N/mm ²	Machining group	Machining conditions			
							Family	Designation	λ	Page
Machining conditions										
\emptyset range							1 – 50			
Number of teeth							2 – 8			
Coating							uncoated			
							N 45	P312301	45°	<i>E 108*</i>
							N 30	P302211	30°	<i>E 118*</i>
								P312211	30°	<i>E 118*</i>
								P312221	30°	<i>E 120*</i>
								P302201	30°	<i>E 116*</i>
								P312201	30°	<i>E 116*</i>
							30	P302621	30°	<i>E 121*</i>
								P311722	30°	<i>E 123*</i>
								P300611	30°	<i>E 113*</i>
								P310611	30°	<i>E 113*</i>
								P301612	30°	<i>E 114*</i>
								P311712	30°	<i>E 122*</i>
								P312673	30°	<i>E 124*</i>
								P312771	30°	<i>E 124*</i>
P	Non-alloyed and low-alloyed steel	annealed (tempered)	210	700	P1, P2, P3, P4, P7	●				
		free cutting steel	220	750	P6	●				
		tempered	300	1010	P5, P8	●				
		tempered	380	1280	P9	●				
		tempered	430	1480	P10	●				
	High-alloyed steel and high-alloyed tool steel	annealed	200	670	P11	●				
		hardened and tempered	300	1010	P12	●				
		hardened and tempered	400	1360	P13	●				
	Stainless steel	ferritic/martensitic, annealed	200	670	P14	●				
		martensitic, tempered	330	1110	P15	●				
M	Stainless steel	austenitic, duplex	230	780	M1, M3					
		austenitic, precipitation hardened (PH)	300	1010	M2					
K	Grey cast iron		245	–	K3, K4					
	Cast iron with spheroidal graphite	ferritic, pearlitic	365	–	K1, K2, K5, K6					
	GGV (CGI)		200	–	K7					
N	Aluminium wrought alloys	cannot be hardened	30	–	N1	●●				
		hardenable, hardened	100	340	N2	●●				
	Cast aluminium alloys	≤ 12% Si	90	310	N3, N4	●●				
		> 12% Si	130	450	N5	●●				
	Magnesium alloys		70	250	N6	●●				
S	Copper and copper alloys (bronze/brass)	non-alloyed, electrolytic copper	100	340	N7	●●				
		brass, bronze, red brass	90	310	N8	●●				
		Cu-alloys, short-chipping	110	380	N9	●●				
		high-strength, Ampco	300	1010	N10	●●				
S	Heat-resistant alloys	Fe-based	280	940	S1, S2	●●				
		Ni or Co base	250	840	S3	●●				
		Ni or Co base	350	1080	S4, S5	●●				
	Titanium alloys	pure titanium	200	670	S6	●●				
		α and β alloys, hardened	375	1260	S7	●●				
	β alloys	410	1400	S8	●●					
	Tungsten alloys		300	1010	S9	●●				
	Molybdenum alloys		300	1010	S10	●●				
H	Hardened steel		50 HRC	–	H1					
			55 HRC	–	H2, H4					
			60 HRC	–	H3					
O	Thermoplasts	without abrasive fillers			O1					
	Thermosetting plastics	without abrasive fillers			O2					
	Plastic, fibre-reinforced	GFRP, AFRP			O3, O5					
		CFRP			O4					
	Graphite (technical)			65	O6					

* The pages indicated in italics refer to the Walter General catalogue 2012.

Walter Select – Shoulder/slot milling with facet Solid carbide routing cutters

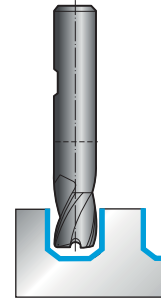
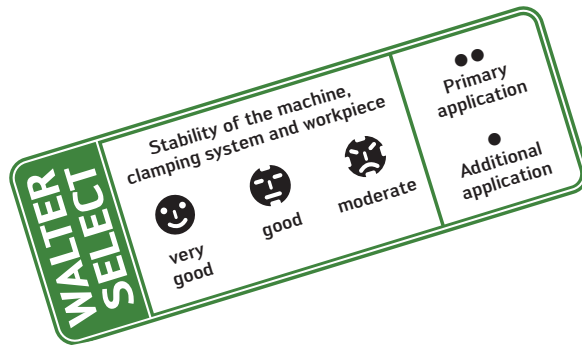
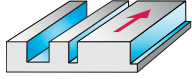

Solid carbide routing cutters

Material group	Grouping of main material groups and code letters	Workpiece material	Brinell hardness HB	Tensile strength R_m N/mm ²	Machining group	Machining conditions			
						Ø range 2.8 – 16 Number of teeth 3 – 4 Coating TAX			
						Family	Designation	λ	Page
						Tough Guys N 50	H3021217 H3121217	50° 50°	<i>E 128*</i> <i>E 128*</i>
P	Non-alloyed and low-alloyed steel	annealed (tempered)	210	700	P1, P2, P3, P4, P7	●●			
		free cutting steel	220	750	P6	●●			
		tempered	300	1010	P5, P8	●●			
		tempered	380	1280	P9	●●			
		tempered	430	1480	P10	●●			
	High-alloyed steel and high-alloyed tool steel	annealed	200	670	P11	●●			
		hardened and tempered	300	1010	P12	●●			
		hardened and tempered	400	1360	P13	●●			
	Stainless steel	ferritic/martensitic, annealed	200	670	P14	●●			
		martensitic, tempered	330	1110	P15	●●			
M	Stainless steel	austenitic, duplex	230	780	M1, M3	●			
		austenitic, precipitation hardened (PH)	300	1010	M2	●			
K	Grey cast iron		245	–	K3, K4	●			
	Cast iron with spheroidal graphite	ferritic, pearlitic	365	–	K1, K2, K5, K6	●			
	GGV (CGI)		200	–	K7	●			
N	Aluminium wrought alloys	cannot be hardened	30	–	N1				
		hardenable, hardened	100	340	N2				
	Cast aluminium alloys	≤ 12% Si	90	310	N3, N4				
		> 12% Si	130	450	N5				
	Magnesium alloys		70	250	N6				
	Copper and copper alloys (bronze/brass)	non-alloyed, electrolytic copper	100	340	N7				
		brass, bronze, red brass	90	310	N8				
		Cu-alloys, short-chipping	110	380	N9				
		high-strength, Ampco	300	1010	N10				
S	Heat-resistant alloys	Fe-based	280	940	S1, S2				
		Ni or Co base	250	840	S3				
		Ni or Co base	350	1080	S4, S5				
	Titanium alloys	pure titanium	200	670	S6	●			
		α and β alloys, hardened	375	1260	S7	●			
		β alloys	410	1400	S8	●			
	Tungsten alloys		300	1010	S9				
	Molybdenum alloys		300	1010	S10				
H	Hardened steel		50 HRC	–	H1				
			55 HRC	–	H2, H4				
			60 HRC	–	H3				
O	Thermoplasts	without abrasive fillers			O1				
	Thermosetting plastics	without abrasive fillers			O2				
	Plastic, fibre-reinforced	GFRP, AFRP			O3, O5				
		CFRP			O4				
	Graphite (technical)			65	O6				

* The pages indicated in italics refer to the Walter General catalogue 2012.

Walter Select – Shoulder/slot milling with facet PCD milling cutter

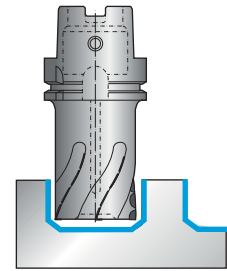
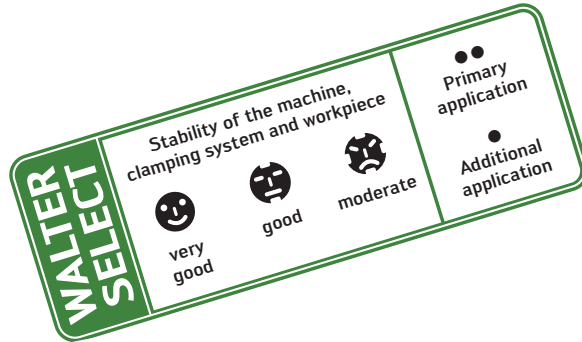
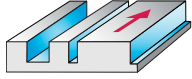

PCD milling cutter

Machining conditions	😊			
Ø range	32 – 63			
Number of teeth	2 + 2			
Coating	PCD			
	Family	Designation	λ	Page

Material group	Grouping of main material groups and code letters		Brinell hardness HB	Tensile strength R _m N/mm ²	Machining group	PCD porcupine cutters	F4726	10°	E 184*	
	Workpiece material									
P	Non-alloyed and low-alloyed steel	annealed (tempered)	210	700	P1, P2, P3, P4, P7					
		free cutting steel	220	750	P6					
		tempered	300	1010	P5, P8					
		tempered	380	1280	P9					
		tempered	430	1480	P10					
	High-alloyed steel and high-alloyed tool steel	annealed	200	670	P11					
hardened and tempered		300	1010	P12						
hardened and tempered		400	1360	P13						
Stainless steel	ferritic/martensitic, annealed	200	670	P14						
	martensitic, tempered	330	1110	P15						
M	Stainless steel	austenitic, duplex	230	780	M1, M3					
		austenitic, precipitation hardened (PH)	300	1010	M2					
K	Grey cast iron		245	–	K3, K4					
	Cast iron with spheroidal graphite	ferritic, pearlitic	365	–	K1, K2, K5, K6					
	GGV (CGI)		200	–	K7					
N	Aluminium wrought alloys	cannot be hardened	30	–	N1	●●				
		hardenable, hardened	100	340	N2	●●				
	Cast aluminium alloys	≤ 12% Si	90	310	N3, N4	●●				
		> 12% Si	130	450	N5	●●				
	Magnesium alloys		70	250	N6	●●				
	Copper and copper alloys (bronze/brass)	non-alloyed, electrolytic copper		100	340	N7	●●			
brass, bronze, red brass			90	310	N8	●●				
Cu-alloys, short-chipping			110	380	N9	●●				
high-strength, Ampco			300	1010	N10	●●				
S	Heat-resistant alloys	Fe-based	280	940	S1, S2					
		Ni or Co base	250	840	S3					
		Ni or Co base	350	1080	S4, S5					
	Titanium alloys	pure titanium	200	670	S6					
		α and β alloys, hardened	375	1260	S7					
		β alloys	410	1400	S8					
	Tungsten alloys		300	1010	S9					
	Molybdenum alloys		300	1010	S10					
	H	Hardened steel		50 HRC	–	H1				
				55 HRC	–	H2, H4				
			60 HRC	–	H3					
O	Thermoplasts	without abrasive fillers			O1					
	Thermosetting plastics	without abrasive fillers			O2					
	Plastic, fibre-reinforced	GFRP, AFRP			O3, O5					
		CFRP			O4					
Graphite (technical)			65	O6						

* The pages indicated in italics refer to the Walter General catalogue 2012.

Walter Select – Shoulder/slot milling with corner radius Solid carbide shank cutters

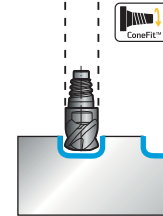
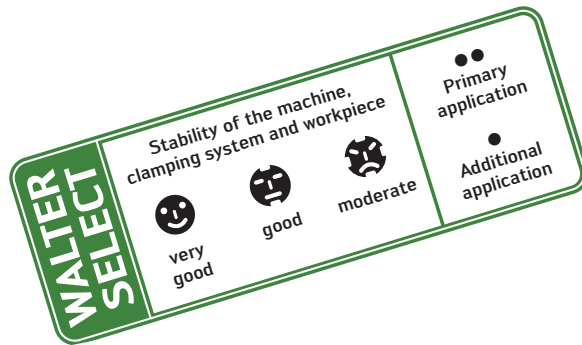
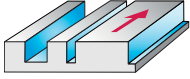

Solid carbide end mills

Machining conditions	☹️			
Ø range	10 – 25 NEW			
Number of teeth	2 – 4			
Coating	TAX			
	Family	Designation	λ	Page

Material group	Grouping of main material groups and code letters	Workpiece material	Brinell hardness HB	Tensile strength R _m N/mm ²	Machining group	ConeFit™				
						Flash	Spade Flash	λ	Page	
P	Non-alloyed and low-alloyed steel	annealed (tempered)	210	700	P1, P2, P3, P4, P7	●●				
		free cutting steel	220	750	P6	●●				
		tempered	300	1010	P5, P8	●●				
		tempered	380	1280	P9	●●				
		tempered	430	1480	P10	●●				
	High-alloyed steel and high-alloyed tool steel	annealed	200	670	P11	●●				
		hardened and tempered	300	1010	P12	●●				
		hardened and tempered	400	1360	P13	●●				
	Stainless steel	ferritic/martensitic, annealed	200	670	P14	●●				
		martensitic, tempered	330	1110	P15	●●				
M	Stainless steel	austenitic, duplex	230	780	M1, M3	●				
		austenitic, precipitation hardened (PH)	300	1010	M2	●				
K	Cast iron	Grey cast iron	245	–	K3, K4	●				
		Cast iron with spheroidal graphite	365	–	K1, K2, K5, K6	●				
		GGV (CGI)	200	–	K7	●				
N	Aluminium wrought alloys	cannot be hardened	30	–	N1					
		hardenable, hardened	100	340	N2					
	Cast aluminium alloys	≤ 12% Si	90	310	N3, N4					
		> 12% Si	130	450	N5					
	Magnesium alloys		70	250	N6					
	Copper and copper alloys (bronze/brass)	non-alloyed, electrolytic copper	100	340	N7					
brass, bronze, red brass		90	310	N8						
Cu-alloys, short-chipping		110	380	N9						
high-strength, Ampco		300	1010	N10						
S	Heat-resistant alloys	Fe-based	280	940	S1, S2					
		Ni or Co base	250	840	S3					
		Ni or Co base	350	1080	S4, S5					
	Titanium alloys	pure titanium	200	670	S6					
		α and β alloys, hardened	375	1260	S7					
		β alloys	410	1400	S8					
	Tungsten alloys		300	1010	S9					
	Molybdenum alloys		300	1010	S10					
	H	Hardened steel		50 HRC	–	H1	●			
				55 HRC	–	H2, H4	●			
			60 HRC	–	H3					
O	Thermoplasts	without abrasive fillers			O1					
	Thermosetting plastics	without abrasive fillers			O2					
	Plastic, fibre-reinforced	GFRP, AFRP			O3, O5					
		CFRP			O4					
Graphite (technical)			65	O6						

* The pages indicated in italics refer to the Walter General catalogue 2012.

Walter Select – Shoulder/slot milling with corner radius

Solid carbide shank cutters

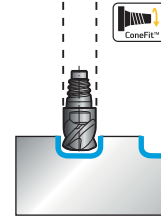
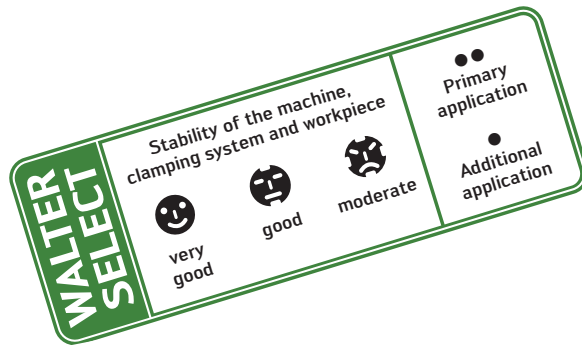
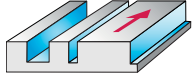

Solid carbide end mills

Machining conditions	☺			
Ø range	10 – 12 NEW			
Number of teeth	4			
Coating	DIA			
	Family	Designation	λ	Page

Material group	Grouping of main material groups and code letters		Brinell hardness HB	Tensile strength R _m N/mm ²	Machining group	Machining conditions			
	Workpiece material					Family	Designation	λ	Page
P	Non-alloyed and low-alloyed steel	annealed (tempered)	210	700	P1, P2, P3, P4, P7	ConeFit™ N 50	H3E20419	50°	E-55
		free cutting steel	220	750	P6				
		tempered	300	1010	P5, P8				
		tempered	380	1280	P9				
		tempered	430	1480	P10				
	High-alloyed steel and high-alloyed tool steel	annealed	200	670	P11				
		hardened and tempered	300	1010	P12				
		hardened and tempered	400	1360	P13				
	Stainless steel	ferritic/martensitic, annealed	200	670	P14				
		martensitic, tempered	330	1110	P15				
M	Stainless steel	austenitic, duplex	230	780	M1, M3				
		austenitic, precipitation hardened (PH)	300	1010	M2				
K	Grey cast iron		245	–	K3, K4				
	Cast iron with spheroidal graphite	ferritic, pearlitic	365	–	K1, K2, K5, K6				
	GGV (CGI)		200	–	K7				
N	Aluminium wrought alloys	cannot be hardened	30	–	N1				
		hardenable, hardened	100	340	N2				
	Cast aluminium alloys	≤ 12% Si	90	310	N3, N4				
		> 12% Si	130	450	N5				
	Magnesium alloys		70	250	N6				
		Copper and copper alloys (bronze/brass)	non-alloyed, electrolytic copper	100	340	N7			
brass, bronze, red brass			90	310	N8				
Cu-alloys, short-chipping			110	380	N9				
high-strength, Ampco	300		1010	N10					
S	Heat-resistant alloys	Fe-based	280	940	S1, S2				
		Ni or Co base	250	840	S3				
		Ni or Co base	350	1080	S4, S5				
	Titanium alloys	pure titanium	200	670	S6				
		α and β alloys, hardened	375	1260	S7				
		β alloys	410	1400	S8				
			300	1010	S9				
	Tungsten alloys		300	1010	S9				
	Molybdenum alloys		300	1010	S10				
	H	Hardened steel		50 HRC	–	H1			
			55 HRC	–	H2, H4				
			60 HRC	–	H3				
O	Thermoplasts	without abrasive fillers			O1				
	Thermosetting plastics	without abrasive fillers			O2				
	Plastic, fibre-reinforced	GFRP, AFRP				O3, O5			
		CFRP				O4			
	Graphite (technical)		65		O6				

* The pages indicated in italics refer to the Walter General catalogue 2012.

Walter Select – Shoulder/slot milling with corner radius

Solid carbide shank cutters

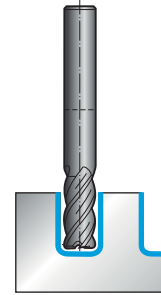
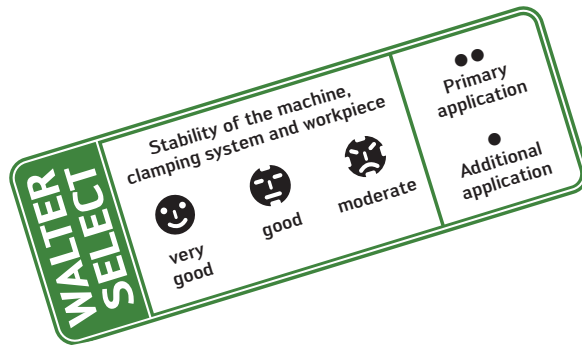
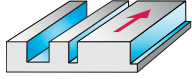

Solid carbide end mills

Material group	Grouping of main material groups and code letters	Workpiece material	Brinell hardness HB	Tensile strength R_m N/mm ²	Machining group	Machining conditions			
						Family	Designation	λ	Page
						Machining conditions: Ø range: 0,6 – 12 Number of teeth: 2 Coating: uncoated			
						HSC 30	H800881 H800891	30° 30°	<i>E 153*</i> <i>E 154*</i>
Material group	Grouping of main material groups and code letters	Workpiece material	Brinell hardness HB	Tensile strength R_m N/mm ²	Machining group				
P	Non-alloyed and low-alloyed steel	annealed (tempered)	210	700	P1, P2, P3, P4, P7				
		free cutting steel	220	750	P6				
		tempered	300	1010	P5, P8				
		tempered	380	1280	P9				
		tempered	430	1480	P10				
	High-alloyed steel and high-alloyed tool steel	annealed	200	670	P11				
		hardened and tempered	300	1010	P12				
hardened and tempered		400	1360	P13					
Stainless steel	ferritic/martensitic, annealed	200	670	P14					
	martensitic, tempered	330	1110	P15					
M	Stainless steel	austenitic, duplex	230	780	M1, M3				
		austenitic, precipitation hardened (PH)	300	1010	M2				
K	Grey cast iron		245	–	K3, K4				
	Cast iron with spheroidal graphite	ferritic, pearlitic	365	–	K1, K2, K5, K6				
	GGV (CGI)		200	–	K7				
N	Aluminium wrought alloys	cannot be hardened	30	–	N1		●●		
		hardenable, hardened	100	340	N2		●●		
	Cast aluminium alloys	≤ 12% Si	90	310	N3, N4		●●		
		> 12% Si	130	450	N5		●●		
	Magnesium alloys		70	250	N6		●●		
	Copper and copper alloys (bronze/brass)	non-alloyed, electrolytic copper	100	340	N7		●●		
		brass, bronze, red brass	90	310	N8		●●		
Cu-alloys, short-chipping		110	380	N9		●●			
high-strength, Ampco		300	1010	N10		●●			
S	Heat-resistant alloys	Fe-based	280	940	S1, S2				
		Ni or Co base	250	840	S3				
		Ni or Co base	350	1080	S4, S5				
	Titanium alloys	pure titanium	200	670	S6				
		α and β alloys, hardened	375	1260	S7				
		β alloys	410	1400	S8				
	Tungsten alloys		300	1010	S9				
Molybdenum alloys		300	1010	S10					
H	Hardened steel		50 HRC	–	H1				
			55 HRC	–	H2, H4				
			60 HRC	–	H3				
O	Thermoplasts	without abrasive fillers			O1				
	Thermosetting plastics	without abrasive fillers			O2				
	Plastic, fibre-reinforced	GFRP, AFRP			O3, O5				
		CFRP			O4				
Graphite (technical)			65	O6					

* The pages indicated in italics refer to the Walter General catalogue 2012.

Walter Select – Shoulder/slot milling with corner radius

Solid carbide shank cutters

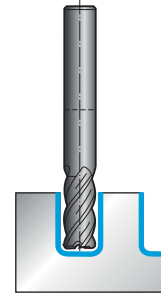
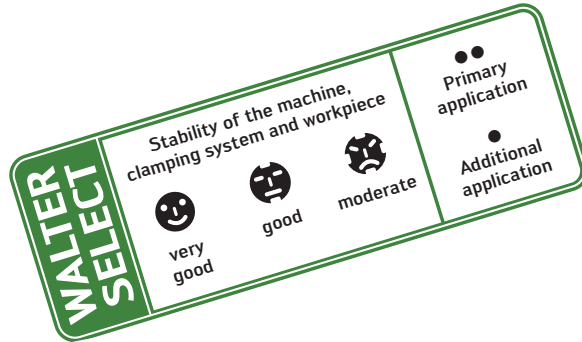
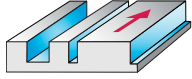

Solid carbide end mills

Machining conditions	😊			
Ø range	0,4 – 3			
Number of teeth	2			
Coating	DIA			
	Family	Designation	λ	Page

Material group	Grouping of main material groups and code letters		Brinell hardness HB	Tensile strength R _m N/mm ²	Machining group	Machining conditions			
	Workpiece material					Family	Designation	λ	Page
P	Non-alloyed and low-alloyed steel	annealed (tempered)	210	700	P1, P2, P3, P4, P7	Mini HSC 30	H4044919	30°	<i>E 162*</i>
		free cutting steel	220	750	P6				
		tempered	300	1010	P5, P8				
		tempered	380	1280	P9				
		tempered	430	1480	P10				
	High-alloyed steel and high-alloyed tool steel	annealed	200	670	P11				
		hardened and tempered	300	1010	P12				
		hardened and tempered	400	1360	P13				
	Stainless steel	ferritic/martensitic, annealed	200	670	P14				
		martensitic, tempered	330	1110	P15				
M	Stainless steel	austenitic, duplex	230	780	M1, M3				
		austenitic, precipitation hardened (PH)	300	1010	M2				
K	Grey cast iron		245	–	K3, K4				
	Cast iron with spheroidal graphite	ferritic, pearlitic	365	–	K1, K2, K5, K6				
	GGV (CGI)		200	–	K7				
N	Aluminium wrought alloys	cannot be hardened	30	–	N1				
		hardenable, hardened	100	340	N2				
	Cast aluminium alloys	≤ 12% Si	90	310	N3, N4				
		> 12% Si	130	450	N5				
	Magnesium alloys		70	250	N6				
		Copper and copper alloys (bronze/brass)	non-alloyed, electrolytic copper	100	340	N7			
brass, bronze, red brass			90	310	N8				
Cu-alloys, short-chipping			110	380	N9				
high-strength, Ampco	300		1010	N10					
S	Heat-resistant alloys	Fe-based	280	940	S1, S2				
		Ni or Co base	250	840	S3				
		Ni or Co base	350	1080	S4, S5				
	Titanium alloys	pure titanium	200	670	S6				
		α and β alloys, hardened	375	1260	S7				
		β alloys	410	1400	S8				
	Tungsten alloys		300	1010	S9				
	Molybdenum alloys		300	1010	S10				
	H	Hardened steel		50 HRC	–	H1			
				55 HRC	–	H2, H4			
			60 HRC	–	H3				
O	Thermoplasts	without abrasive fillers			O1				
	Thermosetting plastics	without abrasive fillers			O2				
	Plastic, fibre-reinforced	GFRP, AFRP				O3, O5			
		CFRP				O4			
	Graphite (technical)		65		O6				

* The pages indicated in italics refer to the Walter General catalogue 2012.

Walter Select – Shoulder/slot milling with roughing profile Solid carbide roughing milling cutters

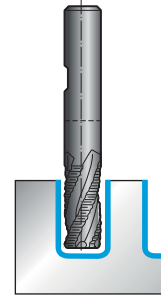
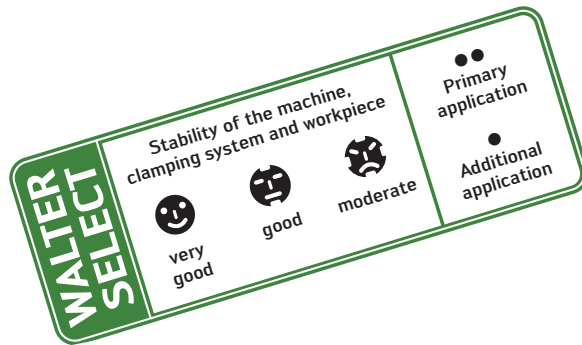
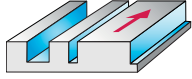

Solid carbide roughing milling cutters

Material group	Grouping of main material groups and code letters	Workpiece material	Brinell hardness HB	Tensile strength R _m N/mm ²	Machining group	Machining conditions			
						☺			
						Machining conditions Ø range: 16 – 25 Number of teeth: 3 Coating: uncoated + CRN			
						Family	Designation	λ	Page
						Sky-tec™ AL Rapax G 30	H608391 H6083914	30° 30°	<i>E 173*</i> <i>E 173*</i>
P	Non-alloyed and low-alloyed steel	annealed (tempered)	210	700	P1, P2, P3, P4, P7				
		free cutting steel	220	750	P6				
		tempered	300	1010	P5, P8				
		tempered	380	1280	P9				
		tempered	430	1480	P10				
	High-alloyed steel and high-alloyed tool steel	annealed	200	670	P11				
		hardened and tempered	300	1010	P12				
		hardened and tempered	400	1360	P13				
	Stainless steel	ferritic/martensitic, annealed	200	670	P14				
		martensitic, tempered	330	1110	P15				
M	Stainless steel	austenitic, duplex	230	780	M1, M3				
		austenitic, precipitation hardened (PH)	300	1010	M2				
K	Grey cast iron		245	–	K3, K4				
	Cast iron with spheroidal graphite	ferritic, pearlitic	365	–	K1, K2, K5, K6				
	GGV (CGI)		200	–	K7				
N	Aluminium wrought alloys	cannot be hardened	30	–	N1	●●			
		hardenable, hardened	100	340	N2	●●			
	Cast aluminium alloys	≤ 12% Si	90	310	N3, N4	●●			
		> 12% Si	130	450	N5	●●			
	Magnesium alloys		70	250	N6	●●			
S	Copper and copper alloys (bronze/brass)	non-alloyed, electrolytic copper	100	340	N7	●●			
		brass, bronze, red brass	90	310	N8	●●			
		Cu-alloys, short-chipping	110	380	N9	●●			
		high-strength, Ampco	300	1010	N10	●●			
S	Heat-resistant alloys	Fe-based	280	940	S1, S2				
		Ni or Co base	250	840	S3				
		Ni or Co base	350	1080	S4, S5				
	Titanium alloys	pure titanium	200	670	S6				
		α and β alloys, hardened	375	1260	S7				
		β alloys	410	1400	S8				
Tungsten alloys		300	1010	S9					
Molybdenum alloys		300	1010	S10					
H	Hardened steel		50 HRC	–	H1				
			55 HRC	–	H2, H4				
			60 HRC	–	H3				
O	Thermoplasts	without abrasive fillers			O1	●			
	Thermosetting plastics	without abrasive fillers			O2	●			
	Plastic, fibre-reinforced	GFRP, AFRP			O3, O5				
		CFRP			O4				
	Graphite (technical)			65	O6				

* The pages indicated in italics refer to the Walter General catalogue 2012.

Walter Select – Shoulder/slot milling with roughing profile HSS roughing milling cutters

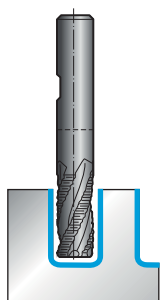

Solid carbide roughing milling cutters

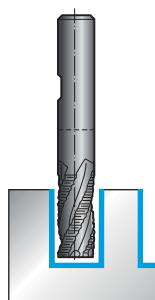

HSS roughing milling cutters

6 – 25				6 – 32				6 – 32				6 – 50				
4				3 – 6				4 – 6				3 – 6				
ACN				ACN				ACN				uncoated				
Family	Designation	λ	Page	Family	Designation	λ	Page	Family	Designation	λ	Page	Family	Designation	λ	Page	
Ti NS 30	H3083017	30°	<i>E 172*</i>	FS 45	P3123087	45°	<i>E 174*</i>	NF Rapax G 30	P3121017	30°	<i>E 180*</i>	NRA Kordel G 35	P312001	35°	<i>E 177*</i>	
	H3183017	30°	<i>E 172*</i>		P3120017	35°	<i>E 177*</i>		HR Kordel F 30	P3120387	30°		<i>E 179*</i>	P312011	35°	<i>E 177*</i>
				NRA Kordel G 35	P3120117	35°	<i>E 177*</i>	HR Kordel F 30	P3128417	30°	<i>E 179*</i>	HRA Kordel F 35	P312021	35°	<i>E 175*</i>	
					P3120217	35°	<i>E 175*</i>		HNR Kordel F 30	P3120537	30°		<i>E 178*</i>	P312028	35°	<i>E 175*</i>
				HRA Kordel F 35	P3120287	35°	<i>E 175*</i>	HNR Kordel F 30	P3120937	30°	<i>E 178*</i>	NR Kordel G 30	P352011	30°	<i>E 182*</i>	
					P4110217	35°	<i>E 175*</i>		NF Rapax G 30	P312111	30°		<i>E 180*</i>			
					NR Kordel G 30	P3120717	30°			<i>E 181*</i>						

Walter Select – Shoulder/slot milling with roughing profile HSS shell end mill

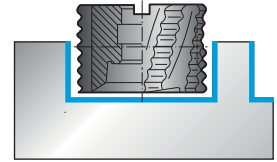
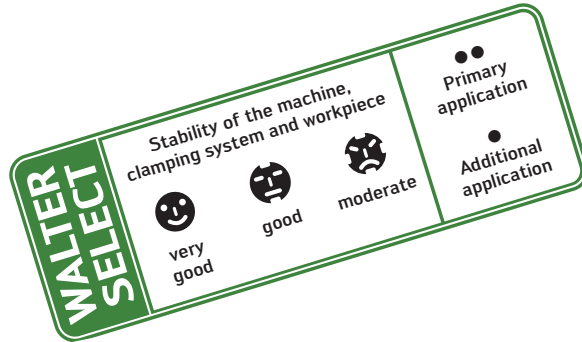
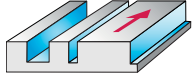
HSS shell end mill

Machining conditions				
Ø range	40 – 100			
Number of teeth	6 – 12			
Coating	TiCN			
	Family	Designation	λ	Page

Material group	Grouping of main material groups and code letters	Workpiece material	Brinell hardness HB	Tensile strength R _m N/mm ²	Machining group	Machining conditions				
						Family	Designation	λ	Page	
						HR Kordel F 25	P0201016	25°	<i>E 183*</i>	
P	Non-alloyed and low-alloyed steel	annealed (tempered)	210	700	P1, P2, P3, P4, P7	●●				
		free cutting steel	220	750	P6	●●				
		tempered	300	1010	P5, P8	●●				
		tempered	380	1280	P9	●●				
		tempered	430	1480	P10	●●				
	High-alloyed steel and high-alloyed tool steel	annealed	200	670	P11	●●				
		hardened and tempered	300	1010	P12	●●				
		hardened and tempered	400	1360	P13	●●				
	Stainless steel	ferritic/martensitic, annealed	200	670	P14	●●				
		martensitic, tempered	330	1110	P15	●●				
M	Stainless steel	austenitic, duplex	230	780	M1, M3	●				
		austenitic, precipitation hardened (PH)	300	1010	M2	●				
K	Grey cast iron		245	–	K3, K4	●				
	Cast iron with spheroidal graphite	ferritic, pearlitic	365	–	K1, K2, K5, K6	●				
	GGV (CGI)		200	–	K7	●				
N	Aluminium wrought alloys	cannot be hardened	30	–	N1	●				
		hardenable, hardened	100	340	N2	●				
	Cast aluminium alloys	≤ 12% Si	90	310	N3, N4	●				
		> 12% Si	130	450	N5	●				
	Magnesium alloys		70	250	N6	●				
	Copper and copper alloys (bronze/brass)	non-alloyed, electrolytic copper	100	340	N7	●				
		brass, bronze, red brass	90	310	N8	●				
Cu-alloys, short-chipping		110	380	N9	●					
high-strength, Ampco		300	1010	N10	●					
S	Heat-resistant alloys	Fe-based	280	940	S1, S2					
		Ni or Co base	250	840	S3					
		Ni or Co base	350	1080	S4, S5					
	Titanium alloys	pure titanium	200	670	S6					
		α and β alloys, hardened	375	1260	S7					
		β alloys	410	1400	S8					
	Tungsten alloys		300	1010	S9					
	Molybdenum alloys		300	1010	S10					
	H	Hardened steel		50 HRC	–	H1				
				55 HRC	–	H2, H4				
			60 HRC	–	H3					
O	Thermoplasts	without abrasive fillers			O1					
	Thermosetting plastics	without abrasive fillers			O2					
	Plastic, fibre-reinforced	GFRP, AFRP			O3, O5					
		CFRP			O4					
Graphite (technical)			65	O6						

* The pages indicated in italics refer to the Walter General catalogue 2012.

End mills Proto-max™_{ST}



Materials to 52 HRC

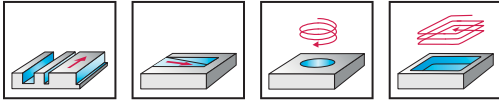

- VHM
- Long reach
- 4 cutting edges
- With centre cut
- 50° helix angle

Special features:

Slot milling: $a_p \leq 0.47 \times D_c$

Shoulder milling: $a_e \leq 0.5 \times D_c$

	P	M	K	N	S	H	O
TAZ	●●	●	●	●	●	●	●

P standard	D _c h ₁₀ mm	L _c mm	l ₄ mm	d ₂ mm	l ₁ mm	SW mm	d ₁	Z	TAZ
									Designation H4E34217
ConeFit™	10	4,75	12,4	9,7	23,6	8	E10	4	★ -E10-10
	12	5,75	14,5	11,7	28,3	10	E12	4	★ -E12-12
	16	7,5	18,7	15,5	35,7	12	E16	4	★ -E16-16
	20	9,85	21,3	19,3	40,8	16	E20	4	★ -E20-20

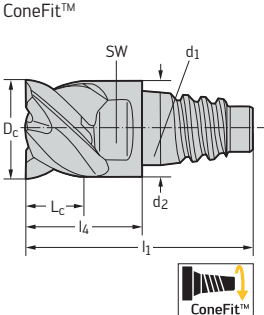

★ New addition to range

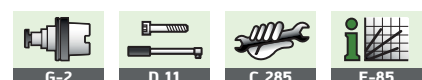

End mills

Proto-max™_{ST}



Materials to 52 HRC

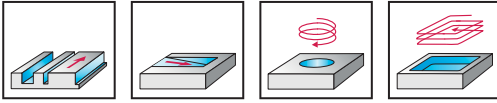

- VHM
- Long reach
- 4 cutting edges
- With centre cut
- 50° helix angle

Special features:

Slot milling: $a_p \leq 1.5 \times D_c$

Shoulder milling: $a_e \leq 0.5 \times D_c$

	P	M	K	N	S	H	O
TAZ	●●	●	●	●	●	●	●

P standard	D_c h9 mm	L_c mm	l_3 mm	d_2 mm	l_1 mm	l_4 mm	d_1 h6 mm	Z	TAZ Designation H4034217
Shank DIN 6535 HA	3	5	8,5	2,9	57	21	6	4	-3
	4	7	11	3,8	57	21	6	4	-4
	5	8	14	4,75	57	21	6	4	-5
	6	10	16	5,7	57	21	6	4	-6
	8	13	22	7,6	63	27	8	4	-8
	10	16	28	9,5	72	32	10	4	-10
	12	19	33	11,4	83	38	12	4	-12
	14	22	36	13,3	83	38	14	4	-14
	16	26	42	15,2	92	44	16	4	-16
	18	29	42	17,1	92	44	18	4	-18
	20	32	52	19	104	54	20	4	-20

P standard	D_c h9 mm	L_c mm	l_3 mm	d_2 mm	l_1 mm	l_4 mm	d_1 h6 mm	Z	TAZ Designation H4134217
Shank DIN 6535 HB	10	16	28	9,5	72	32	10	4	★ -10
	12	19	33	11,4	83	38	12	4	★ -12
	14	22	36	13,3	83	38	14	4	★ -14
	16	26	42	15,2	92	44	16	4	★ -16
	18	29	42	17,1	92	44	18	4	★ -18
	20	32	52	19	104	54	20	4	★ -20

End mills Proto-max™_{ST}



Materials to 52 HRC

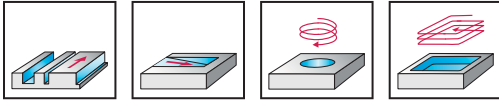

- VHM
- Long reach
- 3 cutting edges
- With centre cut
- 45° helix angle

Special features:

Slot milling: $a_p \leq 2.0 \times D_c$

Shoulder milling: $a_e \leq 0.3 \times D_c$

	P	M	K	N	S	H	O
TAZ	●●	●	■	■	■	■	■

P standard	D_c h9 mm	L_c mm	l_3 mm	d_2 mm	l_1 mm	l_4 mm	d_1 h6 mm	Z	TAZ Designation H4033217
Shank DIN 6535 HA	2	5	7,5	1,92	57	21	6	3	-2
	3	7	10,5	2,9	57	21	6	3	-3
	4	9	15	3,8	57	21	6	3	-4
	5	11	16	4,75	57	21	6	3	-5
	6	13	19	5,7	57	21	6	3	-6
	8	18	25	7,6	63	27	8	3	-8
	10	22	30	9,5	72	32	10	3	-10
	12	26	36	11,4	83	38	12	3	-12
	16	34	42	15,2	92	44	16	3	-16
	20	42	52	19	104	54	20	3	-20

P standard	D_c h9 mm	L_c mm	l_3 mm	d_2 mm	l_1 mm	l_4 mm	d_1 h6 mm	Z	TAZ Designation H4133217
Shank DIN 6535 HB	10	22	30	9,5	72	32	10	3	★ -10
	12	26	36	11,4	83	38	12	3	★ -12
	16	34	42	15,2	92	44	16	3	★ -16
	20	42	52	19	104	54	20	3	★ -20

★ New addition to range



End mills Proto-max™_{Inox}

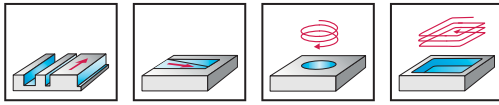

Special features:

Slot milling: $a_p \leq 0.4 \times D_c$

Shoulder milling: $a_e \leq 0.5 \times D_c$

- VHM
- 4 to 5 cutting edges
- With centre cut
- 50° helix angle
- With internal cooling

	P	M	K	N	S	H	O
TAA		●●			●		

P standard	D _c h10 mm	L _c mm	l ₄ mm	d ₂ mm	l ₁ mm	SW mm	d ₁	Z	TAA Designation H2EC34217
ConeFit™	10	6	12,4	9,7	23,8	8	E10	4	★ -E10-10
	12	7,5	14,5	11,7	28,3	10	E12	4	★ -E12-12
	16	10	18,7	15,5	35,7	12	E16	4	★ -E16-16
	20	12	21,3	19,3	40,8	16	E20	4	★ -E20-20
	25	15	25,6	24,2	49,6	20	E25	5	★ -E25-25

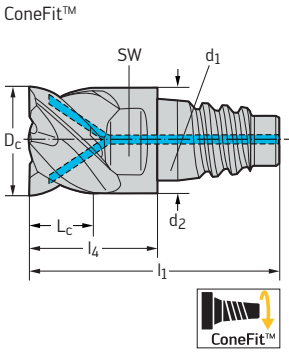

★ New addition to range



End mills

Proto-max™_{Inox}

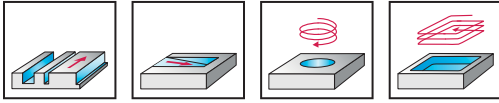

- VHM
- Long reach
- 4 cutting edges
- With centre cut
- 35°/38° helix angle
- With helical coolant channels

Special features:

 Slot milling: $a_p \leq 1.0 \times D_c$

 Shoulder milling: $a_e \leq 0.6 \times D_c$

	P	M	K	N	S	H	O
TAA		●●			●		

DIN 6527 L	D _c h10 mm	L _c mm	l ₁ mm	l ₄ mm	d ₁ h5 mm	Z	TAA Designation H2034217
Shank DIN 6535 HA	6	13	57	21	6	4	★ -6
	8	19	63	27	8	4	★ -8
	10	22	72	32	10	4	★ -10
	12	26	83	38	12	4	★ -12
	14	26	83	38	14	4	★ -14
	16	32	92	44	16	4	★ -16
	18	32	92	44	18	4	★ -18
	20	38	104	54	20	4	★ -20

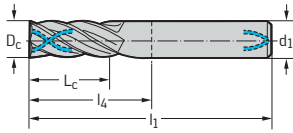

DIN 6527 L	D _c h10 mm	L _c mm	l ₁ mm	l ₄ mm	d ₁ h5 mm	Z	TAA Designation H2134217
Shank DIN 6535 HB	10	22	72	32	10	4	★ -10
	12	26	83	38	12	4	★ -12
	14	26	83	38	14	4	★ -14
	16	32	92	44	16	4	★ -16
	18	32	92	44	18	4	★ -18
	20	38	104	54	20	4	★ -20

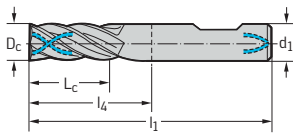

End mills Proto-max™_{TG}



Materials to 48 HRC

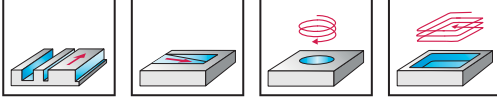

- VHM
- 3 to 4 cutting edges
- With centre cut
- 50° helix angle

Special features:

Slot milling: $a_p \leq 0.9 \times D_c$

Shoulder milling: $a_e \leq 0.3 \times D_c$

	P	M	K	N	S	H	O
TAT	●●	●	●	●	●	●	●

P norm L	D _c h10 mm	L _c mm	l ₁ mm	l ₄ mm	d ₁ h5 mm	Z	TAT
							Designation H3021178
Shank DIN 6535 HA 	2	7	57	21	6	3	★ -2
	2,5	8	57	21	6	3	★ -2.5
	3	8	57	21	6	3	★ -3
	3,5	10	57	21	6	3	★ -3.5
	4	11	57	21	6	3	★ -4
	4,5	11	57	21	6	3	★ -4.5
	5	13	57	21	6	3	★ -5
	6	13	65	29	6	4	★ -6
	7	16	80	44	8	4	★ -7
	8	19	80	44	8	4	★ -8
	9	19	100	60	10	4	★ -9
	10	22	100	60	10	4	★ -10
	11	26	100	55	12	4	★ -11
	12	26	100	55	12	4	★ -12
	14	26	104	59	14	4	★ -14
	16	32	115	67	16	4	★ -16
	20	38	125	75	20	4	★ -20

End mills

Proto-max™_{TG}



Materials to 48 HRC

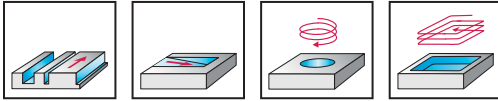

- VHM
- 4 to 5 cutting edges
- With centre cut
- 50° helix angle

Special features:

Slot milling: $a_p \leq 0.9 \times D_c$

Shoulder milling: $a_e \leq 0.3 \times D_c$

	P	M	K	N	S	H	O
TAT	●●	●	●	●	●	●	●

DIN 6527 L	D _c h10 mm	L _c mm	l ₁ mm	l ₄ mm	d ₁ h5 mm	Z	TAT Designation H3021378
Shank DIN 6535 HA	6	13	57	21	6	4	★ -6
	8	19	63	27	8	4	★ -8
	10	22	72	32	10	4	★ -10
	12	26	83	38	12	4	★ -12
	14	26	83	38	14	4	★ -14
	16	32	92	44	16	4	★ -16
	18	32	92	44	18	4	★ -18
	20	38	104	54	20	4	★ -20
	25	45	121	65	25	5	★ -25

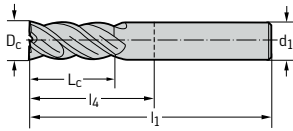

DIN 6527 L	D _c h10 mm	L _c mm	l ₁ mm	l ₄ mm	d ₁ h5 mm	Z	TAT Designation H3121378
Shank DIN 6535 HB	6	13	57	21	6	4	★ -6
	8	19	63	27	8	4	★ -8
	10	22	72	32	10	4	★ -10
	12	26	83	38	12	4	★ -12
	14	26	83	38	14	4	★ -14
	16	32	92	44	16	4	★ -16
	18	32	92	44	18	4	★ -18
	20	38	104	54	20	4	★ -20
	25	45	121	65	25	5	★ -25

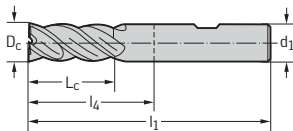

End mills Proto-max™_{TG}



Materials to 48 HRC

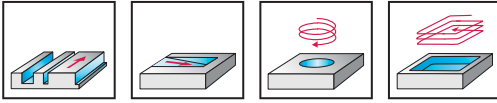

- VHM
- Long reach
- 4 cutting edges
- With centre cut
- 50° helix angle

Special features:

Slot milling: $a_p \leq 0.9 \times D_c$

Shoulder milling: $a_e \leq 0.3 \times D_c$

	P	M	K	N	S	H	O
TAT	●●	●	●				

DIN 6527 L	D_c h10 mm	L_c mm	l_3 mm	d_2 mm	l_1 mm	l_4 mm	d_1 h5 mm	Z	TAT Designation H4121078
Shank DIN 6535 HB	6	13	19	5,7	57	21	6	4	★ -6
	8	19	25	7,6	63	27	8	4	★ -8
	10	22	30	9,5	72	32	10	4	★ -10
	12	26	36	11,4	83	38	12	4	★ -12
	14	26	36	13,3	83	38	14	4	★ -14
	16	32	42	15,2	92	44	16	4	★ -16
	20	38	52	19	104	54	20	4	★ -20

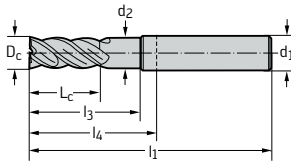

End mills

Proto-max™_{TG}



Materials to 48 HRC

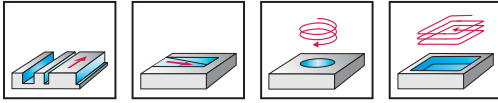

- VHM
- Long reach
- 3 to 4 cutting edges
- With centre cut
- 50° helix angle

Special features:

Slot milling: $a_p \leq 0.9 \times D_c$

Shoulder milling: $a_e \leq 0.3 \times D_c$

	P	M	K	N	S	H	O
TAT	●●	●	●				

P norm L	D_c h10 mm	L_c mm	l_3 mm	d_2 mm	l_1 mm	l_4 mm	d_1 h5 mm	Z	TAT Designation H4121178
Shank DIN 6535 HB	4	11	15	3,8	57	21	6	3	★ -4
	5	13	16	4,75	57	21	6	3	★ -5
	6	13	27	5,7	65	29	6	4	★ -6
	8	19	42	7,6	80	44	8	4	★ -8
	10	22	58	9,5	100	60	10	4	★ -10
	12	26	53	11,4	100	55	12	4	★ -12
	14	26	57	13,3	104	59	14	4	★ -14
	16	32	65	15,2	115	67	16	4	★ -16
	20	38	73	19	125	75	20	4	★ -20

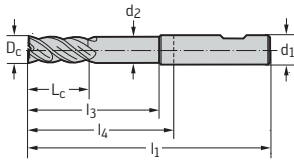

★ New addition to range



End mills

Proto-max™_{TG}



Materials to 48 HRC

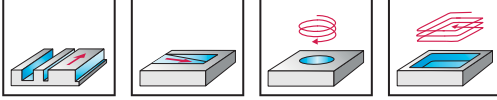

Special features:

Slot milling: $a_p \leq 0.9 \times D_c$

Shoulder milling: $a_e \leq 0.3 \times D_c$

- VHM
- Long reach
- 4 cutting edges
- With centre cut
- 50° helix angle

	P	M	K	N	S	H	O
TAT	●●	●	●				

DIN 6527 L	D_c h10 mm	L_c mm	l_3 mm	d_2 mm	l_1 mm	l_4 mm	d_1 h5 mm	Z	TAT Designation H4121278
Shank DIN 6535 HB	6	6	19	5,7	57	21	6	4	★ -6
	8	8	25	7,6	63	27	8	4	★ -8
	10	10	30	9,5	72	32	10	4	★ -10
	12	12	36	11,4	83	38	12	4	★ -12
	14	14	36	13,3	83	38	14	4	★ -14
	16	16	42	15,2	92	44	16	4	★ -16

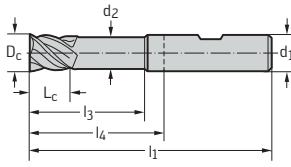

End mills with corner radius Proto-max™_{ST}



Materials to 52 HRC

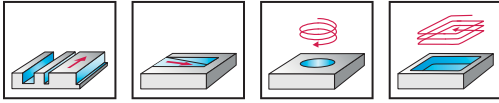

- VHM
- Long reach
- 4 cutting edges
- With centre cut
- 50° helix angle

Special features:

Slot milling: $a_p \leq 0.47 \times D_c$

Shoulder milling: $a_e \leq 0.5 \times D_c$

	P	M	K	N	S	H	O
TAZ	●●	●	●	●	●	●	●

P standard	D _c h _g mm	R mm	L _c mm	l ₄ mm	d ₂ mm	l ₁ mm	SW mm	d ₁	Z	TAZ
										Designation H4E38217
	10	0,5	4,75	12,4	9,7	23,6	8	E10	4	★ -E10-10-0.5
	10	1	4,75	12,4	9,7	23,6	8	E10	4	★ -E10-10-1
	10	1,5	4,75	12,4	9,7	23,6	8	E10	4	★ -E10-10-1.5
	10	2	4,75	12,4	9,7	23,6	8	E10	4	★ -E10-10-2
	10	3	4,75	12,4	9,7	23,6	8	E10	4	★ -E10-10-3
	12	0,5	5,75	14,5	11,7	28,3	10	E12	4	★ -E12-12-0.5
	12	1	5,75	14,5	11,7	28,3	10	E12	4	★ -E12-12-1
	12	1,5	5,75	14,5	11,7	28,3	10	E12	4	★ -E12-12-1.5
	12	2	5,75	14,5	11,7	28,3	10	E12	4	★ -E12-12-2
	12	3	5,75	14,5	11,7	28,3	10	E12	4	★ -E12-12-3
	12	4	5,75	14,5	11,7	28,3	10	E12	4	★ -E12-12-4
	16	0,5	7,5	18,7	15,5	35,7	12	E16	4	★ -E16-16-0.5
	16	1	7,5	18,7	15,5	35,7	12	E16	4	★ -E16-16-1
	16	1,5	7,5	18,7	15,5	35,7	12	E16	4	★ -E16-16-1.5
	16	2	7,5	18,7	15,5	35,7	12	E16	4	★ -E16-16-2
	16	3	7,5	18,7	15,5	35,7	12	E16	4	★ -E16-16-3
	16	4	7,5	18,7	15,5	35,7	12	E16	4	★ -E16-16-4
	20	0,5	9,85	21,3	19,3	40,8	16	E20	4	★ -E20-20-0.5
	20	1	9,85	21,3	19,3	40,8	16	E20	4	★ -E20-20-1
	20	2	9,85	21,3	19,3	40,8	16	E20	4	★ -E20-20-2
20	3	9,85	21,3	19,3	40,8	16	E20	4	★ -E20-20-3	
20	4	9,85	21,3	19,3	40,8	16	E20	4	★ -E20-20-4	

★ New addition to range

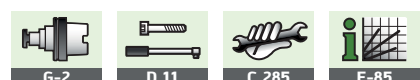

End mills with corner radius

Proto-max™_{ST}



Materials to 52 HRC

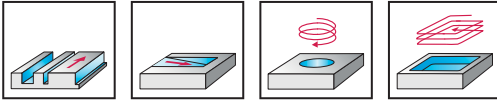

- VHM
- Long reach
- 4 cutting edges
- With centre cut
- 50° helix angle

Special features:

Slot milling: $a_p \leq 1.5 \times D_c$

Shoulder milling: $a_e \leq 0.5 \times D_c$

	P	M	K	N	S	H	O
TAZ	●●	●	●	●	●	●	●

P standard	D_c h9 mm	R mm	L_c mm	l_3 mm	d_2 mm	l_1 mm	l_4 mm	d_1 h6 mm	Z	TAZ Designation H4038217
Shank DIN 6535 HA	3	0,2	5	8,5	2,9	57	21	6	4	-3-0,2
	3	0,5	5	8,5	2,9	57	21	6	4	-3-0,5
	4	0,2	7	11	3,8	57	21	6	4	-4-0,2
	4	0,5	7	11	3,8	57	21	6	4	-4-0,5
	5	0,5	8	14	4,75	57	21	6	4	-5-0,5
	5	1	8	14	4,75	57	21	6	4	-5-1
	6	0,5	10	16	5,7	57	21	6	4	-6-0,5
	6	1	10	16	5,7	57	21	6	4	-6-1
	8	0,5	13	22	7,6	63	27	8	4	-8-0,5
	8	1	13	22	7,6	63	27	8	4	-8-1
	8	2	13	22	7,6	63	27	8	4	-8-2
	10	0,5	16	28	9,5	72	32	10	4	-10-0,5
	10	1	16	28	9,5	72	32	10	4	-10-1
	10	2	16	28	9,5	72	32	10	4	-10-2
	12	0,5	19	33	11,4	83	38	12	4	-12-0,5
	12	1	19	33	11,4	83	38	12	4	-12-1
	12	2	19	33	11,4	83	38	12	4	-12-2
	16	0,5	26	42	15,2	92	44	16	4	-16-0,5
	16	1	26	42	15,2	92	44	16	4	-16-1
	16	2	26	42	15,2	92	44	16	4	-16-2
20	1	32	52	19	104	54	20	4	-20-1	
20	2	32	52	19	104	54	20	4	-20-2	
20	4	32	52	19	104	54	20	4	-20-4	

P standard	D_c h9 mm	R mm	L_c mm	l_3 mm	d_2 mm	l_1 mm	l_4 mm	d_1 h6 mm	Z	TAZ Designation H4138217
Shank DIN 6535 HB	10	0,5	16	28	9,5	72	32	10	4	★ -10-0,5
	10	1	16	28	9,5	72	32	10	4	★ -10-1
	10	2	16	28	9,5	72	32	10	4	★ -10-2
	12	0,5	19	33	11,4	83	38	12	4	★ -12-0,5
	12	1	19	33	11,4	83	38	12	4	★ -12-1
	12	2	19	33	11,4	83	38	12	4	★ -12-2
	16	0,5	26	42	15,2	92	44	16	4	★ -16-0,5
	16	1	26	42	15,2	92	44	16	4	★ -16-1
	16	2	26	42	15,2	92	44	16	4	★ -16-2
	20	1	32	52	19	104	54	20	4	★ -20-1
	20	2	32	52	19	104	54	20	4	★ -20-2
	20	4	32	52	19	104	54	20	4	★ -20-4

★ New addition to range



End mills with corner radius Proto-max™_{ST}



Materials to 52 HRC

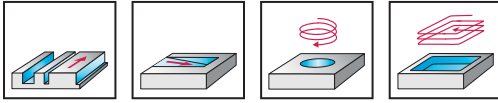

- VHM
- Long reach
- 3 cutting edges
- With centre cut
- 45° helix angle

Special features:

Slot milling: $a_p \leq 2,0 \times D_c$

Shoulder milling: $a_e \leq 0,3 \times D_c$

	P	M	K	N	S	H	O
TAZ	●●	●	●	●	●	●	●

P standard	D_c h9 mm	R mm	L_c mm	l_3 mm	d_2 mm	l_1 mm	l_4 mm	d_1 h6 mm	Z	TAZ Designation H4036217
Shank DIN 6535 HA	2	0,08	5	7,5	1,92	57	21	6	3	-2
	3	0,08	7	10,5	2,9	57	21	6	3	-3
	4	0,08	9	15	3,8	57	21	6	3	-4
	5	0,16	11	16	4,75	57	21	6	3	-5
	6	0,16	13	19	5,7	57	21	6	3	-6
	8	0,16	18	25	7,6	63	27	8	3	-8
	10	0,25	22	30	9,5	72	32	10	3	-10
	12	0,25	26	36	11,4	83	38	12	3	-12
	16	0,25	34	42	15,2	92	44	16	3	-16
	20	0,4	42	52	19	104	54	20	3	-20

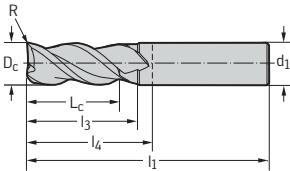

End mills with corner radius

Proto-max™_{Inox}

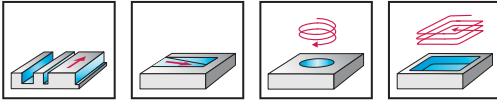

Special features:

Slot milling: $a_p \leq 0.4 \times D_c$

Shoulder milling: $a_e \leq 0.5 \times D_c$

- VHM
- 4 to 5 cutting edges
- With centre cut
- 50° helix angle
- With internal cooling

	P	M	K	N	S	H	O
TAA		●●			●		

P standard

ConeFit™

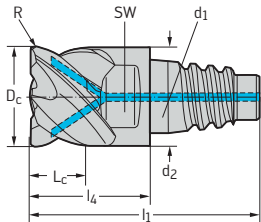

D _c h _g mm	R mm	L _c mm	l ₄ mm	d ₂ mm	l ₁ mm	SW mm	d ₁	Z	TAA Designation H2EC38217
10	0,5	6	12,4	9,7	23,6	8	E10	4	★ -E10-10-0.5
10	1	6	12,4	9,7	23,6	8	E10	4	★ -E10-10-1
10	1,5	6	12,4	9,7	23,6	8	E10	4	★ -E10-10-1.5
10	2	6	12,4	9,7	23,6	8	E10	4	★ -E10-10-2
10	3	6	12,4	9,7	23,6	8	E10	4	★ -E10-10-3
12	0,5	7,5	14,5	11,7	28,3	10	E12	4	★ -E12-12-0.5
12	1	7,5	14,5	11,7	28,3	10	E12	4	★ -E12-12-1
12	1,5	7,5	14,5	11,7	28,3	10	E12	4	★ -E12-12-1.5
12	2	7,5	14,5	11,7	28,3	10	E12	4	★ -E12-12-2
12	3	7,5	14,5	11,7	28,3	10	E12	4	★ -E12-12-3
12	4	7,5	14,5	11,7	28,3	10	E12	4	★ -E12-12-4
16	1	10	18,7	15,5	35,7	12	E16	4	★ -E16-16-1
16	1,5	10	18,7	15,5	35,7	12	E16	4	★ -E16-16-1.5
16	2	10	18,7	15,5	35,7	12	E16	4	★ -E16-16-2
16	3	10	18,7	15,5	35,7	12	E16	4	★ -E16-16-3
16	4	10	18,7	15,5	35,7	12	E16	4	★ -E16-16-4
20	1	12	21,3	19,3	40,8	16	E20	4	★ -E20-20-1
20	1,5	12	21,3	19,3	40,8	16	E20	4	★ -E20-20-1.5
20	2	12	21,3	19,3	40,8	16	E20	4	★ -E20-20-2
20	3	12	21,3	19,3	40,8	16	E20	4	★ -E20-20-3
20	4	12	21,3	19,3	40,8	16	E20	4	★ -E20-20-4
25	1	15	25,6	24,2	49,6	20	E25	5	★ -E25-25-1
25	1,5	15	25,6	24,2	49,6	20	E25	5	★ -E25-25-1.5
25	2	15	25,6	24,2	49,6	20	E25	5	★ -E25-25-2
25	3	15	25,6	24,2	49,6	20	E25	5	★ -E25-25-3
25	4	15	25,6	24,2	49,6	20	E25	5	★ -E25-25-4

★ New addition to range

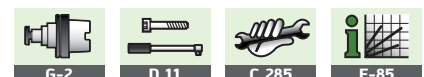

End mills with corner radius

Proto-max™_{Inox}

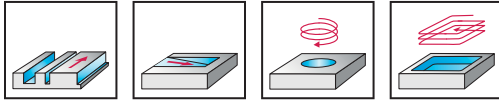

- VHM
- Long reach
- 4 cutting edges
- With centre cut
- 35°/38° helix angle
- With helical coolant channels

Special features:

 Slot milling: $a_p \leq 1.0 \times D_c$

 Shoulder milling: $a_e \leq 0.6 \times D_c$

	P	M	K	N	S	H	O
TAA		●●			●		

DIN 6527 L	D_c h9 mm	R mm	L_c mm	l_1 mm	l_4 mm	d_1 h5 mm	Z	TAA Designation H2038217
Shank DIN 6535 HA	6	0,5	13	57	21	6	4	★ -6-0.5
	6	1	13	57	21	6	4	★ -6-1
	8	0,5	19	63	27	8	4	★ -8-0.5
	8	1	19	63	27	8	4	★ -8-1
	8	2	19	63	27	8	4	★ -8-2
	10	0,5	22	72	32	10	4	★ -10-0.5
	10	1	22	72	32	10	4	★ -10-1
	10	2	22	72	32	10	4	★ -10-2
	10	3	22	72	32	10	4	★ -10-3
	12	0,5	26	83	38	12	4	★ -12-0.5
	12	1	26	83	38	12	4	★ -12-1
	12	2	26	83	38	12	4	★ -12-2
	12	3	26	83	38	12	4	★ -12-3
	16	0,5	32	92	44	16	4	★ -16-0.5
	16	1	32	92	44	16	4	★ -16-1
	16	2	32	92	44	16	4	★ -16-2
	16	3	32	92	44	16	4	★ -16-3
	20	1	38	104	54	20	4	★ -20-1
	20	2	38	104	54	20	4	★ -20-2
	20	3	38	104	54	20	4	★ -20-3
20	4	38	104	54	20	4	★ -20-4	

DIN 6527 L	D_c h9 mm	R mm	L_c mm	l_1 mm	l_4 mm	d_1 h5 mm	Z	TAA Designation H2138217
Shank DIN 6535 HB	10	0,5	22	72	32	10	4	★ -10-0.5
	10	1	22	72	32	10	4	★ -10-1
	10	2	22	72	32	10	4	★ -10-2
	10	3	22	72	32	10	4	★ -10-3
	12	0,5	26	83	38	12	4	★ -12-0.5
	12	1	26	83	38	12	4	★ -12-1
	12	2	26	83	38	12	4	★ -12-2
	12	3	26	83	38	12	4	★ -12-3
	16	0,5	32	92	44	16	4	★ -16-0.5
	16	1	32	92	44	16	4	★ -16-1
	16	2	32	92	44	16	4	★ -16-2
	16	3	32	92	44	16	4	★ -16-3
	20	1	38	104	54	20	4	★ -20-1
	20	2	38	104	54	20	4	★ -20-2
	20	3	38	104	54	20	4	★ -20-3
	20	4	38	104	54	20	4	★ -20-4

★ New addition to range



End mills with corner radius

Proto-max™_{Inox}

with Flash geometry



Materials to 55 HRC

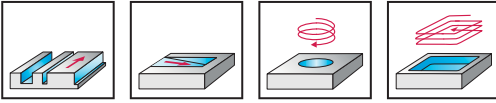

- VHM
- 4 cutting edges
- Without centre cut
- 50° helix angle
- With internal cooling

Special features:

Shoulder milling: $a_e \leq 0.5 \times D_c$

	P	M	K	N	S	H	O
TAA		●●			●		

P standard	D _c h9 mm	a _{pf}	x _f mm	R _f	R _{ers}	R mm	L _c mm	l ₄ mm	d ₂ mm	l ₁ mm	SW mm	d ₁	Z	TAA
														Designation H2EC94717
ConeFit™	10	0,7	1,7	5	1,99	1,5	6	12,4	9,7	23,6	8	E10	4	★ -E10-10
	12	0,8	2,25	6	2,1	1,5	7,5	14,5	11,7	28,3	10	E12	4	★ -E12-12
	16	1	3,1	8	2,747	2	10	18,7	15,5	35,7	12	E16	4	★ -E16-16
	20	1,3	4	10	3,072	2	12	21,3	19,3	40,8	16	E20	4	★ -E20-20

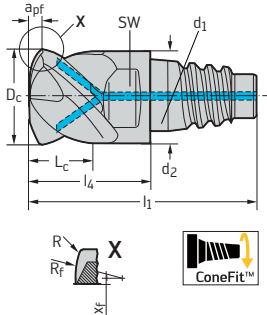

★ New addition to range

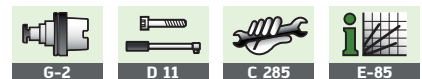

End mills with corner radius Protostar® Flash



Materials to 55 HRC

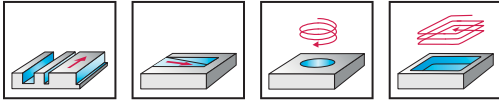

- Solid carbide/spade
- Long reach
- 2 cutting edges
- Without centre cut
- 10° helix angle

Special features:

Slot milling: $a_p \leq 0.6 \times D_c$

Shoulder milling: $a_e \leq 0.5 \times D_c$

	P	M	K	N	S	H	O
TAX	●●	●	●	●	●	●	●

P standard														TAX Designation H1E92718	
	D_c h12 mm	a_{pf}	x_f mm	R_f	R_{ers}	R mm	L_c mm	d_2 mm	l_1 mm	l_4 mm	SW mm	d_1	Z		
ConeFit™	10	0,3	1,7	5	1,99	1,5	8	9,7	23	11,8	6	E10	2	★ -E10-10	
	12	0,8	2,25	6	2,1	1,5	10	11,7	27,8	14	8	E12	2	★ -E12-12	
	16	1	3,1	8	2,747	2	13	15,5	35,1	18,1	10	E16	2	★ -E16-16	

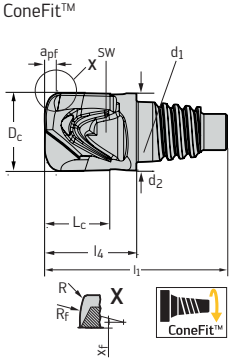

★ New addition to range

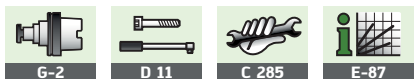

End mills with corner radius Protostar® N 50

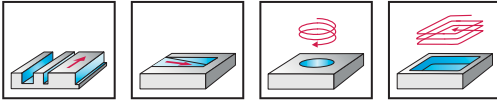

- VHM
- 4 cutting edges
- With centre cut
- 50° helix angle

Special features:

Slot milling: $a_p \leq 0.5 \times D_c$

Shoulder milling: $a_e \leq 0.5 \times D_c$

	P	M	K	N	S	H	O
DIA							●●

P standard	D _c h10 mm	R mm	L _c mm	L ₄ mm	d ₂ mm	l ₁ mm	SW mm	d ₁ mm	Z	DIA
										Designation H3E20419
ConeFit™	10	0,5	5,5	12,4	9,7	23,6	8	E10	4	★ -E10-10-0.5
	10	1	5,5	12,4	9,7	23,6	8	E10	4	★ -E10-10-1
	10	1,5	5,5	12,4	9,7	23,6	8	E10	4	★ -E10-10-1.5
	10	2	5,5	12,4	9,7	23,6	8	E10	4	★ -E10-10-2
	12	0,5	6,5	14,5	11,7	28,3	10	E12	4	★ -E12-12-0.5
	12	1	6,5	14,5	11,7	28,3	10	E12	4	★ -E12-12-1
	12	1,5	6,5	14,5	11,7	28,3	10	E12	4	★ -E12-12-1.5
	12	2	6,5	14,5	11,7	28,3	10	E12	4	★ -E12-12-2

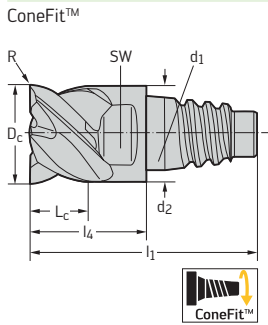

★ New addition to range



End mills with corner radius

Protostar® N 10

N 10



Materials to 48 HRC

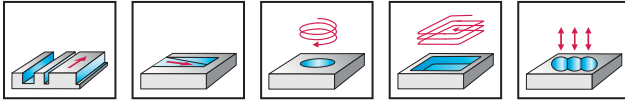

- Solid carbide/spade
- 2 cutting edges
- With centre cut
- 10° helix angle

Special features:

Slot milling: $a_p \leq 0.8 \times D_c$

Shoulder milling: $a_e \leq 0.5 \times D_c$

	P	M	K	N	S	H	O
TAX	●●	●	●	●	●	●	●

P standard	D_c h10 mm	R mm	L_c mm	d_2 mm	l_1 mm	l_4 mm	SW mm	d_1	Z	TAX
										Designation H1E12018
ConeFit™ 	10	0,2	8	9,7	23	11,8	6	E10	2	★ -E10-10-0.2
	10	0,5	8	9,7	23	11,8	6	E10	2	★ -E10-10-0.5
	10	0,8	8	9,7	23	11,8	6	E10	2	★ -E10-10-0.8
	10	1	8	9,7	23	11,8	6	E10	2	★ -E10-10-1.0
	10	1,2	8	9,7	23	11,8	6	E10	2	★ -E10-10-1.2
	10	1,5	8	9,7	23	11,8	6	E10	2	★ -E10-10-1.5
	10	2	8	9,7	23	11,8	6	E10	2	★ -E10-10-2.0
	10	2,5	8	9,7	23	11,8	6	E10	2	★ -E10-10-2.5
	10	3	8	9,7	23	11,8	6	E10	2	★ -E10-10-3.0
	12	3	10	11,7	27,8	14	8	E12	2	★ -E12-12-3.0
	12	2,5	10	11,7	27,8	14	8	E12	2	★ -E12-12-2.5
	12	2	10	11,7	27,8	14	8	E12	2	★ -E12-12-2.0
	12	1,6	10	11,7	27,8	14	8	E12	2	★ -E12-12-1.6
	12	1,5	10	11,7	27,8	14	8	E12	2	★ -E12-12-1.5
	12	1,2	10	11,7	27,8	14	8	E12	2	★ -E12-12-1.2
	12	1	10	11,7	27,8	14	8	E12	2	★ -E12-12-1.0
	12	0,8	10	11,7	27,8	14	8	E12	2	★ -E12-12-0.8
	12	0,5	10	11,7	27,8	14	8	E12	2	★ -E12-12-0.5
	12	0,2	10	11,7	27,8	14	8	E12	2	★ -E12-12-0.2
	16	0,2	13	15,5	35,1	18,1	10	E16	2	★ -E16-16-0.2
16	0,5	13	15,5	35,1	18,1	10	E16	2	★ -E16-16-0.5	
16	0,8	13	15,5	35,1	18,1	10	E16	2	★ -E16-16-0.8	
16	1	13	15,5	35,1	18,1	10	E16	2	★ -E16-16-1.0	
16	1,2	13	15,5	35,1	18,1	10	E16	2	★ -E16-16-1.2	
16	1,5	13	15,5	35,1	18,1	10	E16	2	★ -E16-16-1.5	
16	2	13	15,5	35,1	18,1	10	E16	2	★ -E16-16-2.0	
16	3	13	15,5	35,1	18,1	10	E16	2	★ -E16-16-3.0	
16	4	13	15,5	35,1	18,1	10	E16	2	★ -E16-16-4.0	

★ New addition to range

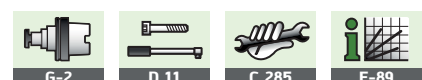

Roughing milling cutters Protostar® HR Kordel F 40 Qmax



Materials to 48 HRC

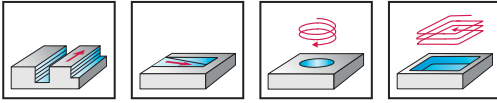

- VHM
- 4 to 8 cutting edges
- With centre cut
- 40° helix angle

Special features:

Slot milling: $a_p \leq 0.5 \times D_c$

Shoulder milling: $a_e \leq 0.5 \times D_c$

	P	M	K	N	S	H	O
TAX	●	●●	■	■	■	■	■

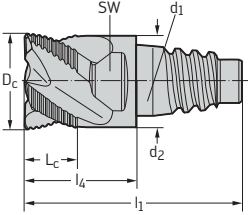
P standard	D_c	L_c	d_2	l_1	l_4	SW	d_1	Z	TAX
	h10 mm	mm	mm	mm	mm	mm	mm		Designation H3E82378
ConeFit™	10	5,5	9,7	23	12	8	E10	4	-E10-10
	12	6,5	11,7	28	15	10	E12	4	-E12-12
	16	8,5	15,5	36	19	12	E16	4	-E16-16
	20	11	19,3	41	21	16	E20	6	★ -E20-20
	25	13,5	24,2	50	26	20	E25	8	★ -E25-25



★ New addition to range



Roughing milling cutters with corner radius

Protostar® HR Kordel F 45

Qmax



Materials to 48 HRC

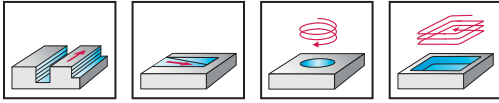

- VHM
- 5 to 6 cutting edges
- With centre cut
- 45° helix angle

Special features:

Slot milling: $a_p \leq 1.5 \times D_c$

Shoulder milling: $a_e \leq 0.6 \times D_c$

	P	M	K	N	S	H	O
TAX	●●	●	●				

DIN 6527 L	D_c h12 mm	R mm	L_c mm	l_1 mm	l_4 mm	d_1 h6 mm	Z	TAX Designation H3186378
Shank DIN 6535 HB	12	1	26	83	38	12	5	★ -12-1
	12	1,5	26	83	38	12	5	★ -12-1.5
	12	2	26	83	38	12	5	★ -12-2
	12	3	26	83	38	12	5	★ -12-3
	16	1	32	92	44	16	6	★ -16-1
	16	2	32	92	44	16	6	★ -16-2
	16	3	32	92	44	16	6	★ -16-3
	16	4	32	92	44	16	6	★ -16-4
	20	2	38	104	54	20	6	★ -20-2
	20	3	38	104	54	20	6	★ -20-3
	20	4	38	104	54	20	6	★ -20-4

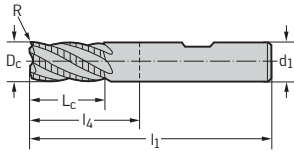

Roughing milling cutters with corner radius Protostar® HR Kordel F 40 Qmax



Materials to 48 HRC

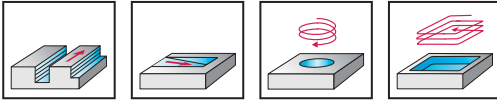

- VHM
- 4 cutting edges
- With centre cut
- 40° helix angle

Special features:

Slot milling: $a_p \leq 1.5 \times D_c$

Shoulder milling: $a_e \leq 0.6 \times D_c$

	P	M	K	N	S	H	O
TAX	●	●●	●	●	●	●	●

DIN 6527 L	D_c h12 mm	R mm	L_c mm	l_1 mm	l_4 mm	d_1 h6 mm	Z	TAX Designation H3183378
Shank DIN 6535 HB	6	1	13	57	21	6	4	★ -6-1
	8	1	19	63	27	8	4	★ -8-1
	10	1	22	72	32	10	4	★ -10-1
	10	1,5	22	72	32	10	4	★ -10-1.5
	10	2	22	72	32	10	4	★ -10-2
	12	1	26	83	38	12	4	★ -12-1
	12	1,5	26	83	38	12	4	★ -12-1.5
	12	2	26	83	38	12	4	★ -12-2
	12	3	26	83	38	12	4	★ -12-3
	16	1	32	92	44	16	4	★ -16-1
	16	2	32	92	44	16	4	★ -16-2
	16	3	32	92	44	16	4	★ -16-3
	16	4	32	92	44	16	4	★ -16-4
	20	2	38	104	54	20	4	★ -20-2
	20	3	38	104	54	20	4	★ -20-3
	20	4	38	104	54	20	4	★ -20-4

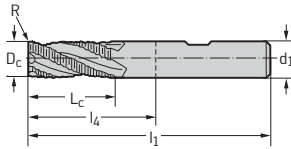

Walter Select – Copy milling

Solid carbide shank cutters

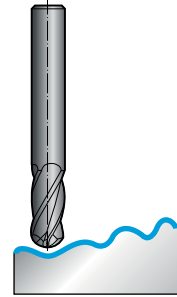
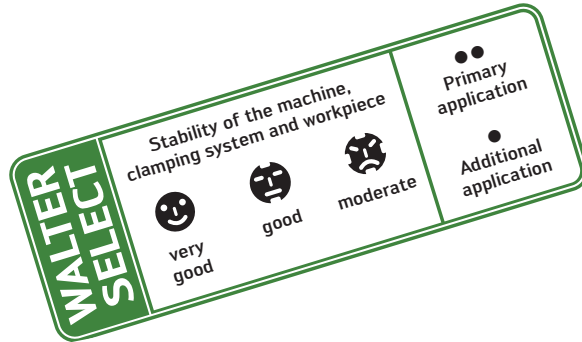
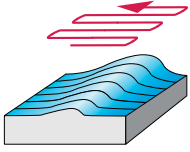

Solid carbide end mills

Material group	Grouping of main material groups and code letters	Workpiece material	Brinell hardness HB	Tensile strength R _m N/mm ²	Machining group	Machining conditions			
						 Ø range 1 – 25 NEW			
						Number of teeth 2 + 4			
Coating						TAX			
						Family	Designation	λ	Page
P	Non-alloyed and low-alloyed steel	annealed (tempered)	210	700	P1, P2, P3, P4, P7	ConeFit™ N 40	H8E11118	40°	<i>E 192*</i>
		free cutting steel	220	750	P6		H8E01118	40°	<i>E 192*</i>
		tempered	300	1010	P5, P8	N 30	H8001118	30°	<i>E 194*</i>
		tempered	380	1280	P9		H8011118	30°	<i>E 193*</i>
		tempered	430	1480	P10		H8111118	30°	<i>E 193*</i>
	High-alloyed steel and high-alloyed tool steel	annealed	200	670	P11	ConeFit™ N 10 Spade	H1E01118	10°	E-71
		hardened and tempered	300	1010	P12				
		hardened and tempered	400	1360	P13				
	Stainless steel	ferritic/martensitic, annealed	200	670	P14				
		martensitic, tempered	330	1110	P15				
M	Stainless steel	austenitic, duplex	230	780	M1, M3				
		austenitic, precipitation hardened (PH)	300	1010	M2				
K	Grey cast iron		245	–	K3, K4				
	Cast iron with spheroidal graphite	ferritic, pearlitic	365	–	K1, K2, K5, K6				
	GGV (CGI)		200	–	K7				
N	Aluminium wrought alloys	cannot be hardened	30	–	N1				
		hardenable, hardened	100	340	N2				
	Cast aluminium alloys	≤ 12% Si	90	310	N3, N4				
		> 12% Si	130	450	N5				
	Copper and copper alloys (bronze/brass)	Magnesium alloys		70	250	N6			
			non-alloyed, electrolytic copper	100	340	N7			
brass, bronze, red brass			90	310	N8				
Cu-alloys, short-chipping			110	380	N9				
S	Heat-resistant alloys	high-strength, Ampco	300	1010	N10				
		Fe-based	280	940	S1, S2				
		Ni or Co base	250	840	S3				
	Titanium alloys	Ni or Co base	350	1080	S4, S5				
		pure titanium	200	670	S6				
		α and β alloys, hardened	375	1260	S7				
		β alloys	410	1400	S8				
	Tungsten alloys		300	1010	S9				
	Molybdenum alloys		300	1010	S10				
	H	Hardened steel		50 HRC	–	H1			
			55 HRC	–	H2, H4				
			60 HRC	–	H3				
O	Thermoplasts	without abrasive fillers			O1				
	Thermosetting plastics	without abrasive fillers			O2				
	Plastic, fibre-reinforced	GFRP, AFRP			O3, O5				
		CFRP			O4				
	Graphite (technical)			65	O6				

* The pages indicated in italics refer to the Walter General catalogue 2012.

Walter Select – Copy milling

Solid carbide shank cutters

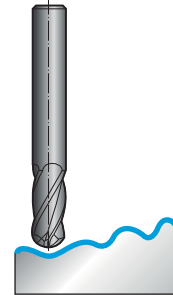
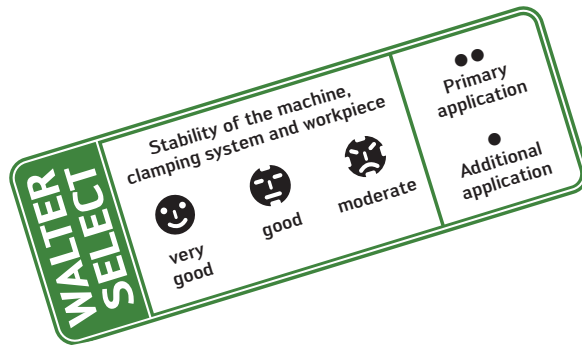
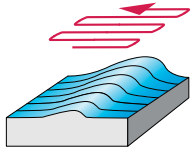

Solid carbide end mills

Material group		Grouping of main material groups and code letters	Workpiece material	Brinell hardness HB	Tensile strength R_m N/mm ²	Machining group	Machining conditions			
							Family	Designation	λ	Page
							☺			
							Ø range 1 – 16			
							Number of teeth 2 + 4			
							Coating TAX			
							Ultra	H8004028	30°	<i>E 200*</i>
							HSC 30 (48–63 HRC)	H8004128	30°	<i>E 200*</i>
								H8004728	30°	<i>E 201*</i>
								H8006428	30°	<i>E 202*</i>
								H8014028	30°	<i>E 203*</i>
								H8014128	30°	<i>E 204*</i>
								H8016428	30°	<i>E 202*</i>
							H8074128	30°	<i>E 203*</i>	
P	Non-alloyed and low-alloyed steel	annealed (tempered)	210	700	P1, P2, P3, P4, P7					
		free cutting steel	220	750	P6					
		tempered	300	1010	P5, P8					
		tempered	380	1280	P9					
		tempered	430	1480	P10					
	High-alloyed steel and high-alloyed tool steel	annealed	200	670	P11					
		hardened and tempered	300	1010	P12					
		hardened and tempered	400	1360	P13					
	Stainless steel	ferritic/martensitic, annealed	200	670	P14					
		martensitic, tempered	330	1110	P15					
M	Stainless steel	austenitic, duplex	230	780	M1, M3					
		austenitic, precipitation hardened (PH)	300	1010	M2					
K	Grey cast iron		245	–	K3, K4					
	Cast iron with spheroidal graphite	ferritic, pearlitic	365	–	K1, K2, K5, K6					
	GGV (CGI)		200	–	K7					
N	Aluminium wrought alloys	cannot be hardened	30	–	N1					
		hardenable, hardened	100	340	N2					
	Cast aluminium alloys	≤ 12% Si	90	310	N3, N4					
		> 12% Si	130	450	N5					
	Magnesium alloys		70	250	N6					
Copper and copper alloys (bronze/brass)	non-alloyed, electrolytic copper		100	340	N7					
			90	310	N8					
			110	380	N9					
			300	1010	N10					
S	Heat-resistant alloys	Fe-based	280	940	S1, S2					
		Ni or Co base	250	840	S3					
		Ni or Co base	350	1080	S4, S5					
	Titanium alloys	pure titanium	200	670	S6					
		α and β alloys, hardened	375	1260	S7					
	β alloys	410	1400	S8						
Tungsten alloys		300	1010	S9						
Molybdenum alloys		300	1010	S10						
H	Hardened steel		50 HRC	–	H1	●●				
			55 HRC	–	H2, H4	●●				
			60 HRC	–	H3	●●				
O	Thermoplasts	without abrasive fillers			O1					
	Thermosetting plastics	without abrasive fillers			O2					
	Plastic, fibre-reinforced	GFRP, AFRP			O3, O5					
		CFRP			O4					
Graphite (technical)			65	O6						

* The pages indicated in italics refer to the Walter General catalogue 2012.

Walter Select – Copy milling Solid carbide shank cutters

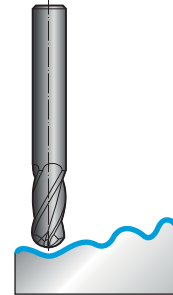
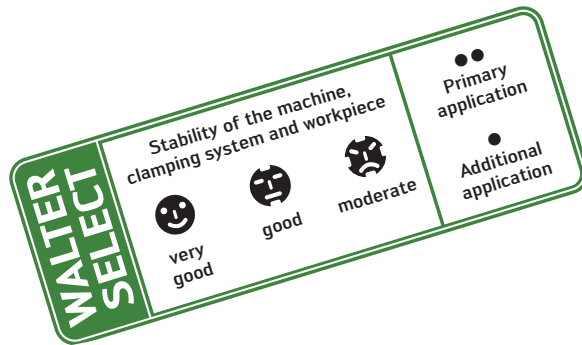
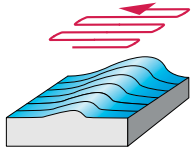

Solid carbide end mills

Machining conditions	😊			
Ø range	0,3 – 3			
Number of teeth	2			
Coating	TAX			
	Family	Designation	λ	Page

Material group	Grouping of main material groups and code letters		Brinell hardness HB	Tensile strength R _m N/mm ²	Machining group	Ultra mini HSC 30 (48–63 HRC)	Designation	λ	Page
	Workpiece material								
P	Non-alloyed and low-alloyed steel	annealed (tempered)	210	700	P1, P2, P3, P4, P7				
		free cutting steel	220	750	P6				
		tempered	300	1010	P5, P8				
		tempered	380	1280	P9				
		tempered	430	1480	P10	●●			
P	High-alloyed steel and high-alloyed tool steel	annealed	200	670	P11				
		hardened and tempered	300	1010	P12				
		hardened and tempered	400	1360	P13				
P	Stainless steel	ferritic/martensitic, annealed	200	670	P14				
		martensitic, tempered	330	1110	P15				
M	Stainless steel	austenitic, duplex	230	780	M1, M3				
		austenitic, precipitation hardened (PH)	300	1010	M2				
K	Grey cast iron		245	–	K3, K4				
	Cast iron with spheroidal graphite	ferritic, pearlitic	365	–	K1, K2, K5, K6				
	GGV (CGI)		200	–	K7				
N	Aluminium wrought alloys	cannot be hardened	30	–	N1				
		hardenable, hardened	100	340	N2				
	Cast aluminium alloys	≤ 12% Si	90	310	N3, N4				
		> 12% Si	130	450	N5				
	Magnesium alloys		70	250	N6				
N	Copper and copper alloys (bronze/brass)	non-alloyed, electrolytic copper	100	340	N7				
		brass, bronze, red brass	90	310	N8				
		Cu-alloys, short-chipping	110	380	N9				
		high-strength, Ampco	300	1010	N10				
S	Heat-resistant alloys	Fe-based	280	940	S1, S2				
		Ni or Co base	250	840	S3				
		Ni or Co base	350	1080	S4, S5				
	Titanium alloys	pure titanium	200	670	S6				
		α and β alloys, hardened	375	1260	S7				
		β alloys	410	1400	S8				
	Tungsten alloys		300	1010	S9				
Molybdenum alloys		300	1010	S10					
H	Hardened steel		50 HRC	–	H1	●●			
			55 HRC	–	H2, H4	●●			
			60 HRC	–	H3	●●			
O	Thermoplasts	without abrasive fillers			O1				
	Thermosetting plastics	without abrasive fillers			O2				
	Plastic, fibre-reinforced	GFRP, AFRP			O3, O5				
		CFRP			O4				
	Graphite (technical)			65	O6				

* The pages indicated in italics refer to the Walter General catalogue 2012.

Walter Select – Copy milling HSS end mills

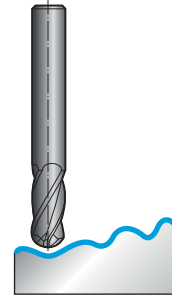
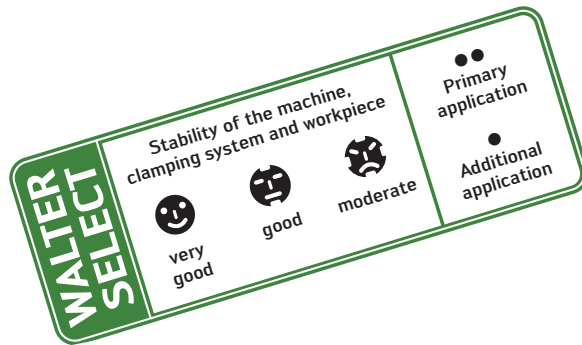
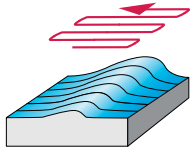

HSS end mills

Material group	Grouping of main material groups and code letters	Workpiece material	Brinell hardness HB	Tensile strength R _m N/mm ²	Machining group	Machining conditions			
						Family	Designation	λ	Page
						Machining conditions: 2 – 20 Ø range: 2 + 4 Number of teeth: ACN Coating:			
						30	P3166017 P3166117 P8112017	30° 30° 30°	<i>E 210*</i> <i>E 211*</i> <i>E 212*</i>
P	Non-alloyed and low-alloyed steel	annealed (tempered)	210	700	P1, P2, P3, P4, P7			••	
		free cutting steel	220	750	P6			••	
		tempered	300	1010	P5, P8			••	
		tempered	380	1280	P9			••	
		tempered	430	1480	P10			••	
	High-alloyed steel and high-alloyed tool steel	annealed	200	670	P11			••	
		hardened and tempered	300	1010	P12			••	
		hardened and tempered	400	1360	P13			••	
	Stainless steel	ferritic/martensitic, annealed	200	670	P14			••	
		martensitic, tempered	330	1110	P15			••	
M	Stainless steel	austenitic, duplex	230	780	M1, M3			••	
		austenitic, precipitation hardened (PH)	300	1010	M2			••	
K	Grey cast iron		245	–	K3, K4			••	
	Cast iron with spheroidal graphite	ferritic, pearlitic	365	–	K1, K2, K5, K6			••	
	GGV (CGI)		200	–	K7			••	
N	Aluminium wrought alloys	cannot be hardened	30	–	N1			•	
		hardenable, hardened	100	340	N2			•	
	Cast aluminium alloys	≤ 12% Si	90	310	N3, N4			•	
		> 12% Si	130	450	N5			•	
	Magnesium alloys		70	250	N6			•	
	Copper and copper alloys (bronze/brass)	non-alloyed, electrolytic copper	100	340	N7			•	
		brass, bronze, red brass	90	310	N8			•	
		Cu-alloys, short-chipping	110	380	N9			•	
		high-strength, Ampco	300	1010	N10			•	
S	Heat-resistant alloys	Fe-based	280	940	S1, S2			••	
		Ni or Co base	250	840	S3			••	
		Ni or Co base	350	1080	S4, S5			••	
	Titanium alloys	pure titanium	200	670	S6			••	
		α and β alloys, hardened	375	1260	S7			••	
		β alloys	410	1400	S8			••	
	Tungsten alloys		300	1010	S9			••	
	Molybdenum alloys		300	1010	S10			••	
H	Hardened steel		50 HRC	–	H1				
			55 HRC	–	H2, H4				
			60 HRC	–	H3				
O	Thermoplasts	without abrasive fillers			O1				
	Thermosetting plastics	without abrasive fillers			O2				
	Plastic, fibre-reinforced	GFRP, AFRP			O3, O5				
		CFRP			O4				
	Graphite (technical)			65	O6				

* The pages indicated in italics refer to the Walter General catalogue 2012.

Ball-nose end mill Proto-max™ Ultra



Materials to 70 HRC

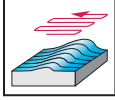

- VHM
- Long reach
- 2 cutting edges
- With centre cut
- 30° helix angle

	P	M	K	N	S	H	O
TAS						●●	

P norm L	D _c h7 mm	R mm	L _c mm	l ₁ mm	l ₄ mm	d ₁ h5 mm	Z	TAS Designation H8004788
Shank DIN 6535 HA	3	1,5	4,5	57	21	6	2	★ -3-57
	3	1,5	4,5	70	34	6	2	★ -3-70
	4	2	6	57	21	6	2	★ -4-57
	4	2	6	70	34	6	2	★ -4-70
	5	2,5	7,5	57	21	6	2	★ -5-57
	5	2,5	7,5	80	44	6	2	★ -5-80
	6	3	9	57	21	6	2	★ -6-57
	6	3	9	90	54	6	2	★ -6-90
	8	4	12	63	27	8	2	★ -8-63
	8	4	12	100	64	8	2	★ -8-100
	10	5	15	72	32	10	2	★ -10-72
	10	5	15	100	60	10	2	★ -10-100
	12	6	18	83	38	12	2	★ -12-83
	12	6	18	110	65	12	2	★ -12-110

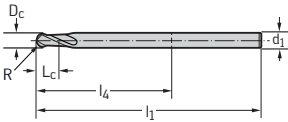

★ New addition to range



B-137

E-91

Mini ball-nose end mill Proto-max™ Ultra



Materials to 70 HRC

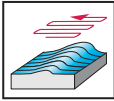

- VHM
- Long reach
- 2 cutting edges
- With centre cut
- 30° helix angle

	P	M	K	N	S	H	O
TAS						●●	

P standard mini	D _c h7 mm	R mm	L _c mm	l ₃ mm	d ₂ mm	l ₁ mm	l ₄ mm	d ₁ h4 mm	Z	TAS Designation H4046988
Shank DIN 6535 HA	0.1	0.05	0.08	0.15	0.08	45	17	4	2	★ -0.1-0.15
	0.1	0.05	0.08	0.3	0.08	45	17	4	2	★ -0.1-0.3
	0.1	0.05	0.08	0.75	0.08	45	17	4	2	★ -0.1-0.75
	0.2	0.1	0.15	0.3	0.17	45	17	4	2	★ -0.2-0.3
	0.2	0.1	0.15	0.6	0.17	45	17	4	2	★ -0.2-0.6
	0.2	0.1	0.15	1	0.17	45	17	4	2	★ -0.2-1
	0.2	0.1	0.15	1.5	0.17	45	17	4	2	★ -0.2-1.5
	0.2	0.1	0.15	2	0.17	45	17	4	2	★ -0.2-2
	0.3	0.15	0.25	0.45	0.27	45	17	4	2	★ -0.3-0.45
	0.3	0.15	0.25	0.9	0.27	45	17	4	2	★ -0.3-0.9
	0.3	0.15	0.25	1.5	0.27	45	17	4	2	★ -0.3-1.5
	0.3	0.15	0.25	2	0.27	45	17	4	2	★ -0.3-2
	0.3	0.15	0.25	3	0.27	45	17	4	2	★ -0.3-3
	0.4	0.2	0.3	0.6	0.37	45	17	4	2	★ -0.4-0.6
	0.4	0.2	0.3	1.2	0.37	45	17	4	2	★ -0.4-1.2
	0.4	0.2	0.3	2	0.37	45	17	4	2	★ -0.4-2
	0.4	0.2	0.3	3	0.37	45	17	4	2	★ -0.4-3
	0.4	0.2	0.3	3.5	0.37	45	17	4	2	★ -0.4-3.5
	0.4	0.2	0.3	4	0.37	45	17	4	2	★ -0.4-4
	0.5	0.25	0.35	0.75	0.47	45	17	4	2	★ -0.5-0.75
	0.5	0.25	0.35	1.5	0.47	45	17	4	2	★ -0.5-1.5
	0.5	0.25	0.35	3	0.47	45	17	4	2	★ -0.5-3
	0.5	0.25	0.35	5	0.47	45	17	4	2	★ -0.5-5
	0.6	0.3	0.4	0.9	0.57	45	17	4	2	★ -0.6-0.9
	0.6	0.3	0.4	1.8	0.57	45	17	4	2	★ -0.6-1.8
	0.6	0.3	0.4	3	0.57	45	17	4	2	★ -0.6-3
	0.6	0.3	0.4	5	0.57	45	17	4	2	★ -0.6-5
	0.6	0.3	0.4	6	0.57	45	17	4	2	★ -0.6-6
	0.8	0.4	0.5	1.2	0.77	45	17	4	2	★ -0.8-1.2
	0.8	0.4	0.5	2.4	0.77	45	17	4	2	★ -0.8-2.4
	0.8	0.4	0.5	4	0.77	45	17	4	2	★ -0.8-4
	0.8	0.4	0.5	6	0.77	45	17	4	2	★ -0.8-6
	1	0.5	0.8	1.5	0.96	45	17	6	2	★ -1-1.5
	1	0.5	0.8	3	0.96	45	17	6	2	★ -1-3
	1	0.5	0.8	6	0.96	45	17	6	2	★ -1-6
	1	0.5	0.8	8	0.96	45	17	6	2	★ -1-8
	1	0.5	0.8	10	0.96	45	17	6	2	★ -1-10
	1.2	0.6	1.1	1.8	1.15	45	17	6	2	★ -1.2-1.8
	1.2	0.6	1.1	3.6	1.15	45	17	6	2	★ -1.2-3.6
	1.5	0.75	1.35	2.25	1.44	45	17	6	2	★ -1.5-2.25
	1.5	0.75	1.35	4.5	1.44	45	17	6	2	★ -1.5-4.5
	1.5	0.75	1.35	8	1.44	45	17	6	2	★ -1.5-8
	1.5	0.75	1.35	12	1.44	45	17	6	2	★ -1.5-12
	2	1	1.7	3	1.92	45	17	6	2	★ -2-3
	2	1	1.7	6	1.92	45	17	6	2	★ -2-6
	2	1	1.7	8	1.92	45	17	6	2	★ -2-8
	2	1	1.7	12	1.92	50	22	6	2	★ -2-12

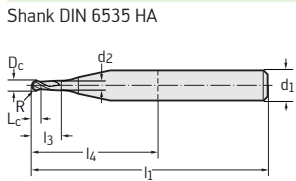

Continued



★ New addition to range

Mini ball-nose end mill Proto-max™ Ultra



Materials to 70 HRC

	P	M	K	N	S	H	O
TAS						●●	

Continued

P standard mini	D _c h7 mm	R mm	L _c mm	l ₃ mm	d ₂ mm	l ₁ mm	l ₄ mm	d ₁ h4 mm	Z	TAS
										Designation H4046988
Shank DIN 6535 HA	2	1	1,7	16	1,92	50	22	6	2	★ -2-16
	2	1	1,7	20	1,92	55	27	6	2	★ -2-20
	2,5	1,25	2,2	3,75	2,42	45	17	6	2	★ -2.5-3.75
	2,5	1,25	2,2	7,5	2,42	45	17	6	2	★ -2.5-7.5
	2,5	1,25	2,2	12,5	2,42	50	22	6	2	★ -2.5-12.5
	2,5	1,25	2,2	15	2,42	50	22	6	2	★ -2.5-15
	2,5	1,25	2,2	20	2,42	55	27	6	2	★ -2.5-20

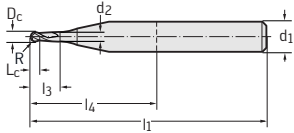

★ New addition to range

Ball-nose end mill Protostar® N 10



Materials to 48 HRC

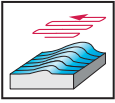

- Solid carbide/spade
- 2 cutting edges
- With centre cut
- 10° helix angle

	P	M	K	N	S	H	O
uncoated				••			
TAX	••	••	•	•			
DIA							••

P standard

ConeFit™

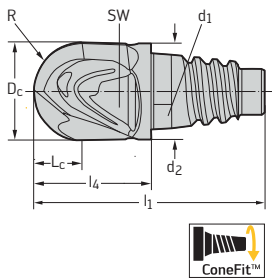

D _c mm	R mm	L _c mm	d ₂ mm	l ₁ mm	l ₄ mm	SW mm	d ₁	Z	uncoated Designation H1E0111	TAX Designation H1E0118	DIA Designation H1E01219
10	5	8	9,7	23	11,8	6	E10	2	★ -E10-10	★ -E10-10	★ -E10-10
12	6	10	11,7	27,8	14	8	E12	2	★ -E12-12	★ -E12-12	★ -E12-12
16	8	13	15,5	35,1	18,1	10	E16	2	★ -E16-16	★ -E16-16	

★ New addition to range

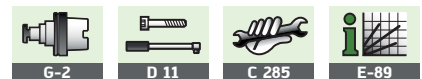

Walter Select – Profile milling

Solid carbide shank cutters

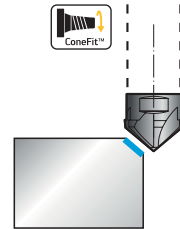
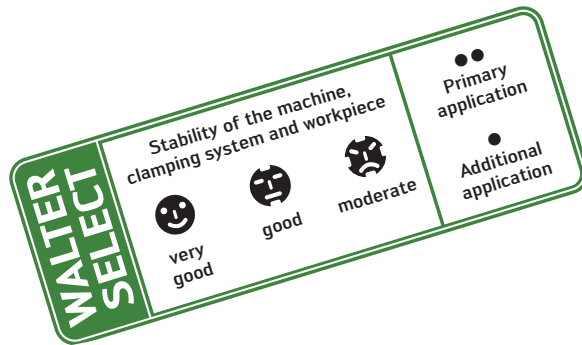
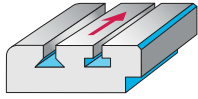

Solid carbide end mills

Material group		Grouping of main material groups and code letters	Workpiece material	Brinell hardness HB	Tensile strength R_m N/mm ²	Machining group	Machining conditions			
							Family	Designation	λ	Page
Machining conditions										
Ø range							10 – 16 NEW			
Number of teeth							4 – 8			
Coating							TAX			
							Family	Designation	λ	Page
							ConeFit™ Chamfer milling cutters			
							60°	H3E58518	0°	<i>E 220*</i>
							90°	H3E58318	0°	<i>E 219*</i>
							120°	H3E58118	0°	<i>E 218*</i>
							ConeFit™ Chamfer milling cutter N 10 Spade			
							60°	H1E58518	10°	E-81
							90°	H1E58318	10°	E-80
							120°	H1E58118	10°	E-79
							150°	H1E58018	10°	E-78
P	Non-alloyed and low-alloyed steel	annealed (tempered)	210	700	P1, P2, P3, P4, P7	●●				
		free cutting steel	220	750	P6	●●				
		tempered	300	1010	P5, P8	●●				
		tempered	380	1280	P9	●●				
		tempered	430	1480	P10	●●				
	High-alloyed steel and high-alloyed tool steel	annealed	200	670	P11	●●				
		hardened and tempered	300	1010	P12	●●				
		hardened and tempered	400	1360	P13	●●				
	Stainless steel	ferritic/martensitic, annealed	200	670	P14	●●				
		martensitic, tempered	330	1110	P15	●●				
M	Stainless steel	austenitic, duplex	230	780	M1, M3	●●				
		austenitic, precipitation hardened (PH)	300	1010	M2	●●				
K	Grey cast iron		245	–	K3, K4	●				
	Cast iron with spheroidal graphite	ferritic, pearlitic	365	–	K1, K2, K5, K6	●				
	GGV (CGI)		200	–	K7	●				
N	Aluminium wrought alloys	cannot be hardened	30	–	N1	●				
		hardenable, hardened	100	340	N2	●				
	Cast aluminium alloys	≤ 12% Si	90	310	N3, N4	●				
		> 12% Si	130	450	N5	●				
	Magnesium alloys		70	250	N6	●				
	Copper and copper alloys (bronze/brass)	non-alloyed, electrolytic copper	100	340	N7	●				
		brass, bronze, red brass	90	310	N8	●				
		Cu-alloys, short-chipping	110	380	N9	●				
		high-strength, Ampco	300	1010	N10	●				
S	Heat-resistant alloys	Fe-based	280	940	S1, S2	●				
		Ni or Co base	250	840	S3	●				
		Ni or Co base	350	1080	S4, S5	●				
	Titanium alloys	pure titanium	200	670	S6	●				
		α and β alloys, hardened	375	1260	S7	●				
		β alloys	410	1400	S8	●				
Tungsten alloys		300	1010	S9	●					
Molybdenum alloys		300	1010	S10	●					
H	Hardened steel		50 HRC	–	H1	●				
			55 HRC	–	H2, H4					
			60 HRC	–	H3					
O	Thermoplasts	without abrasive fillers			O1	●				
	Thermosetting plastics	without abrasive fillers			O2	●				
	Plastic, fibre-reinforced	GFRP, AFRP			O3, O5					
		CFRP			O4					
Graphite (technical)			65	O6						

* The pages indicated in italics refer to the Walter General catalogue 2012.

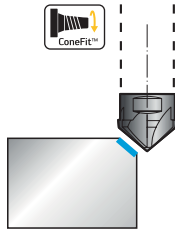

Solid carbide end mills

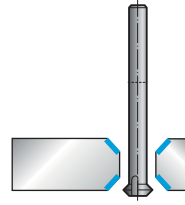

Solid carbide end mills

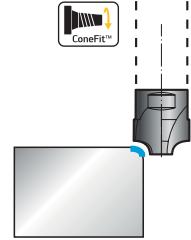

Solid carbide end mills

6 - 12				6 - 12				6 - 12				6 - 20				
3 - 6				4 - 6				3 - 6				4				
TAX				uncoated				TAX				TAX				
Family	Designation	λ	Page	Family	Designation	λ	Page	Family	Designation	λ	Page	Family	Designation	λ	Page	
Chamfer milling cutters 60°	H3058518	0°	<i>E 220*</i>	Chamfer milling cutters 60°	H305851	0°	<i>E 220*</i>	Forward/backward deburrer	H3053918	0°	<i>E 221*</i>	ConeFit™ Quarter-round milling cutter	H3E68118	0°	<i>E 222*</i>	
	H3158518	0°			H305831	0°	<i>E 219*</i>						Quarter-round milling cutter	H3068118	0°	<i>E 222*</i>
	H3058318	0°	<i>E 219*</i>		H305811	0°	<i>E 218*</i>									
90°	H3058318	0°	<i>E 219*</i>	90°	H305831	0°	<i>E 219*</i>									
120°	H3058118	0°	<i>E 218*</i>	120°	H305811	0°	<i>E 218*</i>									

Walter Select – Profile milling

HSS T-slot milling cutters

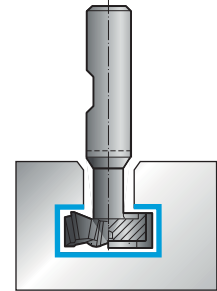
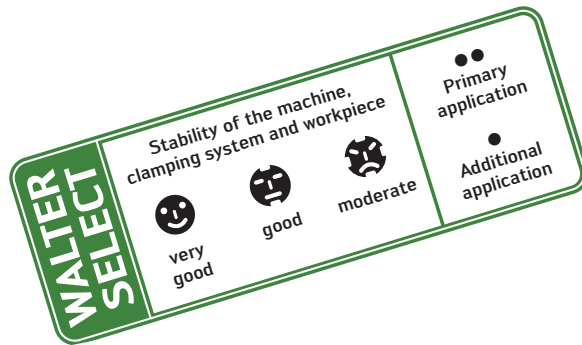
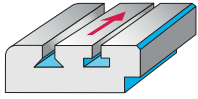

T-slot milling cutter

Material group	Grouping of main material groups and code letters	Workpiece material	Brinell hardness HB	Tensile strength R_m N/mm ²	Machining group	Machining conditions			
						Family	Designation	λ	Page
						Machining conditions:			
						\emptyset range: 11 – 40			
						Number of teeth: 6 – 10			
						Coating: TiCN			
						N 12	P3148016	12°	<i>E 223*</i>
P	Non-alloyed and low-alloyed steel	annealed (tempered)	210	700	P1, P2, P3, P4, P7	••			
		free cutting steel	220	750	P6	••			
		tempered	300	1010	P5, P8	••			
		tempered	380	1280	P9	••			
		tempered	430	1480	P10	••			
	High-alloyed steel and high-alloyed tool steel	annealed	200	670	P11	••			
		hardened and tempered	300	1010	P12	••			
		hardened and tempered	400	1360	P13	••			
	Stainless steel	ferritic/martensitic, annealed	200	670	P14	••			
		martensitic, tempered	330	1110	P15	••			
M	Stainless steel	austenitic, duplex	230	780	M1, M3	•			
		austenitic, precipitation hardened (PH)	300	1010	M2	•			
K	Grey cast iron		245	–	K3, K4	••			
	Cast iron with spheroidal graphite	ferritic, pearlitic	365	–	K1, K2, K5, K6	••			
	GGV (CGI)		200	–	K7	••			
N	Aluminium wrought alloys	cannot be hardened	30	–	N1	•			
		hardenable, hardened	100	340	N2	•			
	Cast aluminium alloys	≤ 12% Si	90	310	N3, N4	•			
		> 12% Si	130	450	N5	•			
	Magnesium alloys		70	250	N6	•			
	Copper and copper alloys (bronze/brass)	non-alloyed, electrolytic copper	100	340	N7	•			
		brass, bronze, red brass	90	310	N8	•			
		Cu-alloys, short-chipping	110	380	N9	•			
		high-strength, Ampco	300	1010	N10	•			
S	Heat-resistant alloys	Fe-based	280	940	S1, S2				
		Ni or Co base	250	840	S3				
		Ni or Co base	350	1080	S4, S5				
	Titanium alloys	pure titanium	200	670	S6				
		α and β alloys, hardened	375	1260	S7				
		β alloys	410	1400	S8				
	Tungsten alloys		300	1010	S9				
	Molybdenum alloys		300	1010	S10				
H	Hardened steel		50 HRC	–	H1				
			55 HRC	–	H2, H4				
			60 HRC	–	H3				
O	Thermoplasts	without abrasive fillers			O1				
	Thermosetting plastics	without abrasive fillers			O2				
	Plastic, fibre-reinforced	GFRP, AFRP			O3, O5				
		CFRP			O4				
	Graphite (technical)			65	O6				

* The pages indicated in italics refer to the Walter General catalogue 2012.

Walter Select – Profile milling

HSS, T-slot, quarter-round, dovetail milling cutters

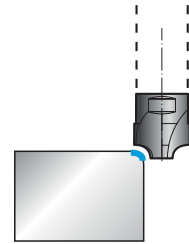
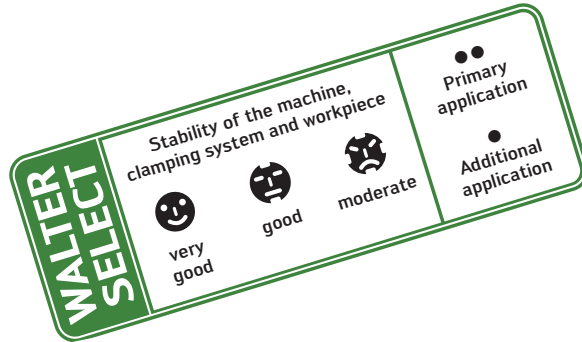
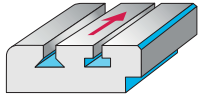

Quarter-round milling cutter

Machining conditions			
Ø range	8 – 20		
Number of teeth	4 – 6		
Coating	uncoated		
	Designation	λ	Page

Material group	Grouping of main material groups and code letters		Brinell hardness HB	Tensile strength R _m N/mm ²	Machining group	Designation	λ	Page
	Workpiece material							
P	Non-alloyed and low-alloyed steel	annealed (tempered)	210	700	P1, P2, P3, P4, P7	●	0°	<i>E 226*</i>
		free cutting steel	220	750	P6			
		tempered	300	1010	P5, P8			
		tempered	380	1280	P9			
		tempered	430	1480	P10			
	High-alloyed steel and high-alloyed tool steel	annealed	200	670	P11			
		hardened and tempered	300	1010	P12			
hardened and tempered		400	1360	P13				
Stainless steel	ferritic/martensitic, annealed	200	670	P14				
	martensitic, tempered	330	1110	P15				
M	Stainless steel	austenitic, duplex	230	780	M1, M3			
		austenitic, precipitation hardened (PH)	300	1010	M2			
K	Grey cast iron		245	–	K3, K4			
	Cast iron with spheroidal graphite	ferritic, pearlitic	365	–	K1, K2, K5, K6			
	GGV (CGI)		200	–	K7			
N	Aluminium wrought alloys	cannot be hardened	30	–	N1			
		hardenable, hardened	100	340	N2			
	Cast aluminium alloys	≤ 12% Si	90	310	N3, N4			
		> 12% Si	130	450	N5			
	Magnesium alloys		70	250	N6			
	Copper and copper alloys (bronze/brass)	non-alloyed, electrolytic copper	100	340	N7			
		brass, bronze, red brass	90	310	N8			
Cu-alloys, short-chipping		110	380	N9				
high-strength, Ampco		300	1010	N10				
S	Heat-resistant alloys	Fe-based	280	940	S1, S2			
		Ni or Co base	250	840	S3			
		Ni or Co base	350	1080	S4, S5			
	Titanium alloys	pure titanium	200	670	S6			
		α and β alloys, hardened	375	1260	S7			
		β alloys	410	1400	S8			
	Tungsten alloys		300	1010	S9			
Molybdenum alloys		300	1010	S10				
H	Hardened steel		50 HRC	–	H1			
			55 HRC	–	H2, H4			
			60 HRC	–	H3			
O	Thermoplasts	without abrasive fillers			O1			
	Thermosetting plastics	without abrasive fillers			O2			
	Plastic, fibre-reinforced	GFRP, AFRP				O3, O5		
		CFRP				O4		
	Graphite (technical)			65		O6		

* The pages indicated in italics refer to the Walter General catalogue 2012.

Chamfer milling cutter 120° Protostar® N 10



Materials to 48 HRC

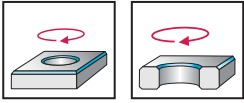

- Solid carbide/spade
- 2 cutting edges
- With centre cut
- 10° helix angle

Special features:
Shoulder milling: $a_e \leq 0.5 \times D_c$

	P	M	K	N	S	H	O
TAX	●●	●	●	●	●		

P standard	D_a mm	α	L_c mm	d_2 mm	l_1 mm	l_4 mm	SW mm	d_1 mm	Z	TAX
										Designation H1E58118
ConeFit™	10	120°	2,7	9,7	23	11,8	6	E10	2	★ -E10-10
	12	120°	3,3	11,7	27,8	14	8	E12	2	★ -E12-12

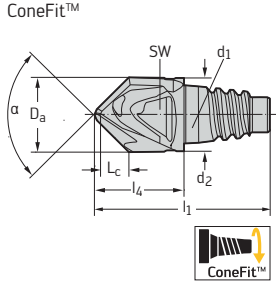

★ New addition to range

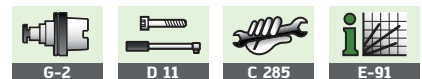

Chamfer milling cutter 60° Protostar® N 10



Materials to 48 HRC

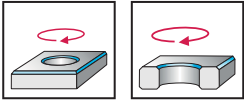

- Solid carbide/spade
- 2 cutting edges
- With centre cut
- 10° helix angle

Special features:
Shoulder milling: $a_e \leq 0.5 \times D_c$

	P	M	K	N	S	H	O
TAX	●●	●	●	●	●		

P standard	D _a mm	α	L _c mm	d ₂ mm	l ₁ mm	l ₄ mm	SW mm	d ₁ mm	Z	TAX
										Designation H1E58518
ConeFit™	10	60°	7,5	9,7	23	11,8	6	E10	2	★ -E10-10
	12	60°	8	11,7	27,8	14	8	E12	2	★ -E12-12

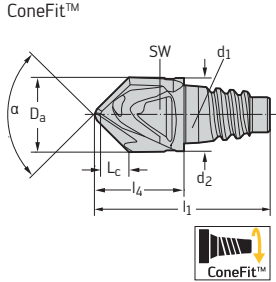

★ New addition to range

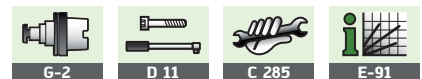

Cutting data for shoulder milling

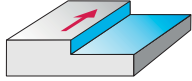

The specified cutting data are average recommended values.
For special applications, adjustment is recommended.

Cutting tool material	VHM			
	Family	Des.	λ	Page
	N 50	H3023138	50°	E-13

Material group	Grouping of main material groups and code letters		Brinell hardness HB	Tensile strength R_{m} N/mm ²	Machining group ¹	Ø 6 – 25					
						Z = 6 – 8					
	Workpiece material					TAX			1/2	a_e / D_c	
1/4			1/10								
P	Non-alloyed steel	C ≤ 0.25%	annealed	125	428	P1		240	290	A	
		C > 0.25... ≤ 0.55%	annealed	190	639	P2		230	280	A	
		C > 0.25... ≤ 0.55%	tempered	210	708	P3		200	240	A	
		C > 0.55%	annealed	190	639	P4		200	240	A	
		C > 0.55%	tempered	300	1013	P5		140	170	A	
		free cutting steel (short-chipping)	annealed	220	745	P6		200	240	A	
	Low-alloyed steel		annealed		175	591	P7		200	240	A
			tempered		300	1013	P8		140	170	A
			tempered		380	1282	P9		120	140	A
			tempered		430	1477	P10		100	120	A
	High-alloyed steel and high-alloyed tool steel		annealed		200	675	P11		200	240	A
			hardened and tempered		300	1013	P12		140	170	A
			hardened and tempered		400	1361	P13		100	120	A
	Stainless steel		ferritic/martensitic, annealed		200	675	P14		70	80	A
			martensitic, tempered		330	1114	P15		50	60	A
M	Stainless steel	austenitic, quench hardened		200	675	M1		80	100	B	
		austenitic, precipitation hardened (PH)		300	1013	M2		50	60	B	
		austenitic/ferritic, duplex		230	778	M3		70	80	B	
K	Malleable cast iron	ferritic		200	675	K1					
		pearlitic		260	867	K2					
	Grey cast iron	Low tensile strength		180	602	K3					
		high tensile strength/austenitic		245	825	K4					
	Cast iron with spheroidal graphite	ferritic		155	518	K5					
		pearlitic		265	885	K6					
GGV (CGI)			200	675	K7						
N	Aluminium wrought alloys	cannot be hardened		30	–	N1					
		hardenable, hardened		100	343	N2					
	Cast aluminium alloys	≤ 12% Si, cannot be hardened		75	260	N3					
		≤ 12% Si, hardenable, hardened		90	314	N4					
		> 12% Si, cannot be hardened		130	447	N5					
	Magnesium alloys			70	250	N6					
	Copper and copper alloys (bronze/brass)	non-alloyed, electrolytic copper		100	343	N7					
brass, bronze, red brass			90	314	N8						
Cu-alloys, short-chipping			110	382	N9						
high-strength, Ampco			300	1013	N10						
S	Heat-resistant alloys	Fe-based	annealed		200	675	S1		60	80	B
			hardened		280	943	S2		40	50	B
		Ni or Co base	annealed		250	839	S3		60	80	B
			hardened		350	1177	S4		40	50	B
			cast		320	1076	S5		40	50	B
	Titanium alloys	pure titanium		200	675	S6					
		α and β alloys, hardened		375	1262	S7		60	80	B	
		β alloys		410	1396	S8		60	80	B	
	Tungsten alloys			300	1013	S9		70	90	B	
	Molybdenum alloys			300	1013	S10					
H	Hardened steel	hardened and tempered		50 HRC	–	H1					
		hardened and tempered		55 HRC	–	H2					
		hardened and tempered		60 HRC	–	H3					
	Hardened cast iron	hardened and tempered		55 HRC	–	H4					
O	Thermoplasts	without abrasive fillers				O1					
	Thermosetting plastics	without abrasive fillers				O2					
	Plastic, glass-fibre reinforced	GFRP				O3					
	Plastic, carbon-fibre reinforced	CFRP				O4					
	Plastic, aramid-fibre reinforced	AFRP				O5					
	Graphite (technical)			80 Shore			O6				

¹ The classification of the machining groups can be found in the Walter General catalogue 2012 from page H 8 onwards.

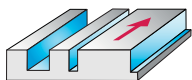

Cutting data for shoulder/slot milling

VHM															
Family				Des.				λ				Page			
ConeFit™				H4E34217				50°				E-38			
Proto-max™ _{ST}				H4E38217				E-48				Proto-max™ _{ST}			
Proto-max™ _{ST}				H4034217				50°							
Proto-max™ _{ST}				H4134217				E-39				Proto-max™ _{ST}			
Proto-max™ _{ST}				H4038217				E-49							
Proto-max™ _{ST}				H4138217				E-49							
Ø 3 – 20				Ø 2 – 20				Ø 10 – 25				Ø 10 – 20			
Z = 4				Z = 3				Z = 4 – 5				Z = 4			
TAZ				TAZ				TAA				TAA			
1/1	a_e / D_c		VT	1/1	a_e / D_c		VT	1/1	a_e / D_c		VT	1/1	a_e / D_c		VT
	1/2	1/10	1/2		1/10	1/2	1/10		1/2	1/10	1/2		1/10		
220	230	320	F	220	230	320	F								
140	190	230	F	140	190	230	F								
110	130	190	F	110	130	190	F								
90	110	150	F	90	110	150	F								
200	230	320	F	200	230	320	F								
140	190	230	F	140	190	230	F								
								90	130	180	M	80	110	160	D
								70	100	140	M	65	90	130	D
								50	80	100	M	40	60	90	D

Cutting data for shoulder/slot milling

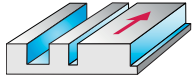

The specified cutting data are average recommended values.
For special applications, adjustment is recommended.

Cutting tool material	VHM			
	Family	Des.	λ	Page
	Proto-max™ Inox	H2034217	35°/38°	E-42
		H2134217		E-42
		H2038217		E-52
		H2138217		E-52

Material group	Grouping of main material groups and code letters		Brinell hardness HB	Tensile strength R _m N/mm ²	Machining group ¹	Ø 6 – 25				
						Z = 4 – 5				
	Workpiece material					TAA			VT	
a _e / D _c			1/1	1/2	1/10					
P	Non-alloyed steel	C ≤ 0.25%	annealed	125	428	P1				
		C > 0.25... ≤ 0.55%	annealed	190	639	P2				
		C > 0.25... ≤ 0.55%	tempered	210	708	P3				
		C > 0.55%	annealed	190	639	P4				
		C > 0.55%	tempered	300	1013	P5				
		free cutting steel (short-chipping)	annealed	220	745	P6				
	Low-alloyed steel		annealed	175	591	P7				
			tempered	300	1013	P8				
			tempered	380	1282	P9				
			tempered	430	1477	P10				
	High-alloyed steel and high-alloyed tool steel		annealed	200	675	P11				
			hardened and tempered	300	1013	P12				
			hardened and tempered	400	1361	P13				
	Stainless steel		ferritic/martensitic, annealed	200	675	P14				
			martensitic, tempered	330	1114	P15				
M	Stainless steel	austenitic, quench hardened		200	675	M1	80	110	160	M
		austenitic, precipitation hardened (PH)		300	1013	M2	70	100	140	M
		austenitic/ferritic, duplex		230	778	M3	50	80	100	M
K	Malleable cast iron	ferritic		200	675	K1				
		pearlitic		260	867	K2				
	Grey cast iron	Low tensile strength		180	602	K3				
		high tensile strength/austenitic		245	825	K4				
	Cast iron with spheroidal graphite	ferritic		155	518	K5				
		pearlitic		265	885	K6				
GGV (CGI)			200	675	K7					
N	Aluminium wrought alloys	cannot be hardened		30	–	N1				
		hardenable, hardened		100	343	N2				
	Cast aluminium alloys	≤ 12% Si, cannot be hardened		75	260	N3				
		≤ 12% Si, hardenable, hardened		90	314	N4				
		> 12% Si, cannot be hardened		130	447	N5				
	Magnesium alloys			70	250	N6				
	Copper and copper alloys (bronze/brass)	non-alloyed, electrolytic copper		100	343	N7				
brass, bronze, red brass			90	314	N8					
Cu-alloys, short-chipping			110	382	N9					
high-strength, Ampco			300	1013	N10					
S	Heat-resistant alloys	Fe-based	annealed	200	675	S1	25	35	55	M
			hardened	280	943	S2	25	35	55	M
		Ni or Co base	annealed	250	839	S3	25	35	55	M
			hardened	350	1177	S4	25	35	55	M
			cast	320	1076	S5	25	35	55	M
	Titanium alloys	pure titanium		200	675	S6				
		α and β alloys, hardened		375	1262	S7				
		β alloys		410	1396	S8				
	Tungsten alloys			300	1013	S9	25	35	55	M
	Molybdenum alloys			300	1013	S10	25	35	55	M
H	Hardened steel	hardened and tempered		50 HRC	–	H1				
		hardened and tempered		55 HRC	–	H2				
		hardened and tempered		60 HRC	–	H3				
	Hardened cast iron	hardened and tempered		55 HRC	–	H4				
O	Thermoplasts	without abrasive fillers				O1				
	Thermosetting plastics	without abrasive fillers				O2				
	Plastic, glass-fibre reinforced	GFRP				O3				
	Plastic, carbon-fibre reinforced	CFRP				O4				
	Plastic, aramid-fibre reinforced	AFRP				O5				
	Graphite (technical)			80 Shore			O6			

¹ The classification of the machining groups can be found in the Walter General catalogue 2012 from page H 8 onwards.

Cutting data for shoulder/slot milling

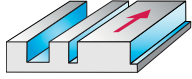

The specified cutting data are average recommended values.
For special applications, adjustment is recommended.

Cutting tool material	VHM			
	Family	Des.	λ	Page
ConeFit™ N 50 for graphite	H3E20419	50°	E-57	

Material group	Grouping of main material groups and code letters		Brinell hardness HB	Tensile strength R _m N/mm ²	Machining group ¹	Ø 10 - 12				
						Z = 4				
	Workpiece material					DIA				
1/1			a _e /D _c 1/2	1/10	VT					
P	Non-alloyed steel	C ≤ 0.25%	annealed	125	428	P1				
		C > 0.25... ≤ 0.55%	annealed	190	639	P2				
		C > 0.25... ≤ 0.55%	tempered	210	708	P3				
		C > 0.55%	annealed	190	639	P4				
		C > 0.55%	tempered	300	1013	P5				
		free cutting steel (short-chipping)	annealed	220	745	P6				
	Low-alloyed steel		annealed	175	591	P7				
			tempered	300	1013	P8				
			tempered	380	1282	P9				
			tempered	430	1477	P10				
	High-alloyed steel and high-alloyed tool steel		annealed	200	675	P11				
			hardened and tempered	300	1013	P12				
			hardened and tempered	400	1361	P13				
	Stainless steel		ferritic/martensitic, annealed	200	675	P14				
			martensitic, tempered	330	1114	P15				
M	Stainless steel		austenitic, quench hardened	200	675	M1				
			austenitic, precipitation hardened (PH)	300	1013	M2				
			austenitic/ferritic, duplex	230	778	M3				
K	Malleable cast iron		ferritic	200	675	K1				
			pearlitic	260	867	K2				
	Grey cast iron		Low tensile strength	180	602	K3				
			high tensile strength/austenitic	245	825	K4				
	Cast iron with spheroidal graphite		ferritic	155	518	K5				
			pearlitic	265	885	K6				
	GGV (CGI)		200	675	K7					
N	Aluminium wrought alloys		cannot be hardened	30	–	N1				
			hardenable, hardened	100	343	N2				
	Cast aluminium alloys		≤ 12% Si, cannot be hardened	75	260	N3				
			≤ 12% Si, hardenable, hardened	90	314	N4				
			> 12% Si, cannot be hardened	130	447	N5				
	Magnesium alloys		70	250	N6					
	Copper and copper alloys (bronze/brass)		non-alloyed, electrolytic copper	100	343	N7				
		brass, bronze, red brass	90	314	N8					
		Cu-alloys, short-chipping	110	382	N9					
		high-strength, Ampco	300	1013	N10					
S	Heat-resistant alloys	Fe-based	annealed	200	675	S1				
			hardened	280	943	S2				
		Ni or Co base	annealed	250	839	S3				
			hardened	350	1177	S4				
			cast	320	1076	S5				
	Titanium alloys		pure titanium	200	675	S6				
			α and β alloys, hardened	375	1262	S7				
			β alloys	410	1396	S8				
	Tungsten alloys		300	1013	S9					
	Molybdenum alloys		300	1013	S10					
H	Hardened steel		hardened and tempered	50 HRC	–	H1				
			hardened and tempered	55 HRC	–	H2				
			hardened and tempered	60 HRC	–	H3				
	Hardened cast iron		hardened and tempered	55 HRC	–	H4				
O	Thermoplasts		without abrasive fillers			O1				
	Thermosetting plastics		without abrasive fillers			O2				
	Plastic, glass-fibre reinforced		GFRP			O3				
	Plastic, carbon-fibre reinforced		CFRP			O4				
	Plastic, aramid-fibre reinforced		AFRP			O5				
	Graphite (technical)		80 Shore			O6	900	900	1300	C

¹ The classification of the machining groups can be found in the Walter General catalogue 2012 from page H 8 onwards.

Cutting data for copy milling

VHM															
Family	Des.	λ	Page	Family	Des.	λ	Page	Family	Des.	λ	Page	Family	Des.	λ	Page
ConeFit™ Spade N 10	H1E12018	10°	E-56	Qmax HR Kordel F 45	H3186378	45°	E-59	Qmax HR Kordel F 40	H3183378	40°	E-60	ConeFit™ Spade N 10	H1E0111	10°	E-71
Ø 10 – 16				Ø 12 – 20				Ø 6 – 20				Ø 10 – 16			
Z = 2				Z = 5 + 6				Z = 4				Z = 2			
TAX				TAX				TAX				uncoated			
		a_e / D_c				VT				a_e / D_c				VT	
1/1	1/2	1/10		1/1	1/2	1/10		1/1	1/2	1/10		1/5	1/20	1/50	VT
	350	490	D	160	210	310	A	160	210	300	A	430	500	700	A
	320	460	D	160	210	290	A	160	200	290	A	410	560	680	A
	380	540	D	130	180	250	A	130	170	250	A	410	560	680	A
	250	360	D	130	180	250	A	130	170	250	A	410	560	680	A
	250	360	D	90	120	180	A	90	120	180	A	330	450	540	A
	310	450	D	130	180	250	A	130	170	250	A	430	580	700	A
	230	330	D	130	180	250	A	130	170	250	A	410	560	680	A
	250	350	D	90	120	180	A	90	120	180	A	370	510	610	A
	220	320	D									265	360	440	A
	230	330	D									370	510	610	A
	260	370	D	130	180	250	A	130	170	250	A	300	400	490	A
	250	360	D	90	120	180	A	90	120	180	A	330	450	540	A
	220	320	D									140	190	230	A
	150	210	D	50	60	90	A	50	60	90	A	130	170	210	A
	60	80	D				A				A	155	210	260	A
	95	145	D	60	70	110	B	60	70	100	B	180	250	300	B
	85	120	D									155	170	200	B
	60	80	D	35	60	80	B	35	60	80	B	125	170	200	B
	250	360	D	120	160	230	A	120	160	230	A	330	450	540	A
	200	290	D	100	130	180	A	100	130	180	A	330	450	540	A
	300	430	D	120	160	230	A	120	160	230	A	350	475	570	A
	230	320	D	100	140	200	A	100	140	200	A	350	475	570	A
	260	360	D	120	160	230	A	120	160	230	A	330	450	540	A
	200	290	D	100	130	180	A	100	130	180	A	330	450	540	A
	180	250	D	80	110	160	A	90	110	160	A	330	450	540	A
												1040	880	880	C
												1040	880	880	C
												530	720	870	C
												530	720	870	C
															C
												1040	880	880	C
												970	1140	880	C
												970	1140	880	C
												970	1140	880	C
												140	185	220	C
												390	570	720	B
												65	95	120	B
												68	100	125	B
												69	100	125	B
												69	100	125	B
												390	570	720	B
												140	230	300	B
												69	100	300	B
												69	100	300	B
												69	100	300	B
												140	190	230	B
												130	180	210	B
												370	510	610	B

Cutting data for copy milling

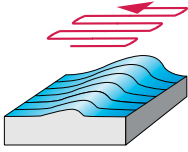

The specified cutting data are average recommended values.
For special applications, adjustment is recommended.

Cutting tool material	VHM			
	Family	Des.	λ	Page
ConeFit™ Spade N 10	H1E01118	10°	E-71	

Material group	Grouping of main material groups and code letters		Brinell hardness HB	Tensile strength R _m N/mm ²	Machining group ¹	Ø 10 – 16					
						Z = 2					
	Workpiece material					TAX					
a _e / D _c			VT								
			1/5	1/20	1/50						
P	Non-alloyed steel	C ≤ 0.25%	annealed	125	428	P1	430	500	700	A	
		C > 0.25... ≤ 0.55%	annealed	190	639	P2	410	560	680	A	
		C > 0.25... ≤ 0.55%	tempered	210	708	P3	410	560	680	A	
		C > 0.55%	annealed	190	639	P4	410	560	680	A	
		C > 0.55%	tempered	300	1013	P5	330	450	540	A	
		free cutting steel (short-chipping)	annealed	220	745	P6	430	580	700	A	
	Low-alloyed steel		annealed	175	591	P7	410	560	680	A	
			tempered	300	1013	P8	370	510	610	A	
			tempered	380	1282	P9	265	360	440	A	
			tempered	430	1477	P10	370	510	610	A	
	High-alloyed steel and high-alloyed tool steel		annealed	200	675	P11	300	400	490	A	
			hardened and tempered	300	1013	P12	330	450	540	A	
			hardened and tempered	400	1361	P13	140	190	230	A	
	Stainless steel		ferritic/martensitic, annealed	200	675	P14	130	170	210	A	
			martensitic, tempered	330	1114	P15	155	210	260	A	
M	Stainless steel	austenitic, quench hardened		200	675	M1	180	250	300	B	
		austenitic, precipitation hardened (PH)		300	1013	M2	155	170	200	B	
		austenitic/ferritic, duplex		230	778	M3	125	170	200	B	
K	Malleable cast iron	ferritic		200	675	K1	330	450	540	A	
		pearlitic		260	867	K2	330	450	540	A	
	Grey cast iron	Low tensile strength		180	602	K3	350	475	570	A	
		high tensile strength/austenitic		245	825	K4	350	475	570	A	
	Cast iron with spheroidal graphite	ferritic		155	518	K5	330	450	540	A	
		pearlitic		265	885	K6	330	450	540	A	
GGV (CGI)			200	675	K7	330	450	540	A		
N	Aluminium wrought alloys	cannot be hardened		30	–	N1	1040	880	880	C	
		hardenable, hardened		100	343	N2	1040	880	880	C	
	Cast aluminium alloys	≤ 12% Si, cannot be hardened		75	260	N3	530	720	870	C	
		≤ 12% Si, hardenable, hardened		90	314	N4	530	720	870	C	
		> 12% Si, cannot be hardened		130	447	N5				C	
	Magnesium alloys			70	250	N6	1040	880	880	C	
	Copper and copper alloys (bronze/brass)		non-alloyed, electrolytic copper		100	343	N7	970	1140	880	C
		brass, bronze, red brass		90	314	N8	970	1140	880	C	
		Cu-alloys, short-chipping		110	382	N9	970	1140	880	C	
		high-strength, Ampco		300	1013	N10	140	185	220	C	
S	Heat-resistant alloys	Fe-based	annealed		200	675	S1	390	570	720	B
			hardened		280	943	S2	65	95	120	B
		Ni or Co base	annealed		250	839	S3	68	100	125	B
			hardened		350	1177	S4	69	100	125	B
			cast		320	1076	S5	69	100	125	B
	Titanium alloys		pure titanium		200	675	S6	390	570	720	B
			α and β alloys, hardened		375	1262	S7	140	230	300	B
			β alloys		410	1396	S8	69	100	300	B
	Tungsten alloys			300	1013	S9	69	100	300	B	
	Molybdenum alloys			300	1013	S10	69	100	300	B	
H	Hardened steel		hardened and tempered		50 HRC	–	H1	140	190	230	B
			hardened and tempered		55 HRC	–	H2	130	180	210	B
			hardened and tempered		60 HRC	–	H3				
Hardened cast iron			hardened and tempered		55 HRC	–	H4	370	510	610	B
O	Thermoplasts									O1	
	Thermosetting plastics									O2	
	Plastic, glass-fibre reinforced									O3	
	Plastic, carbon-fibre reinforced									O4	
	Plastic, aramid-fibre reinforced									O5	
	Graphite (technical)				80 Shore						O6

¹ The classification of the machining groups can be found in the Walter General catalogue 2012 from page H 8 onwards.

Cutting data for profile milling

VHM															
Family Des. λ Page				Family Des. λ Page				Family Des. λ Page				Family Des. λ Page			
ConeFit™ Spade N 10 H1E01219 10° E-71				Proto-max™ Ultra standard H8004788 30° E-68				Proto-max™ Ultra mini H4046988 30° E-69				ConeFit™ Spade Chamfer milling cutters H1E58018 10° E-78 H1E58118 10° E-79 H1E58318 10° E-80 H1E58518 10° E-81			
Ø 10 + 12				Ø 3 – 12				Ø 0,1 – 2,5				Ø 10 – 16			
Z = 2				Z = 2				Z = 2				Z = 2			
DIA				TAS				TAS				TAX			
a _e / D _c		VT		a _e / D _c		VT		a _e / D _c		VT		a _e / D _c		VT	
1/5	1/20	1/50		1/5	1/20	1/50		1/5	1/20	1/50		1/3	1/10	1/20	
												220	320	380	A
												220	320	380	A
												180	260	320	A
												180	260	320	A
												130	180	230	A
												180	260	320	A
												180	260	320	A
												130	180	230	A
												110	150	170	A
												90	130	160	A
												180	260	320	A
												130	180	230	A
												90	130	160	A
												60	90	110	A
												50	70	80	A
												80	110	130	B
												50	70	80	B
												60	90	110	B
												170	240	300	A
												130	190	230	A
												170	240	300	A
												170	240	300	A
												170	240	300	A
												130	190	230	A
												110	160	200	A
												1600	2300	2900	C
												1600	2300	2900	C
												260	370	450	C
												260	370	450	C
												170	240	300	C
												750	1100	1300	C
												480	680	840	C
												480	680	840	C
												480	680	840	C
												70	100	120	C
												60	90	110	B
												40	50	70	B
												60	90	110	B
												40	50	70	B
												40	50	70	B
												200	290	370	B
												60	90	120	B
												60	90	120	B
												70	100	120	B
												70	100	120	B
						160	220	260				160	220	260	
						160	220	260				160	220	260	
						160	220	260				160	220	260	
												380	550	670	C
	1.000	1.000	1.400												
				C											

Feed matrices – f_z table

The specified feed rates are average recommended values.
For special applications, adjustment is recommended.

A Material groups ISO P, ISO K and titanium alloys

Feed per tooth f_z [mm]											
a_e [mm]*	Ø 0.3 mm	Ø 0.5 mm	Ø 1 mm	Ø 2 mm	Ø 3 mm	Ø 4 mm	Ø 6 mm	Ø 8 mm	Ø 10 mm	Ø 12 mm	Ø 14 mm
0,01	0,02	0,02	0,03	0,06	0,09	0,12	0,15	0,15	0,20		
0,05	0,01	0,01	0,02	0,04	0,07	0,10	0,12	0,15	0,20		
0,1	0,01	0,01	0,02	0,03	0,05	0,08	0,10	0,15	0,20	0,20	0,20
0,2	0,01	0,01	0,01	0,03	0,04	0,06	0,08	0,15	0,18	0,20	0,20
0,5		0,01	0,01	0,02	0,03	0,05	0,07	0,12	0,15	0,15	0,15
1			0,01	0,02	0,03	0,04	0,06	0,09	0,12	0,12	0,12
2				0,02	0,03	0,03	0,05	0,08	0,11	0,12	0,12
3					0,02	0,02	0,04	0,07	0,10	0,12	0,12
5						0,02	0,04	0,07	0,10	0,12	0,12
6							0,03	0,06	0,08	0,10	0,10
8								0,05	0,07	0,09	0,10
10									0,06	0,08	0,10
12										0,07	0,09
14											0,08
16											
18											
20											
25											
32											
40											
50											
63											
80											
100											
160											
200											

A Material groups ISO P, ISO K and titanium alloys

Feed per tooth f_z [mm]												
a_e [mm]*	Ø 16 mm	Ø 18 mm	Ø 20 mm	Ø 25 mm	Ø 32 mm	Ø 40 mm	Ø 50 mm	Ø 63 mm	Ø 80 mm	Ø 100 mm	Ø 160 mm	Ø 200 mm
0,01												
0,05												
0,1	0,20											
0,2	0,20	0,20	0,25									
0,5	0,15	0,20	0,25	0,25								
1	0,12	0,15	0,20	0,25	0,25	0,30	0,30	0,30	0,40	0,40	0,50	0,50
2	0,12	0,15	0,20	0,20	0,25	0,25	0,25	0,30	0,30	0,40	0,40	0,40
3	0,12	0,14	0,18	0,20	0,20	0,25	0,25	0,25	0,30	0,30	0,40	0,40
5	0,12	0,12	0,15	0,20	0,20	0,20	0,25	0,25	0,25	0,30	0,30	0,30
6	0,12	0,12	0,15	0,20	0,20	0,20	0,20	0,25	0,25	0,25	0,30	0,30
8	0,12	0,12	0,15	0,20	0,20	0,20	0,20	0,20	0,25	0,25	0,25	0,25
10	0,12	0,12	0,14	0,16	0,20	0,20	0,20	0,20	0,20	0,25	0,25	0,25
12	0,11	0,12	0,14	0,16	0,16	0,20	0,20	0,20	0,20	0,20	0,25	0,25
14	0,10	0,12	0,13	0,15	0,16	0,16	0,20	0,20	0,20	0,20	0,20	0,25
16	0,09	0,10	0,12	0,15	0,15	0,16	0,16	0,20	0,20	0,20	0,20	0,20
18		0,10	0,11	0,13	0,15	0,15	0,16	0,16	0,20	0,20	0,20	0,20
20			0,10	0,12	0,13	0,15	0,15	0,16	0,16	0,20	0,20	0,20
25				0,10	0,12	0,13	0,15	0,15	0,16	0,16	0,20	0,20
32					0,10	0,12	0,13	0,15	0,15	0,16	0,16	0,20
40						0,10	0,12	0,13	0,15	0,15	0,16	0,16
50							0,10	0,12	0,13	0,15	0,15	0,16
63								0,10	0,12	0,13	0,15	0,15
80									0,10	0,12	0,13	0,15
100										0,10	0,12	0,13
160											0,10	0,12
200												0,10

*Radial feed in mm.

The specified feed rates are average recommended values.
For special applications, adjustment is recommended.

B Material groups ISO M, ISO H, heat-resistant alloys, tungsten alloys and molybdenum alloys

Feed per tooth f_z [mm]											
a_e [mm]*	Ø 0.3 mm	Ø 0.5 mm	Ø 1 mm	Ø 2 mm	Ø 3 mm	Ø 4 mm	Ø 6 mm	Ø 8 mm	Ø 10 mm	Ø 12 mm	Ø 14 mm
0,01	0,02	0,02	0,02	0,05	0,07	0,10	0,12	0,12	0,16		
0,05	0,01	0,01	0,02	0,03	0,06	0,08	0,10	0,12	0,16		
0,1	0,01	0,01	0,02	0,03	0,04	0,06	0,08	0,12	0,16	0,16	0,16
0,2	0,01	0,01	0,01	0,02	0,03	0,05	0,06	0,12	0,14	0,16	0,16
0,5		0,01	0,01	0,02	0,02	0,04	0,06	0,10	0,12	0,12	0,12
1			0,01	0,02	0,02	0,03	0,05	0,07	0,10	0,10	0,10
2				0,02	0,02	0,02	0,04	0,06	0,09	0,10	0,10
3					0,02	0,02	0,04	0,06	0,08	0,10	0,10
5						0,02	0,03	0,06	0,08	0,10	0,10
6							0,02	0,05	0,06	0,08	0,08
8								0,04	0,06	0,07	0,08
10									0,05	0,06	0,08
12										0,06	0,07
14											0,06
16											
18											
20											
25											
32											
40											
50											
63											
80											
100											
160											
200											

B Material groups ISO M, ISO H, heat-resistant alloys, tungsten alloys and molybdenum alloys

Feed per tooth f_z [mm]												
a_e [mm]*	Ø 16 mm	Ø 18 mm	Ø 20 mm	Ø 25 mm	Ø 32 mm	Ø 40 mm	Ø 50 mm	Ø 63 mm	Ø 80 mm	Ø 100 mm	Ø 160 mm	Ø 200 mm
0,01												
0,05												
0,1	0,16											
0,2	0,16	0,16	0,20									
0,5	0,12	0,16	0,20	0,20								
1	0,10	0,12	0,16	0,20	0,20	0,24	0,24	0,24	0,32	0,32	0,40	0,40
2	0,10	0,12	0,16	0,16	0,20	0,20	0,20	0,24	0,24	0,32	0,32	0,32
3	0,10	0,11	0,14	0,16	0,16	0,20	0,20	0,20	0,24	0,24	0,32	0,32
5	0,10	0,10	0,12	0,16	0,16	0,16	0,20	0,20	0,20	0,24	0,24	0,24
6	0,10	0,10	0,12	0,16	0,16	0,16	0,16	0,20	0,20	0,20	0,24	0,24
8	0,10	0,10	0,12	0,16	0,16	0,16	0,16	0,16	0,20	0,20	0,20	0,20
10	0,10	0,10	0,11	0,13	0,16	0,16	0,16	0,16	0,16	0,20	0,20	0,20
12	0,09	0,10	0,11	0,13	0,13	0,16	0,16	0,16	0,16	0,16	0,20	0,20
14	0,08	0,10	0,10	0,12	0,13	0,13	0,16	0,16	0,16	0,16	0,16	0,20
16	0,07	0,08	0,10	0,12	0,12	0,13	0,13	0,16	0,16	0,16	0,16	0,16
18		0,08	0,09	0,10	0,12	0,12	0,13	0,13	0,16	0,16	0,16	0,16
20			0,08	0,10	0,10	0,12	0,12	0,13	0,13	0,16	0,16	0,16
25				0,08	0,10	0,10	0,12	0,12	0,13	0,13	0,16	0,16
32					0,08	0,10	0,10	0,12	0,12	0,13	0,13	0,16
40						0,08	0,10	0,10	0,12	0,12	0,13	0,13
50							0,08	0,10	0,10	0,12	0,12	0,13
63								0,08	0,10	0,10	0,12	0,12
80									0,08	0,10	0,10	0,12
100										0,08	0,10	0,10
160											0,08	0,10
200												0,08

*Radial feed in mm.

Feed matrices – f_z table

The specified feed rates are average recommended values.
For special applications, adjustment is recommended.

C Material groups ISO N and ISO O

Feed per tooth f_z [mm]											
a_e [mm]*	Ø 0.3 mm	Ø 0.5 mm	Ø 1 mm	Ø 2 mm	Ø 3 mm	Ø 4 mm	Ø 6 mm	Ø 8 mm	Ø 10 mm	Ø 12 mm	Ø 14 mm
0,01	0,04	0,04	0,07	0,13	0,20	0,26	0,33	0,33	0,44		
0,05	0,03	0,03	0,06	0,09	0,15	0,22	0,26	0,33	0,44		
0,1	0,02	0,03	0,04	0,08	0,11	0,18	0,22	0,33	0,44	0,44	0,44
0,2	0,02	0,02	0,03	0,07	0,09	0,13	0,18	0,33	0,40	0,44	0,44
0,5		0,02	0,03	0,06	0,07	0,11	0,15	0,26	0,33	0,33	0,33
1			0,02	0,06	0,07	0,09	0,13	0,20	0,26	0,26	0,26
2				0,04	0,07	0,07	0,11	0,18	0,24	0,26	0,26
3					0,04	0,06	0,10	0,17	0,23	0,26	0,26
5						0,04	0,09	0,15	0,22	0,26	0,26
6							0,07	0,13	0,18	0,22	0,22
8								0,11	0,15	0,20	0,22
10									0,13	0,18	0,22
12										0,15	0,20
14											0,18
16											
18											
20											
25											
32											
40											
50											
63											
80											
100											
160											
200											

C Material groups ISO N and ISO O

Feed per tooth f_z [mm]												
a_e [mm]*	Ø 16 mm	Ø 18 mm	Ø 20 mm	Ø 25 mm	Ø 32 mm	Ø 40 mm	Ø 50 mm	Ø 63 mm	Ø 80 mm	Ø 100 mm	Ø 160 mm	Ø 200 mm
0,01												
0,05												
0,1	0,44											
0,2	0,44	0,44	0,50									
0,5	0,33	0,44	0,50	0,50								
1	0,26	0,33	0,44	0,50	0,50	0,50	0,50	0,50	0,50	0,50	0,50	0,50
2	0,26	0,33	0,44	0,44	0,50	0,50	0,50	0,50	0,50	0,50	0,50	0,50
3	0,26	0,30	0,39	0,44	0,44	0,50	0,50	0,50	0,50	0,50	0,50	0,50
5	0,26	0,26	0,33	0,44	0,44	0,44	0,50	0,50	0,50	0,50	0,50	0,50
6	0,26	0,26	0,33	0,44	0,44	0,44	0,44	0,50	0,50	0,50	0,50	0,50
8	0,26	0,26	0,33	0,44	0,44	0,44	0,44	0,44	0,55	0,55	0,55	0,55
10	0,26	0,26	0,31	0,35	0,44	0,44	0,44	0,44	0,44	0,50	0,55	0,55
12	0,24	0,26	0,31	0,35	0,35	0,44	0,44	0,44	0,44	0,44	0,50	0,50
14	0,22	0,26	0,29	0,33	0,35	0,35	0,44	0,44	0,44	0,44	0,44	0,50
16	0,20	0,22	0,26	0,33	0,33	0,35	0,35	0,44	0,44	0,44	0,44	0,44
18		0,22	0,24	0,29	0,33	0,33	0,35	0,35	0,44	0,44	0,44	0,44
20			0,22	0,26	0,29	0,33	0,33	0,35	0,35	0,44	0,44	0,44
25				0,22	0,26	0,29	0,33	0,33	0,35	0,35	0,44	0,44
32					0,22	0,26	0,29	0,33	0,33	0,35	0,35	0,44
40						0,22	0,26	0,29	0,33	0,33	0,35	0,35
50							0,22	0,26	0,29	0,33	0,33	0,35
63								0,22	0,26	0,29	0,33	0,33
80									0,22	0,26	0,29	0,33
100										0,22	0,26	0,29
160											0,22	0,26
200												0,22

*Radial feed in mm.

The specified feed rates are average recommended values.
For special applications, adjustment is recommended.

D Protostar® Flash ISO-P, M, K, N, S, O

Feed per tooth f_z [mm]											
a_e [mm]*	Ø 3 mm	Ø 4 mm	Ø 6 mm	Ø 8 mm	Ø 10 mm	Ø 12 mm	Ø 14 mm	Ø 16 mm	Ø 18 mm	Ø 20 mm	Ø 25 mm
0,8	0,07	0,10									
1,5	0,07	0,10	0,16	0,25							
3	0,07	0,10	0,16	0,25	0,30						
5		0,10	0,16	0,25	0,30	0,35					
6			0,16	0,25	0,30	0,35	0,40	0,50	0,60		
8				0,25	0,30	0,35	0,40	0,50	0,60	0,70	0,70
10					0,30	0,35	0,40	0,50	0,60	0,70	0,70
12							0,40	0,50	0,60	0,70	0,70
14							0,40	0,50	0,60	0,70	0,70
16								0,50	0,60	0,70	0,70
18									0,60	0,70	0,70
20										0,70	0,70
25											0,70

E Protostar® Flash ISO-H

Feed per tooth f_z [mm]											
a_e [mm]*	Ø 3 mm	Ø 4 mm	Ø 6 mm	Ø 8 mm	Ø 10 mm	Ø 12 mm	Ø 14 mm	Ø 16 mm	Ø 18 mm	Ø 20 mm	Ø 25 mm
0,8	0,06	0,08									
1,5	0,06	0,08	0,13	0,20							
3	0,06	0,08	0,13	0,20	0,24						
5		0,08	0,13	0,20	0,24	0,28					
6			0,13	0,20	0,24	0,28	0,32	0,40	0,48		
8				0,20	0,24	0,28	0,32	0,40	0,48	0,56	0,56
10					0,24	0,28	0,32	0,40	0,48	0,56	0,56
12							0,32	0,40	0,48	0,56	0,56
14							0,32	0,40	0,48	0,56	0,56
16								0,40	0,48	0,56	0,56
18									0,48	0,56	0,56
20										0,56	0,56
25											0,56

F Proto-max™_{ST}

Feed per tooth f_z [mm]													
a_e [mm]*	Ø 1 mm	Ø 2 mm	Ø 3 mm	Ø 4 mm	Ø 6 mm	Ø 8 mm	Ø 10 mm	Ø 12 mm	Ø 14 mm	Ø 16 mm	Ø 18 mm	Ø 20 mm	Ø 25 mm
0,01	0,04	0,08	0,11	0,14	0,18	0,18	0,24						
0,05	0,03	0,05	0,09	0,12	0,14	0,18	0,24						
0,1	0,02	0,04	0,06	0,10	0,12	0,18	0,24	0,24	0,24	0,24			
0,2	0,02	0,04	0,05	0,07	0,10	0,18	0,22	0,24	0,24	0,24	0,24	0,3	
0,5	0,01	0,03	0,04	0,06	0,08	0,14	0,18	0,18	0,18	0,18	0,24	0,3	0,30
1	0,01	0,03	0,04	0,05	0,07	0,11	0,14	0,14	0,14	0,14	0,18	0,24	0,30
2		0,02	0,04	0,04	0,06	0,10	0,13	0,14	0,14	0,14	0,18	0,24	0,24
3			0,02	0,03	0,05	0,09	0,13	0,14	0,14	0,14	0,16	0,21	0,24
5				0,02	0,05	0,08	0,12	0,14	0,14	0,14	0,14	0,18	0,24
6					0,04	0,07	0,10	0,12	0,12	0,14	0,14	0,18	0,24
8						0,06	0,08	0,11	0,12	0,14	0,14	0,18	0,24
10							0,07	0,10	0,12	0,14	0,14	0,17	0,19
12								0,08	0,11	0,13	0,14	0,17	0,19
14									0,10	0,12	0,14	0,16	0,18
16										0,11	0,12	0,14	0,18
18											0,12	0,13	0,16
20												0,12	0,14
25													0,12

*Radial feed in mm.

Feed matrices – f_z table for brazed tools

The specified feed rates are average recommended values.
For special applications, adjustment is recommended.

G Aluminium wrought alloys

Feed per tooth f_z [mm]														
a_e/D_c	Ø 6 mm	Ø 8 mm	Ø 10 mm	Ø 12 mm	Ø 16 mm	Ø 20 mm	Ø 25 mm	Ø 32 mm	Ø 40 mm	Ø 50 mm	Ø 63 mm	Ø 80 mm	Ø 100 mm	Ø 125 mm
1/50	0,08	0,07	0,09	0,09	0,12	0,12	0,12	0,15	0,15					
1/20	0,07	0,06	0,08	0,08	0,10	0,10	0,10	0,13	0,13					
1/10	0,06	0,06	0,07	0,07	0,10	0,07	0,10	0,12	0,12	0,12	0,12	0,12	0,12	0,12
1/5	0,06	0,06	0,07	0,07	0,09	0,09	0,09	0,11	0,11	0,11	0,11	0,11	0,11	0,11
1/2	0,05	0,05	0,06	0,06	0,08	0,08	0,08	0,10	0,10	0,10	0,10	0,10	0,10	0,10
1/1	0,05	0,05	0,06	0,06	0,08	0,08	0,08	0,10	0,10	0,10	0,10	0,10	0,10	0,10

H Magnesium alloys/copper and copper alloys

Feed per tooth f_z [mm]														
a_e/D_c	Ø 6 mm	Ø 8 mm	Ø 10 mm	Ø 12 mm	Ø 16 mm	Ø 20 mm	Ø 25 mm	Ø 32 mm	Ø 40 mm	Ø 50 mm	Ø 63 mm	Ø 80 mm	Ø 100 mm	Ø 125 mm
1/50	0,04	0,04	0,06	0,06	0,09	0,09	0,09	0,11	0,11					
1/20	0,04	0,04	0,05	0,05	0,08	0,08	0,08	0,10	0,10					
1/10	0,04	0,04	0,05	0,05	0,07	0,07	0,07	0,09	0,09	0,09	0,09	0,09	0,09	0,09
1/5	0,03	0,03	0,04	0,04	0,07	0,07	0,07	0,08	0,08	0,08	0,08	0,08	0,08	0,08
1/2	0,03	0,03	0,04	0,04	0,06	0,06	0,06	0,07	0,07	0,07	0,07	0,07	0,07	0,07
1/1	0,03	0,03	0,04	0,04	0,06	0,06	0,06	0,07	0,07	0,07	0,07	0,07	0,07	0,07

I Thermoplasts, thermosetting plastics, plastic, graphite

Feed per tooth f_z [mm]														
a_e/D_c	Ø 6 mm	Ø 8 mm	Ø 10 mm	Ø 12 mm	Ø 16 mm	Ø 20 mm	Ø 25 mm	Ø 32 mm	Ø 40 mm	Ø 50 mm	Ø 63 mm	Ø 80 mm	Ø 100 mm	Ø 125 mm
1/50	0,05	0,05	0,07	0,07	0,10	0,10	0,10	0,13	0,13					
1/20	0,05	0,05	0,06	0,06	0,09	0,09	0,09	0,11	0,11					
1/10	0,04	0,04	0,06	0,06	0,08	0,08	0,08	0,10	0,10	0,10	0,10	0,10	0,10	0,10
1/5	0,04	0,04	0,05	0,05	0,08	0,08	0,08	0,09	0,09	0,09	0,09	0,09	0,09	0,09
1/2	0,03	0,03	0,05	0,05	0,07	0,07	0,07	0,08	0,08	0,08	0,08	0,08	0,08	0,08
1/1	0,03	0,03	0,05	0,05	0,07	0,07	0,07	0,08	0,08	0,08	0,08	0,08	0,08	0,08

J Non-alloyed steel, malleable cast iron, ductile cast iron and CGI

Feed per tooth f_z [mm]									
a_e [mm]*	Ø 16 mm	Ø 20 mm	Ø 25 mm	Ø 32 mm	Ø 40 mm	Ø 50 mm	Ø 63 mm	Ø 80 mm	Ø 100 mm
1,0	0,12	0,12	0,12	0,12	0,13				
2,0	0,12	0,12	0,12	0,12	0,12	0,20			
3,0	0,11	0,12	0,12	0,12	0,12	0,19	0,20		
4,0	0,10	0,11	0,12	0,12	0,12	0,18	0,19	0,20	
5,0	0,10	0,10	0,11	0,12	0,12	0,18	0,18	0,19	0,20
6,0	0,10	0,10	0,10	0,11	0,12	0,17	0,18	0,18	0,19
8,0	0,10	0,10	0,10	0,10	0,11	0,17	0,17	0,18	0,18
10,0	0,10	0,10	0,10	0,10	0,10	0,17	0,17	0,17	0,18
12,0	0,10	0,10	0,10	0,10	0,10	0,16	0,17	0,17	0,17
16,0	0,10	0,10	0,10	0,10	0,10	0,15	0,16	0,17	0,17
20,0		0,10	0,10	0,10	0,10	0,15	0,15	0,16	0,17
25,0			0,10	0,10	0,10	0,15	0,15	0,15	0,16
32,0				0,10	0,10	0,15	0,15	0,15	0,15
40,0					0,10	0,15	0,15	0,15	0,15
50,0						0,15	0,15	0,15	0,15
63,0							0,15	0,15	0,15
80,0								0,15	0,15
100,0									0,15

*Radial feed in mm.

The specified feed rates are average recommended values.
For special applications, adjustment is recommended.

K Grey cast iron

Feed per tooth f_z [mm]									
a_e [mm]*	Ø 16 mm	Ø 20 mm	Ø 25 mm	Ø 32 mm	Ø 40 mm	Ø 50 mm	Ø 63 mm	Ø 80 mm	Ø 100 mm
1,0	0,13	0,13	0,13	0,14	0,15				
2,0	0,13	0,13	0,13	0,13	0,14	0,26			
3,0	0,13	0,13	0,13	0,13	0,13	0,25	0,26		
4,0	0,12	0,13	0,13	0,13	0,13	0,24	0,25	0,26	
5,0	0,12	0,12	0,13	0,13	0,13	0,24	0,24	0,25	0,26
6,0	0,12	0,12	0,12	0,13	0,13	0,23	0,24	0,24	0,25
8,0	0,12	0,12	0,12	0,12	0,13	0,22	0,23	0,24	0,24
10,0	0,12	0,12	0,12	0,12	0,12	0,22	0,22	0,23	0,24
12,0	0,12	0,12	0,12	0,12	0,12	0,21	0,22	0,22	0,23
16,0	0,12	0,12	0,12	0,12	0,12	0,20	0,21	0,22	0,22
20,0		0,12	0,12	0,12	0,12	0,20	0,20	0,21	0,22
25,0			0,12	0,12	0,12	0,20	0,20	0,20	0,21
32,0				0,12	0,12	0,20	0,20	0,20	0,20
40,0					0,12	0,20	0,20	0,20	0,20
50,0						0,20	0,20	0,20	0,20
63,0							0,20	0,20	0,20
80,0								0,20	0,20
100,0									0,20

L Low-alloyed steel, high-alloyed steel and high-alloyed tool steel

Feed per tooth f_z [mm]									
a_e [mm]*	Ø 16 mm	Ø 20 mm	Ø 25 mm	Ø 32 mm	Ø 40 mm	Ø 50 mm	Ø 63 mm	Ø 80 mm	Ø 100 mm
1,0	0,09	0,09	0,09	0,1	0,10				
2,0	0,09	0,09	0,09	0,09	0,10	0,17			
3,0	0,09	0,09	0,09	0,09	0,09	0,16	0,17		
4,0	0,08	0,09	0,09	0,09	0,09	0,15	0,16	0,17	
5,0	0,08	0,08	0,09	0,09	0,09	0,14	0,15	0,16	0,17
6,0	0,08	0,08	0,08	0,09	0,09	0,14	0,14	0,15	0,16
8,0	0,08	0,08	0,08	0,08	0,09	0,14	0,14	0,14	0,15
10,0	0,08	0,08	0,08	0,08	0,08	0,13	0,14	0,14	0,14
12,0	0,08	0,08	0,08	0,08	0,08	0,13	0,13	0,14	0,14
16,0	0,08	0,08	0,08	0,08	0,08	0,13	0,13	0,13	0,14
20,0		0,08	0,08	0,08	0,08	0,13	0,13	0,13	0,13
25,0			0,08	0,08	0,08	0,12	0,13	0,13	0,13
32,0				0,08	0,08	0,12	0,12	0,13	0,13
40,0					0,08	0,12	0,12	0,12	0,13
50,0						0,12	0,12	0,12	0,12
63,0							0,12	0,12	0,12
80,0								0,12	0,12
100,0									0,12

M Stainless steel (ISO P)

Feed per tooth f_z [mm]									
a_e [mm]*	Ø 16 mm	Ø 20 mm	Ø 25 mm	Ø 32 mm	Ø 40 mm	Ø 50 mm	Ø 63 mm	Ø 80 mm	Ø 100 mm
1,0	0,07	0,07	0,07	0,08	0,08				
2,0	0,07	0,07	0,07	0,07	0,08	0,14			
3,0	0,07	0,07	0,07	0,07	0,07	0,13	0,14		
4,0	0,06	0,07	0,07	0,07	0,07	0,12	0,13	0,14	
5,0	0,06	0,06	0,07	0,07	0,07	0,12	0,12	0,13	0,14
6,0	0,06	0,06	0,06	0,07	0,07	0,12	0,12	0,12	0,13
8,0	0,06	0,06	0,06	0,06	0,07	0,12	0,12	0,12	0,12
10,0	0,06	0,06	0,06	0,06	0,06	0,11	0,12	0,12	0,12
12,0	0,06	0,06	0,06	0,06	0,06	0,11	0,11	0,12	0,12
16,0	0,06	0,06	0,06	0,06	0,06	0,11	0,11	0,11	0,12
20,0		0,06	0,06	0,06	0,06	0,11	0,11	0,11	0,11
25,0			0,06	0,06	0,06	0,10	0,11	0,11	0,11
32,0				0,06	0,06	0,10	0,10	0,11	0,11
40,0					0,06	0,10	0,10	0,10	0,11
50,0						0,10	0,10	0,10	0,10
63,0							0,10	0,10	0,10
80,0								0,10	0,10
100,0									0,10

*Radial feed in mm.

v_c correction factors*

v_c correction factors – toolholder/steel

v_c correction factors		Type	Max. speed
AK610.Z16.E10.005	$v_c \times 1$	A	40.000
AK610.Z12.E10.005	$v_c \times 1$	A	40.000
AK610.Z10.E10.020	$v_c \times 0,9$	A	30.000
AK610.Z16.E10.050	$v_c \times 0,6$	B	12.000
AK610.Z16.E10.036	$v_c \times 0,7$	C	15.000
AK610.Z16.E12.005	$v_c \times 1$	A	40.000
AK610.Z12.E12.022	$v_c \times 0,9$	A	30.000
AK610.Z16.E12.060	$v_c \times 0,6$	B	10.000
AK610.Z16.E12.025	$v_c \times 0,7$	C	15.000
AK610.Z20.E16.005	$v_c \times 1$	A	40.000
AK610.Z16.E16.025	$v_c \times 0,9$	A	30.000
AK610.Z20.E16.025	$v_c \times 0,9$	A	30.000
AK610.Z20.E16.075	$v_c \times 0,6$	B	10.000
AK610.Z25.E16.054	$v_c \times 0,7$	C	15.000
AK610.Z20.E20.030	$v_c \times 0,8$	A	20.000
AK610.Z25.E20.005	$v_c \times 1$	A	30.000
AK610.Z32.E20.073	$v_c \times 0,7$	C	20.000
AK610.Z32.E25.005	$v_c \times 1$	A	30.000
AK610.Z25.E25.040	$v_c \times 0,7$	A	15.000
AK610.Z32.E25.045	$v_c \times 0,7$	C	20.000

Type A

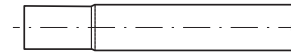

Type B

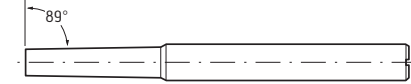

Type C

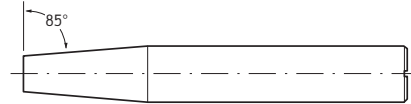

v_c correction factors – toolholder/solid carbide

v_c correction factors		Type	Max. speed
AK610.Z10.E10.050C	$v_c \times 0,8$	A	20.000
AK610.Z16.E10.100C	$v_c \times 0,7$	B	15.000
AK610.Z12.E12.048C	$v_c \times 0,9$	A	30.000
AK610.Z16.E12.090C	$v_c \times 0,7$	B	15.000
AK610.Z16.E16.080C	$v_c \times 0,9$	A	30.000
AK610.Z20.E20.110C	$v_c \times 0,9$	A	30.000
AK610.Z20.E16.118C	$v_c \times 0,6$	B	10.000
AK610.Z20.E20.038C	$v_c \times 1$	A	30.000
AK610.Z25.E25.120C	$v_c \times 0,6$	A	10.000

*** Please note:**

With ConeFit™ points, cutting speed should be adjusted based on projection length and shank type. Observe the maximum rotational speed. For cutting data, see page E-82 onwards.

Cutting tool materials and coatings

HSS cutting tool materials

For Walter Prototyp milling cutters, four groups of high-speed steel are used.

HSS	High-speed steel for general applications (side and face milling cutters)
HSS-E	High-speed steel with 5% Co for increased loading, particularly extreme thermal loading
HSS-E Co8	High-speed steel with 8% Co for maximum thermal loading capability, in accordance with American standard designation M 42 (end mills for general use, available in standard dimensions and with Morse taper shank, shell end mills)
HSS-PM	High-speed steel manufactured using powder metallurgy with extremely high alloy content Advantages: High degree of purity and uniformity of the microstructure, high wear resistance and heat resistance (end mills and shell end mills for more demanding applications)

Cutting tool materials and coatings

Material no.	Short name	Old standard Designation	AISI ASTM	AFNOR	B.S.	UNI	Alloy table					
							C	Cr	W	Mo	V	Co
1.3343	S 6-5-2	DMo5	M2	–	BM2	HS 6-5-2	0,82	4,0	6,5	5,0	2,0	–
1.3243	S 6-5-2-5	EMo5 Co5	M35	6.5.2.5	–	HS 6-5-2-5	0,82	4,5	6,0	5,0	2,0	5,0
1.3247	S 2-10-1-8	–	M42	–	BM42	HS 2-9-1-8	1,08	4,0	1,5	9,5	1,2	8,25

Trade designation ASP









Coatings

Surface coating has developed into a proven technological process for improving the performance of metal cutting tools. By contrast with surface treatment, the tool surface remains chemically unaltered and a thin layer is applied. For Walter Prototyp high-speed steel and carbide tools, the coating is produced by the PVD method, which works at process temperatures of below 600 °C and does not, therefore, result in any change to the base material. Hard material layers have a higher hardness and wear resistance than the cutting tool material itself.

Also:

- they help to improve the low-friction quality of the tool surface
- they separate the cutting tool material and the material that is going to be cut from each other
- they act as a thermal insulating layer

Coated tools not only have a longer life, they can also be used with higher cutting speeds and feed rates.

Surface treatment/ coating	Method / coating	Property	Colour	
uncoated	No treatment	–	Uncoated	
TAX	TiAlN coating	Universal coating for solid carbide milling cutters	Black-violet	
TAZ	TiAlN / zirconium nitride coating	High-performance layer specially developed for machining steel: chemical resistance to emulsions and oils; effective against built up edges	Champagne	
CRN	Chromium nitride coating	Very thin layer with high degree of toughness; minimised coating roughness for excellent chip flow, especially with aluminium materials	Rainbow-coloured	
DIA	Diamond coating	For machining graphite and AISi alloys	Grey	
ACN	Aluminium chromium nitride coating	High-performance coating with particularly low friction for titanium machining tools but also for HSS tools	Blue-violet	
TAS	TiAl-/silicon nitride coating	High-performance coating for hard machining up to 70 HRC	Bronze	
TAA	TiAlN + TiAl coating	Layer specially developed for machining stainless materials	Silver-grey	
TAT	TiAlN coating	Universal high-performance coating	Dark violet	



CONTENTS

Milling cutters with indexable inserts











	Page
Indexable inserts for milling	Product range overview F-3
	Walter Select – Milling F-4
	Walter indexable inserts for milling F-6
Walter milling cutters with indexable inserts	Product range overview F-44
	Walter Select – Face milling F-46
	Walter face milling cutters F-52
	Walter Select – Shoulder milling F-64
	Walter shoulder milling cutters F-68
	Walter Select – Slot milling F-80
	Walter slot milling cutters F-84
	Walter Select – Copy milling F-86
	Walter copy milling cutters F-88
	Technical Information
Feed determination F-110	
Cutting tool material application tables F-116	
Geometry overview for milling indexable inserts F-118	
Setting and assembly instructions F-120	
Information on high-speed cutting F-122	
Application information on milling F-124	

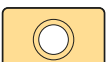
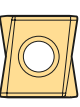







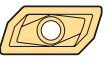



Walter BLAXX

Milling insert product range overview



Insert shape	Description	Page
 A	Positive rhombic for Xtra-tec®	F-6
 C	Tangential rhombic	F-36
 L	Positive rhombic	F-10
	Tangential rhombic	F-37
	Tangential rhombic for Xtra-tec®	F-38
 M	Tangential rhombic for Walter BLAXX	F-40
	Negative rhombic for Xtra-tec®	F-29
 M	Positive rhombic	F-11
 O	Positive octagonal for Xtra-tec®	F-13
	Finishing inserts	F-27
 R	Positive round	F-17
 S	Positive square	F-20
	Tangential square F 2254	F-42
	Negative square for Xtra-tec®	F-30
 T	Positive triangular	F-24
	Negative triangular	F-32
 X	Negative heptagon for Xtra-tec®	F-33
 X	Positive form inserts for copy milling cutters	F-25
 Z	Positive rhombic	F-26

Insert shape	Description	Page
 SX . .	Indexable inserts for Walter BLAXX slitting cutters	F-43
 P 20200	Positive rhombic	F-41
 P 23 . .	Wendelnovex® inserts	F-29
 P 236 . .	Negative triangular for Xtra-tec® high performance milling cutters	F-30
 P 263 . .	Positive triangular for high performance milling cutters	F-14
	for copy milling cutters	F-14
 P 32 . .	Indexable inserts for profile milling cutter	F-15
 P 44 . .	Tangential rhombic	F-41
 P 8001	Toric indexable inserts for Xtra-tec® profile milling cutters	F-16
	Finishing inserts	F-28
	Finishing inserts	F-34
	Finishing inserts	F-43

Walter Select for indexable inserts for milling

Step by step to the right indexable insert

STEP 1

Determine the **material** to be machined from page H 8 in the Walter General catalogue 2012.

Note the machining group that corresponds to your material e.g.: P10.

Code letter	Machining group	Groups of the materials to be machined	
P	P1–P15	Steel	All types of steel and cast steel, with the exception of steel with an austenitic structure
M	M1–M3	Stainless steel	Stainless austenitic steel, austenitic-ferritic steel and cast steel
K	K1–K7	Cast iron	Grey cast iron, cast iron with spheroidal graphite, malleable cast iron, cast iron with vermicular graphite
N	N1–N10	NF metals	Aluminium and other non-ferrous metals, non-ferrous materials
S	S1–S10	High temperature alloys and titanium alloys	Heat resisting special alloys based on iron, nickel and cobalt, titanium and titanium alloys
H	H1–H4	Hard materials	Hardened steel, hardened cast iron materials, chilled cast iron
O	O1–O6	Other	Plastics, glass and carbon fibre reinforced plastics, graphite

STEP 2

Select the **machining conditions**:

Tool projection	Machine stability, clamping system and workpiece		
	very good	good	moderate
Short projection length			
Extended tool projection			

STEP 3

Select your **tool** according to your application and individual requirements. Then select your milling cutter from the corresponding tool page.

Machining method

 Face milling See page F-46	 Circular interpolation milling See General catalogue page F 242	 Profile milling See General catalogue page F 234
 Shoulder milling See page F-64	 Slot milling See page F-80	 Copy milling See page F-86

STEP 4

Determine your optimum **indexable insert grade and geometry** on the appropriate tool page. In so doing, please take into consideration the machining conditions (step 2) and the material to be machined. For detailed geometry description for the Walter BLAXX and Xtra-tec® tools, see page F-118.

Indexable inserts

Designation	Tolerance class	Number of cutting edges	l ₂ mm	l mm	s mm	α	α ₂	r mm	b mm	P		M		K		N		S		H
										HC	WSP45	HC	WSP45	WAK15	WKP255	WKP355	WSP45	WSP45	WSP45	WSP45
ADGT0803PER-D51	G	2	6,75	9,52	3,35	15°	20°	0,4	1,2	⊗	⊗	⊗	⊗	⊗	⊗	⊗	⊗	⊗	⊗	⊗
ADGT1204PER-D51	G	2	8,4	13,6	4,76	15°	20°	0,8	1,2	⊗	⊗	⊗	⊗	⊗	⊗	⊗	⊗	⊗	⊗	⊗
ADGT1606PER-D51	G	2	10,8	17,5	6,15	15°	20°	0,8	1,6	⊗	⊗	⊗	⊗	⊗	⊗	⊗	⊗	⊗	⊗	⊗
ADGT1807PER-D51	G	2	14,5	19	7	15°	17°	1,2	1,8	⊗	⊗	⊗	⊗	⊗	⊗	⊗	⊗	⊗	⊗	⊗
ADGT0803PER-D56	G	2	6,75	9,52	3,95	15°	20°	0,4	1,2	⊗	⊗	⊗	⊗	⊗	⊗	⊗	⊗	⊗	⊗	⊗
ADGT1204PER-D56	G	2	8,4	13,6	4,76	15°	20°	0,8	1,2	⊗	⊗	⊗	⊗	⊗	⊗	⊗	⊗	⊗	⊗	⊗
ADGT1606PER-D56	G	2	10,8	17,5	6,15	15°	20°	0,8	1,6	⊗	⊗	⊗	⊗	⊗	⊗	⊗	⊗	⊗	⊗	⊗
ADGT1807PER-D56	G	2	14,5	19	7	15°	17°	1,2	1,8	⊗	⊗	⊗	⊗	⊗	⊗	⊗	⊗	⊗	⊗	⊗
ADGT10T3PER-D67	G	2	7,25	11,3	3,8	15°	15°	0,8	1,2	⊗	⊗	⊗	⊗	⊗	⊗	⊗	⊗	⊗	⊗	⊗
ADGT10T316R-D67	G	2	7,25	11,3	3,8	15°	15°	1,6	1,2	⊗	⊗	⊗	⊗	⊗	⊗	⊗	⊗	⊗	⊗	⊗
ADGT10T325R-D67	G	2	7,25	11,3	3,8	15°	15°	2,5	1	⊗	⊗	⊗	⊗	⊗	⊗	⊗	⊗	⊗	⊗	⊗
ADGT10T330R-D67	G	2	7,25	11,3	3,8	15°	15°	3	0,8	⊗	⊗	⊗	⊗	⊗	⊗	⊗	⊗	⊗	⊗	⊗
ADGT10T332R-D67	G	2	7,25	11,3	3,8	15°	15°	3,2	0,8	⊗	⊗	⊗	⊗	⊗	⊗	⊗	⊗	⊗	⊗	⊗
ADGT1204PER-D67	G	2	8,4	13,6	4,76	15°	20°	0,8	1,2	⊗	⊗	⊗	⊗	⊗	⊗	⊗	⊗	⊗	⊗	⊗
ADGT120416R-D67	G	2	8,4	13,6	4,76	15°	20°	1,6	1	⊗	⊗	⊗	⊗	⊗	⊗	⊗	⊗	⊗	⊗	⊗
ADGT120430R-D67	G	2	8,4	13,6	4,76	15°	20°	3	0,8	⊗	⊗	⊗	⊗	⊗	⊗	⊗	⊗	⊗	⊗	⊗
1606PER-D67	G	2	10,8	17,5	6,15	15°	20°	0,8	1,6	⊗	⊗	⊗	⊗	⊗	⊗	⊗	⊗	⊗	⊗	⊗
160616R-D67	G	2	10,8	17,5	6,15	15°	20°	1,6	1	⊗	⊗	⊗	⊗	⊗	⊗	⊗	⊗	⊗	⊗	⊗
160630R-D67	G	2	10,8	17,5	6,15	15°	20°	3	0,8	⊗	⊗	⊗	⊗	⊗	⊗	⊗	⊗	⊗	⊗	⊗
1803PER-F56	G	2	6,75	9,52	3,35	15°	20°	0,4	1,2	⊗	⊗	⊗	⊗	⊗	⊗	⊗	⊗	⊗	⊗	⊗
204PER-F56	G	2	8,4	13,6	4,76	15°	20°	0,8	1,2	⊗	⊗	⊗	⊗	⊗	⊗	⊗	⊗	⊗	⊗	⊗
1606PER-F56	G	2	10,8	17,5	6,15	15°	20°	0,8	1,6	⊗	⊗	⊗	⊗	⊗	⊗	⊗	⊗	⊗	⊗	⊗

WALTER SELECT

Best insert for:

good	moderate	unfavourable

machining conditions

STEP 5

Select the **cutting data** from page F-92.

Cutting data for roughing
Copy milling

☞ = Cutting data for wet machining
☞ = Dry machining is possible

Material group	Structure of main material groups and code letters	Bore hardness HB	Tensile strength R _m N/mm ²	Machining group	Cutting material grades			
					Starting values for cutting speed v _c (m/min)			
					HC WKP355			
		a _p / D _c		1/1	1/5	1/10		
P Non-alloyed steel	C ≤ 0.25 % annealed	125	428	P1	•	•	•	240 300 300
	C > 0.25... ≤ 0.55 % annealed	190	639	P2	•	•	•	200 255 275
	C > 0.25... ≤ 0.55 % tempered	210	708	P3	•	•	•	185 240 240
	C > 0.55 % annealed	190	639	P4	•	•	•	155 195 210
	C > 0.55 % tempered	300	1013	P5	•	•	•	145 180 185
	Free cutting steel (short-chipping) annealed	220	745	P6	•	•	•	200 255 275
P Low-alloyed steel	annealed	175	591	P7	•	•	•	165 210 230
	tempered	300	1013	P8	•	•	•	155 195 215
	tempered	380	1262	P9	•	•	•	145 180 200
High-alloyed steel and high-alloyed tool steel	tempered	430	1477	P10	•	•	•	120 155 170
	annealed	200	675	P11	•	•	•	110 145 160
	hardened and tempered	300	1013	P12	•	•	•	75 100 100
Stainless steel	hardened and tempered	400	1361	P13	•	•	•	65 80 90
	ferritic/martensitic, annealed	200	675	P14	•	•	•	120 155 170
M Stainless steel	martensitic, tempered	330	1114	P15	•	•	•	110 145 155
	austenitic, quench hardened	200	675	M1	•	•	•	
	austenitic, precipitation hardened (PH)	300	1013	M2	•	•	•	
	austenitic/ferritic, duplex	230	778	M3	•	•	•	
K Malleable cast iron	ferritic	200	675	K1	•	•	•	250 290 310
	pearlitic	260	867	K2	•	•	•	200 240 260
Grey cast iron		180	602		•	•	•	300

Positive rhombic

Tiger-tec®

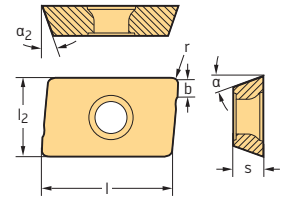

Indexable inserts

Designation	Tolerance class	Number of cutting edges	l ₂ mm	l mm	s mm	α	α ₂	r mm	b mm	P			M			K			N		S			H	
										HC	HC	HC	HC	HC	HC	HC	HC	HW	HC	HC	HC	HC			
										WKP25S	WKP35S	WSP45	WSM35	WSM35S	WSP45	WAK15	WKK25	WKP25S	WKP35S	WXN15	WK10	WSM35	WSM35S	WSP45	WHH15
ADGT0803PER-D51	G	2	6,75	9,52	3,35	15°	20°	0,4	1,2	☺	☺	☺			☺			☺	☺					☺	
ADGT1204PER-D51	G	2	8,4	13,6	4,76	15°	20°	0,8	1,2	☺	☺	☺			☺			☺	☺					☺	
ADGT1606PER-D51	G	2	10,8	17,5	6,15	15°	20°	0,8	1,6	☺	☺	☺			☺			☺	☺					☺	
ADGT1807PER-D51	G	2	14,5	19	7	15°	17°	1,2	1,8	☺	☺	☺			☺			☺	☺					☺	
ADGT0803PER-D56	G	2	6,75	9,52	3,95	15°	20°	0,4	1,2	☺	☺	☺	☺		☺			☺	☺					☺	
ADGT1204PER-D56	G	2	8,4	13,6	4,76	15°	20°	0,8	1,2	☺	☺	☺	☺		☺			☺	☺					☺	
ADGT1606PER-D56	G	2	10,8	17,5	6,15	15°	20°	0,8	1,6	☺	☺	☺	☺		☺			☺	☺					☺	
ADGT1807PER-D56	G	2	14,5	19	7	15°	17°	1,2	1,8	☺	☺	☺	☺		☺			☺	☺					☺	
ADGT10T3PER-D67	G	2	7,25	11,3	3,8	15°	15°	0,8	1,2		☺	☺	☺	☺	☺									☺	☺
ADGT10T316R-D67	G	2	7,25	11,3	3,8	15°	15°	1,6	1,2		☺	☺	☺	☺	☺									☺	☺
ADGT10T325R-D67	G	2	7,25	11,3	3,8	15°	15°	2,5	1		☺	☺	☺	☺	☺									☺	☺
ADGT10T330R-D67	G	2	7,25	11,3	3,8	15°	15°	3	0,8		☺	☺	☺	☺	☺									☺	☺
ADGT10T332R-D67	G	2	7,25	11,3	3,8	15°	15°	3,2	0,8		☺	☺	☺	☺	☺									☺	☺
ADGT1204PER-D67	G	2	8,4	13,6	4,76	15°	20°	0,8	1,2		☺	☺	☺	☺	☺									☺	☺
ADGT120416R-D67	G	2	8,4	13,6	4,76	15°	20°	1,6	1		☺	☺	☺	☺	☺									☺	☺
ADGT120430R-D67	G	2	8,4	13,6	4,76	15°	20°	3	0,8		☺	☺	☺	☺	☺									☺	☺
ADGT1606PER-D67	G	2	10,8	17,5	6,15	15°	20°	0,8	1,6		☺	☺	☺	☺	☺									☺	☺
ADGT160616R-D67	G	2	10,8	17,5	6,15	15°	20°	1,6	1		☺	☺	☺	☺	☺									☺	☺
ADGT160630R-D67	G	2	10,8	17,5	6,15	15°	20°	3	0,8		☺	☺	☺	☺	☺									☺	☺
ADGT0803PER-F56	G	2	6,75	9,52	3,35	15°	20°	0,4	1,2				☺	☺	☺									☺	☺
ADGT1204PER-F56	G	2	8,4	13,6	4,76	15°	20°	0,8	1,2				☺	☺	☺									☺	☺
ADGT1606PER-F56	G	2	10,8	17,5	6,15	15°	20°	0,8	1,6				☺	☺	☺									☺	☺
ADGT10T3PER-G77	G	2	7,25	11,3	3,8	15°	15°	0,8	1,2				☺	☺	☺									☺	☺
ADGT1204PER-G77	G	2	8,4	13,6	4,76	15°	20°	0,8	1,2				☺	☺	☺									☺	☺
ADGT1606PER-G77	G	2	10,8	17,5	6,15	15°	20°	0,8	1,6				☺	☺	☺									☺	☺

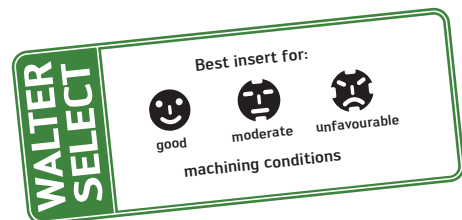
 HC = Coated carbide
 HW = Uncoated carbide



New addition to range

Positive rhombic

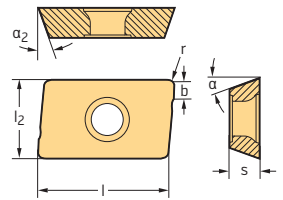
Tiger-tec®



Indexable inserts

Designation	Tolerance class	Number of cutting edges	l ₂ mm	l mm	s mm	α	α ₂	r mm	b mm	P			M			K			N		S			H
										HC			HC			HC			HC	HW	HC			HC
										WKP25S	WKP35S	WSP45	WSM35	WSM35S	WSP45	WAK15	WKK25	WKP25S	WKP35S	WXN15	WK10	WSM35	WSM35S	WSP45
 ADHT0803PEL-G88	H	2	6,75	9,52	3,35	15°	20°	0,4	1,2										☺					
ADHT0803PER-G88	H	2	6,75	9,52	3,35	15°	20°	0,4	1,2										☺	☺				
ADHT10T3PER-G88	H	2	7,25	11,3	3,8	15°	15°	0,8	1,2										☺	☺				
ADHT1204PER-G88	H	2	8,4	13,6	4,76	15°	20°	0,8	1,2										☺	☺				
ADHT1204PEL-G88	H	2	8,4	13,6	4,76	15°	20°	0,8	1,2										☺	☺				
ADHT120416R-G88	H	2	8,4	13,6	4,76	15°	20°	1,6	1										☺	☺				
ADHT120416L-G88	H	2	8,4	13,6	4,76	15°	20°	1,6	1										☺					
ADHT120425L-G88	H	2	8,4	13,6	4,76	15°	20°	2,5	0,8										☺					
ADHT120425R-G88	H	2	8,4	13,6	4,76	15°	20°	2,5	0,8										☺	☺				
ADHT120430L-G88	H	2	8,4	13,6	4,76	15°	20°	3	0,8										☺					
ADHT120430R-G88	H	2	8,4	13,6	4,76	15°	20°	3	0,8										☺	☺				
ADHT120440L-G88	H	2	8,4	13,6	4,76	15°	20°	4	0,4										☺					
ADHT120440R-G88	H	2	8,4	13,6	4,76	15°	20°	4	0,4										☺	☺				
ADHT1606PEL-G88	H	2	10,8	17,5	6,15	15°	20°	0,8	1,6										☺					
ADHT1606PER-G88	H	2	10,8	17,5	6,15	15°	20°	0,8	1,6										☺	☺				
ADHT160616L-G88	H	2	10,8	17,5	6,15	15°	20°	1,6	1,4										☺					
ADHT160616R-G88	H	2	10,8	17,5	6,15	15°	20°	1,6	1,4										☺	☺				
ADHT160625L-G88	H	2	10,8	17,5	6,15	15°	20°	2,5	1,2										☺					
ADHT160625R-G88	H	2	10,8	17,5	6,15	15°	20°	2,5	1,2										☺	☺				
ADHT160630L-G88	H	2	10,8	17,5	6,15	15°	20°	3	1,2										☺					
ADHT160630R-G88	H	2	10,8	17,5	6,15	15°	20°	3	1,2										☺	☺				
ADHT160640L-G88	H	2	10,8	17,5	6,15	15°	20°	4	1										☺					
ADHT160640R-G88	H	2	10,8	17,5	6,15	15°	20°	4	1										☺	☺				
 ADKT0803PEL-F56	K	2	6,75	9,52	3,35	15°	20°	0,4	1,2	☺	☺	☺											☺	
ADKT0803PER-F56	K	2	6,75	9,52	3,35	15°	20°	0,4	1,2	☺	☺	☺											☺	
ADKT10T3PER-F56	K	2	7,25	11,3	3,8	15°	15°	0,8	1,2	☺	☺	☺	☺	☺								☺	☺	
ADKT1204PEL-F56	K	2	8,4	13,6	4,76	15°	20°	0,8	1,2	☺	☺	☺											☺	
ADKT1204PER-F56	K	2	8,4	13,6	4,76	15°	20°	0,8	1,2	☺	☺	☺											☺	
ADKT1606PEL-F56	K	2	10,8	17,5	6,15	15°	20°	0,8	1,6	☺	☺	☺											☺	
ADKT1606PER-F56	K	2	10,8	17,5	6,15	15°	20°	0,8	1,6	☺	☺	☺											☺	
 ADMT080304R-D56	M	2	6,75	9,52	3,35	15°	20°	0,4	1,2	☺	☺	☺											☺	
ADMT120408R-D56	M	2	8,4	13,6	4,76	15°	20°	0,8	1,2	☺	☺	☺											☺	
ADMT160608R-D56	M	2	10,8	17,5	6,15	15°	20°	0,8	1,6	☺	☺	☺											☺	
ADMT180712R-D56	M	2	14,5	19	7	15°	17°	1,2	1,8	☺	☺	☺											☺	

HC = Coated carbide
HW = Uncoated carbide

Positive rhombic

Tiger-tec®

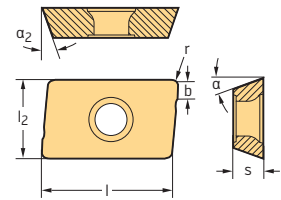

Indexable inserts

Designation	Tolerance class	Number of cutting edges	l ₂ mm	l mm	s mm	α	α ₂	r mm	b mm	P			M			K			N		S			H
										HC			HC			HC			HC	HW	HC			HC
										WKP25S	WKP35S	WSP45	WSM35	WSM35S	WSP45	WAK15	WKK25	WKP25S	WKP35S	WXN15	WK10	WSM35	WSM35S	WSP45
ADMT080302R-F56	M	2	6,75	9,52	3,35	15°	20°	0,2	1,2	⊕	⊕	⊕	⊕	⊕	⊕	⊕	⊕	⊕	⊕	⊕	⊕	⊕	⊕	⊕
ADMT080304L-F56	M	2	6,75	9,52	3,35	15°	20°	0,4	1,2	⊕	⊕	⊕	⊕	⊕	⊕	⊕	⊕	⊕	⊕	⊕	⊕	⊕	⊕	⊕
ADMT080304R-F56	M	2	6,75	9,52	3,35	15°	20°	0,4	1,2	⊕	⊕	⊕	⊕	⊕	⊕	⊕	⊕	⊕	⊕	⊕	⊕	⊕	⊕	⊕
ADMT080308L-F56	M	2	6,75	9,52	3,35	15°	20°	0,8	1,2	⊕	⊕	⊕	⊕	⊕	⊕	⊕	⊕	⊕	⊕	⊕	⊕	⊕	⊕	⊕
ADMT080308R-F56	M	2	6,75	9,52	3,35	15°	20°	0,8	1,2	⊕	⊕	⊕	⊕	⊕	⊕	⊕	⊕	⊕	⊕	⊕	⊕	⊕	⊕	⊕
ADMT080312R-F56	M	2	6,75	9,52	3,35	15°	20°	1,2	1	⊕	⊕	⊕	⊕	⊕	⊕	⊕	⊕	⊕	⊕	⊕	⊕	⊕	⊕	⊕
ADMT080316R-F56	M	2	6,75	9,52	3,35	15°	20°	1,6	1	⊕	⊕	⊕	⊕	⊕	⊕	⊕	⊕	⊕	⊕	⊕	⊕	⊕	⊕	⊕
ADMT080320R-F56	M	2	6,75	9,52	3,35	15°	20°	2	1	⊕	⊕	⊕	⊕	⊕	⊕	⊕	⊕	⊕	⊕	⊕	⊕	⊕	⊕	⊕
ADMT10T304R-F56	M	2	7,25	11,3	3,8	15°	15°	0,4	1,2	⊕	⊕	⊕	⊕	⊕	⊕	⊕	⊕	⊕	⊕	⊕	⊕	⊕	⊕	⊕
ADMT10T308R-F56	M	2	7,25	11,3	3,8	15°	15°	0,8	1,2	⊕	⊕	⊕	⊕	⊕	⊕	⊕	⊕	⊕	⊕	⊕	⊕	⊕	⊕	⊕
ADMT10T312R-F56	M	2	7,25	11,3	3,8	15°	15°	1,2	1,2	⊕	⊕	⊕	⊕	⊕	⊕	⊕	⊕	⊕	⊕	⊕	⊕	⊕	⊕	⊕
ADMT10T316R-F56	M	2	7,25	11,3	3,8	15°	15°	1,6	1,2	⊕	⊕	⊕	⊕	⊕	⊕	⊕	⊕	⊕	⊕	⊕	⊕	⊕	⊕	⊕
ADMT10T320R-F56	M	2	7,25	11,3	3,8	15°	15°	2	1	⊕	⊕	⊕	⊕	⊕	⊕	⊕	⊕	⊕	⊕	⊕	⊕	⊕	⊕	⊕
ADMT10T325R-F56	M	2	7,25	11,3	3,8	15°	15°	2,5	1	⊕	⊕	⊕	⊕	⊕	⊕	⊕	⊕	⊕	⊕	⊕	⊕	⊕	⊕	⊕
ADMT10T330R-F56	M	2	7,25	11,3	3,8	15°	15°	3	0,8	⊕	⊕	⊕	⊕	⊕	⊕	⊕	⊕	⊕	⊕	⊕	⊕	⊕	⊕	⊕
ADMT10T332R-F56	M	2	7,25	11,3	3,8	15°	15°	3,2	0,8	⊕	⊕	⊕	⊕	⊕	⊕	⊕	⊕	⊕	⊕	⊕	⊕	⊕	⊕	⊕
ADMT120404R-F56	M	2	8,4	12	3,35	15°	20°	0,4	1,2	⊕	⊕	⊕	⊕	⊕	⊕	⊕	⊕	⊕	⊕	⊕	⊕	⊕	⊕	⊕
ADMT120408L-F56	M	2	8,4	13,6	4,76	15°	20°	0,8	1,2	⊕	⊕	⊕	⊕	⊕	⊕	⊕	⊕	⊕	⊕	⊕	⊕	⊕	⊕	⊕
ADMT120408R-F56	M	2	8,4	13,6	4,76	15°	20°	0,8	1,2	⊕	⊕	⊕	⊕	⊕	⊕	⊕	⊕	⊕	⊕	⊕	⊕	⊕	⊕	⊕
ADMT120412R-F56	M	2	8,4	13,6	4,76	15°	20°	1,2	1,2	⊕	⊕	⊕	⊕	⊕	⊕	⊕	⊕	⊕	⊕	⊕	⊕	⊕	⊕	⊕
ADMT120416L-F56	M	2	8,4	13,6	4,76	15°	20°	1,6	1	⊕	⊕	⊕	⊕	⊕	⊕	⊕	⊕	⊕	⊕	⊕	⊕	⊕	⊕	⊕
ADMT120416R-F56	M	2	8,4	13,6	4,76	15°	20°	1,6	1	⊕	⊕	⊕	⊕	⊕	⊕	⊕	⊕	⊕	⊕	⊕	⊕	⊕	⊕	⊕
ADMT120420R-F56	M	2	8,4	13,6	4,76	15°	20°	2	1	⊕	⊕	⊕	⊕	⊕	⊕	⊕	⊕	⊕	⊕	⊕	⊕	⊕	⊕	⊕
ADMT120425L-F56	M	2	8,4	13,6	4,76	15°	20°	2,5	0,8	⊕	⊕	⊕	⊕	⊕	⊕	⊕	⊕	⊕	⊕	⊕	⊕	⊕	⊕	⊕
ADMT120425R-F56	M	2	8,4	13,6	4,76	15°	20°	2,5	0,8	⊕	⊕	⊕	⊕	⊕	⊕	⊕	⊕	⊕	⊕	⊕	⊕	⊕	⊕	⊕
ADMT120430L-F56	M	2	8,4	13,6	4,76	15°	20°	3	0,8	⊕	⊕	⊕	⊕	⊕	⊕	⊕	⊕	⊕	⊕	⊕	⊕	⊕	⊕	⊕
ADMT120430R-F56	M	2	8,4	13,6	4,76	15°	20°	3	0,8	⊕	⊕	⊕	⊕	⊕	⊕	⊕	⊕	⊕	⊕	⊕	⊕	⊕	⊕	⊕
ADMT120432R-F56	M	2	8,4	13,6	4,76	15°	20°	3,2	0,8	⊕	⊕	⊕	⊕	⊕	⊕	⊕	⊕	⊕	⊕	⊕	⊕	⊕	⊕	⊕
ADMT120440L-F56	M	2	8,4	13,6	4,76	15°	20°	4	0,4	⊕	⊕	⊕	⊕	⊕	⊕	⊕	⊕	⊕	⊕	⊕	⊕	⊕	⊕	⊕
ADMT120440R-F56	M	2	8,4	13,6	4,76	15°	20°	4	0,4	⊕	⊕	⊕	⊕	⊕	⊕	⊕	⊕	⊕	⊕	⊕	⊕	⊕	⊕	⊕

HC = Coated carbide
HW = Uncoated carbide

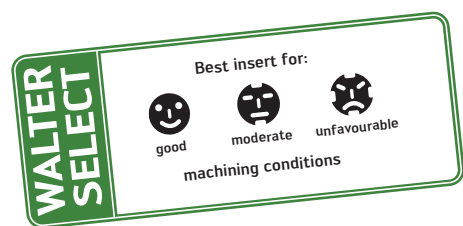



⊕ ⊕ ⊕ New addition to range

Positive rhombic

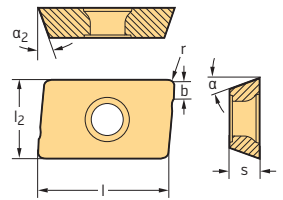
Tiger-tec®



Indexable inserts

Designation	Tolerance class	Number of cutting edges	l ₂ mm	l mm	s mm	α	α ₂	r mm	b mm	P			M			K			N		S			H
										HC			HC			HC			HC	HW	HC			HC
										WKP255	WKP355	WSP45	WSM35	WSM35S	WSP45	WAK15	WKK25	WKP255	WKP355	WXN15	WK10	WSM35	WSM35S	WSP45
 ADMT160608L-F56	M	2	10,8	17,5	6,15	15°	20°	0,8	1,6	☒	☒	☒												
ADMT160608R-F56	M	2	10,8	17,5	6,15	15°	20°	0,8	1,6	☒	☒	☒	☒	☒	☒	☒	☒							
ADMT160612R-F56	M	2	10,8	17,5	6,15	15°	20°	1,2	1,6	☒	☒	☒	☒	☒	☒	☒	☒							
ADMT160616R-F56	M	2	10,8	17,5	6,15	15°	20°	1,6	1,4	☒	☒	☒	☒	☒	☒	☒	☒							
ADMT160616L-F56	M	2	10,8	17,5	6,15	15°	20°	1,6	1,4	☒	☒	☒												
ADMT160620R-F56	M	2	10,8	17,5	6,15	15°	20°	2	1,4	☒	☒	☒	☒	☒	☒	☒	☒							
ADMT160625L-F56	M	2	10,8	17,5	6,15	15°	20°	2,5	1,2	☒	☒	☒												
ADMT160625R-F56	M	2	10,8	17,5	6,15	15°	20°	2,5	1,2	☒	☒	☒	☒	☒	☒	☒	☒							
ADMT160630L-F56	M	2	10,8	17,5	6,15	15°	20°	3	1,2	☒	☒	☒												
ADMT160630R-F56	M	2	10,8	17,5	6,15	15°	20°	3	1,2	☒	☒	☒	☒	☒	☒	☒	☒							
ADMT160632R-F56	M	2	10,8	17,5	6,15	15°	20°	3,2	1,2	☒	☒	☒	☒	☒	☒	☒	☒							
ADMT160640L-F56	M	2	10,8	17,5	6,15	15°	20°	4	1	☒	☒	☒												
ADMT160640R-F56	M	2	10,8	17,5	6,15	15°	20°	4	1	☒	☒	☒	☒	☒	☒	☒	☒							
ADMT160650R-F56	M	2	10,8	17,5	6,15	15°	20°	5		☒	☒	☒	☒	☒	☒	☒	☒							
ADMT160660R-F56	M	2	10,8	17,5	6,15	15°	20°	6		☒	☒	☒	☒	☒	☒	☒	☒							
ADMT180712R-F56	M	2	14,5	19	7	15°	17°	1,2	1,8	☒	☒	☒												
 ADMT080304R-G56	M	2	6,75	9,52	3,35	15°	20°	0,4	1,2	☒	☒	☒	☒	☒	☒	☒	☒							
ADMT10T308R-G56	M	2	7,25	11,3	3,8	15°	15°	0,8	1,2	☒	☒	☒	☒	☒	☒	☒	☒							
ADMT10T316R-G56	M	2	7,25	11,3	3,8	15°	15°	1,6	1,2	☒	☒	☒	☒	☒	☒	☒	☒							
ADMT10T325R-G56	M	2	7,25	11,3	3,8	15°	15°	2,5	1	☒	☒	☒	☒	☒	☒	☒	☒							
ADMT10T332R-G56	M	2	7,25	11,3	3,8	15°	15°	3,2	0,8	☒	☒	☒	☒	☒	☒	☒	☒							
ADMT120408R-G56	M	2	8,4	13,6	4,76	15°	20°	0,8	1,2	☒	☒	☒	☒	☒	☒	☒	☒							
ADMT160608R-G56	M	2	10,8	17,5	6,15	15°	20°	0,8	1,6	☒	☒	☒	☒	☒	☒	☒	☒							

HC = Coated carbide
HW = Uncoated carbide

Positive rhombic

Tiger-tec®

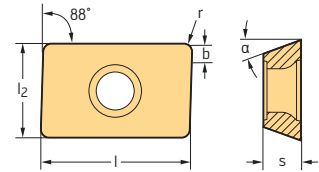

Indexable inserts

Designation	Tolerance class	Number of cutting edges	l ₂ mm	l mm	s mm	α	r mm	b mm	P			M		K			N		S		H
									HC			HC		HC			HC	HW	HC		HC
									WKP255	WKP355	WSP45	WSM35	WSP45	WAK15	WKK25	WKP255	WKP355	WXN15	WK10	WSM35	WSP45
LPGT070304R-F55	G	2	6,35	7,94	3,18	11°	0,4	1,2	☒	☒	☒	☒	☒	☒	☒	☒			☒	☒	
LPGT15T308R-F55	G	2	9,52	15	3,97	11°	0,8	1,4	☒	☒	☒	☒	☒	☒	☒	☒			☒	☒	
LPGT150412R-F55	G	2	12,7	15,88	4,76	11°	1,2	1,6	☒	☒	☒	☒	☒	☒	☒	☒			☒	☒	
LPGT1506PPR-F57	G	2	12,7	15,88	6,35	11°	1,2	1,6	☒	☒	☒	☒	☒	☒	☒	☒			☒	☒	
LPGW070304R-A57	G	2	6,35	7,94	3,18	11°	0,4	1,2	☒	☒			☒	☒	☒	☒					
LPGW15T308R-A57	G	2	9,52	15	3,97	11°	0,8	1,4	☒	☒			☒	☒	☒	☒					
LPGW150412R-A57	G	2	12,7	15,88	4,76	11°	1,2	1,6	☒	☒			☒	☒	☒	☒					
LPHW150612R-A51	H	2	15,88	12,7	6,35	11°	1,2			☒				☒							
LPMT070304R-D51	M	2	6,35	7,94	3,18	11°	0,4	1,2	☒	☒	☒	☒	☒		☒	☒			☒	☒	
LPMT15T308R-D51	M	2	9,52	15	3,97	11°	0,8	1,4	☒	☒	☒	☒	☒		☒	☒			☒	☒	
LPMT150412R-D51	M	2	12,7	15,88	4,76	11°	1,2	1,6	☒	☒	☒	☒	☒		☒	☒			☒	☒	
LPMT150612R-D51	M	2	12,7	15,88	6,35	11°	1,2			☒	☒	☒	☒		☒	☒			☒	☒	
LPMT150612R-D57	M	2	12,7	15,88	6,35	11°	1,2			☒	☒	☒	☒	☒	☒	☒			☒	☒	
LPMW070304TR-A27	M	2	6,35	7,94	3,18	11°	0,4			☒	☒			☒	☒	☒					
LPMW15T308TR-A27	M	2	9,52	15	3,97	11°	0,8			☒	☒			☒	☒	☒					
LPMW150412TR-A27	M	2	12,7	15,88	4,76	11°	1,2			☒	☒			☒	☒	☒					







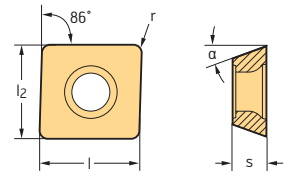

 HC = Coated carbide
 HW = Uncoated carbide

Positive rhombic

Tiger-tec®



Indexable inserts

Designation	Tolerance class	Number of cutting edges	l ₂ mm	l mm	s mm	α	r mm	P			M		K			N		S		H
								HC			HC		HC			HC	HW	HC		HC
								WKP255	WKP355	WSP45	WSM35	WSP45	WAK15	WKK25	WKP255	WKP355	WXN15	WK10	WSM35	WSP45
 MPHT120408-G88	H	2	12,7	12,7	4,76	11°	0,8									☺				
 MPHW120408-A57	H	2	12,7	12,7	4,76	11°	0,8	☺	☺				☺		☺	☺				
 MPHX060304-A57	H	2	6,35	6,35	3,18	11°	0,4	☺	☺				☺		☺	☺				
 MPHX080305-A57	H	2	8,3	8,3	3,18	11°	0,5	☺	☺				☺		☺	☺				
 MPHX060304-G88	H	2	6,35	6,35	3,18	11°	0,4								☺					
 MPHX080305-G88	H	2	8,3	8,3	3,18	11°	0,5								☺					
 MPMT120408-F57	M	2	12,7	12,7	4,76	11°	0,8		☺	☺	☺	☺			☺			☺	☺	
 MPMX060304-F57	M	2	6,35	6,35	3,18	11°	0,4		☺	☺	☺	☺			☺			☺	☺	
 MPMX080305-F57	M	2	8,3	8,3	3,18	11°	0,5		☺	☺	☺	☺	☺		☺			☺	☺	

HC = Coated carbide
HW = Uncoated carbide

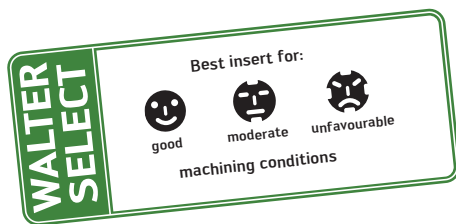

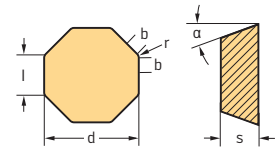

Positive octagonal

Tiger-tec®



Indexable inserts

Designation	Tolerance class	Number of cutting edges	l mm	d mm	s mm	a	r mm	b mm	P			M		K				N		S		H
									WKP25S	WKP35S	WSP45	WSP45	WSP45	WAK15	WKK25	WKP25S	WKP35S	WSP45	WCB80	WCB80	WCX15	WK10
 OPHN050412-A57 OPHN0504ZZN-A57	H	8	5	12,7	4,76	11°	1,2															
	H	8	5	12,7	4,76	11°	0,4	1,2	☹					☹	☹	☹						
 OPHN0504ZZN-A27	H	2	5	12,7	4,76	11°	0,4	1,2														

HC = Coated carbide
 CN = Silicon nitride Si₃N₄
 BH = CBN with high CBN content
 HW = Uncoated carbide

WALTER SELECT

Best insert for:

 good



 moderate

 unfavourable

machining conditions

Positive octagonal

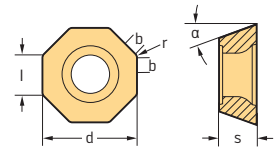
Tiger-tec®



Indexable inserts

Designation	Tolerance class	Number of cutting edges	l mm	d mm	s mm	α	r mm	b mm	P			M			K			N			S			H
									WKP25S	WKP35S	WSP45	WSM35	WSM35S	WSP45	WAK15	WKK25	WKP25S	WKP35S	WSN10	WXN15	WK10	WSM35	WSM35S	WSP45
ODHT050408-F57	H	8	5	12,7	4,76	15°	0,8		☒	☒	☒													
ODHT060512-F57	H	8	6	15,88	5,56	15°	1,2		☒	☒	☒													
ODHT050408-G88	H	8	5	12,7	4,76	15°	0,8											☒						
ODHT060512-G88	H	8	6	15,88	5,56	15°	0,8											☒						
ODHW050408-A57	H	8	5	12,7	4,76	15°	0,8																	
ODHW060512-A57	H	8	6	15,88	5,56	15°	1,2																	
ODHW050412-A57	H	8	5	12,7	4,76	15°	1,2												☒					
ODHW060516-A57	H	8	5	15,88	5,56	15°	1,6												☒					
ODHT0504ZZN-F57	H	8	5	12,7	4,76	15°	0,8	1,2	☒	☒	☒	☒	☒								☒	☒	☒	
ODHT0605ZZN-F57	H	8	6	15,88	5,56	15°	0,8	1,6	☒	☒	☒	☒	☒								☒	☒	☒	
ODHT0504ZZN-G88	H	8	5	12,7	4,76	15°	0,8	1,2											☒	☒				
ODHT0605ZZN-G88	H	8	6	15,88	5,56	15°	0,8	1,6											☒	☒				
ODHW0504ZZN-A57	H	8	5	12,7	4,76	15°	0,8	1,2	☒	☒				☒		☒	☒							
ODHW0605ZZN-A57	H	8	6	15,88	5,56	15°	0,8	1,6	☒	☒				☒		☒	☒							
ODMT050408-D57	M	8	5	12,7	4,76	15°	0,8			☒	☒	☒	☒								☒	☒		
ODMT060512-D57	M	8	6	15,88	5,56	15°	1,2			☒	☒	☒	☒								☒	☒		
ODMW050408T-A27	M	8	5	12,7	4,76	15°	0,8			☒	☒													
ODMW060508T-A27	M	8	6	15,88	5,56	15°	0,8			☒	☒													
ODMW050408-A57	M	8	5	12,7	4,76	15°	0,8			☒	☒													
ODMW060508-A57	M	8	6	15,88	5,56	15°	0,8			☒	☒													
ODMT0504ZZN-D57	M	8	5	12,7	4,76	15°	0,8	1,2	☒	☒	☒	☒	☒	☒							☒	☒	☒	
ODMT0605ZZN-D57	M	8	6	15,88	5,56	15°	0,8	1,6	☒	☒	☒	☒	☒	☒							☒	☒	☒	

*ZZN for k = 43° only

HC = Coated carbide
 CN = Silicon nitride Si₃N₄
 HW = Uncoated carbide

☒ ☒ ☒ New addition to range

Positive triangular

Tiger-tec®

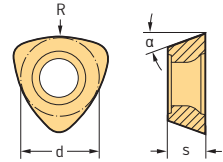

Indexable inserts

Designation	Tolerance class	Number of cutting edges	d mm	s mm	α	R mm	P			M		K			N		S		H
							HC			HC		HC			HC	HW	HC		HC
							WKP255	WKP355	WSP45	WSM35	WSP45	WAK15	WKK25	WKP255	WKP355	WXN15	WK10	WSM35	WSP45
	P26315R10	M	3	6,75	2,78	14°	10	⊕	⊕	⊕	⊕	⊕	⊕	⊕	⊕	⊕	⊕	⊕	
	P26315R12	M	3	8,5	3,18	14°	12,5	⊕	⊕	⊕	⊕	⊕	⊕	⊕	⊕	⊕	⊕	⊕	
	P26315R15	M	3	10,5	3,97	14°	15	⊕	⊕	⊕	⊕	⊕	⊕	⊕	⊕	⊕	⊕	⊕	
	P26315R16	M	3	10,5	3,97	14°	16	⊕	⊕	⊕	⊕	⊕	⊕	⊕	⊕	⊕	⊕	⊕	
	P26315R20	M	3	12,7	4,76	11°	20	⊕	⊕	⊕	⊕	⊕	⊕	⊕	⊕	⊕	⊕	⊕	
	P26315R25	M	3	12,7	4,76	11°	25	⊕	⊕	⊕	⊕	⊕	⊕	⊕	⊕	⊕	⊕	⊕	
	P26315R31	M	3	12,7	4,76	11°	31,5	⊕	⊕	⊕	⊕	⊕	⊕	⊕	⊕	⊕	⊕	⊕	
	P26325R25	M	3	13	5,56	14°	25	⊕	⊕	⊕	⊕	⊕	⊕	⊕	⊕	⊕	⊕	⊕	
	P26325R31	M	3	13	5,56	14°	31,5	⊕	⊕	⊕	⊕	⊕	⊕	⊕	⊕	⊕	⊕	⊕	

 HC = Coated carbide
 HW = Uncoated carbide

Positive triangular

Tiger-tec®

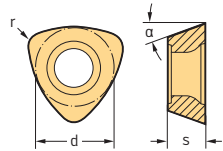

Indexable inserts

Designation	Tolerance class	Number of cutting edges	d mm	s mm	α	r mm	P			M		K			N		S		H
							HC			HC		HC			HC	HW	HC		HC
							WKP255	WKP355	WSP45	WSM35	WSP45	WAK15	WKK25	WKP255	WKP355	WXN15	WK10	WSM35	WSP45
	P26335R10	M	3	6,75	3,18	14°	0,8	⊕	⊕	⊕	⊕	⊕	⊕	⊕	⊕	⊕	⊕	⊕	
	P26335R14	M	3	9,52	3,97	14°	1,2	⊕	⊕	⊕	⊕	⊕	⊕	⊕	⊕	⊕	⊕	⊕	
	P26335R25	M	3	13	5,56	14°	2	⊕	⊕	⊕	⊕	⊕	⊕	⊕	⊕	⊕	⊕	⊕	
	P26337R10	M	3	6,75	3,18	14°	0,8	⊕	⊕	⊕	⊕	⊕	⊕	⊕	⊕	⊕	⊕	⊕	
	P26337R14	M	3	9,52	3,97	14°	1,2	⊕	⊕	⊕	⊕	⊕	⊕	⊕	⊕	⊕	⊕	⊕	
	P26337R25	M	3	13	5,56	14°	2	⊕	⊕	⊕	⊕	⊕	⊕	⊕	⊕	⊕	⊕	⊕	
	P26339R10	M	3	6,75	3,18	14°	0,8	⊕	⊕	⊕	⊕	⊕	⊕	⊕	⊕	⊕	⊕	⊕	
	P26339R14	M	3	9,52	3,97	14°	1,2	⊕	⊕	⊕	⊕	⊕	⊕	⊕	⊕	⊕	⊕	⊕	
	P26339R25	M	3	13	5,56	14°	2	⊕	⊕	⊕	⊕	⊕	⊕	⊕	⊕	⊕	⊕	⊕	

 HC = Coated carbide
 HW = Uncoated carbide

Positive triangular

Tiger-tec®

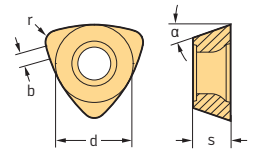

Indexable inserts

Designation	Tolerance class	Number of cutting edges	d mm	s mm	α	r mm	b mm	P			M		K		N		S		H
								HC			HC		HC		HC	HW	HC		HC
								WKP255	WKP355	WSP45	WSM35	WSP45	WAK15	WKK25	WKP255	WKP355	WXN15	WK10	WSM35
 P26379-R10	M	3	6,75	3,18	14°	0,8	0,9	☒	☒	☒	☒	☒					☒	☒	
P26379-R14	M	3	9,52	3,97	14°	1,2	1	☒	☒	☒	☒	☒					☒	☒	
P26379-R25	M	3	13	5,6	14°	2	1,1	☒	☒	☒	☒	☒					☒	☒	



HC = Coated carbide
HW = Uncoated carbide

Indexable inserts

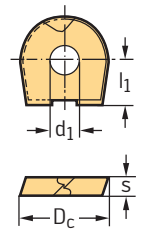
Tiger-tec®



Indexable inserts

Designation	Tolerance class	Number of cutting edges	Dc mm	s mm	l1 mm	d1 mm	P			M		K		N		S		H	
							HC			HC		HC		HC	HW	HC		HC	
							WKP25	WKP35	WSP46	WSM36	WSP46	WAK15	WKK25	WKP25	WKP35	WXN15	WK10	WSM36	WSP46
 P3201-D08	H	2	8	2	4	3	☒	☒				☒	☒					☒	
P3201-D10	H	2	10	2,5	5	4	☒	☒				☒	☒					☒	
P3201-D12	H	2	12	2,5	6	5	☒	☒				☒	☒					☒	
P3201-D16	H	2	16	3	6	5	☒	☒				☒	☒					☒	
P3201-D20	H	2	20	3	6	5	☒	☒				☒	☒					☒	
P3201-D25	H	2	25	4	9	6	☒	☒				☒	☒					☒	
P3201-D30	H	2	30	5	10	8	☒	☒				☒	☒					☒	
P3201-D32	H	2	32	5	10	8	☒	☒				☒	☒					☒	
 P3204-D08	H	2	8	2	4	3	☒		☒	☒							☒	☒	☒
P3204-D10	H	2	10	2,5	5	4	☒		☒	☒							☒	☒	☒
P3204-D12	H	2	12	2,5	6	5	☒		☒	☒							☒	☒	☒
P3204-D16	H	2	16	3	6	5	☒		☒	☒							☒	☒	☒
P3204-D20	H	2	20	3	6	5	☒		☒	☒							☒	☒	☒
P3204-D25	H	2	25	4	9	6	☒		☒	☒							☒	☒	☒
P3204-D30	H	2	30	5	10	8	☒		☒	☒							☒	☒	☒
P3204-D32	H	2	32	5	10	8	☒		☒	☒							☒	☒	☒

HC = Coated carbide
HW = Uncoated carbide

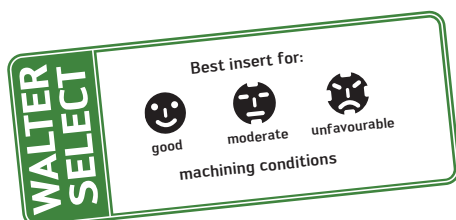

Profile mill inserts

Tiger-tec®

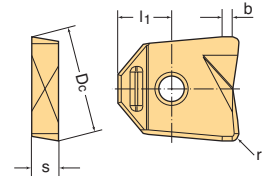

Indexable inserts

Designation	Tolerance class	Number of cutting edges	D _c mm	s mm	r mm	b mm	l ₁ mm	P			M		K			N		S		H
								HC			HC		HC			HC	HW	HC		HC
								WKP25	WKP35	WSP46	WSM36	WSP46	WAK15	WKK25	WKP25	WKP35	WXN15	WK10	WSM36	WSP46
 P8001-D12R05R-A57	H	2	12	2,5	0,5	1,5	7	☒	☒	☒	☒	☒	☒	☒	☒	☒	☒	☒	☒	☒
P8001-D12R10R-A57	H	2	12	2,5	1	1,5	7	☒	☒	☒	☒	☒	☒	☒	☒	☒	☒	☒	☒	☒
P8001-D16R10R-A57	H	2	16	4	1	1,5	8	☒	☒	☒	☒	☒	☒	☒	☒	☒	☒	☒	☒	☒
P8001-D20R16R-A57	H	2	20	5	1,6	1,5	10,2	☒	☒	☒	☒	☒	☒	☒	☒	☒	☒	☒	☒	☒
P8001-D25R20R-A57	H	2	25	6	2	1,5	10,7	☒	☒	☒	☒	☒	☒	☒	☒	☒	☒	☒	☒	☒
P8001-D32R20R-A57	H	2	32	6	2	1,5	12	☒	☒	☒	☒	☒	☒	☒	☒	☒	☒	☒	☒	☒

HC = Coated carbide
HW = Uncoated carbide

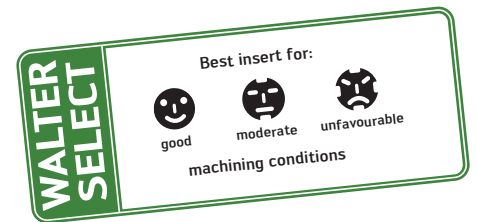

Positive round

Tiger-tec®

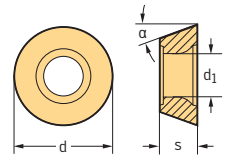

Indexable inserts

Designation	Tolerance class	Number of cutting edges	d mm	s mm	α	d1 mm	P			M			K			N		S			H	
							HC			HC			HC			HC	HW	HC			HC	
							WKP25S	WKP35S	WSP45	WSM35	WSM35S	WSP45	WAK15	WKK25	WKP25S	WKP35S	WXN15	WK10	WSM35	WSM35S	WSP45	WHH15
ROGX0803M0-G77	G	4	8	3,18	11°	3,4																
ROGX10T3M0-G77	G	4	10	3,97	11°	4,4																
ROGX1204M0-G77	G	4	12	4,76	11°	4,4																
ROGX1605M0-G77	G	6	16	5,56	15°	5,5																
ROHX0803M0T-A27	H	4	8	3,18	11°	3,4																
ROHX10T3M0T-A27	H	4	10	3,97	11°	4,4																
ROHX1204M0T-A27	H	4	12	4,76	11°	4,4																
ROHX1605M0T-A27	H	6	16	5,56	15°	5,5																
ROHX2006M0T-A27	H	8	20	6,35	15°	6,5																
ROHX0803M0-D57	H	4	8	3,18	11°	3,4																
ROHX10T3M0-D57	H	4	10	3,97	11°	4,4																
ROHX1204M0-D57	H	4	12	4,76	11°	4,4																
ROHX1605M0-D57	H	6	16	5,56	15°	5,5																
ROHX2006M0-D57	H	8	20	6,35	15°	6,5																
ROHX0803M0-D67	H	4	8	3,18	11°	3,4																
ROHX10T3M0-D67	H	4	10	3,97	11°	4,4																
ROHX1204M0-D67	H	4	11,95	4,76	11°	4,4																
ROHX1605M0-D67	H	6	16	5,56	15°	5,5																
ROMX0803M0-D57	M	4	8	3,18	11°	3,4																
ROMX10T3M0-D57	M	4	10	3,97	11°	4,4																
ROMX1204M0-D57	M	4	12	4,76	11°	4,4																
ROMX1605M0-D57	M	6	16	5,56	15°	5,5																
ROMX2006M0-D57	M	8	20	6,35	15°	6,5																
ROHX10T3M0-F67	H	4	10	3,97	11°	4,4																
ROHX1204M0-F67	H	4	12	4,76	11°	4,4																

HC = Coated carbide
HW = Uncoated carbide

Positive round

Tiger-tec®

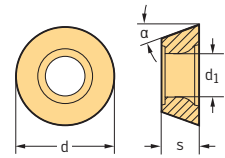

Indexable inserts

Designation	Tolerance class	d mm	s mm	α	d ₁ mm	P			M			K			N		S			H	HF	
						HC			HC			HC			HC	HW	HC			HC	HF	
						WKP25S	WKP35S	WSP45	WSM35	WSM35S	WSP45	WAK15	WKK25	WKP25S	WKP35S	WXN15	WK10	WSM35	WSM35S	WSP45	WHH15	WMG40
	RDGT0803M0-G85	G	8	3,18	15°	3,4																⊕
	RDGT10T3M0-G85	G	10	3,97	15°	4,4																⊕
	RDGT1204M0-G85	G	12	4,76	15°	4,4																⊕
	RDGT1605M0-G85	G	16	5,56	15°	5,5																⊕
	RDGT2006M0-G85	G	20	6,35	15°	6,5																⊕
	RDGT0803M0-G88	G	8	3,18	15°	3,4							⊕	⊕								
	RDGT10T3M0-G88	G	10	3,97	15°	4,4							⊕	⊕								
	RDGT1204M0-G88	G	12	4,76	15°	4,4							⊕	⊕								
	RDGT1605M0-G88	G	16	5,56	15°	5,5							⊕	⊕								
	RDGT2006M0-G88	G	20	6,35	15°	6,5							⊕	⊕								
	RDHW0803M0T-A27	H	8	3,18	15°	3,4	⊕	⊕					⊕	⊕								
	RDHW10T3M0T-A27	H	10	3,97	15°	4,4	⊕	⊕					⊕	⊕								
	RDHW1204M0T-A27	H	12	4,76	15°	4,4	⊕	⊕					⊕	⊕								
	RDHW1605M0T-A27	H	16	5,56	15°	5,5	⊕	⊕					⊕	⊕								
	RDHW2006M0T-A27	H	20	6,35	15°	6,5	⊕	⊕					⊕	⊕								
	RDHW0803M0-A57	H	8	3,18	15°	3,4							⊕									⊕
	RDHW10T3M0-A57	H	10	3,97	15°	4,4							⊕									⊕
	RDHW1204M0-A57	H	12	4,76	15°	4,4							⊕									⊕
	RDHW1605M0-A57	H	16	5,56	15°	5,5							⊕									⊕
	RDHW2006M0-A57	H	20	6,35	15°	6,5							⊕									⊕
	RDMT0803M0-D57	M	8	3,18	15°	3,4	⊕	⊕	⊕	⊕	⊕	⊕				⊕	⊕	⊕	⊕	⊕	⊕	
	RDMT10T3M0-D57	M	10	3,97	15°	4,4	⊕	⊕	⊕	⊕	⊕	⊕				⊕	⊕	⊕	⊕	⊕	⊕	
	RDMT1204M0-D57	M	12	4,76	15°	4,4	⊕	⊕	⊕	⊕	⊕	⊕				⊕	⊕	⊕	⊕	⊕	⊕	
	RDMT1605M0-D57	M	16	5,56	15°	5,5	⊕	⊕	⊕	⊕	⊕	⊕				⊕	⊕	⊕	⊕	⊕	⊕	
	RDMT2006M0-D57	M	20	6,35	15°	6,5	⊕	⊕	⊕	⊕	⊕	⊕				⊕	⊕	⊕	⊕	⊕	⊕	
	RDMW0803M0T-A27	M	8	3,18	15°	3,4	⊕	⊕					⊕	⊕								
	RDMW10T3M0T-A27	M	10	3,97	15°	4,4	⊕	⊕					⊕	⊕								
	RDMW1204M0T-A27	M	12	4,76	15°	4,4	⊕	⊕					⊕	⊕								
	RDMW1605M0T-A27	M	16	5,56	15°	5,5	⊕	⊕					⊕	⊕								
	RDMW2006M0T-A27	M	20	6,35	15°	6,5	⊕	⊕					⊕	⊕								

HC = Coated carbide

HW = Uncoated carbide

HF = Uncoated fine-grained carbide

Positive round

Tiger-tec®

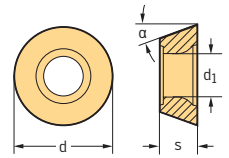

Indexable inserts

Designation	Tolerance class	d mm	s mm	α	d ₁ mm	P			M		K			N		S		H	
						HC			HC		HC			HC	HW	HC		HC	HF
						WKP255	WKP355	WSP45	WSM35	WSP45	WAK15	WKK25	WKP255	WKP355	WXN15	WK10	WSM35	WSP45	WHH15
RDHX0702M0T-A27	H	7	2,35	15°	2,8	☹	☹					☹	☹						
RDHX0711M0T-A27	H	7	1,96	15°	2,8	☹	☹					☹	☹						
RDHX1003M0T-A27	H	10	3,15	15°	4,4	☹	☹					☹	☹						
RDHX12T3M0T-A27	H	12	3,94	15°	4,4	☹	☹					☹	☹						
RDHX1604M0T-A27	H	16	4,73	15°	5,5	☹	☹					☹	☹						
RDHX2006M0T-A27	H	20	5,97	15°	5,5	☹	☹					☹	☹						
RDHX0501M0-A57	H	5	1,47	15°	2,15														☹
RDHX0702M0-A57	H	7	2,35	15°	2,8														☹
RDHX0711M0-A57	H	7	1,96	15°	2,8														☹
RDHX1003M0-A57	H	10	3,15	15°	4,4														☹
RDHX12T3M0-A57	H	12	3,94	15°	4,4														☹
RDHX1604M0-A57	H	16	4,73	15°	5,5														☹
RDGX0501M0-G85	G	5	1,45	15°	2,15														☹
RDGX0702M0-G85	G	7	2,33	15°	2,8														☹
RDGX0711M0-G85	G	7	1,94	15°	2,8														☹
RDGX1003M0-G85	G	10	3,13	15°	4,4														☹
RDGX12T3M0-G85	G	12	3,92	15°	4,4														☹
RDGX1604M0-G85	G	16	4,71	15°	5,5														☹
RDMX0702M0T-A27	M	7	2,33	15°	2,8	☹	☹					☹	☹						
RDMX1003M0T-A27	M	10	3,15	15°	4,4	☹	☹					☹	☹						
RDMX12T3M0T-A27	M	12	3,92	15°	4,4	☹	☹					☹	☹						
RDMX1604M0T-A27	M	16	4,71	15°	5,5	☹	☹					☹	☹						
RDMX2006M0T-A27	M	20	5,95	15°	5,5	☹	☹					☹	☹						

HC = Coated carbide
 HW = Uncoated carbide
 HF = Uncoated fine-grained carbide

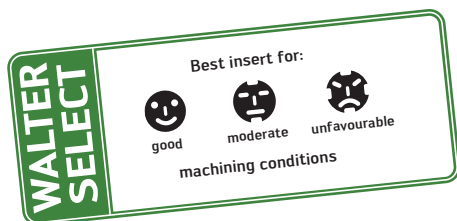

Positive square

Tiger-tec®

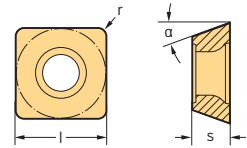

Indexable inserts

Designation	Tolerance class	Number of cutting edges	l mm	s mm	α	r mm	P			M			K			N		S			H	
							HC			HC			HC			CN	HC	HW	HC			HC
							WKP25S	WKP35S	WSP45	WSM35	WSM35S	WSP45	WAK15	WKK25	WKP25S	WKP35S	WSN10	WXN15	WK10	WSM35	WSM35S	WSP45
SPGT120606-F57	G	4	12,7	6,35	11°	0,6	☺	☺	☺	☺	☺	☺				☺		☺	☺	☺		
SDHW09T312-A57	H	4	9,52	3,97	15°	1,2										☺						
SPHT060304-G88	H	4	6,35	3,18	11°	0,4										☺	☺					
SPHT09T308-G88	H	4	9,52	3,97	11°	0,8										☺	☺					
SPHT120408-G88	H	4	12,7	4,76	11°	0,8										☺	☺					
SPHW120412-A57	H	4	12,7	4,76	11°	1,2										☺						
SPHW120416-A57	H	4	12,7	4,76	11°	1,6										☺						
SPMT060304-D51	M	4	6,35	3,18	11°	0,4	☹	☹	☹	☹	☹	☹				☹		☹	☹	☹		
SPMT09T308-D51	M	4	9,52	3,97	11°	0,8	☹	☹	☹	☹	☹	☹				☹		☹	☹	☹		
SPMT120408-D51	M	4	12,7	4,76	11°	0,8	☹	☹	☹	☹	☹	☹				☹		☹	☹	☹		
SPMT120606-D51	M	4	12,7	6,35	11°	0,6	☹	☹	☹	☹	☹	☹				☹		☹	☹	☹		
SPMT120606-D57	M	4	12,7	6,35	11°	0,6	☹	☹	☹	☹	☹	☹	☹			☹		☹	☹	☹		
SPMT060304-F55	M	4	6,35	3,18	11°	0,4	☹	☹	☹	☹	☹	☹	☹			☹		☹	☹	☹		
SPMT09T308-F55	M	4	9,52	3,97	11°	0,8	☹	☹	☹	☹	☹	☹	☹			☹		☹	☹	☹		
SPMT120408-F55	M	4	12,7	4,76	11°	0,8	☹	☹	☹	☹	☹	☹	☹			☹		☹	☹	☹		
SPMW060304T-A27	M	4	6,35	3,18	11°	0,4	☹	☹	☹				☹			☹		☹	☹	☹		
SPMW09T308T-A27	M	4	9,52	3,97	11°	0,8	☹	☹	☹				☹			☹		☹	☹	☹		
SPMW120408T-A27	M	4	12,7	4,76	11°	0,8	☹	☹	☹				☹			☹		☹	☹	☹		
SPMW060304-A57	M	4	6,35	3,18	11°	0,4	☹	☹	☹				☹			☹		☹	☹	☹		
SPMW09T308-A57	M	4	9,52	3,97	11°	0,8	☹	☹	☹				☹			☹		☹	☹	☹		
SPMW120408-A57	M	4	12,7	4,76	11°	0,8	☹	☹	☹				☹			☹		☹	☹	☹		

HC = Coated carbide
 CN = Silicon nitride Si₃N₄
 HW = Uncoated carbide

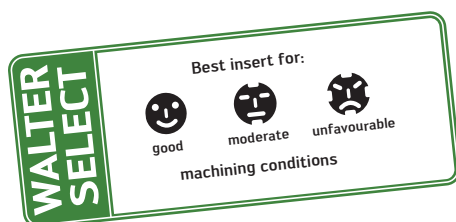



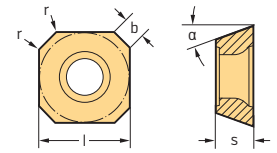









Positive square

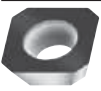

Tiger-tec®

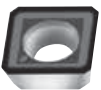
Indexable inserts

Designation	Tolerance class	Number of cutting edges	l mm	s mm	α	r mm	b mm	P			M		K			N		S		H
								HC			HC		HC			HC	HW	HC		HC
								WKP255	WKP355	WSP45	WSM35	WSP45	WAK15	WKK25	WKP255	WKP355	WXN15	WK10	WSM35	WSP45
 SDGT09T3AEN-F57	G	4	9,52	3,97	15°	0,3	1,2	⊕	⊕	⊕	⊕	⊕	⊕	⊕						
 SDGT09T3AEN-G88	G	4	9,52	3,97	15°	0,3	1,2								⊕	⊕				
 SDHW09T3AEN-A57	H	4	9,52	3,97	15°	0,3	1,2	⊕	⊕		⊕	⊕	⊕							
 SDMT09T3AEN-D57	M	4	9,52	3,97	15°	0,5	1,2	⊕	⊕	⊕	⊕			⊕				⊕	⊕	
 SDMW09T3AETN-A27	M	4	9,52	3,97	15°	0,5	1,2	⊕	⊕				⊕	⊕						
 SDMW09T3AEN-A57	M	4	9,52	3,97	15°	0,5	1,2	⊕	⊕		⊕	⊕	⊕							
 SEHT1204AFN	H	4	12,7	4,76	20°	0,8	2	⊕	⊕	⊕	⊕			⊕	⊕	⊕	⊕			
 SEHT1204AFN-K88	H	4	12,7	4,76	20°	0,8	1,8								⊕					
 SEHW1204AFN	H	4	12,7	4,76	20°	0,8	2	⊕	⊕		⊕		⊕							
 SEHW1504AFN	H	4	15,88	4,76	20°	0,8	2,1	⊕	⊕				⊕							
 SPGT1204AEN-K88	G	4	12,7	4,76	11°		1,5								⊕	⊕				
 SPKT1204AZN	K	4	12,7	4,76	11°		1,4	⊕	⊕	⊕	⊕	⊕		⊕				⊕	⊕	
 SPKT1504AZN	K	4	15,88	4,76	11°		1,7	⊕	⊕				⊕							

HC = Coated carbide
HW = Uncoated carbide



⊕ ⊕ ⊕ New addition to range

Positive square

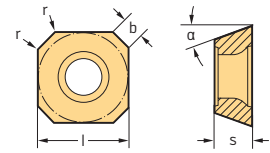
Tiger-tec®



Indexable inserts

Designation	Tolerance class	Number of cutting edges	l mm	s mm	α	r mm	b mm	P		M		K			N		S		H
								HC		HC		HC			HC	HW	HC		HC
								WKP255	WKP355	WSP45	WSM35	WSP45	WAK15	WKK25	WKP255	WKP355	WXN15	WK10	WSM35
 SPMT1204AEN	M	4	12,7	4,76	11°	0,5	1,4	☞	☞	☞	☞	☞	☞	☞	☞	☞	☞	☞	
 SPMW1204AEN-A57	M	4	12,7	4,76	11°	0,5	1,4	☞			☞	☞							
 SPMW1204AETN-A27	M	4	12,7	4,76	11°	0,5	1,4	☞				☞							



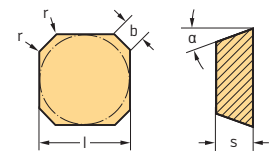

HC = Coated carbide
HW = Uncoated carbide

Positive square

Tiger-tec®



Indexable inserts

Designation	Tolerance class	Number of cutting edges	l mm	s mm	α	r mm	b mm	P		M		K			N		S		H
								HC		HC		HC			HC	HW	HC		HC
								WKP255	WKP355	WSP45	WSM35	WSP45	WAK15	WKK25	WKP255	WKP355	WXN15	WK10	WSM35
 SEKR1203AFTN	K	4	12,7	3,18	20°	0,425	1,9	☞					☞						
 SEKR1204AFN	K	4	12,7	4,76	20°	0,34	1,9	☞					☞						
 SEKN1203AFN	K	4	12,7	3,18	20°	0,625	1,9	☞			☞		☞						
 SEKN1504AFN	K	4	15,88	4,76	20°	0,35	2	☞					☞						
 SEMR1203AFTN	M	4	12,7	3,18	20°	0,5	1,9	☞					☞						

HC = Coated carbide
HW = Uncoated carbide

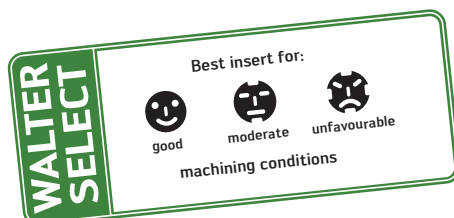

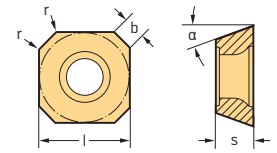

☞ ☞ ☞ New addition to range

Positive square



Tiger-tec®

Indexable inserts

Designation	Tolerance class	Number of cutting edges	l mm	s mm	α	r mm	b mm	P			M		K			N		S		H
								HC			HC		HC			HC	HW	HC		HC
								WKP25S	WKP35S	WSP45	WSM35	WSP45	WAK15	WKK25	WKP25S	WKP35S	WXN15	WK10	WSM35	WSP45
 SPGT1204EDR-F55	G	4	12,7	4,76	11°	0,5	1,25	☞	☞	☞	☞	☞	☞	☞	☞	☞	☞	☞	☞	
 SPJW1204EDR	J	4	12,7	4,76	11°		1,4	☞	☞			☞		☞						
 SPJW1504EDR	J	4	15,88	4,76	11°		1,5	☞	☞			☞		☞						





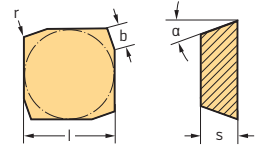



HC = Coated carbide
HW = Uncoated carbide

Positive square



Tiger-tec®

Indexable inserts



Designation	Tolerance class	Number of cutting edges	l mm	s mm	α	r mm	b mm	P			M		K			N		S		H
								HC			HC		HC			HC	HW	HC		HC
								WKP25S	WKP35S	WSP45	WSM35	WSP45	WAK15	WKK25	WKP25S	WKP35S	WXN15	WK10	WSM35	WSP45
 SPFN1204EDN	F	4	12,7	4,76	11°	0,5	1,7	☞	☞			☞		☞						
 SPFN1204ZPN	F	4	12,7	4,76	11°	0,8	1,7	☞	☞			☞		☞						
 SPFR1204EDR	F	4	12,7	4,76	11°	0,5	2	☞	☞			☞		☞						
 SPFR1204ZPN	F	4	12,7	4,76	11°	0,8	1,7	☞	☞			☞		☞						
 SPFR1204ZPR	F	4	12,7	4,76	11°	0,8	1,7	☞	☞			☞		☞						
 SPKN1203EDR	K	4	12,7	3,18	11°		1,4	☞	☞			☞		☞						
 SPKN1204EDR	K	4	12,7	4,76	11°		1,4	☞	☞			☞		☞						
 SPKN1504EDR	K	4	15,88	4,76	11°		1,5	☞	☞			☞		☞						
 SPMN1203EDR	M	4	12,7	3,18	11°		0,2	☞	☞			☞		☞						

HC = Coated carbide
HW = Uncoated carbide

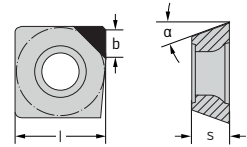
Positive square



Indexable inserts

	Designation	Tolerance class	Number of cutting edges	l mm	s mm	α	b mm	P			M		K			N			S		H	
								HC	HC	HC	HC	HC	HC	HC	HC	HC	HC	HC				
								WKP25S	WKP35S	WSP45	WSM35	WSP45	WAK15	WKK25	WKP25S	WKP35S	WXN15	WK10	WCD10	WSM35	WSP45	WHH15
	SPHW1204EDR-A88	H	1	12,7	4,76	11°	1,5													⊕		
	SPHW1204PDR-A88	H	1	12,7	4,76	11°	1,5													⊕		

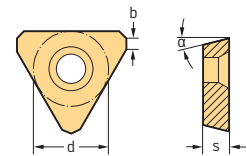

HC = Coated carbide
 HW = Uncoated carbide
 DP = Polycrystalline diamond

Positive triangular



Tiger-tec®

Indexable inserts

	Designation	Tolerance class	Number of cutting edges	d mm	s mm	α	b mm	P			M		K			N		S		H	
								HC	HC	HC	HC	HC	HC	HC	HC	HC	HC				
								WKP25S	WKP35S	WSP45	WSM35	WSP45	WAK15	WKK25	WKP25S	WKP35S	WXN15	WK10	WSM35	WSP45	WHH15
	TPAW1604PPN	A	3	9,52	4,76	11°	1,2	⊕							⊕						
	TPAW2204PPN	A	3	12,7	4,76	11°	1,2	⊕							⊕						
	TPJW1604PPN	J	3	9,52	4,76	11°	1,2	⊕					⊕		⊕						
	TPJW2204PPN	J	3	12,7	4,76	11°	1,2	⊕					⊕		⊕						

HC = Coated carbide
 HW = Uncoated carbide

Form inserts, positive

Tiger-tec®

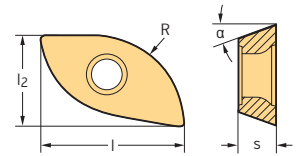

Indexable inserts

Designation	Tolerance class	Number of cutting edges	l ₂ mm	l mm	s mm	α	R mm	P				M			K			N		S			H		
								HC				HC			HC			HC	HW	HC			HC		
								WKP25S	WKP35S	WSP45	WSP45S	WSM35	WSP45	WSP45S	WAK15	WKK25	WKP25S	WKP35S	WXN15	WK10	WSM35	WSP45	WSP45S	WHH15	
	XDMT1303080R-F55	M	2	8,56	13,18	3,99	15°	8	☺	☺	☺	☺	☺	☺			☺	☺				☺	☺		
	XDMT16T3100R-F55	M	2	9	15,93	4,99	15°	10	☺	☺	☺	☺	☺				☺	☺				☺	☺		
	XDMT2004125R-F55	M	2	11,26	19,94	6,24	15°	12,5	☺	☺	☺	☺	☺				☺	☺				☺	☺		
	XDMT2405150R-F55	M	2	13,52	23,94	7,5	15°	15	☺	☺	☺	☺	☺				☺	☺				☺	☺		
	XDMT2506160R-F55	M	2	14,43	25,54	8,03	15°	16	☺	☺	☺	☺	☺				☺	☺				☺	☺		
	XDMT3207200R-F55	M	2	18,05	31,95	10	15°	20	☺	☺	☺	☺	☺				☺	☺				☺	☺		
	XDMT4009250R-F55	M	2	22,57	39,95	12,5	15°	25	☺	☺	☺	☺	☺				☺	☺				☺	☺		
	XDGT16T3100R-D57	G	2	9	15,93	3,74	15°	10		☺	☺			☺			☺								☺
	XDGT2004125R-D57	G	2	11,26	19,94	4,68	15°	12,5		☺	☺			☺			☺								☺
	XDGT2405150R-D57	G	2	13,52	23,94	5,62	15°	15		☺	☺			☺			☺								☺
	XDGT2506160R-D57	G	2	14,43	25,54	6	15°	16		☺	☺			☺			☺								☺
	XDGT3207200R-D57	G	2	18,05	31,95	7,5	15°	20		☺	☺			☺			☺								☺
	XDGT4009250R-D57	G	2	22,57	39,95	9,39	15°	25		☺	☺			☺			☺								☺

HC = Coated carbide
HW = Uncoated carbide

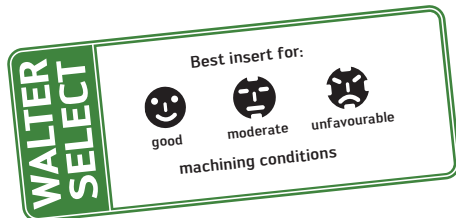

Positive rhombic

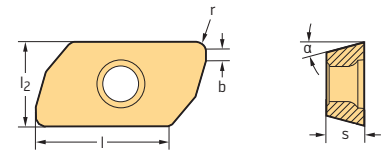

Indexable inserts

Designation	Tolerance class	Number of cutting edges	l ₂ mm	l mm	s mm	α	r mm	b mm	P			M		K			N		S		H	HF	
									HC			HC		HC			HC	HW	HC		HC		
									WKP255	WKP355	WSP45	WSM35	WSP45	WAK15	WKK25	WKP255	WKP355	WXN15	WK10	WSM35	WSP45	WHH15	WMG40
 ZDGT150404R-K85	G	2	10,5	16,2	4,76	15°	0,4	1,2															
ZDGT150408R-K85	G	2	10,5	16,2	4,76	15°	0,8	1,2															
ZDGT150412R-K85	G	2	10,5	16,2	4,76	15°	1,2	1,2															
ZDGT150416R-K85	G	2	10,5	16,2	4,76	15°	1,6	1,2															
ZDGT150420R-K85	G	2	10,5	16,2	4,76	15°	2	1,2															
ZDGT150425R-K85	G	2	10,5	16,2	4,76	15°	2,5	1,2															
ZDGT150430R-K85	G	2	10,5	16,2	4,76	15°	3	1,2															
ZDGT150440R-K85	G	2	10,5	16,2	4,76	15°	4	1,2															
ZDGT200508R-K85	G	2	14	21,2	5,56	15°	0,8	1,2															
ZDGT200512R-K85	G	2	14	21,2	5,56	15°	1,2	1,2															
ZDGT200516R-K85	G	2	14	21,2	5,56	15°	1,6	1,2															
ZDGT200520R-K85	G	2	14	21,2	5,56	15°	2	1,2															
ZDGT200530R-K85	G	2	14	21,2	5,56	15°	3	1,2															
ZDGT200540R-K85	G	2	14	21,2	5,56	15°	4	1,2															
ZDGT200550R-K85	G	2	14	21,2	5,56	15°	5	1,2															
ZDGT200560R-K85	G	2	14	21,2	5,56	15°	6	1,2															
ZDGT200564R-K85	G	2	14	21,2	5,56	15°	6,4	1,2															

HC = Coated carbide
 HW = Uncoated carbide
 HF = Uncoated fine-grained carbide

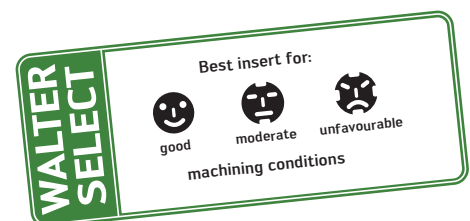

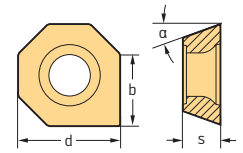

Finishing inserts

Tiger-tec®



Indexable inserts

Designation	Tolerance class	Number of cutting edges	d mm	s mm	α	b mm	P			M		K			N		S		H		
							WKP255	WKP355	WSP45	WSM35	WSP45	WAK15	WKK25	WKP255	WKP355	WC	HW	HC	HW	HC	HW
 ODHX0504ZZR-A57 ODHX0605ZZR-A57	H	1	12,7	4,76	15°	7,2	☒	☒				☒							☒	☒	
	H	1	15,88	5,56	15°	9,4	☒					☒								☒	☒
 ODHX0605ZZN-A88	H	8	15,88	5,56	15°	6						☒								☒	☒
 ODHX0605ZZN-A57	H	8	15,88	5,56	15°	6						☒								☒	☒



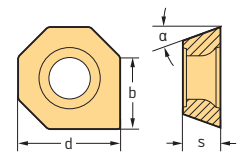

HC = Coated carbide
HW = Uncoated carbide

Finishing inserts

Tiger-tec®



Indexable inserts

Designation	Tolerance class	Number of cutting edges	d mm	s mm	α	b mm	P			M		K			N		S		H			
							WKP255	WKP355	WSP45	WSM35	WSP45	WAK15	WKK25	WKP255	WKP355	WC	HW	HC	HW	HC	HW	HC
 OPHX0504ZZN-A88	H	8	12,7	4,76	11°	5														☒	☒	
 OPHX0504ZZR-A27	H	1	12,7	4,76	11°	7,8																
 OPHX0504ZZN-A57	H	8	12,7	4,76	11°	5															☒	☒
 OPHX0504ZZR-A57	H	1	12,7	4,76	11°	7,8															☒	☒



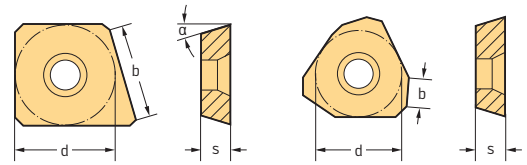

HC = Coated carbide
BH = CBN with high CBN content
HW = Uncoated carbide

Finishing inserts

Tiger-tec®



Indexable inserts

Designation	Tolerance class	Number of cutting edges	d mm	s mm	α	b mm	P			M		K			N			S		H		
							WKP25S	WKP35S	WSP45	WSM35	WSP45	WAK15	WKK25	WKP25S	WKP35S	HC	HC	HC	HW	DP	HC	HC
 P2901-1R	H	1	12,7	4,76	11°	11																
 P2903-2R	A	3	9,52	4,76	11°	3,5																
 P2905-1	F	4	12,7	4,76	11°	10																
 SPHX1204PDR-A88	H	1	12,7	4,76	11°	3,5																

HC = Coated carbide
 HW = Uncoated carbide
 DP = Polycrystalline diamond

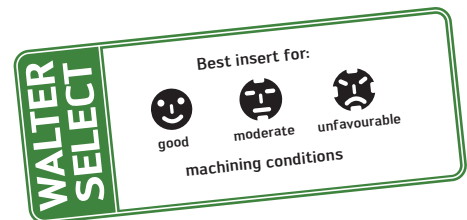

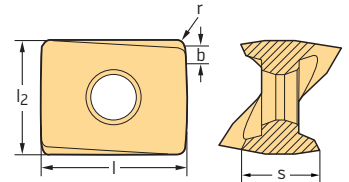

Negative rhombic

Tiger-tec®



Indexable inserts

Designation	Tolerance class	Number of cutting edges	l ₂ mm	l mm	s mm	r mm	b mm	P			M			K			N		S			H		
								HC	HC	HC	HC	HC	HC	HC	HW	HC	HC	HC	HC					
								WKP25S	WKP35S	WSP45	WSM35	WSM35S	WSP45	WAK15	WKK25	WKP25S	WKP35S	WXN15	WK10	WSM35	WSM35S	WSP45	WHH15	
 LNGX130708R-L55	G	4	11	13,6	7,74	0,8	1,2	⊕	⊕	⊕	⊕	⊕	⊕	⊕	⊕	⊕	⊕			⊕	⊕	⊕		
LNGX130712R-L55	G	4	11	13,6	7,63	1,2	1	⊕	⊕	⊕	⊕	⊕	⊕	⊕	⊕	⊕	⊕			⊕	⊕	⊕		
LNGX130716R-L55	G	4	11	13,6	7,51	1,6	0,9	⊕	⊕	⊕	⊕	⊕	⊕	⊕	⊕	⊕	⊕			⊕	⊕	⊕		
LNGX130720R-L55	G	4	11	13,6	7,41	2	0,7	⊕	⊕	⊕	⊕	⊕	⊕	⊕	⊕	⊕	⊕			⊕	⊕	⊕		
LNGX130725R-L55	G	4	11	13,6	7,27	2,5	0,6	⊕	⊕	⊕	⊕	⊕	⊕	⊕	⊕	⊕	⊕			⊕	⊕	⊕		
LNGX130730R-L55	G	4	11	13,6	7,12	3	0,7	⊕	⊕	⊕	⊕	⊕	⊕	⊕	⊕	⊕	⊕			⊕	⊕	⊕		
 LNGX130708R-L88	G	4	11	13,6	7,73	0,8	1,2											⊕	⊕					
LNGX130712R-L88	G	4	11	13,6	7,65	1,2	1											⊕	⊕					
LNGX130716R-L88	G	4	11	13,6	7,55	1,6	0,9											⊕	⊕					
LNGX130720R-L88	G	4	11	13,6	7,46	2	0,7											⊕	⊕					
LNGX130725R-L88	G	4	11	13,6	7,36	2,5	0,6											⊕	⊕					
LNGX130730R-L88	G	4	11	13,6	7,25	3	0,7											⊕	⊕					



HC = Coated carbide
HW = Uncoated carbide

Wendelnovex® inserts

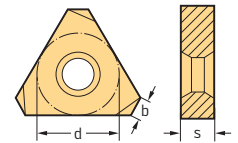
Tiger-tec®



Indexable inserts

Designation	Tolerance class	Number of cutting edges	d mm	s mm	b mm	P			M			K			N		S			H			
						HC	HC	HC	HC	HC	HC	HC	HW	HC	HC	HC	HC						
						WKP25S	WKP35S	WSP45	WSM35	WSP45	WAK15	WKK25	WKP25S	WKP35S	WXN15	WK10	WSM35	WSP45	WHH15				
 P2352-1R	A	6	15	4,5	1,1	⊕	⊕				⊕			⊕									
P2352-2R	A	6	18	4,5	1,1	⊕	⊕							⊕									
 P23522-1R	A	6	15	4,5	1,1	⊕	⊕							⊕									
 P2372-1R	A	6	15	4,5	1,1	⊕	⊕							⊕									

HC = Coated carbide
HW = Uncoated carbide

Negative triangular

Tiger-tec®

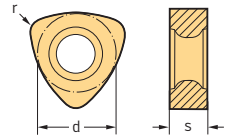

Indexable inserts

Designation	Tolerance class	Number of cutting edges	d mm	s mm	r mm	P			M			K			N		S			H
						HC			HC			HC			HC	HW	HC			HC
						WKP25S	WKP35S	WSP45	WSM35	WSM35S	WSP45	WAK15	WKK25	WKP25S	WKP35S	WXN15	WK10	WSM35	WSM35S	WSP45
P23696-1.0	M	6	9,52	5	1,2	⊕	⊕	⊗	⊗	⊗	⊗		⊕	⊗			⊕	⊕	⊗	
P23696-2.0	M	6	13,5	7	1,6	⊕	⊕	⊗	⊗	⊗	⊗		⊕	⊗			⊕	⊕	⊗	

HC = Coated carbide
HW = Uncoated carbide

Negative square

Tiger-tec®

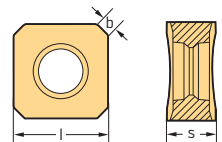

Indexable inserts

Designation	Tolerance class	Number of cutting edges	l mm	s mm	b mm	P			M			K			N		S			H
						HC			HC			HC			HC	HW	HC			HC
						WKP25S	WKP35S	WSP45	WSM35	WSM35S	WSP45	WAK15	WKK25	WKP25S	WKP35S	WXN15	WK10	WSM35	WSM35S	WSP45
SNGX1205ANN-D27	G	8	12,7	6,4	1,5	⊕	⊕	⊗					⊕	⊕	⊗					
SNGX1205ANN-F27	G	8	12,7	6,4	1,5	⊕	⊕	⊗					⊕	⊕	⊗					
SNGX1205ANN-F57	G	8	12,7	6,4	1,5	⊕	⊕	⊗	⊕	⊕	⊗			⊕	⊕	⊗				
SNGX1205ANN-F67	G	8	12,7	6,4	1,5	⊕	⊕	⊗	⊕	⊕	⊗	⊕		⊕	⊕	⊗				
SNGX1606ANN-D27	G	8	16	7,7	1,8	⊕	⊕	⊗					⊕	⊕	⊗					
SNGX1606ANN-F27	G	8	16	7,7	1,8	⊕	⊕	⊗					⊕	⊕	⊗					
SNGX1606ANN-F57	G	8	16	7,7	1,8	⊕	⊕	⊗	⊕	⊕	⊗			⊕	⊕	⊗				
SNGX1606ANN-F67	G	8	16	7,7	1,8	⊕	⊕	⊗	⊕	⊕	⊗	⊕		⊕	⊕	⊗				
SNMX1205ANN-F27	M	8	12,7	6,4	1,5	⊕	⊕	⊗					⊕	⊕	⊗					
SNMX1205ANN-F57	M	8	12,7	6,4	1,5	⊕	⊕	⊗					⊕	⊕	⊗					
SNMX1205ANN-F67	M	8	12,7	6,4	1,5	⊕	⊕	⊗			⊕		⊕	⊕	⊗					
SNHX1205ANN-K88	H	8	12,7	6,4	1,5								⊕	⊕						

HC = Coated carbide
HW = Uncoated carbide

Negative square

Tiger-tec®

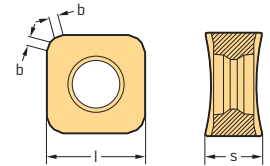

Indexable inserts

Designation	Tolerance class	Number of cutting edges	l mm	s mm	b mm	P			M			K			N		S			H	
						HC			HC			HC			HC	HW	HC			HC	
						WKP25S	WKP35S	WSP45	WSM35	WSM35S	WSP45	WAK15	WKK25	WKP25S	WKP35S	WXN15	WK10	WSM35	WSM35S	WSP45	WHH15
SNGX1205ENN-F27	G	8	12,7	6,4	1,2	☺	☺	☺													
SNGX1205ENN-F57	G	8	12,7	6,4	1,2	☺	☺	☺	☺	☺	☺	☺	☺	☺				☺	☺	☺	
SNGX1205ENN-F67	G	8	12,7	6,4	1,2	☺	☺	☺	☺	☺	☺	☺	☺				☺	☺	☺		

HC = Coated carbide
HW = Uncoated carbide

Negative square

Tiger-tec®

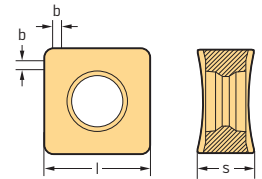

Indexable inserts

Designation	Tolerance class	Number of cutting edges	l mm	s mm	b mm	P			M			K			N		S			H	
						HC			HC			HC			HC	HW	HC			HC	
						WKP25S	WKP35S	WSP45	WSM35	WSM35S	WSP45	WAK15	WKK25	WKP25S	WKP35S	WXN15	WK10	WSM35	WSM35S	WSP45	WHH15
SNGX1205ZNN-F27	G	8	12,7	6,4	1,2	☺	☺	☺													
SNGX1205ZNN-F57	G	8	12,7	6,4	1,2	☺	☺	☺	☺	☺	☺	☺	☺	☺				☺	☺	☺	
SNGX1205ZNN-F67	G	8	12,7	6,4	1,2	☺	☺	☺	☺	☺	☺	☺	☺				☺	☺	☺		

HC = Coated carbide
HW = Uncoated carbide

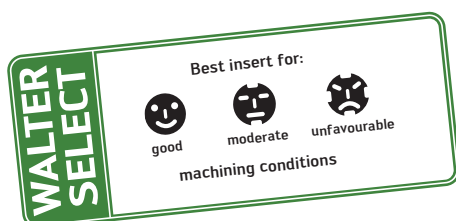

Negative square

Tiger-tec®

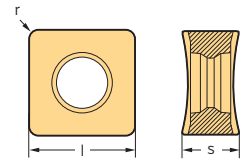

Indexable inserts

Designation	Tolerance class	Number of cutting edges	l mm	s mm	r mm	P			M			K			N		S			H
						HC			HC			HC			HC	HW	HC			HC
						WKP255	WKP355	WSP45	WSM35	WSM35S	WSP45	WAK15	WKK25	WKP255	WKP355	WXN15	WK10	WSM35	WSM35S	WSP45
SNGX120512-F57	G	8	12,7	6,4	1,2	☺	☺	☺												
SNMX120512-D27	M	8	12,7	6,4	1,2	☺	☺					☺	☺							
SNMX120512-F27	M	8	12,7	6,4	1,2	☺	☺					☺	☺							
SNMX120512-F57	M	8	12,7	6,4	1,2	☺	☺	☺				☺	☺							
SNMX120512-F67	M	8	12,7	6,4	1,2	☺	☺	☺	☺			☺	☺							
SNMX120520-D27	M	8	12,7	6,4	2	☺	☺					☺	☺							
SNMX120520-F57	M	8	12,7	6,4	2	☺	☺	☺	☺			☺	☺							
SNMX160620-D27	M	8	16	7,8	2	☺	☺					☺	☺							
SNMX160620-F27	M	8	16	7,8	2	☺	☺					☺	☺							
SNMX160620-F57	M	8	16	7,8	2	☺	☺	☺	☺			☺	☺							
SNMX160620-F67	M	8	16	7,8	2	☺	☺	☺	☺	☺		☺	☺							
SNMX160640-D27	M	8	16	7,8	4	☺	☺					☺	☺							
SNMX160640-F27	M	8	16	7,8	4	☺	☺					☺	☺							
SNMX160640-F57	M	8	16	7,8	4	☺	☺					☺	☺							

HC = Coated carbide
HW = Uncoated carbide

Negative triangular

Tiger-tec®

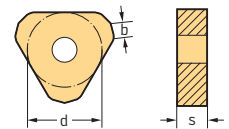

Indexable inserts

Designation	Tolerance class	Number of cutting edges	d mm	s mm	b mm	P			M			K			N		S			H
						HC			HC			HC			HC	HW	HC			HC
						WKP255	WKP355	WSP45	WSM35	WSP45	WAK15	WKK25	WKP255	WKP355	WXN15	WK10	WSM35	WSP45	WHH15	
TNEF1204AN-D57	E	6	12,7	4,76	1,8	☺	☺				☺	☺	☺	☺						

HC = Coated carbide
HW = Uncoated carbide

☺ ☺ ☺ New addition to range

Negative heptagonal

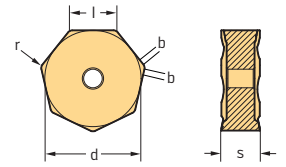

Tiger-tec®

Indexable inserts

Designation	Tolerance class	Number of cutting edges	d mm	l mm	s mm	r mm	b mm	P			M		K			N		S		H
								HC			HC		HC			HC	HW	HC		HC
								WKP255	WKP355	WSP45	WSM35	WSP45	WAK15	WKK25	WKP255	WKP355	WXN15	WK10	WSM35	WSP45
	XNHF070508-D27	H	14	14,5	7	5,8	0,8	☺	☺				☺	☺	☺					
	XNHF070508-D57	H	14	14,5	7	5,8	0,8	☺	☺				☺	☺	☺					
	XNHF070508-D67	H	14	14,5	7	5,8	0,8	☺	☺			☺	☺	☺	☺					
	XNHF090612-D27	H	14	19,05	9	6,35	1,2						☺	☺	☺					
	XNHF090612-D57	H	14	19,05	9	6,35	1,2						☺	☺	☺					
	XNHF090612-D67	H	14	19,05	9	6,35	1,2						☺	☺	☺					
	XNHF0705ANN-D27	H	14	14,5	7	5,8	0,8	1,1	☺	☺				☺	☺	☺				
	XNHF0705ANN-D57	H	14	14,5	7	5,8	0,8	1,1	☺	☺				☺	☺	☺				
	XNHF0705ANN-D67	H	14	14,5	7	5,8	0,8	1,1	☺	☺			☺	☺	☺					
	XNHF0906ANN-D27	H	14	19,05	9	6,35	0,8	1,4	☺	☺				☺	☺	☺				
	XNHF0906ANN-D57	H	14	19,05	9	6,35	0,8	1,4	☺	☺				☺	☺	☺				
	XNHF0906ANN-D67	H	14	19,05	9	6,35	0,8	1,4	☺	☺				☺	☺	☺				

HC = Coated carbide
HW = Uncoated carbide

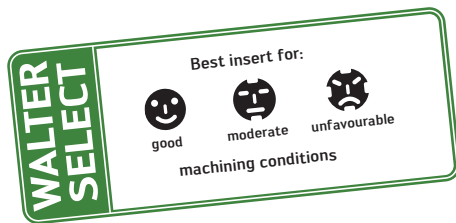

Finishing inserts

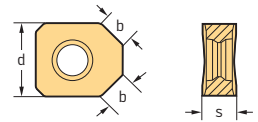

Tiger-tec®

Indexable inserts

Designation	Tolerance class	Number of cutting edges	d mm	s mm	b mm	P			M		K			N		S		H		
						WKP25S	WKP35S	WSP45	WSM35	WSP45	WAK15	WKK25	WKP25S	WKP35S	WXN15	WK10	WSM35	WSP45	WHH15	WXM15
XNGX1205ANN-F67	G	2	12,7	6,02	4,7						☺								☺	☹

HC = Coated carbide
HW = Uncoated carbide

Finishing inserts

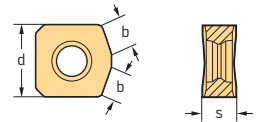

Tiger-tec®

Indexable inserts

Designation	Tolerance class	Number of cutting edges	d mm	s mm	b mm	P			M		K			N		S		H		
						WKP25S	WKP35S	WSP45	WSM35	WSP45	WAK15	WKK25	WKP25S	WKP35S	WXN15	WK10	WSM35	WSP45	WHH15	WXM15
XNGX1205ENN-F67	G	2	12,7	6,08	4,5						☺								☺	☹

HC = Coated carbide
HW = Uncoated carbide

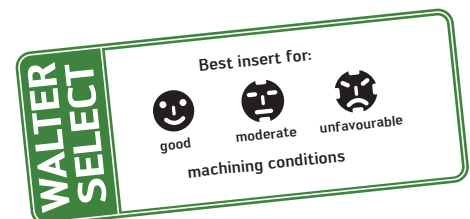

Finishing inserts

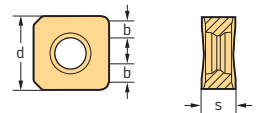

Tiger-tec®

Indexable inserts

Designation	Tolerance class	Number of cutting edges	d mm	s mm	b mm	P			M		K			N		S		H	
						WKP255	WKP355	WSP45	WSM35	WSP45	WAK15	WKK25	WKP255	WKP355	WXN15	WK10	WSM35	WSP45	WHH15
 XNGX1205ZNN-F67	G	2	12,7	6,47	4														

HC = Coated carbide
HW = Uncoated carbide

Finishing inserts

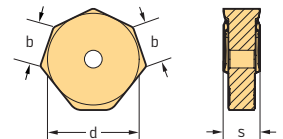

Tiger-tec®

Indexable inserts

Designation	Tolerance class	Number of cutting edges	d mm	s mm	b mm	P			M		K			N		S		H	
						WKP255	WKP355	WSP45	WSM35	WSP45	WAK15	WKK25	WKP255	WKP355	WXN15	WK10	WSM35	WSP45	WHH15
 XNHX0705ANN-D67	H	2	14,5	4,2	5,78														

HC = Coated carbide
HW = Uncoated carbide

Tangential rhombic

Tiger-tec®

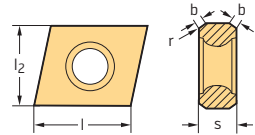

Indexable inserts

Designation	Tolerance class	Number of cutting edges	l ₂ mm	l mm	s mm	r mm	b mm	P			M		K			N		S		H
								HC			HC		HC			HC	HW	HC		HC
								WKP255	WKP355	WSP45	WSM35	WSP45	WAK15	WKK25	WKP255	WKP355	WXN15	WK10	WSM35	WSP45
	CNHQ0805PPN-A57T	H	2	9	8	5	0,8	1,2	☒	☒				☒						
	CNHQ1206PPN-A57T	H	2	13	12	6,5	0,8	1,5	☒	☒				☒						
	CNHQ1608PPN-A57T	H	2	15	16	8	1,2	1,8	☒	☒				☒						
	CNHU0805PPN-D57T	H	2	9	8	5	0,8	1,2	☒	☒	☒	☒						☒	☒	
	CNHU1206PPN-D57T	H	2	13	12	6,5	0,8	1,5	☒	☒	☒	☒						☒	☒	
	CNHU1608PPN-D57T	H	2	15	16	8	1,2	1,8	☒	☒	☒	☒						☒	☒	
	CNMQ080508T-A27T	M	2	9	8	5	0,8			☒										
	CNMQ120608T-A27T	M	2	13	12	6,5	0,8			☒										
	CNMQ160812T-A27T	M	2	15	16	8	1,2			☒										
	CNMQ080508-A57T	M	2	9	8	5	0,8			☒										
	CNMQ120608-A57T	M	2	13	12	6,5	0,8			☒										
	CNMQ160812-A57T	M	2	15	16	8	1,2			☒										
	CNMQ080508-D57T	M	2	9	8	5	0,8			☒	☒	☒						☒	☒	
	CNMQ120608-D57T	M	2	13	12	6,5	0,8			☒	☒	☒						☒	☒	
	CNMQ160812-D57T	M	2	15	16	8	1,2			☒	☒	☒						☒	☒	

 Note: l₂ = Cutting width

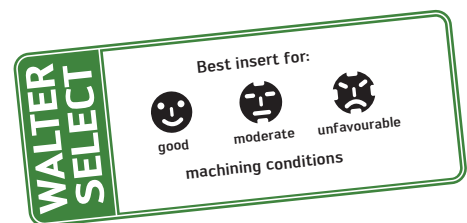

 HC = Coated carbide
 HW = Uncoated carbide

Tangential rhombic

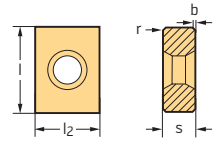
Tiger-tec®

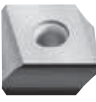

Indexable inserts

Designation	Tolerance class	Number of cutting edges	l ₂ mm	l mm	s mm	r mm	b mm	P			M			K			N		S		H	
								HC	HC	HC	HC	HC	HC	HW	HC	HC	HC					
								WKP255	WKP355	WSP45	WSM35	WSP45	WAK15	WKK25	WKP255	WKP355	WXN15	WK10	WSM35	WSP45	WHH15	
 LNKU2010DPTR-F27T LNKU3010DPTR-F27T	K	4	15	20	10,5	0,6	1,2	⊕							⊕							
	K	4	15	30	10,5	0,6	1,2	⊕							⊕							
 LNKU2010DPR-F57T LNKU3010DPR-F57T	K	4	15	20	10,5	0,6	1,2	⊕	⊗					⊕	⊗							
	K	4	15	30	10,5	0,6	1,2	⊕	⊗					⊕	⊗							



HC = Coated carbide
HW = Uncoated carbide

Tangential rhombic

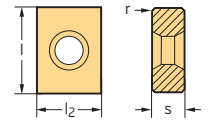
Tiger-tec®



Indexable inserts

Designation	Tolerance class	Number of cutting edges	l ₂ mm	l mm	s mm	r mm	P			M			K			N		S		H		
							HC	HC	HC	HC	HC	HC	HW	HC	HC	HC						
								WKP255	WKP355	WSP45	WSM35	WSP45	WAK15	WKK25	WKP255	WKP355	WXN15	WK10	WSM35	WSP45	WHH15	
 LNMM150812T-F27T LNMM201012T-F27T	M	4	14	15	8	1,2	⊕	⊗							⊕	⊗						
	M	4	16	20	10	1,2	⊕	⊗							⊕	⊗						
 LNMM150812-F57T LNMM201012-F57T	M	4	14	15	8	1,2	⊕	⊗					⊕	⊗	⊕	⊗						
	M	4	16	20	10	1,2	⊕	⊗					⊕	⊗	⊕	⊗						



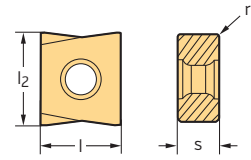

HC = Coated carbide
HW = Uncoated carbide

Tangential rhombic

Tiger-tec®



Indexable inserts

Designation	Tolerance class	Number of cutting edges	l ₂ mm	l mm	s mm	r mm	P			M		K			N		S		H
							HC		WSP45	HC		WAK15	HC		WXN15	WK10	HC		WHH15
							WKP255	WKP355		WSM35	WSP45		WKK25	WKP255			WKP355	WSM35	
 LNHU080304-B57T	H	4	9	8	3,5	0,4		⊗				⊗	⊗						
LNHU080404-B57T	H	4	9,4	8	4,5	0,4		⊗				⊗	⊗						
LNHU100508-B57T	H	4	12,3	10	5,5	0,8		⊗				⊗	⊗						
LNHU120608-B57T	H	4	13,9	12	6,5	0,8		⊗				⊗	⊗						
LNHU160812-B57T	H	4	16	17,4	8	1,2		⊗				⊗	⊗						
 LNHU080304-F57T	H	4	9	8	3,5	0,4	⊕	⊗	⊗	⊗	⊗		⊕				⊗	⊗	
LNHU080404-F57T	H	4	9,4	8	4,5	0,4	⊕	⊗	⊗	⊗	⊗		⊕				⊗	⊗	
LNHU100508-F57T	H	4	12,3	10	5,5	0,8	⊕	⊗	⊗	⊗	⊗		⊕				⊗	⊗	
LNHU120608-F57T	H	4	13,9	12	6,5	0,8	⊕	⊗	⊗	⊗	⊗		⊕				⊗	⊗	
LNHU160812-F57T	H	4	16	16,9	8	1,2	⊕	⊗	⊗	⊗	⊗		⊕				⊗	⊗	
 LNMU080304-B57T	M	4	8	9	3,5	0,4		⊗				⊗	⊗						
LNMU080404-B57T	M	4	9,4	8	4,5	0,4		⊗				⊗	⊗						
LNMU100508-B57T	M	4	12,3	10	5,5	0,8		⊗				⊗	⊗						
LNMU120608-B57T	M	4	13,9	12	6,5	0,8		⊗				⊗	⊗						
LNMU160812-B57T	M	4	16	16,9	8	1,2		⊗				⊗	⊗						
 LNMU080304-F57T	M	4	8	9	3,5	0,4	⊕	⊗	⊗	⊗	⊗		⊕				⊗	⊗	
LNMU080404-F57T	M	4	9,4	8	4,5	0,4	⊕	⊗	⊗	⊗	⊗		⊕				⊗	⊗	
LNMU100508-F57T	M	4	12,3	10	5,5	0,8	⊕	⊗	⊗	⊗	⊗		⊕				⊗	⊗	
LNMU120608-F57T	M	4	13,9	12	6,5	0,8	⊕	⊗	⊗	⊗	⊗		⊕				⊗	⊗	
LNMU160812-F57T	M	4	16	16,9	8	1,2	⊕	⊗	⊗	⊗	⊗		⊕				⊗	⊗	

 HC = Coated carbide
 HW = Uncoated carbide

Tangential rhombic

Tiger-tec®

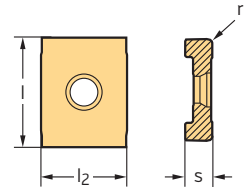

Indexable inserts

Designation	Tolerance class	Number of cutting edges	l ₂ mm	l mm	s mm	r mm	P			M		K			N		S		H
							HC			HC		HC			HC	HW	HC		HC
							WKP255	WKP355	WSP45	WSM35	WSP45	WAK15	WKK25	WKP255	WKP355	WXN15	WK10	WSM35	WSP45
LNHX070204-D57T	H	4	7	9	2,4	0,4	☹	☹			☹	☹	☹						
LNHX070204-F57T	H	4	7	9	2,4	0,4	☹	☹	☹	☹		☹	☹				☹	☹	
LNMX070204-D57T	M	4	7	9	2,4	0,4	☹	☹			☹	☹	☹						
LNMX070204-F57T	M	4	7	9	2,4	0,4	☹	☹	☹	☹		☹	☹				☹	☹	

HC = Coated carbide
HW = Uncoated carbide

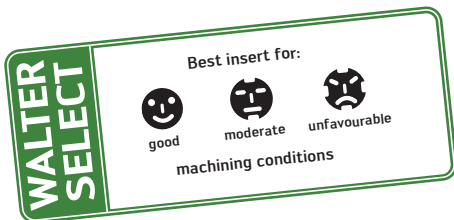

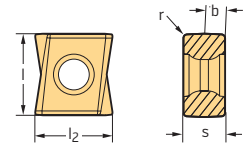

Tangential rhombic

Tiger-tec®



Indexable inserts

Designation	Tolerance class	Number of cutting edges	l ₂ mm	l mm	s mm	r mm	b mm	P			M		K			N		S		H
								HC			HC		HC			HW	HC	HC		HC
								WKP255	WKP355	WSP455	WSM355	WSP455	WAK15	WKK25	WKP255	WKP355	WK10	WXN15	WSM355	WSP455
 LNHU090404R-L55T	H	4	9	8,5	4,5	0,4	1,5	☺	☺	☺	☺	☺	☺	☺	☺	☺	☺	☺	☺	
LNHU090408R-L55T	H	4	9	8,5	4,5	0,8	1,1	☺	☺	☺	☺	☺	☺	☺	☺	☺	☺	☺	☺	
LNHU090412R-L55T	H	4	9	8,5	4,5	1,2	0,8	☺	☺	☺	☺	☺	☺	☺	☺	☺	☺	☺	☺	
LNHU090416R-L55T	H	4	9	8,5	4,5	1,6		☺	☺	☺	☺	☺	☺	☺	☺	☺	☺	☺	☺	
LNHU090420R-L55T	H	4	9	8,5	4,5	2		☺	☺	☺	☺	☺	☺	☺	☺	☺	☺	☺	☺	
LNHU130608R-L55T	H	4	13	12	6,8	0,8	2,2	☺	☺	☺	☺	☺	☺	☺	☺	☺	☺	☺	☺	
LNHU130612R-L55T	H	4	13	12	6,8	1,2	1,85	☺	☺	☺	☺	☺	☺	☺	☺	☺	☺	☺	☺	
LNHU130616R-L55T	H	4	13	12	6,8	1,6	1,5	☺	☺	☺	☺	☺	☺	☺	☺	☺	☺	☺	☺	
LNHU130620R-L55T	H	4	13	12	6,8	2	1,15	☺	☺	☺	☺	☺	☺	☺	☺	☺	☺	☺	☺	
LNHU130625R-L55T	H	4	13	12	6,8	2,5	0,7	☺	☺	☺	☺	☺	☺	☺	☺	☺	☺	☺	☺	
LNHU130630R-L55T	H	4	13	12	6,8	3		☺	☺	☺	☺	☺	☺	☺	☺	☺	☺	☺	☺	
LNHU130632R-L55T	H	4	13	12	6,8	3,2		☺	☺	☺	☺	☺	☺	☺	☺	☺	☺	☺	☺	
LNHU160708R-L55T	H	4	16	15,5	7,2	0,8	2,3	☺	☺	☺	☺	☺	☺	☺	☺	☺	☺	☺	☺	
LNHU160712R-L55T	H	4	16	15,5	7,2	1,2	1,9	☺	☺	☺	☺	☺	☺	☺	☺	☺	☺	☺	☺	
LNHU160716R-L55T	H	4	16	15,5	7,2	1,6	1,6	☺	☺	☺	☺	☺	☺	☺	☺	☺	☺	☺	☺	
LNHU160720R-L55T	H	4	16	15,5	7,2	2	1,2	☺	☺	☺	☺	☺	☺	☺	☺	☺	☺	☺	☺	
LNHU160725R-L55T	H	4	16	15,5	7,2	2,5		☺	☺	☺	☺	☺	☺	☺	☺	☺	☺	☺	☺	
 LNHU090404R-L85T	H	4	9	8,5	4,5	0,4	1,5									☺	☺			
LNHU130608R-L85T	H	4	13	12	6,8	0,8	2,2									☺	☺			
LNHU160708R-L85T	H	4	16	15,5	7,2	0,8	2,3									☺	☺			

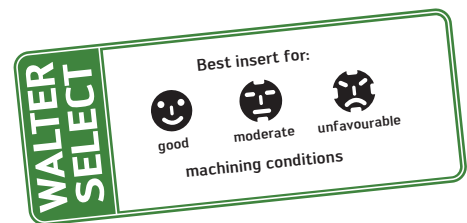
 HC = Coated carbide
 HW = Uncoated carbide

Positive rhombic

Tiger-tec®

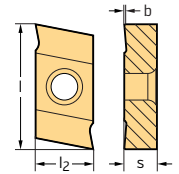

Indexable inserts

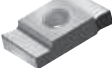
Designation	Tolerance class	Number of cutting edges	l ₂ mm	l mm	s mm	b mm	P		M		K		N		S		H
							HC		HC		HC		HC	HW	HC		HC
							WKP25S	WKP35S	WSP45	WSM35	WSP45	WAK15	WKK25	WKP25S	WKP35S	WXN15	WK10
 P20200-1.1	H	2	5,5	9	2,35	0,1	⊗	⊗									
P20200-1.2	H	2	5,5	9	2,35	0,15	⊗	⊗									
P20200-1.3	H	2	5,5	9	2,35	0,15	⊗	⊗									
P20200-1.4	H	2	5,5	9	2,35	0,15	⊗	⊗									
P20200-1.5	H	2	5,5	9	2,35	0,15	⊗	⊗									
P20200-2.1	H	2	7	12	3,4	0,15	⊗	⊗									
P20200-2.2	H	2	7	12	3,4	0,15	⊗	⊗									
P20200-2.3	H	2	7	12	3,4	0,15	⊗	⊗									

For the tolerance of the assembled tool, see page F 236 in the Walter General catalogue 2012.



HC = Coated carbide
HW = Uncoated carbide

Tangential rhombic

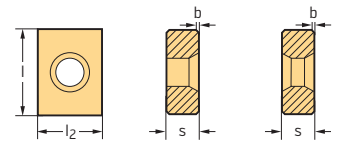
Tiger-tec®



Indexable inserts

Designation	Tolerance class	Number of cutting edges	l ₂ mm	l mm	s mm	b mm	P		M		K		N		S		H
							HC		HC		HC		HC	HW	HC		HC
							WKP25S	WKP35S	WSP45	WSM35	WSP45	WAK15	WKK25	WKP25S	WKP35S	WXN15	WK10
 P4406-1	H	2	9,52	12,7	3,5	0,5	⊗	⊗			⊗						
P4406-2	H	2	9,52	12,7	4	0,5	⊗	⊗			⊗						
P4406-3	H	4	9,52	12,7	4,76	0,4	⊗	⊗			⊗						
P4406-4	H	4	9,52	12,7	5,5	0,4	⊗	⊗			⊗						
P4406-5	H	4	9,52	12,7	6,35	0,4	⊗	⊗			⊗						
 P44462-1	H	2	9,52	12,7	3,5	0,5	⊗	⊗			⊗						
P44462-2	H	2	9,52	12,7	4	0,5	⊗	⊗			⊗						
P44462-3	H	4	9,52	12,7	4,76	0,4	⊗	⊗			⊗						
P44462-4	H	4	9,52	12,7	5,5	0,4	⊗	⊗			⊗						
P44462-5	H	4	9,52	12,7	6,35	0,4	⊗	⊗			⊗						



HC = Coated carbide
HW = Uncoated carbide

Tangential rhombic

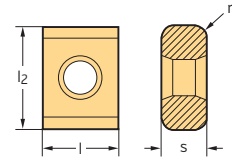
Tiger-tec®



Indexable inserts

Designation	Tolerance class	Number of cutting edges	l ₂ mm	l mm	s mm	r mm	P			M			K			N		S			H
							HC			HC			HC			HC	HW	HC			HC
							WKP25S	WKP35S	WSP45	WSM35	WSM35S	WSP45	WAK15	WKK25	WKP25S	WKP35S	WXN15	WK10	WSM35	WSM35S	WSP45
 P44280-1R08-D57	H	8	12,7	9,52	5,5	0,8															
P44280-1R10-D57	H	8	12,7	9,52	5,5	1															
P44280-1R125-D57	H	8	12,7	9,52	5,5	1,25															
P44280-1R15-D57	H	8	12,7	9,52	5,5	1,5															
P44280-1R20-D57	H	8	12,7	9,52	5,5	2															
P44280-2R25-D57	H	8	12,7	9,52	6,35	2,5															
P44280-2R30-D57	H	8	12,7	9,52	6,35	3															
P44280-2R40-D57	H	4	12,7	9,52	6,35	4															
 P44290-1R08-D57	M	8	12,7	9,52	5,5	0,8															
P44290-1R10-D57	M	8	12,7	9,52	5,5	1															
P44290-1R125-D57	M	8	12,7	9,52	5,5	1,25															
P44290-1R15-D57	M	8	12,7	9,52	5,5	1,5															
P44290-1R20-D57	M	8	12,7	9,52	5,5	2															
P44290-2R25-D57	M	8	12,7	9,52	6,35	2,5															
P44290-2R30-D57	M	8	12,7	9,52	6,35	3															
P44290-2R40-D57	M	4	12,7	9,52	6,35	4															

HC = Coated carbide
HW = Uncoated carbide

Negative square

Tiger-tec®

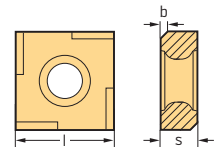

Indexable inserts

Designation	Tolerance class	Number of cutting edges	l mm	s mm	b mm	P			M			K			N		S			H	
						HC			HC			HC			HC	HW	HC			HC	
						WKP25S	WKP35S	WSP45	WSM35	WSP45	WAK15	WKK25	WKP25S	WKP35S	WXN15	WK10	WSM35	WSP45	WHH15		
 SNHQ1205ZZR-A57T	H	8	12	5	0,8																

HC = Coated carbide
HW = Uncoated carbide

New addition to range

Walter Cut SX inserts for slitting and cutting off

Tiger-tec®

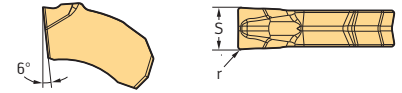

Indexable inserts

Designation	s mm	r mm	S _{Tol} mm	P		M		K		N		S		H	
				HC		HC		HC		HC	HW	HC		HC	HC
				WSM23S	WSM33S	WSM43S	WSM23S	WSM33S	WSM43S	WKP25S	WKP35S	WXN15	WK10	WSM23S	WSM33S
SX-2E200N02-CE4	2	0,2	± 0,05	⊕	⊕	⊕	⊕	⊕				⊕	⊕		
SX-3E300N02-CE4	3	0,2	± 0,05	⊕	⊕	⊕	⊕	⊕				⊕	⊕		
SX-4E400N02-CE4	4	0,2	± 0,05	⊕	⊕	⊕	⊕	⊕				⊕	⊕		
SX-2E200N02-CF5	2	0,2	± 0,05	⊕	⊕	⊕	⊕	⊕				⊕	⊕		
SX-3E300N02-CF5	3	0,2	± 0,05	⊕	⊕	⊕	⊕	⊕				⊕	⊕		
SX-4E400N02-CF5	4	0,2	± 0,05	⊕	⊕	⊕	⊕	⊕				⊕	⊕		
SX-2E200N02-CF6	2	0,2	± 0,05	⊕	⊕	⊕	⊕	⊕				⊕	⊕		
SX-3E300N02-CF6	3	0,2	± 0,05	⊕	⊕	⊕	⊕	⊕				⊕	⊕		

Radius tolerance $r_{Tol} = \pm 0.05$ mm

HC = Coated carbide
HW = Uncoated carbide

Finishing inserts

Tiger-tec®

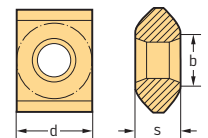

Indexable inserts

Designation	Tolerance class	Number of cutting edges	d mm	s mm	b mm	P		M		K		N		S		H	
						HC		HC		HC		HC	HW	HC		HC	HC
						WKP25S	WKP35S	WSP45	WSM35	WSP45	WAK15	WKK25	WKP25S	WKP35S	WXN15	WK10	WSM35
P45420-G67	G	4	9,52	4,76	7					⊕						⊕	⊕

HC = Coated carbide
HW = Uncoated carbide

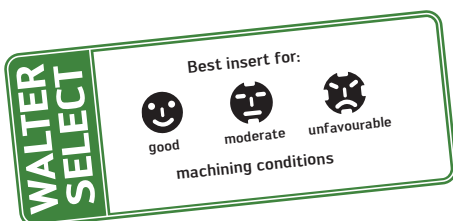

⊕ ⊕ ⊕ New addition to range

Product range overview of milling cutters with indexable inserts

Face/shoulder milling

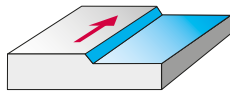

Walter Select, see page F-46

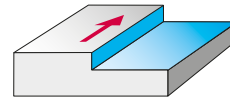

Walter Select, see page F-64

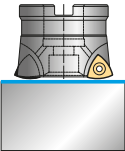
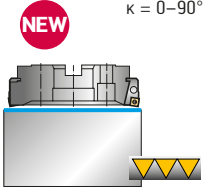
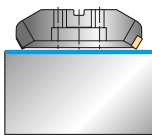
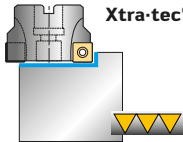
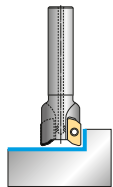
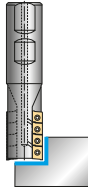
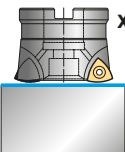
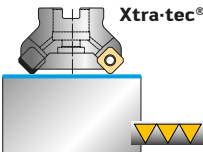
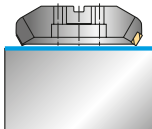
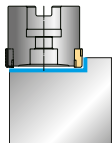
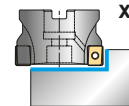
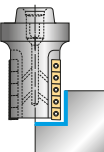
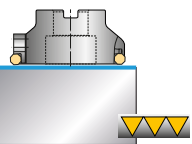
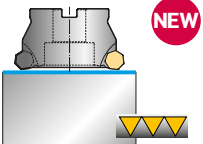
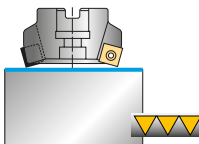
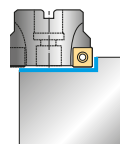
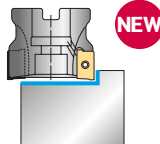
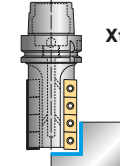
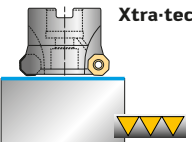
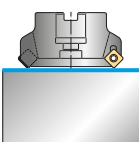
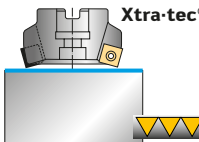
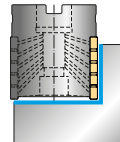
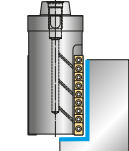
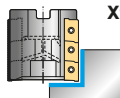
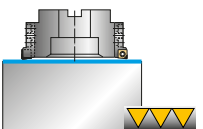
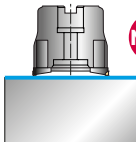
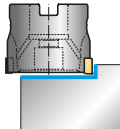
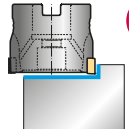
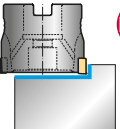
F 2330 <i>Page F 114*</i> $D_a = 20-85 \text{ mm}$ $\kappa = 0-15^\circ$ 	F 2010 <i>Page F-52 + page F 66*</i> $D_c = 80-315 \text{ mm}$ $\kappa = 0-90^\circ$ 	F 2260 <i>Page F 110*</i> $D_c = 100-315 \text{ mm}$ $\kappa = 60^\circ$ 	F 4048 <i>Page F 128*</i> $D_c = 40-200 \text{ mm}$ $\kappa = 88^\circ$ 	F 3040 <i>Page F 140*</i> $D_c = 25-63 \text{ mm}$ $\kappa = 90^\circ$ 	F 4038 <i>Page F 162*</i> $D_c = 20-32 \text{ mm}$ $\kappa = 90^\circ$ 
F 4030 <i>Page F 116*</i> $D_a = 25-100 \text{ mm}$ $\kappa = 0-21^\circ$ 	F 4033 <i>Page F 118*</i> $D_c = 40-200 \text{ mm}$ $\kappa = 45^\circ$ 	F 2265 <i>Page F 112*</i> $D_c = 125-315 \text{ mm}$ $\kappa = 60^\circ$ 	F 2254 <i>Page F 108*</i> $D_c = 50-160 \text{ mm}$ $\kappa = 89^\circ$ 	F 4041 <i>Page F 142*</i> $D_c = 40-160 \text{ mm}$ $\kappa = 90^\circ$ 	F 4138 <i>Page F 164*</i> $D_c = 32-80 \text{ mm}$ $\kappa = 90^\circ$ 
F 2146 <i>Page F 96*</i> $D_c = 80-250 \text{ mm}$ $\kappa = 43^\circ$ 	F 4045 <i>Page F-54</i> $D_c = 63-200 \text{ mm}$ $\kappa = 45^\circ$ 	F 2235 <i>Page F 102*</i> $D_c = 32-100 \text{ mm}$ $\kappa = 75^\circ$ 	F 2241 <i>Page F 138*</i> $D_c = 16-160 \text{ mm}$ $\kappa = 89^\circ/45^\circ$ 	F 4042 <i>Page F-68 + page F 144*</i> $D_c = 10-160 \text{ mm}$ $\kappa = 90^\circ$ 	F 4238 <i>Page F 166*</i> $D_c = 40-80 \text{ mm}$ $\kappa = 90^\circ$ 
F 4080 <i>Page F 130*</i> $D_a = 32-170 \text{ mm}$ $\kappa = 43^\circ$ 	F 2233 <i>Page F 98*</i> $D_c = 20-160 \text{ mm}$ $\kappa = 45^\circ$ 	F 4047 <i>Page F 126*</i> $D_c = 40-200 \text{ mm}$ $\kappa = 75^\circ$ 	F 5138 <i>Page F-78</i> $D_c = 40-80 \text{ mm}$ $\kappa = 90^\circ$ 	F 2338F <i>Page F 160*</i> $D_c = 63-100 \text{ mm}$ $\kappa = 90^\circ$ 	F 4338 <i>Page F 168*</i> $D_c = 63-125 \text{ mm}$ $\kappa = 90^\circ$ 
	F 2250 <i>Page F 104*</i> $D_c = 63-200 \text{ mm}$ $\kappa = 75^\circ + 90^\circ$ 	F 4050 <i>Page F-58</i> $D_c = 79.4-200 \text{ mm}$ $\kappa = 75^\circ + 90^\circ$ 	F 5041 <i>Page F-72</i> $D_c = 25-63 \text{ mm}$ $\kappa = 90^\circ$ 	F 5141 <i>Page F-74</i> $D_c = 40-125 \text{ mm}$ $\kappa = 90^\circ$ 	F 5241 <i>Page F-76</i> $D_c = 50-160 \text{ mm}$ $\kappa = 90^\circ$ 

* The pages indicated in italics refer to the Walter General catalogue 2012.

Slot milling		Copy milling		Profile milling		Circular interpolation milling	
<p>Walter Select, see page F-80</p>		<p>Walter Select, see page F-86</p>		<p>Walter Select see General catalogue page F 234</p>		<p>Walter Select, see General catalogue page F 242</p>	
<p>F 2238 Page F 176*</p> <p>$D_c = 20-125 \text{ mm}$ $\kappa = 90^\circ$</p>	<p>F 2252 Page F 186*</p> <p>$D_c = 80-315 \text{ mm}$ $\kappa = 90^\circ$</p>	<p>F 2139 Page F 214*</p> <p>$D_c = 8-32 \text{ mm}$</p>	<p>F 2231/A Page F 216*</p> <p>$D_a = 10-40 \text{ mm}$</p>	<p>F 2036 Page F 236*</p> <p>$D_c = 16-63 \text{ mm}$ $\kappa = 90^\circ$</p>	<p>F 4081 Page F 244*</p> <p>$D_a = 36-85 \text{ mm}$ $\kappa = 45^\circ$</p> <p>Xtra-tec®</p>	<p>F 2234 Page F 218*</p> <p>$D_a = 12-160 \text{ mm}$</p>	
<p>F 2338 Page F 184*</p> <p>$D_c = 63-100 \text{ mm}$ $\kappa = 90^\circ$</p>	<p>F 5055 Page F-84</p> <p>$D_c = 63-250 \text{ mm}$ $\kappa = 90^\circ$</p> <p>Walter BLAXX NEW</p>	<p>F 2239 B Page F 226*</p> <p>$D_c = 20-50 \text{ mm}$</p>	<p>F 2234 Page F 218*</p> <p>$D_a = 12-160 \text{ mm}$</p>	<p>F 2243 Page F 240*</p> <p>$D_c = 21-50 \text{ mm}$ $\kappa = 90^\circ$</p>	<p>F 4080 Page F 130*</p> <p>$D_a = 32-170 \text{ mm}$ $\kappa = 43^\circ$</p> <p>Xtra-tec®</p>	<p>F 2334 Page F 222*</p> <p>$D_a = 25-160 \text{ mm}$</p>	
<p>F 2237 Page F 174*</p> <p>$D_c = 18-40 \text{ mm}$ $\kappa = 90^\circ$</p>	<p>F 4053 Page F 200*</p> <p>$D_c = 80-160 \text{ mm}$ $\kappa = 90^\circ$</p> <p>Xtra-tec®</p>	<p>F 2339 Page F 228*</p> <p>$D_c = 16-50 \text{ mm}$</p>	<p>F 2334 Page F 222*</p> <p>$D_a = 25-160 \text{ mm}$</p>	<p>F 2232 Page F 238*</p> <p>$D_c = 12-40 \text{ mm}$ $\kappa = 45^\circ$</p>	<p>F 2330 Page F 114*</p> <p>$D_a = 20-85 \text{ mm}$ $\kappa = 0^\circ-15^\circ$</p>	<p>F 3040 Page F 140*</p> <p>$D_c = 25-63 \text{ mm}$ $\kappa = 90^\circ$</p>	
<p>F 2330 Page F 114*</p> <p>$D_a = 20-85 \text{ mm}$ $\kappa = 0^\circ-15^\circ$</p>	<p>F 4153 Page F 204*</p> <p>$D_c = 80-200 \text{ mm}$ $\kappa = 90^\circ$</p> <p>Xtra-tec®</p>	<p>F 4031 Page F-90</p> <p>$D_c = 12-32 \text{ mm}$ $\kappa = 90^\circ$</p> <p>Xtra-tec® NEW</p>	<p>F 2334R Page F-88</p> <p>$D_a = 25-63 \text{ mm}$</p>		<p>F 4030 Page F 116*</p> <p>$D_a = 25-100 \text{ mm}$ $\kappa = 0^\circ-21^\circ$</p> <p>Xtra-tec®</p>	<p>F 4042 Page F 144*</p> <p>$D_c = 10-160 \text{ mm}$ $\kappa = 90^\circ$</p> <p>Xtra-tec®</p>	
<p>F 4030 Page F 116*</p> <p>$D_a = 25-100 \text{ mm}$ $\kappa = 0^\circ-21^\circ$</p> <p>Xtra-tec®</p>	<p>F 4253 Page F 208*</p> <p>$D_c = 100-315 \text{ mm}$ $\kappa = 90^\circ$</p> <p>Xtra-tec®</p>				<p>F 2334R Page F-88</p> <p>$D_a = 25-63 \text{ mm}$</p> <p>NEW</p>		

Walter Select – Face milling

Machining			
Lead angle κ	43°	45°	45°
Face milling cutter	F 2146 	F 2233 	F 4033 Xtra-tec®
Ø range	80–250	20–160	40–200
Page	<i>F 96*</i>	<i>F 98*</i>	<i>F 118*</i>
P Steel	•	••	••
M Stainless steel	•	••	••
K Cast iron	••	••	••
N NF metals		••	••
S Difficult-to-machine materials	•	••	••
H Hard materials	•	•	•
O Other		•	•
Basic insert shape			
Insert types	OP .. 0504 ..	SD .. 09T3 .. SP .. 1204 ..	SN . X 1205 .. SN . X 1606 ..
Max. cutting depths [mm]	3 / 8	5 + 7	6,5 + 9
Number of cutting edges per indexable insert	8	4	8

* The pages indicated in italics refer to the Walter General catalogue 2012.



	75° + 90°	75° + 90°	75°	75°	88°
	F 2250	NEW F 4050	F 2235	F 4047	F 4048
	63-200	79,4-200	32-100	40-200	40-200
	<i>F 104*</i>	F-58	<i>F 102*</i>	<i>F 126*</i>	<i>F 128*</i>
			••	••	••
			••	••	••
			••	••	••
	••	••	••	•	•
			••	••	••
			•		
	SP...1204...	FR 733 FR 734	SP...1204...	SN...X 1205...	SN...X 1205...
	3 + 4	1,1 + 4	10	8	10
	1	1	4	8	8



Walter Select – Face milling

Machining					
Lead angle k	45°	60°	60°	89°	
Face milling cutter					
Ø range [mm]	63–200	100–315	125–315	50–160	
Page	F-54	<i>F 110*</i>	<i>F 112*</i>	<i>F 108*</i>	
P Steel	•	•	••		
M Stainless steel			•		
K Cast iron	••	••	•	••	
N NF metals					
S Difficult-to-machine materials			•		
H Hard materials					
O Other					
Basic insert shape					
Insert types	XNHF 0705 .. XNHF 0906 ..	LNMU 1508 .. LNMU 2010 ..	LNKU 2010 .. LNKU 3010 ..	SNHQ 1205 ..	
Max. cutting depths [mm]	4 + 6	11 + 15	12 + 20	7	
Number of cutting edges per indexable insert	14	4	4	8	

* The pages indicated in italics refer to the Walter General catalogue 2012.

<p>43°</p>	<p>0-15°</p>	<p>0-21°</p>
<p>F 4080</p> <p>Xtra-tec®</p>	<p>F 2330</p>	<p>F 4030</p> <p>Xtra-tec®</p>
<p>32-170</p>	<p>20-85</p>	<p>25-100</p>
<p><i>F 130*</i></p>	<p><i>F 114*</i></p>	<p><i>F 116*</i></p>
<p>••</p>	<p>••</p>	<p>••</p>
<p>••</p>	<p>••</p>	<p>••</p>
<p>••</p>	<p>••</p>	<p>••</p>
<p>••</p>	<p>••</p>	<p>••</p>
<p>••</p>	<p>••</p>	<p>••</p>
<p>•</p>	<p>•</p>	<p>•</p>
<p>•</p>	<p>•</p>	<p>•</p>
<p>OD .. 0504 .. OD .. 0605 ..</p>	<p>P 2633 . P 26379</p>	<p>P 23696 - 1,0 P 23696 - 2,0</p>
<p>3 / 8 + 4 / 10</p>	<p>1 + 1,5 + 2</p>	<p>1 + 2</p>
<p>8</p>	<p>3</p>	<p>6</p>

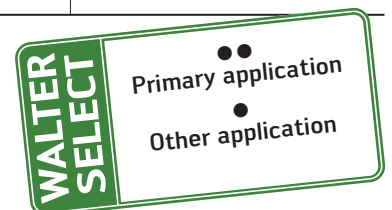

Walter Select – Face milling

Machining				
Roughing	▲	▲	▲	
Finish end milling	▲	▲	▲	
Shoulder milling				▲
Shoulder milling (finishing)				▲
Plunging				
Circular interpolation milling				
Pocket milling				
Lead angle K	45°	75°	45° / 75° / 88°	89°45'
Face milling cutter	F 2010 			
Ø range [mm]	80–315	80–315	80–315	80–315
Page	F 76*	F 80*	F 72–75, F 78, F 82*	F 84*
P Steel	●●	●●	●●	●●
M Stainless steel	●●	●●	●●	●●
K Cast iron	●●	●●	●●	●●
N NF metals	●●	●●	●●	●●
S Difficult-to-machine materials	●	●	●●	●
H Hard materials	●		●	●
O Other	●	●	●	●
Basic insert shape				
Insert types	SP..1204..	SP..1204..	SN..1205.. SN..1606..**	SP..1204..
Max. cutting depths [mm]	6 + 7	10	6,5 + 8 + 9 + 10	11
Number of cutting edges per indexable insert	4	4	8	4

** SN .. 1606 .. for 45° lead only

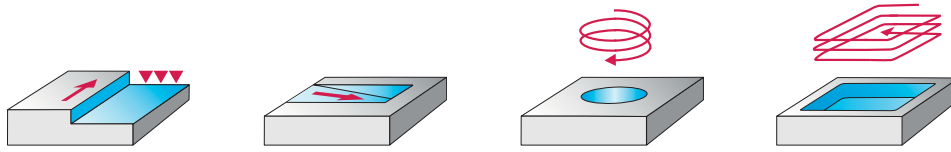

				▲	▲	▲	▲
						▲	▲
	▲	▲					
	▲	▲	▲				
		▲		▲	▲	▲	▲
		▲		▲	▲	▲	▲
		▲		▲	▲	▲	▲
	90°	90°	90°	0-15°	0-21°	43° / 45°	—

F 2010

NEW

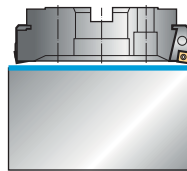

	80-315	80-315	80-315	70-305	70,5-305,6	80-315	74-309
	<i>F 92*</i>	<i>F 86-89*</i>	<i>F 90*</i>	<i>F 66*</i>	F-52	<i>F 68-71*</i>	<i>F 94*</i>
	●●	●●	●●	●●	●●	●●	●●
	●●	●●	●	●●	●●	●●	●●
	●●	●●	●●	●●	●●	●●	●●
	●●	●●				●●	●
	●●	●●		●●	●●	●●	●●
	●	●		●			●
	●	●				●	
	LNGX 1307 ..	AD .. 1204 .. AD .. 1606 ..	P 2903 ..	P 2633 ..-R25 P 26379-R25	P 23696-2,0	OD .. 0605 ..	RO . X 1605 ..
	13	11,7 + 15	1 / 9	2	2	2 + 4 / 10	8
	4	2	3	3	6	8	6

* The pages indicated in italics refer to the Walter General catalogue 2012.

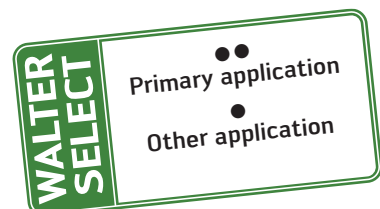

Face milling cutter F 2010

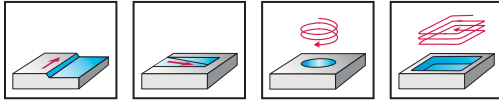

- Approach angle $\kappa = 0 - 21^\circ$
- Six cutting edges per indexable insert
- Negative basic insert shapes
- f_z up to 3.5 mm
- Runout adjustable

Tool	Designation	D_c mm	D_a mm	d_1 mm	l_4 mm	L_c mm	Z	kg	No. of indexable inserts	Type
Cyl. bore DIN 138 longitudinal key way 	★ F2010.B.080.Z06.02.R750M	70,5	90,2	27	50	2	6	1,2	6	P 23696 - 2.0
	★ F2010.B.100.Z07.02.R750M	90,1	109,9	32	50	2	7	1,9	7	
	★ F2010.B.125.Z08.02.R750M	115,2	134,9	40	63	2	8	3,6	8	
Cyl. bore DIN 138 longitudinal key way 	★ F2010.B.160.Z10.02.R750M	150,4	170,2	40/40 B	63	2	10	5,6	10	P 23696 - 2.0
Cyl. bore DIN 138 longitudinal key way 	★ F2010.B.200.Z12.02.R750M	190,6	210,2	60/50 B	63	2	12	8,3	12	P 23696 - 2.0
	★ F2010.B.250.Z12.02.R750M	240,6	260,2	60/50 B	63	2	12	14,8	12	
	★ F2010.B.250.Z16.02.R750M	240,6	260,2	60/50 B	63	2	16	14,6	16	
Cyl. bore DIN 138 longitudinal key way 	★ F2010.B.315.Z14.02.R750M	305,6	325,2	60/50-60 BB	80	2	14	26,3	14	P 23696 - 2.0
	★ F2010.B.315.Z18.02.R750M	305,6	325,2	ISO 60/50-60BB	80	2	18	26,2	18	

Bodies and assembly parts are included in the scope of delivery.

★ New addition to range

Assembly parts

		D _c mm	70,5-305,6
	Cartridge for tool body		FR750M
	Clamping screw for cartridge Tightening torque		FS247 (SW 4) 8,0 Nm
	Clamping screw for indexable insert		FS1031 (Torx 20)
	Adjusting pin		FS303 (Torx 20)

Accessories

		D _c mm	70,5-305,6
	Screwdriver for indexable insert		FS228 (Torx 20)
	Screwdriver for adjusting pin		FS228 (Torx 20)
	Allen key ISO 2936 for cartridge		ISO2936-4 (SW 4)

Indexable inserts

	Radius mm	P			M			K			N		S			H
		HC			HC			HC			HC	HW	HC			HC
		WKP25S	WKP35S	WSP45	WSM35	WSM35S	WSP45	WAK15	WKK25	WKP25S	WKP35S	WXN15	WK10	WSM35	WSM35S	WSP45
	P23696-2.0	1,6	☺	☹	☹	☹				☹			☹	☹	☹	

HC = Coated carbide
HW = Uncoated carbide

WALTER SELECT

Best insert for:

☺
good

☹
moderate

☹
unfavourable

machining conditions

Heptagon cutter F 4045 XNHF 0705 . .

Xtra-tec®

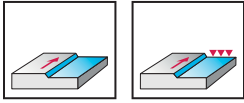

- Approach angle $\kappa = 45^\circ$
- Fourteen cutting edges per indexable insert
- Negative basic insert shapes
- Wiper finishing inserts available

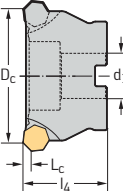
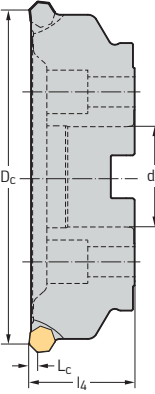
Tool	Designation	D _c mm	d ₁ mm	l ₄ mm	L _c mm	Z	kg	No. of indexable inserts	Type
Cyl. bore DIN 138 longitudinal key way 	★ F4045.B27.063.Z06.04	63	27	50	4	6	0,7	6	XNHF 0705 . .
	F4045.B27.063.Z09.04	63	27	50	4	9	0,7	9	
	★ F4045.B27.080.Z08.04	80	27	50	4	8	1,1	8	
	F4045.B27.080.Z11.04	80	27	50	4	11	1,4	11	
	★ F4045.B32.100.Z10.04	100	32	50	4	10	1,8	10	
	F4045.B32.100.Z14.04	100	32	50	4	14	1,8	14	
Cyl. bore DIN 138 longitudinal key way 	★ F4045.B40.125.Z12.04	125	40	63	4	12	3,3	12	XNHF 0705 . .
	F4045.B40.125.Z18.04	125	40	63	4	18	3,2	18	
	★ F4045.B40.160.Z16.04	160	40/40B	63	4	16	5,5	16	
	F4045.B40.160.Z22.04	160	40/40B	63	4	22	5,7	22	
	★ F4045.B60.200.Z20.04	200	6050/B	63	4	20	9,3	20	
	F4045.B60.200.Z28.04	200	6050/B	63	4	28	9,5	28	

Bodies and assembly parts are included in the scope of delivery.

Roughing/finishing combination

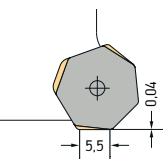
$\kappa = 45^\circ$	Roughing	Finishing
	Indexable insert XNHF 070508 . .	Indexable insert XNHX 0705 . .

★ New addition to range

Assembly parts

		D _c mm	63-200
	Clamping wedge		FK374
	Clamping screw for clamping wedge		FS2134 (Torx 15IP)
	Tightening torque		6,0 Nm

Accessories

		D _c mm	63-200
	Torque T-handle		FS2041
	Interchangeable blade for clamping wedge		FS2047 (Torx 15IP)
	Screwdriver		FS1485 (Torx 15IP)

Indexable inserts

		Radius mm	Face chamfer width mm	P		M		K			N		S		H
				HC		HC		HC			HC	HW	HC		HC
				WKP255	WKP355	WSP45	WSM35	WSP45	WAK15	WKK25	WKP255	WKP355	WXN15	WK10	WSM35
	XNHF070508-D27	0.8		☹	☹					☹	☹				
	XNHF070508-D57	0.8		☹	☹				☹	☹					
	XNHF070508-D67	0.8		☹	☹			☹	☹	☹					
	XNHF0705ANN-D27	0.8	1.1		☹					☹					
	XNHF0705ANN-D57	0.8	1.1	☹	☹				☹	☹					
	XNHF0705ANN-D67	0.8	1.1	☹	☹			☹	☹	☹					
	XNHX0705ANN-D67*	0.8	5.5					☹							☹

* Only in combination with XNHF070508.

HC = Coated carbide
HW = Uncoated carbide

WALTER SELECT

Best insert for:

good

moderate

unfavourable

machining conditions

Heptagon cutter F 4045 XNHF 0906 . .

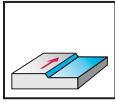
Xtra-tec®

- Approach angle $\kappa = 45^\circ$
- Fourteen cutting edges per indexable insert
- Negative basic insert shapes

Tool	Designation	D _c mm	d ₁ mm	l ₄ mm	L _c mm	Z	kg	No. of indexable inserts	Type
Cyl. bore DIN 138 longitudinal key way 	★ F4045.B27.080.Z06.06	80	27	50	6	6	1,2	6	XNHF 0906 . .
	F4045.B27.080.Z09.06	80	27	50	6	9	1,4	9	
	★ F4045.B32.100.Z08.06	100	32	50	6	8	1,8	8	
	F4045.B32.100.Z12.06	100	32	50	6	12	1,9	12	
	★ F4045.B40.125.Z10.06	125	40	50	6	10	3,1	10	
	F4045.B40.125.Z16.06	125	40	50	6	16	3,5	16	
Cyl. bore DIN 138 longitudinal key way 	★ F4045.B40.160.Z12.06	160	40	63	6	12	6,1	12	XNHF 0906 . .
	F4045.B40.160.Z20.06	160	40	63	6	20	6,2	20	
	★ F4045.B60.200.Z16.06	200	ISO 60/50B	63	6	16	9,3	16	
	F4045.B60.200.Z26.06	200	ISO 60/50B	63	6	26	9,9	26	

Bodies and assembly parts are included in the scope of delivery.

★ New addition to range

Assembly parts

D _c mm		80-200
	Clamping wedge	FK375
	Clamping screw for clamping wedge Tightening torque	FS2157 (Torx 25IP) 6,0 Nm

Accessories

D _c mm		80-200
	Torque T-handle	FS2041
	Interchangeable blade for clamping wedge	FS2049 (Torx 25IP)
	Screwdriver	FS1487 (Torx 25IP)

Indexable inserts

		Radius mm	Face chamfer width mm	P		M		K			N		S		H
				HC		HC		HC			HC	HW	HC		HC
				WKP255	WKP355	WSP45	WSM35	WSP45	WAK15	WKK25	WKP255	WKP355	WXN15	WK10	WSM35
	XNHF090612-D27	1,2		☹	☹					☹	☹				
	XNHF090612-D57	1,2		☹	☹				☹	☹	☹				
	XNHF090612-D67	1,2		☹	☹				☹	☹	☹				
	XNHF0906ANN-D27	0,8	1,4	☹	☹					☹	☹				
	XNHF0906ANN-D57	0,8	1,4	☹	☹				☹	☹	☹				
	XNHF0906ANN-D67	0,8	1,4		☹				☹	☹	☹				

HC = Coated carbide
HW = Uncoated carbide

WALTER SELECT

Best insert for:

good

moderate

unfavourable

machining conditions

PCD milling cutter F 4050

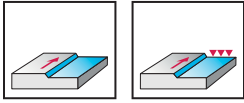

- Approach angle $\kappa = 75^\circ$
- 1 cutting edge per cartridge
- Cartridge with brazed PCD insert
- Runout adjustable
- For aluminium machining

Tool	Designation	D _c mm	d ₁ mm	l ₄ mm	L _c mm	Z	kg	No. of cartridges	Type
Cyl. bore DIN 138 longitudinal key way 	★ F4050.B27.080.Z06.R734	79,4	27	73	1,1	6	0,9	6	FR734
	★ F4050.B32.100.Z12.R734	99,4	32	63	1,1	12	1,4	12	
	★ F4050.B40.125.Z18.R734	124,4	40	63	1,1	18	2	18	
Cyl. bore DIN 138 longitudinal key way 	★ F4050.B40.160.Z24.R734	159,4	ISO 40/40B	63	1,1	24	3,7	24	FR734
	★ F4050.B40.200.Z28.R734	199,4	ISO 40/40B	63	1,1	28	5,4	28	

Bodies and assembly parts are included in the scope of delivery.

Pre-balanced to G6.3 where $n = 10,000$ rpm

For information on high-speed applications, see page F-122.

Roughing/finishing combination

$\kappa = 75^\circ$	Roughing	Finishing
	Cartridge FR 734 WCD 10	Cartridge FR 735 WCD 10

★ New addition to range

Assembly parts

	D _c mm	79,4	99,4	124,4	159,4-199,4
	Cartridge $\kappa = 75^\circ$	FR734 WCD10	FR734 WCD10	FR734 WCD10	FR734 WCD10
	Chip deflector	FR749	FR749	FR749	FR749
	Adjusting key	FK376	FK376	FK376	FK376
	Clamping screw for chip deflector Tightening torque	FS379 (Torx 8) 1,0 Nm	FS379 (Torx 8) 1,0 Nm	FS379 (Torx 8) 1,0 Nm	FS379 (Torx 8) 1,0 Nm
	Compound screw for adjusting key	FS746	FS746	FS746	FS746
	Spring washer	FS2171	FS2171	FS2171	FS2171
	Clamping screw for cartridge Tightening torque	FS2170 9,0 Nm	FS2170 9,0 Nm	FS2170 9,0 Nm	FS2170 9,0 Nm
	Balancing screw	FS2169 (Torx 15)	FS2169 (Torx 15)	FS2169 (Torx 15)	FS2169 (Torx 15)
	Milling cutter tightening screw with internal cooling	FS2160	FS2161	FS2162	

Accessories

	D _c mm	79,4	99,4	124,4	159,4-199,4
	Wrench for milling cutter tightening screw	FS438	FS439	FS440	
	Screwdriver for compound screw	FS1485 (Torx 15IP)	FS1485 (Torx 15IP)	FS1485 (Torx 15IP)	FS1485 (Torx 15IP)
	Screwdriver for balancing screw	FS229 (Torx 15)	FS229 (Torx 15)	FS229 (Torx 15)	FS229 (Torx 15)
	Screwdriver for chip deflector	FS230 (Torx 8)	FS230 (Torx 8)	FS230 (Torx 8)	FS230 (Torx 8)
	Torque T-handle for cartridge	FS2041	FS2041	FS2041	FS2041
	Interchangeable blade for cartridge	FS2051 (SW 4)	FS2051 (SW 4)	FS2051 (SW 4)	FS2051 (SW 4)
	Torque screwdriver for chip deflector	FS2001	FS2001	FS2001	FS2001
	Interchangeable blade for chip deflector	FS2007 (Torx 8)	FS2007 (Torx 8)	FS2007 (Torx 8)	FS2007 (Torx 8)
	Sealing disc set				FS2140 COMPLETE SET
	Gasket				O-R 96X4
	Finishing cartridge only for $\kappa = 75^\circ$	FR735 WCD10			

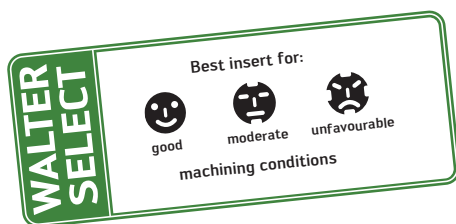

G-2



F-121



F-92

PCD milling cutter F 4050

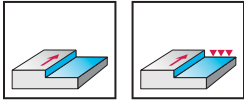

- Approach angle $\kappa = 90^\circ$
- 1 cutting edge per cartridge
- Cartridge with brazed PCD insert
- Runout adjustable
- For aluminium machining

Tool	Designation	D _c mm	d ₁ mm	l ₄ mm	L _c mm	Z	kg	No. of cartridges	Type
Cyl. bore DIN 138 longitudinal key way 	★ F4050.B27.080.Z06.R733	80	27	73	4	6	0,9	6	FR733
	★ F4050.B32.100.Z12.R733	100	32	63	4	12	1,4	12	
	★ F4050.B40.125.Z18.R733	125	40	63	4	18	2	18	
Cyl. bore DIN 138 longitudinal key way 	★ F4050.B40.160.Z24.R733	160	ISO 40/40B	63	4	24	3,7	24	FR733
	★ F4050.B40.200.Z28.R733	200	ISO 40/40B	63	4	28	5,4	28	







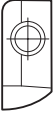

Bodies and assembly parts are included in the scope of delivery.

Pre-balanced to G6.3 where n = 10,000 rpm











For information on high-speed applications, see page F-122.

★ New addition to range

Assembly parts

D _c mm	80	100	125	160-200
 Cartridge $\kappa = 90^\circ$	FR733 WCD10	FR733 WCD10	FR733 WCD10	FR733 WCD10
 Chip deflector	FR749	FR749	FR749	FR749
 Adjusting key	FK376	FK376	FK376	FK376
 Clamping screw for chip deflector Tightening torque	FS379 (Torx 8) 1,0 Nm	FS379 (Torx 8) 1,0 Nm	FS379 (Torx 8) 1,0 Nm	FS379 (Torx 8) 1,0 Nm
 Compound screw for adjusting key	FS746	FS746	FS746	FS746
 Spring washer	FS2171	FS2171	FS2171	FS2171
 Clamping screw for cartridge Tightening torque	FS2170 9,0 Nm	FS2170 9,0 Nm	FS2170 9,0 Nm	FS2170 9,0 Nm
 Balancing screw	FS2169 (Torx 15)	FS2169 (Torx 15)	FS2169 (Torx 15)	FS2169 (Torx 15)
 Milling cutter tightening screw with internal cooling	FS2160	FS2161	FS2162	

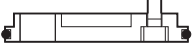
Accessories

D _c mm	80	100	125	160-200
 Wrench for milling cutter tightening screw	FS438	FS439	FS440	
 Screwdriver for compound screw	FS1485 (Torx 15IP)	FS1485 (Torx 15IP)	FS1485 (Torx 15IP)	FS1485 (Torx 15IP)
 Screwdriver for balancing screw	FS229 (Torx 15)	FS229 (Torx 15)	FS229 (Torx 15)	FS229 (Torx 15)
 Screwdriver for chip deflector	FS230 (Torx 8)	FS230 (Torx 8)	FS230 (Torx 8)	FS230 (Torx 8)
 Torque T-handle for cartridge	FS2041	FS2041	FS2041	FS2041
 Interchangeable blade for cartridge	FS2051 (SW 4)	FS2051 (SW 4)	FS2051 (SW 4)	FS2051 (SW 4)
 Torque screwdriver for chip deflector	FS2001	FS2001	FS2001	FS2001
 Interchangeable blade for chip deflector	FS2007 (Torx 8)	FS2007 (Torx 8)	FS2007 (Torx 8)	FS2007 (Torx 8)
 Sealing disc set				FS2140 COMPLETE SET
 Gasket				O-R 96X4

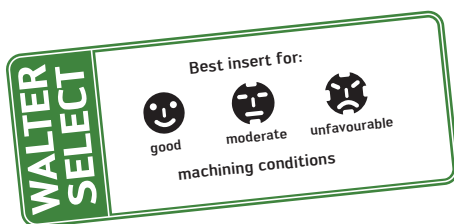

G-2



F-121



F-92

PCD milling cutter F 4050

Basic body without cartridges





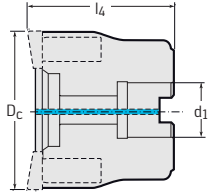
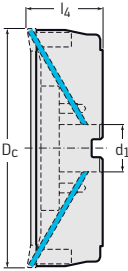









- Basic body for aluminium milling cutter F4050
- Without cartridges

Tool	Designation	D _c mm	d ₁ mm	l ₄ mm	Z	kg	No. of cartridge seats
Cyl. bore DIN 138 longitudinal key way 	★ F4050.B27.080.Z06.R001	80	27	73	6	0,8	6
	★ F4050.B32.100.Z12.R001	100	32	63	12	1	12
	★ F4050.B40.125.Z18.R001	125	40	63	18	1,5	18
Cyl. bore DIN 138 longitudinal key way 	★ F4050.B40.160.Z24.R001	160	ISO 40/40B	63	24	2,9	24
	★ F4050.B40.200.Z28.R001	200	ISO 40/40B	63	28	4,5	28

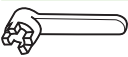
Bodies and assembly parts are included in the scope of delivery.
 Pre-balanced to G6.3 where n = 10,000 rpm
 For information on high-speed applications, see page F-122.

★ New addition to range

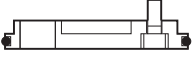
Assembly parts		D _c mm	80	100	125	160-200
	Adjusting key		FK376	FK376	FK376	FK376
	Compound screw for adjusting key		FS746	FS746	FS746	FS746
	Spring washer		FS2171	FS2171	FS2171	FS2171
	Clamping screw for cartridge		FS2170	FS2170	FS2170	FS2170
	Tightening torque		9,0 Nm	9,0 Nm	9,0 Nm	9,0 Nm
	Balancing screw		FS2169 (Torx 15)	FS2169 (Torx 15)	FS2169 (Torx 15)	FS2169 (Torx 15)
	Milling cutter tightening screw with internal cooling		FS2160	FS2161	FS2162	

Accessories		D _c mm	80	100	125	160-200
	Wrench for milling cutter tightening screw		FS438	FS439	FS440	
	Screwdriver for compound screw		FS1485 (Torx 15IP)	FS1485 (Torx 15IP)	FS1485 (Torx 15IP)	FS1485 (Torx 15IP)
	Screwdriver for balancing screw		FS229 (Torx 15)	FS229 (Torx 15)	FS229 (Torx 15)	FS229 (Torx 15)
	Torque T-handle for cartridge		FS2041	FS2041	FS2041	FS2041
	Interchangeable blade for cartridge		FS2051 (SW 4)	FS2051 (SW 4)	FS2051 (SW 4)	FS2051 (SW 4)
	Sealing disc set					FS2140 COMPLETE SET
	Gasket					O-R 96X4

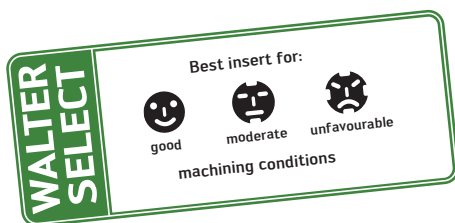

Walter Select – Shoulder milling

Machining				
Lead angle K	89°45'	90°		90°
Shoulder milling cutter	F 2241	F 4041	F 5041	F 5141
		Xtra-tec®	Walter BLAXX	Walter BLAXX
Ø range [mm]	16–160	40–160	25–63	40–125
Page	<i>F 138*</i>	<i>F 142*</i>	F-72	F-74
P Steel	••	••	••	••
M Stainless steel	••	••	••	••
K Cast iron	••	••	••	••
N NF metals	••	••	••	••
S Difficult-to-machine materials	••	••	••	••
H Hard materials	•			
O Other	•	•	•	•
Basic insert shape				
Insert types	SP .. 0603 .. SP .. 09T3 .. SP .. 1204 ..	LN GX 1307 ..	LN HU 0904 ..	LN HU 1306 ..
Max. cutting depths [mm]	6 + 9 + 12	13	8	12
Number of cutting edges per indexable insert	4	4	4	4

* The pages indicated in italics refer to the Walter General catalogue 2012.

90°	90°	90°	90°	
F 5241	F 4042R	F 4042	F 3040	
<p>Walter BLAXX</p>	<p>Xtra-tec®</p>	<p>Xtra-tec®</p>		
50-160	16-63	10-160	25-63	
F-76	F 148*	F-68 + F 144* / F 152*	F 140*	
●●	●●	●●	●	
●●	●●	●●	●	
●●	●●	●●	●	
●●	●●	●●	●●	
●●	●●	●●	●	
●	●	●	●	
●	●	●	●	
LNHU 1607 ..	AD . T 10T3 ..	AD . T 0803 .. AD . T 1204 .. AD . T 1606 .. AD . T 1807 ..	ZDGT 1504 .. ZDGT 2005 ..	
15	10	8 + 11,7 + 15 + 16	15 + 20	
4	2	2	2	



Walter Select – Shoulder milling

Machining			
Lead angle k	90°	90°	90°
Shoulder milling cutter	F 2338F 	F 4038 Xtra-tec®	F 4138 Xtra-tec®
Ø range [mm]	63–100	20–32	32–80
Page	<i>F 160*</i>	<i>F 162*</i>	<i>F 164*</i>
P Steel	••	••	••
M Stainless steel	•	••	••
K Cast iron	••	••	••
N NF metals	•	••	••
S Difficult-to-machine materials	•	••	••
H Hard materials			
O Other		•	•
Basic insert shape			
Insert types	LP .. 1506 .. SP .. 1206 ..	AD .. 0803 ..	AD .. 1204 ..
Max. cutting depths [mm]	103	37	76
Number of cutting edges per indexable insert	2 / 4	2	2

* The pages indicated in italics refer to the Walter General catalogue 2012.

	90°		90°	90°
	F 4238		F 4338	F 5138
	<p>Xtra-tec®</p>		<p>Xtra-tec®</p>	<p>Walter BLAXX</p>
	40-80		63-125	40-80
	F 166*		F 168*	F-78
	••		••	••
	••		••	••
	••		••	••
	••		•	••
	••		••	••
	•			•
	AD .. 1606 ..		AD .. 1807 ..	LNHU 1306 ..
	112		124	56
	2		2	4

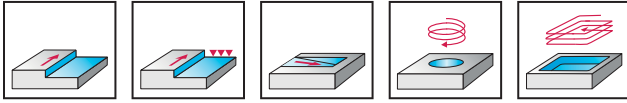

Shoulder milling cutter F 4042 AD .. 1606 ..

Xtra-tec®

- Approach angle $\kappa = 90^\circ$
- Two cutting edges per indexable insert
- Positive basic insert shape

Tool	Designation	D _c mm	d ₁ mm	l ₄ mm	L _c mm	l ₁ mm	Z	kg	No. of indexable inserts	Type
NCT ScrewFit 	★ F4042.T28.032.Z03.15*	32	T28	40	15		3	0,17	3	AD .. 1606 ..
	★ F4042.T28.036.Z03.15*	36	T28	40	15		3	0,2	3	
	F4042.T36.040.Z03.15*	40	T36	40	15		3	0,15	3	
	F4042.T36.040.Z04.15*	40	T36	40	15		4	0,32	4	
	★ F4042.T36.044.Z03.15*	44	T36	40	15		3	0,34	3	
	F4042.T45.050.Z03.15*	50	T45	40	15		3	0,46	3	
	F4042.T45.050.Z05.15*	50	T45	40	15		5	0,46	5	
Shank DIN 1835-B 	★ F4042.W25.025.Z02.15	25	25	43	15	100	2	0,3	2	AD .. 1606 ..
	★ F4042.W32.032.Z03.15	32	32	49	15	110	3	0,6	3	
Parallel shank without flat 	★ F4042.Z25.025.Z02.15	25	25	38	15	200	2	0,7	2	AD .. 1606 ..
	★ F4042.Z32.032.Z03.15	32	32	38	15	250	3	1,4	3	

Bodies and assembly parts are included in the scope of delivery.

For flat wrenches for screw heads, see page G 105 of the Walter General catalogue 2012.

* Balanced construction to G 6.3 at 10,000 rpm.

★ New addition to range

Assembly parts

D _c mm	25	32-50
 Clamping screw for insert Tightening torque	FS2080 (Torx 15 IP) 3,5 Nm	FS1453 (Torx 15 IP) 3,5 Nm

Accessories

D _c mm	25-50
 Torque screwdriver	FS2003
 Interchangeable blade	FS2014 (Torx 15IP)
 Screwdriver	FS1485 (Torx 15IP)

Indexable inserts

	Radius mm	Face chamfer width mm	P			M			K			N		S			H	
			HC	HC	HC	HC	HC	HC	HC	HW	HC	HC	HC	HC				
			WKP25S	WKP35S	WSP45	WSM35	WSM35S	WSP45	WAK15	WKK25	WKP25S	WKP35S	WXN15	WK10	WSM35	WSM35S	WSP45	WHH15
 ADGT160616R-D67	1,6	1			☒	☒	☒	☒							☒	☒	☒	
ADGT160630R-D67	3	0,8			☒	☒	☒	☒							☒	☒	☒	
ADGT1606PER-D51	0,8	1,6		☒	☒			☒									☒	
ADGT1606PER-D56	0,8	1,6		☒	☒	☒	☒	☒		☒	☒				☒	☒	☒	
ADGT1606PER-D67	0,8	1,6		☒	☒	☒	☒	☒		☒	☒				☒	☒	☒	
ADGT1606PER-F56	0,8	1,6		☒	☒		☒	☒									☒	
ADGT1606PER-G77	0,8	1,2		☒	☒	☒	☒	☒							☒	☒	☒	
ADHT160616R-G88	1,6	1,4											☒	☒				
ADHT160625R-G88	2,5	1,2											☒	☒				
ADHT160630R-G88	3	1,2											☒	☒				
ADHT160640R-G88	4	1											☒	☒				
ADHT1606PER-G88	0,8	1,6											☒	☒				
ADKT1606PER-F56	0,8	1,6	☒		☒			☒			☒	☒					☒	
ADMT160608R-D56	0,8	1,6	☒	☒				☒		☒	☒	☒						
ADMT160608R-F56	0,8	1,6	☒		☒	☒	☒	☒	☒	☒	☒	☒			☒	☒	☒	
ADMT160608R-G56	0,8	1,6		☒	☒	☒	☒	☒				☒			☒	☒	☒	
ADMT160612R-F56	1,2	1,6		☒		☒	☒	☒				☒			☒	☒	☒	
ADMT160616R-F56	1,6	1,4		☒	☒	☒	☒	☒				☒			☒	☒	☒	
ADMT160620R-F56	2	1,4		☒	☒		☒	☒				☒				☒	☒	
ADMT160625R-F56	2,5	1,2		☒	☒	☒	☒	☒				☒			☒	☒	☒	
ADMT160630R-F56	3	1,2		☒	☒	☒	☒	☒				☒			☒	☒	☒	
ADMT160632R-F56	3,2	1,2		☒		☒	☒	☒				☒			☒	☒	☒	
ADMT160640R-F56	4	1		☒	☒	☒	☒	☒				☒			☒	☒	☒	
ADMT160650R-F56	5			☒	☒	☒	☒	☒				☒			☒	☒	☒	
ADMT160660R-F56	6			☒	☒	☒	☒	☒				☒			☒	☒	☒	

If the corner radius is R = 2.0 mm or above, the body in the corner area must be reworked.

$$R_{(body)} = R_{(insert)} - 1 \text{ mm}$$

HC = Coated carbide

HW = Uncoated carbide

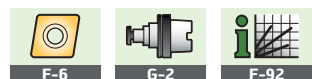
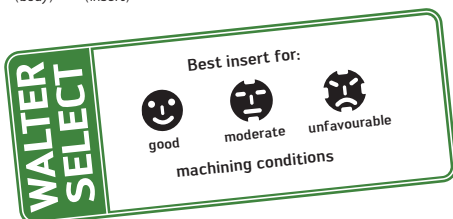

Shoulder milling cutter F 4042

AD . . 1606 . .

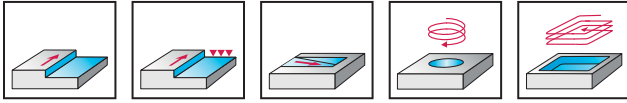
Xtra-tec®

- Approach angle $\kappa = 90^\circ$
- Two cutting edges per indexable insert
- Positive basic insert shape

Tool	Designation	D _c mm	d ₁ mm	l ₄ mm	L _c mm	Z	kg	No. of indexable inserts	Type
Cyl. bore DIN 138 longitudinal key way 	F4042.B16.040.Z03.15	40	16	40	15	3	0,2	3	AD . . 1606 . .
	F4042.B16.040.Z04.15*	40	16	40	15	4	0,19	4	
	★ F4042.B16.044.Z03.15	44	16	40	15	3	0,24	3	
	F4042.B22.050.Z03.15*	50	22	40	15	3	0,3	3	
	F4042.B22.050.Z05.15	50	22	40	15	5	0,31	5	
	★ F4042.B22.054.Z03.15	54	22	40	15	3	0,36	3	
	F4042.B22.063.Z04.15*	63	22	40	15	4	0,6	4	
	F4042.B22.063.Z06.15	63	22	40	15	6	0,6	6	
	F4042.B27.063.Z04.15*	63	27	50	15	4	0,6	4	
	F4042.B27.063.Z06.15	63	27	50	15	6	0,38	6	
	★ F4042.B27.066.Z04.15	66	27	50	15	4	0,8	4	
	F4042.B27.080.Z04.15	80	27	50	15	4	1,1	4	
	F4042.B27.080.Z05.15*	80	27	50	15	5	1	5	
	F4042.B27.080.Z07.15	80	27	50	15	7	1,1	7	
	★ F4042.B27.084.Z05.15	84	27	50	15	5	1,1	5	
	F4042.B32.100.Z04.15	100	32	50	15	4	1,7	4	
	F4042.B32.100.Z05.15*	100	32	50	15	5	1,6	5	
	F4042.B32.100.Z08.15	100	32	50	15	8	1,8	8	
	F4042.B40.125.Z05.15	125	40	63	15	5	3,3	5	
	F4042.B40.125.Z07.15*	125	40	63	15	7	3,2	7	
F4042.B40.125.Z10.15	125	40	63	15	10	3,5	10		
Cyl. bore DIN 138 longitudinal key way 	F4042.B40.160.Z06.15	160	40/40 B	63	15	6	4,2	6	AD . . 1606 . .
	F4042.B40.160.Z08.15*	160	40/40 B	63	15	8	4,2	8	
	F4042.B40.160.Z12.15	160	40/40 B	63	15	12	4,4	12	

Bodies and assembly parts are included in the scope of delivery.

* Balanced construction to G 6.3 at 10,000 rpm.

★ New addition to range

Assembly parts

	D _c mm	40-160
	Clamping screw for insert Tightening torque	FS1453 (Torx 15 IP) 3,5 Nm

Accessories

	D _c mm	40-125	160
	Sealing disc incl. gasket + screws		FS936 COMPLETE SET
	Torque screwdriver	FS2003	FS2003
	Interchangeable blade	FS2014 (Torx 15IP)	FS2014 (Torx 15IP)
	Screwdriver	FS1485 (Torx 15IP)	FS1485 (Torx 15IP)
	Gasket		O-R 96X4

Indexable inserts

	Radius mm	Face chamfer width mm	P			M			K			N		S			H
			HC			HC			HC			HC	HW	HC			HC
			WKP25S	WKP35S	WSP45	WSM35	WSM35S	WSP45	WAK15	WKK25	WKP25S	WKP35S	WXN15	WK10	WSM35	WSM35S	WSP45
	ADGT160616R-D67	1,6	1			☺	☺										
	ADGT160630R-D67	3	0,8			☺	☺										
	ADGT1606PER-D51	0,8	1,6		☺	☺											
	ADGT1606PER-D56	0,8	1,6		☺	☺			☺								
	ADGT1606PER-D67	0,8	1,6			☺	☺	☺									
	ADGT1606PER-F56	0,8	1,6			☺											
	ADGT1606PER-G77	0,8	1,2			☺	☺										
	ADHT160616R-G88	1,6	1,4									☺	☺				
	ADHT160625R-G88	2,5	1,2									☺	☺				
	ADHT160630R-G88	3	1,2									☺	☺				
	ADHT160640R-G88	4	1									☺	☺				
	ADHT1606PER-G88	0,8	1,6									☺	☺				
	ADKT1606PER-F56	0,8	1,6	☹	☹					☹							☺
	ADMT160608R-D56	0,8	1,6	☹	☹					☹	☹						
	ADMT160608R-F56	0,8	1,6	☹		☺	☺			☹							☺
	ADMT160608R-G56	0,8	1,6		☺	☺	☺	☺									☺
	ADMT160612R-F56	1,2	1,6		☺												
	ADMT160616R-F56	1,6	1,4		☺	☺											☺
	ADMT160620R-F56	2	1,4		☺	☺											☺
	ADMT160625R-F56	2,5	1,2		☺	☺											☺
	ADMT160630R-F56	3	1,2		☺	☺											☺
	ADMT160632R-F56	3,2	1,2		☺												☺
	ADMT160640R-F56	4	1		☺	☺											☺
	ADMT160650R-F56	5			☺	☺											☺
	ADMT160660R-F56	6			☺	☺											☺

If the corner radius is R = 2.0 mm or above, the body in the corner area must be reworked.

$$R_{(body)} = R_{(insert)} - 1 \text{ mm}$$

HC = Coated carbide

HW = Uncoated carbide

WALTER SELECT

Best insert for:

☺
good

☹
moderate

☹
unfavourable

machining conditions



Shoulder milling cutter F 5041 LNHU 0904 . .

Walter BLAXX

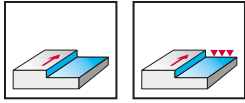

- Approach angle $\kappa = 90^\circ$
- Four cutting edges per indexable insert
- Negative basic insert shapes
- Tangential indexable insert arrangement

Tool	Designation	D _c mm	d ₁ mm	l ₄ mm	L _c mm	l ₁ mm	Z	kg	No. of indexable inserts	Type
NCT ScrewFit 	★ F5041.T22.025.Z03.08*	25	T22	35	8		3	0,11	3	LN . . 0904 . .
	★ F5041.T22.025.Z04.08	25	T22	35	8		4	0,11	4	
	★ F5041.T28.032.Z04.08*	32	T28	40	8		4	0,21	4	
	★ F5041.T28.032.Z05.08	32	T28	40	8		5	0,21	5	
Shank DIN 1835-B 	★ F5041.W25.025.Z03.08*	25	25	43	8	100	3	0,33	3	LN . . 0904 . .
	★ F5041.W25.025.Z04.08	25	25	43	8	100	4	0,32	4	
	★ F5041.W32.032.Z04.08*	32	32	49	8	110	4	0,6	4	
	★ F5041.W32.032.Z05.08	32	32	49	8	110	5	0,6	5	
	★ F5041.W32.040.Z04.08*	40	32	49	8	110	4	0,7	4	
	★ F5041.W32.040.Z06.08	40	32	49	8	110	6	0,7	6	
Parallel shank without flat 	★ F5041.Z25.025.Z03.08*	25	25	38	8	200	3	0,7	3	LN . . 0904 . .
	★ F5041.Z25.025.Z04.08	25	25	38	8	200	4	0,7	4	
	★ F5041.Z32.032.Z04.08*	32	32	39	8	250	4	1,5	4	
	★ F5041.Z32.032.Z05.08	32	32	39	8	250	5	1,5	5	
Cyl. bore DIN 138 longitudinal key way 	★ F5041.B16.040.Z04.08*	40	16	40	8		4	0,2	4	LN . . 0904 . .
	★ F5041.B16.040.Z06.08	40	16	40	8		6	0,25	6	
	★ F5041.B22.050.Z05.08*	50	22	40	8		5	0,36	5	
	★ F5041.B22.050.Z07.08	50	22	40	8		7	0,37	7	
	★ F5041.B22.063.Z07.08*	63	22	40	8		7	0,6	7	
	★ F5041.B22.063.Z10.08	63	22	40	8		10	0,6	10	

Bodies and assembly parts are included in the scope of delivery.

For flat wrenches for screw heads, see page G 105 of the Walter General catalogue 2012.

* Balanced construction to G 6.3 at 10,000 rpm.

★ New addition to range

Assembly parts

	D _c mm	25-63
	Clamping screw	FS1457 (Torx 9 IP)
	Tightening torque	2,0 Nm

Accessories

	D _c mm	25-63
	Torque screwdriver	FS2003
	Screwdriver	FS1484 (Torx 9IP)
	Interchangeable blade	FS2013 (Torx 9IP)

Indexable inserts

	Radius mm	Face chamfer width mm	P			M		K				N		S		H
			HC			HC		HC				HC	HW	HC		HC
			WKP25S	WKP35S	WSP45S	WSM35S	WSP45S	WAK15	WKK25	WKP25S	WKP35S	WXN15	WK10	WSM35S	WSP45S	WHH15
	LNHU090404R-L55T	0,4	1,5	☺	☺	☺	☺	☺	☺	☺	☺	☺	☺	☺	☺	
	LNHU090404R-L85T	0,4	1,5								☺	☺				
	LNHU090408R-L55T	0,8	1,1		☺	☺	☺	☺						☺	☺	
	LNHU090412R-L55T	1,2	0,8		☺	☺	☺	☺						☺	☺	
	LNHU090416R-L55T	1,6			☺	☺	☺	☺						☺	☺	
	LNHU090420R-L55T	2			☺	☺	☺	☺						☺	☺	

HC = Coated carbide
HW = Uncoated carbide

WALTER SELECT

Best insert for:

☺
good

☹
moderate

☹
unfavourable

machining conditions

Shoulder milling cutter F 5141 LNHU 1306 . .

Walter BLAXX

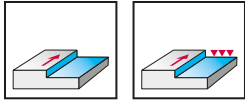

- Approach angle $\kappa = 90^\circ$
- Four cutting edges per indexable insert
- Negative basic insert shapes
- Tangential indexable insert arrangement

Tool	Designation	D_c mm	d_1 mm	l_4 mm	L_c mm	l_1 mm	Z	kg	No. of indexable inserts	Type
NCT ScrewFit	★ F5141.T36.040.Z05.12	40	T36	40	12		5	0,35	5	LN...1306..
	★ F5141.T45.050.Z06.12	50	T45	40	12		6	0,5	6	
Shank DIN 1835-B	★ F5141.W32.040.Z03.12*	40	32	49	12	110	3	0,7	3	LN...1306..
	★ F5141.W32.040.Z05.12	40	32	49	12	110	5	0,7	5	
Parallel shank without flat	★ F5141.Z32.040.Z03.12*	40	32	44	12	250	3	1,5	3	LN...1306..
	★ F5141.Z32.040.Z05.12	40	32	44	12	250	5	1,5	5	
Cyl. bore DIN 138 longitudinal key way	★ F5141.B16.040.Z04.12*	40	16	40	12		4	0,2	4	LN...1306..
	★ F5141.B16.040.Z05.12	40	16	40	12		5	0,2	5	
	★ F5141.B22.050.Z05.12*	50	22	40	12		5	0,32	5	
	★ F5141.B22.050.Z06.12	50	22	40	12		6	0,5	6	
	★ F5141.B22.063.Z06.12*	63	22	40	12		6	0,6	6	
	★ F5141.B22.063.Z08.12	63	22	40	12		8	0,6	8	
	★ F5141.B27.080.Z07.12*	80	27	50	12		7	1,3	7	
	★ F5141.B27.080.Z10.12	80	27	50	12		10	1,1	10	
	★ F5141.B32.100.Z09.12*	100	32	50	12		9	2,7	9	
	★ F5141.B32.100.Z13.12	100	32	50	12		13	2,7	13	
	★ F5141.B40.125.Z11.12*	125	40	63	12		11	3,8	11	
★ F5141.B40.125.Z16.12	125	40	63	12		16	4,7	16		

Bodies and assembly parts are included in the scope of delivery.

For flat wrenches for screw heads, see page G 105 of the Walter General catalogue 2012.

* Balanced construction to G 6.3 at 10,000 rpm.

★ New addition to range

Assembly parts

	D _c mm	40-125
	Clamping screw Tightening torque	FS2081 (Torx 15 IP) 3,0 Nm

Accessories

	D _c mm	40-125
	Torque screwdriver	FS2003
	Screwdriver	FS1485 (Torx 15IP)
	Interchangeable blade	FS2014 (Torx 15IP)

Indexable inserts

	Radius mm	Face chamfer width mm	P		M		K				N		S		H
			HC		HC		HC				HC	HW	HC	HC	HC
			WKP25S	WKP35S	WSP45S	WSM35S	WSP45S	WAK15	WKK25	WKP25S	WKP35S	WXN15	WK10	WSM35S	WSP45S
	LNHU130608R-L55T	0,8	2,2	☺	☺	☺	☺	☺	☺	☺					
	LNHU130608R-L85T	0,8	2,2								☺	☺			
	LNHU130612R-L55T	1,2	1,85		☺	☺	☺	☺					☺	☺	
	LNHU130616R-L55T	1,6	1,5		☺	☺	☺	☺					☺	☺	
	LNHU130620R-L55T	2	1,15		☺	☺	☺	☺					☺	☺	
	LNHU130625R-L55T	2,5	0,7		☺	☺	☺	☺					☺	☺	
	LNHU130630R-L55T	3			☺	☺	☺	☺					☺	☺	
	LNHU130632R-L55T	3,2			☺	☺	☺	☺					☺	☺	

HC = Coated carbide
HW = Uncoated carbide

WALTER SELECT

Best insert for:

☺
good

☹
moderate

☹
unfavourable

machining conditions

Shoulder milling cutter F 5241 LNHU 1607 . .

Walter BLAXX

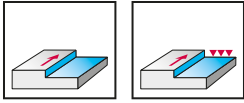

- Approach angle $\kappa = 90^\circ$
- Four cutting edges per indexable insert
- Negative basic insert shapes
- Tangential indexable insert arrangement

Tool	Designation	D _c mm	d ₁ mm	l ₄ mm	L _c mm	Z	kg	No. of indexable inserts	Type
Cyl. bore DIN 138 longitudinal key way 	★ F5241.B22.050.Z03.15*	50	22	40	15	3	0,3	3	LN . . 1607 . .
	★ F5241.B22.050.Z05.15	50	22	40	15	5	0,31	5	
	★ F5241.B22.063.Z04.15*	63	22	40	15	4	0,5	4	
	★ F5241.B22.063.Z06.15	63	22	40	15	6	0,6	6	
	★ F5241.B27.080.Z05.15*	80	27	50	15	5	1	5	
	★ F5241.B27.080.Z07.15	80	27	50	15	7	1,1	7	
	★ F5241.B32.100.Z06.15*	100	32	50	15	6	1,7	6	
	★ F5241.B32.100.Z08.15	100	32	50	15	8	1,8	8	
	★ F5241.B40.125.Z07.15*	125	40	63	15	7	3,2	7	
	★ F5241.B40.125.Z10.15	125	40	63	15	10	3,3	10	
	★ F5241.B40.160.Z08.15*	160	40	63	15	8	4,4	8	
	★ F5241.B40.160.Z12.15	160	40	63	15	12	4,5	12	





Bodies and assembly parts are included in the scope of delivery.

* Balanced construction to G 6.3 at 10,000 rpm.

Assembly parts

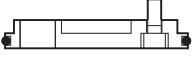
D _c mm	50	63-160	
	Clamping screw for insert Tightening torque	FS1495 (Torx 20 IP) 5,0 Nm	FS2112 (Torx 20 IP) 5,0 Nm

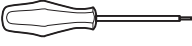
Accessories

D _c mm	50-125	160
	Sealing disc set, complete	FS936 COMPLETE SET
	Torque screwdriver	FS2003
	Screwdriver	FS1486 (Torx 20IP)
	Interchangeable blade	FS2015 (Torx 20IP)
	Gasket	O-R 96X4

Indexable inserts

	Radius mm	Face chamfer width mm	P		M			K			N		S		H
			HC		HC			HC			HC	HW	HC		HC
			WKP25S	WKP35S	WSP45S	WSM35S	WSP45S	WAK15	WKK25	WKP25S	WKP35S	WXN15	WK10	WSM35S	WSP45S
	LNHU160708R-L55T	0,8	2,3	☹	☹	☹	☹	☹	☹	☹	☹	☹	☹	☹	
	LNHU160708R-L85T	0,8	2,3							☹	☹				
	LNHU160712R-L55T	1,2	1,9		☹	☹	☹	☹				☹	☹		
	LNHU160716R-L55T	1,6	1,6		☹	☹	☹	☹				☹	☹		
	LNHU160720R-L55T	2	1,2		☹	☹	☹	☹				☹	☹		
	LNHU160725R-L55T	2,5			☹	☹	☹	☹				☹	☹		

HC = Coated carbide
HW = Uncoated carbide

WALTER SELECT

Best insert for:

 good



 moderate

 unfavourable

machining conditions

F 5138 porcupine cutter LNHU 1306 . .

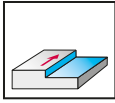
Walter BLAXX



- Approach angle $\kappa = 90^\circ$
- Four cutting edges per indexable insert
- Negative basic insert shapes
- Tangential indexable insert arrangement
- Full effective teeth version

Tool	Designation	D_c mm	d_1 mm	l_4 mm	l_1 mm	L_c mm	Z	kg	No. of indexable inserts	Type
NCT ScrewFit 	★ F5138.T36.040.Z02.23	40	T36	45		23	2	0,36	2 2	LN . . 1306 . .
	★ F5138.T36.040.Z02.34	40	T36	55		34	2	0,39	2 4	
Shank DIN 1835-B 	★ F5138.W40.040.Z02.34	40	40	54	120	34	2	1	2 4	LN . . 1306 . .
	★ F5138.W40.040.Z02.45	40	40	64	135	45	2	1,1	2 6	
Cyl. bore DIN 138 longitudinal key way 	★ F5138.B16.040.Z02.34	40	16	55		34	2	0,3	2 4	LN . . 1306 . .
	★ F5138.B16.040.Z02.45	40	16	65		45	2	0,33	2 6	
	★ F5138.B22.050.Z03.34	50	22	55		34	3	0,46	3 6	
	★ F5138.B22.050.Z03.45	50	22	65		45	3	0,5	3 9	
	★ F5138.B27.063.Z04.45	63	27	70		45	4	1,1	4 12	
	★ F5138.B27.063.Z04.56	63	27	80		56	4	1,2	4 16	
	★ F5138.B32.080.Z05.56	80	32	85		56	5	2,2	5 20	

Bodies and assembly parts are included in the scope of delivery.

For flat wrenches for screw heads, see page G 105 of the Walter General catalogue 2012.

For special clamping screws for arbour mounted tools, see page G-41.

Assembly parts

		D _c mm	40-80
	Clamping screw for insert Tightening torque		FS2081 (Torx 15 IP) 3,0 Nm

Accessories

		D _c mm	40-80
	Torque screwdriver		FS2003
	Screwdriver		FS1485 (Torx 15IP)
	Interchangeable blade		FS2014 (Torx 15IP)
	Coolant nozzle*		FS2250

* FS2250 coolant nozzle must be secured against loosening.

Indexable inserts

	Radius mm	Face chamfer width mm	P		M		K			N		S		H
			HC		HC		HC			HC	HW	HC		HC
			WKP25S	WKP35S	WSP45S	WSM35S	WSP45	WAK15	WKK25	WKP25S	WKP35S	WXN15	WK10	WSM35S
	LNHU130608R-L55T	0,8	2,2	☺	☹	☹	☹	☹	☹	☹	☹	☹	☹	
	LNHU130608R-L85T	0,8	2,2							☺	☹			
	LNHU130612R-L55T	1,2	1,85		☹	☹	☹	☹				☹	☹	
	LNHU130616R-L55T	1,6	1,5		☹	☹	☹	☹				☹	☹	
	LNHU130620R-L55T	2	1,15		☹	☹	☹	☹				☹	☹	
	LNHU130625R-L55T	2,5	0,7		☹	☹	☹	☹				☹	☹	
	LNHU130630R-L55T	3			☹	☹	☹	☹				☹	☹	
	LNHU130632R-L55T	3,2			☹	☹	☹	☹				☹	☹	

Indexable inserts with corner radius R > 0.8 mm can only be used as front inserts.

HC = Coated carbide
HW = Uncoated carbide

WALTER SELECT

Best insert for:

☺
good

☹
moderate

☹
unfavourable

machining conditions

Walter Select – Slot milling

Machining		
Lead angle K	90°	
Slot mill	<p>F 2237</p>	
Ø range [mm]	18–40	
Page	<i>F 174*</i>	
P Steel	••	
M Stainless steel	••	
K Cast iron	••	
N NF metals	•	
S Difficult-to-machine materials	•	
H Hard materials		
O Other		
Basic insert shape		
Insert types	LP .. 07 .. / SP .. 06 .. LP .. 15 .. / SP .. 09 .. SP .. 12 ..	
Max. cutting depths [mm]	25	
Number of cutting edges per indexable insert	2 / 4	

* The pages indicated in italics refer to the Walter General catalogue 2012.

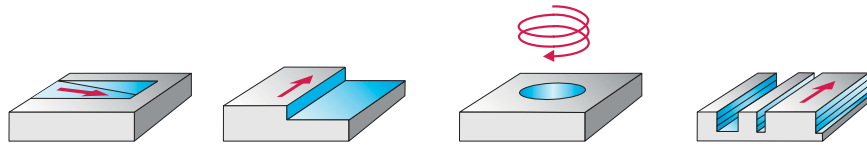

	90°	90°	90°
	F 2238CE / CK	F 2238	F 2338
	50-80	20-125	63-100
	F 178*	F 176*	F 184*
	••	••	••
	••	••	••
	••	••	••
	•	•	•
	••	••	••
	LP .. 1504 .. SP .. 1204 ..	LP .. 0703 .. / LP .. 1504 .. LP .. 15T3 .. SP .. 0603 .. / SP .. 09T3 .. SP .. 1204 ..	LP .. 1506 .. SP .. 1206 ..
	117	87	103
	2 / 4	2 / 4	2 / 4



Walter Select – Slot milling

Machining				
Lead angle k	90°		90°	
Slot mill	F 2252 		F 5055 Walter BLAXX	
Ø range [mm]	100–315	80–315	63–250	
Page	<i>F 186 / F 190*</i>	<i>F 188 / F 194*</i>	F-84	
P Steel	••	••	••	
M Stainless steel	••	••	•	
K Cast iron	••	••	••	
N NF metals	••	••	••	
S Difficult-to-machine materials	••	•	•	
H Hard materials		•		
O Other	•	•	•	
Basic insert shape				
Insert types	AD .. 0803 .. AD .. 1204 .. AD .. 1606 ..	MP .. 0603 .. MP .. 0803 .. MP .. 1204 ..	SX ..	
Helically toothed: max. cutting depths [mm]	8 + 11,7 + 15	6 + 8 + 12	—	
Cross-toothed Max. cutting widths [mm]	12–25	8–23,5	2,0 + 3,0 + 4,0	
Number of cutting edges per indexable insert	2	2	1	

* The pages indicated in italics refer to the Walter General catalogue 2012.

	90°	90°	90°
	F 4053	F 4153	F 4253
	Xtra-tec®	Xtra-tec®	Xtra-tec®
	80-160	80-200	100-315
	<i>F 200*</i>	<i>F 204*</i>	<i>F 208*</i>
	••	••	••
	••	••	••
	••	••	••
	•	•	•
	••	••	••
	LN . X 070204 ..	LN .. 0803 .. LN .. 0804 .. LN .. 1005 ..	LN .. 0804 .. LN .. 1005 .. LN .. 1206 .. LN .. 1608 ..
	—	—	—
	4	6 + 8 + 10	12 + 14 + 16 + 20 + 25
	2 + 2	2 + 2	2 + 2



Slitting cutter F 5055.B

Walter BLAXX

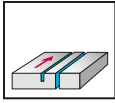





- Approach angle $\kappa = 90^\circ$
- One cutting edge per indexable insert
- Positive basic insert shape

Tool	Designation	D _c mm	d ₁ mm	SB mm	a _{e max} mm	l ₁₀ mm	Z	kg	No. of indexable inserts	
									Type	Type
Cyl. bore DIN 138 longitudinal key way 	★ F5055.B16.063.Z05.2.0	63	16	2	15	1,6	5	0,023	5	SX-2
	★ F5055.B16.063.Z04.3.0	63	16	3	15	2,4	4	0,034	4	SX-3
	★ F5055.B16.063.Z04.4.0	63	16	4	15	3,4	4	0,048	4	SX-4
	★ F5055.B16.080.Z07.2.0	80	16	2	20	1,6	7	0,041	7	SX-2
	★ F5055.B16.080.Z06.3.0	80	16	3	20	2,4	6	0,061	6	SX-3
	★ F5055.B16.080.Z06.4.0	80	16	4	20	3,4	6	0,086	6	SX-4
	★ F5055.B22.100.Z09.2.0	100	22	2	25	1,6	9	0,068	9	SX-2
	★ F5055.B22.100.Z09.3.0	100	22	3	25	2,4	9	0,1	9	SX-3
	★ F5055.B22.100.Z09.4.0	100	22	4	25	3,4	9	0,14	9	SX-4
	★ F5055.B32.125.Z11.2.0	125	32	2	33	1,6	11	0,11	11	SX-2
	★ F5055.B32.125.Z11.3.0	125	32	3	33	2,4	11	0,17	11	SX-3
	★ F5055.B32.125.Z11.4.0	125	32	4	33	3,4	11	0,24	11	SX-4
	★ F5055.B40.160.Z14.2.0	160	40	2	38	1,6	14	0,19	14	SX-2
	★ F5055.B40.160.Z14.3.0	160	40	3	38	2,4	14	0,29	14	SX-3
	★ F5055.B40.160.Z14.4.0	160	40	4	38	3,4	14	0,4	14	SX-4
	★ F5055.B40.200.Z19.3.0	200	40	3	58	2,4	19	0,48	19	SX-3
	★ F5055.B40.200.Z19.4.0	200	40	4	58	3,4	19	0,7	19	SX-4
	★ F5055.B40.250.Z24.3.0	250	40	3	83	2,4	24	0,8	24	SX-3
	★ F5055.B40.250.Z24.4.0	250	40	4	83	3,4	24	1,1	24	SX-4

Values for a_{e max} in combination with drive collar.

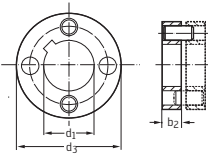
For information on high-speed applications, see page F-122.

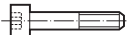
To fit the indexable insert, use the mounting wrench FS 1494.

Accessories	D _c mm SBmm	63 2	63 3-4	80 2-4	100 2-4	125 2-4	160 2-4	200 3-4	250 3-4
 Drive collar		FS1345	FS1346	FS1347	FS1348	FS1349	FS1350	FS1350	FS1350
 Mounting wrench		FS1494	FS1494	FS1494	FS1494	FS1494	FS1494	FS1494	FS1494
 Clamping screw for retaining washer								FS966 (SW 5)	FS966 (SW 5)
Retaining washer instead of drive collar								FS1351	FS1351
 Allen key for clamping screw								ISO 2936-5 (SW 5)	ISO 2936-5 (SW 5)
Retaining washer instead of drive collar									FS1352

Drive collars and retaining discs should always be ordered in pairs.
Clamping screws for retaining washers are included in the scope of delivery.

Indexable inserts

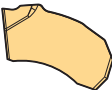
	s mm	r mm	P			M			K		N		S			H	
			HC			HC			HC		HC	HW	HC			HC	HC
			WSM23S	WSM33S	WSM43S	WSM23S	WSM33S	WSM43S	WKP25S	WKP35S	WXN15	WK10	WSM23S	WSM33S	WSM43S	WHH15	WXM15
 SX-2E200N02-CE4	2	0,2	☒	☒	☒	☒	☒	☒					☒	☒			
SX-3E300N02-CE4	3	0,2	☒	☒	☒	☒	☒						☒	☒			
SX-4E400N02-CE4	4	0,2	☒	☒	☒	☒	☒						☒	☒			
SX-2E200N02-CF5	2	0,2	☒	☒	☒	☒	☒						☒	☒			
SX-3E300N02-CF5	3	0,2	☒	☒	☒	☒	☒						☒	☒			
SX-4E400N02-CF5	4	0,2	☒	☒	☒	☒	☒						☒	☒			
SX-2E200N02-CF6	2	0,2	☒	☒	☒	☒	☒						☒	☒			
SX-3E300N02-CF6	3	0,2	☒	☒	☒	☒	☒						☒	☒			

HC = Coated carbide
HW = Uncoated carbide

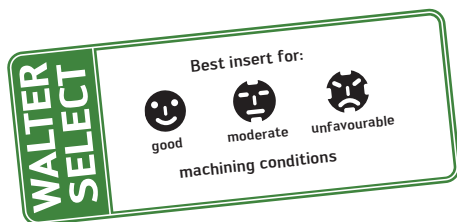

Walter Select – Copy milling

Machining					
Copy milling cutter	F 2139	F 2239 B	F 2231 / A	F 4031 NEW Xtra-tec®	F 2339 / A + B
Ø range [mm]	8–32	20–50	10–40	8–32	16–50
Page	<i>F 214*</i>	<i>F 226*</i>	<i>F 216*</i>	F-90	<i>F 228*</i>
P Steel	••	••	••	••	••
M Stainless steel	••	•	••	••	••
K Cast iron	••	••	••	••	••
N NF metals	••	•	••	•	•
S Difficult-to-machine materials	••	•	•	••	•
H Hard materials	••		••	••	•
O Other	•	•	•		
Basic insert shape					
Insert types	P 3201 P 3204	P 2631 ...	RD .. 0501 / 0803 .. RD .. 10T3 / 1204 .. RD .. 1505 / 1605 .. RD .. 2006 ..	P 8001	XD .. 13 / 16 / 20 / 24 .. XD .. 25 / 32 / 40 .. SP .. 0603/09T3 .. SP .. 1204 ..
Max. cutting depths [mm]	4–16	15–39	2,5–10	2,0–3,5	11–57
Number of cutting edges per indexable insert	1	3	–	1	2 / 4

* The pages indicated in italics refer to the Walter General catalogue 2012.

<p style="text-align: center;">F 2239</p>	<p style="text-align: center;">F 2234</p>	<p style="text-align: center;">F 2334</p>	<p style="text-align: center;">F 2334R</p>
<p style="text-align: center;">20-63</p>	<p style="text-align: center;">12-160</p>	<p style="text-align: center;">25-160</p>	<p style="text-align: center;">25-63</p>
<p style="text-align: center;"><i>F 226*</i></p>	<p style="text-align: center;"><i>F 218*</i></p>	<p style="text-align: center;"><i>F 222*</i></p>	<p style="text-align: center;">F-88</p>
<p style="text-align: center;">••</p>	<p style="text-align: center;">••</p>	<p style="text-align: center;">••</p>	<p style="text-align: center;">••</p>
<p style="text-align: center;">•</p>	<p style="text-align: center;">••</p>	<p style="text-align: center;">••</p>	<p style="text-align: center;">••</p>
<p style="text-align: center;">••</p>	<p style="text-align: center;">••</p>	<p style="text-align: center;">••</p>	<p style="text-align: center;">••</p>
<p style="text-align: center;">•</p>	<p style="text-align: center;">••</p>	<p style="text-align: center;">•</p>	<p style="text-align: center;">•</p>
<p style="text-align: center;">•</p>	<p style="text-align: center;">•</p>	<p style="text-align: center;">••</p>	<p style="text-align: center;">••</p>
<p style="text-align: center;">••</p>	<p style="text-align: center;">••</p>	<p style="text-align: center;">•</p>	<p style="text-align: center;">•</p>
<p style="text-align: center;">•</p>	<p style="text-align: center;">•</p>	<p style="text-align: center;">•</p>	<p style="text-align: center;">•</p>
<p>P 2631 .. SP .. 0603 .. SP .. 09T3 .. SP .. 1204 ..</p>	<p style="text-align: center;">RD ..</p>	<p style="text-align: center;">RO . X ..</p>	<p style="text-align: center;">RO . X ..</p>
<p style="text-align: center;">15-84</p>	<p style="text-align: center;">2,5-10</p>	<p style="text-align: center;">4-10</p>	<p style="text-align: center;">5 + 6</p>
<p style="text-align: center;">3 / 4</p>	<p style="text-align: center;">-</p>	<p style="text-align: center;">4 / 6 / 8</p>	<p style="text-align: center;">4</p>



Round insert cutter F 2334R

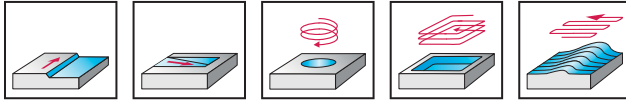

- Four cutting edges per indexable insert
- Positive basic insert shape
- With indexing faces
- Reinforced design

Tool	Designation	R mm	D _a mm	d ₁ mm	l ₄ mm	l ₁ mm	L _c mm	Z	kg	No. of indexable inserts	Type
NCT ScrewFit 	★ F2334R.T22.025.Z03.05	5	25	T22	35		5	3	0,1	3	RO . X 10T3 . .
	★ F2334R.T28.032.Z04.05	5	32	T28	40		5	4	0,2	4	RO . X 10T3 . .
	★ F2334R.T36.040.Z04.06	6	40	T36	40		6	4	0,31	4	RO . X 1204 . .
Parallel shank 	★ F2334R.Z32.032.Z04.05	5	32	32	70	131	5	4	0,7	4	RO . X 10T3 . .
Cyl. bore DIN 138 longitudinal key way 	★ F2334R.B16.040.Z04.06	6	40	16	40		6	4	0,19	4	RO . X 1204 . .
	★ F2334R.B16.040.Z05.05	5	40	16	40		5	5	0,2	5	RO . X 10T3 . .
	★ F2334R.B16.040.Z05.06	6	40	16	40		6	5	0,21	5	RO . X 1204 . .
	★ F2334R.B16.040.Z06.05	5	40	16	40		5	6	0,21	6	RO . X 10T3 . .
	★ F2334R.B22.050.Z05.06	6	50	22	40		6	5	0,32	5	RO . X 1204 . .
	★ F2334R.B22.050.Z06.06	6	50	22	40		6	6	0,31	6	
	★ F2334R.B22.052.Z05.06	6	52	22	40		6	5	0,33	5	
	★ F2334R.B22.052.Z06.06	6	52	22	40		6	5	0,33	5	
	★ F2334R.B22.063.Z07.06	6	63	22	40		6	7	0,6	7	

Bodies and assembly parts are included in the scope of delivery.

For flat wrenches for screw heads, see page G 105 of the Walter General catalogue 2012.

★ New addition to range

Assembly parts		RO . X 10T3 . . 25	RO . X 10T3 . . 31,75–32	RO . X 1204 . . 38,1–63,5
	Type	FS2181 (Torx 15 IP)	FS2119 (Torx 15 IP)	FS1453 (Torx 15 IP)
	Tightening torque	3,0 Nm	3,0 Nm	3,5 Nm

Accessories		D _a mm Type
	Screwdriver	FS1485 (Torx 15IP)
	Torque screwdriver	FS2003
	Interchangeable blade	FS2014 (Torx 15IP)

Indexable inserts			P		M			K		N		S		H				
			HC		HC			HC		HC HW		HC		HC				
			WKP25S	WKP35S	WSP45	WSM35	WSM35S	WSP45	WAK15	WKK25	WKP25S	WKP35S	WXN15	WK10	WSM35	WSM35S	WSP45	WHH15
			Radius mm															
	ROGX10T3M0-G77	5																
	ROGX1204M0-G77	6																
	ROHX10T3M0-D57	5																
	ROHX10T3M0-D67	5																
	ROHX10T3M0-F67	5																
	ROHX10T3M0T-A27	5																
	ROHX1204M0-D57	6																
	ROHX1204M0-D67	6																
	ROHX1204M0-F67	6																
	ROHX1204M0T-A27	6																
	ROMX10T3M0-D57	5																
	ROMX1204M0-D57	6																

HC = Coated carbide
HW = Uncoated carbide

WALTER SELECT

Best insert for:

good

moderate

unfavourable

machining conditions

Profile mill F 4031

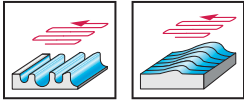
Xtra-tec®

- One cutting edge per exchangeable insert
- Positive basic insert shape

Tool	Designation	D _c mm	d ₁ mm	l ₄ mm	l ₁ mm	Z	kg	No. of indexable inserts	Type
NCT ScrewFit 	★ F4031.T14.012.Z02.20	12	T14	25		2	0,03	1	P8001-D12R..
	★ F4031.T14.016.Z02.25	16	T14	25		2	0,03	1	P8001-D16R..
	★ F4031.T18.020.Z02.32	20	T18	30		2	0,05	1	P8001-D20R..
	★ F4031.T22.025.Z02.40	25	T22	35		2	0,09	1	P8001-D25R..
	★ F4031.T28.032.Z02.50	32	T28	40		2	0,17	1	P8001-D32R..
Parallel shank without flat 	★ F4031.Z12.012.Z02.20	12	12	32	130	2	0,1	1	P8001-D12R..
	★ F4031.Z16.016.Z02.25	16	16	40	140	2	0,2	1	P8001-D16R..
	★ F4031.Z20.020.Z02.32	20	20	50	160	2	0,35	1	P8001-D20R..
	★ F4031.Z25.025.Z02.40	25	25	63	160	2	0,5	1	P8001-D25R..
	★ F4031.Z32.032.Z02.50	32	32	80	180	2	1	1	P8001-D32R..

Bodies and assembly parts are included in the scope of delivery.





For flat wrenches for screw heads, see page G 105 of the Walter General catalogue 2012.

★ New addition to range

Assembly parts

D _c mm	12	16	20	25	32
 Clamping screw for indexable insert Tightening torque	FS2072 (Torx 20 IP) 5,0 Nm	FS2073 (Torx 20 IP) 5,0 Nm	FS2074 (Torx 20 IP) 5,0 Nm	FS2075 (Torx 20 IP) 5,0 Nm	FS2107 (Torx 30 IP) 6,0 Nm

Accessories

D _c mm	12-25	32
 Torque screwdriver	FS2003	
 Interchangeable blade	FS2015 (Torx 20IP)	FS2109 (Torx 30IP)
 Screwdriver	FS1486 (Torx 20IP)	
 Torque T-handle	FS2041	

Indexable inserts

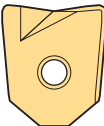
	Radius mm	Face chamfer width mm	P		M		K		N		S		H					
			HC		HC		HC		HC	HW	HC		HC					
			WKP25S	WKP35	WSP45	WSP46	WSM35	WSP45	WSP46	WAK15	WKK25	WKP25S	WKP35	WXN15	WK10	WSM35	WSP45	WSP46
 P8001-D12R05R-A57	0,5	1,5	☒	☒	☒	☒	☒			☒							☒	
P8001-D12R10R-A57	1	1,5	☒	☒	☒	☒	☒			☒							☒	☒
P8001-D16R10R-A57	1	1,5	☒	☒	☒	☒	☒			☒							☒	☒
P8001-D20R16R-A57	1,6	1,5	☒	☒	☒	☒	☒			☒							☒	☒
P8001-D25R20R-A57	2	1,5	☒	☒	☒	☒	☒			☒							☒	☒
P8001-D32R20R-A57	2	1,5	☒	☒	☒	☒	☒			☒							☒	☒

HC = Coated carbide
HW = Uncoated carbide

WALTER SELECT

Best insert for:



good



moderate



unfavourable

machining conditions

Cutting data for roughing

Face/shoulder milling

Material group	Structure of main material groups and code letters		Brinell hardness HB	Tensile strength R_m N/mm ²	Machining group ¹	= Cutting data for wet machining = Dry machining is possible		Cutting material grades								
								Starting values for cutting speed v_c [m/min]								
								HC								
								WKP35S		WKP25S		WAK15				
a_e / D_c^*		a_e / D_c^*		a_e / D_c^*		1/1 1/2		1/1 1/5		1/1 1/5						
P	Non-alloyed steel	C ≤ 0.25 %	annealed	125	428	P1	●	●●	250	300	290	320				
		C > 0.25... ≤ 0.55 %	annealed	190	639	P2	●	●●	220	260	260	330				
		C > 0.25... ≤ 0.55 %	tempered	210	708	P3	●	●●	215	250	255	320				
		C > 0.55 %	annealed	190	639	P4	●	●●	220	260	260	330				
		C > 0.55 %	tempered	300	1013	P5	●	●●	160	180	220	260				
		free cutting steel (short-chipping)	annealed	220	745	P6	●	●●	210	240	250	315				
	Low-alloyed steel	annealed	175	591	P7	●	●●	220	270	260	320					
		tempered	300	1013	P8	●	●●	170	190	210	250					
		tempered	380	1282	P9	●	●●	130	150	170	190					
		tempered	430	1477	P10	●	●●	110	130	150	170					
High-alloyed steel and high-alloyed tool steel	annealed	200	675	P11	●	●●	130	160	140	170						
	hardened and tempered	300	1013	P12	●	●●	80	90	110	130						
	hardened and tempered	400	1361	P13	●	●●	70	80	90	110						
Stainless steel	ferritic/martensitic, annealed	200	675	P14	●	●●	140	160								
	martensitic, tempered	330	1114	P15	●	●●	90	110								
M	Stainless steel	austenitic, quench hardened	200	675	M1	●●	●									
		austenitic, precipitation hardened (PH)	300	1013	M2	●●	●									
		austenitic/ferritic, duplex	230	778	M3	●●	●									
K	Malleable cast iron	ferritic	200	675	K1	●	●●	160	190	180	210	210	230			
		pearlitic	260	867	K2	●	●●	140	170	160	190	190	210			
	Grey cast iron	low tensile strength	180	602	K3	●	●●	300	330	320	350	380	410			
		high tensile strength/austenitic	245	825	K4	●	●●	190	220	180	210	230	260			
	Cast iron with spheroidal graphite	ferritic	155	518	K5	●	●●	200	220	220	240	260	280			
		pearlitic	265	885	K6	●	●●	130	150	140	170	170	200			
	GGV (CGI)		200	675	K7	●	●●	130	160	150	180	180	200			
N	Aluminium wrought alloys	cannot be hardened	30	–	N1	●●										
		hardenable, hardened	100	343	N2	●●										
	Cast aluminium alloys	≤ 12 % Si, cannot be hardened	75	260	N3	●●										
		≤ 12 % Si, hardenable, hardened	90	314	N4	●●										
		> 12 % Si, cannot be hardened	130	447	N5	●●										
	Magnesium alloys		70	250	N6	●●										
	Copper and copper alloys (bronze/brass)	non-alloyed, electrolytic copper	100	343	N7	●●										
		brass, bronze, red brass	90	314	N8	●●										
		Cu-alloys, short-chipping	110	382	N9	●●										
		high-strength, Ampco	300	1013	N10	●●										
S	Heat-resistant alloys	Fe-based	annealed	200	675	S1	●●									
			hardened	280	943	S2	●●									
		Ni or Co base	annealed	250	839	S3	●●									
			hardened	350	1177	S4	●●									
			cast	320	1076	S5	●●									
	Titanium alloys	pure titanium	200	675	S6	●●										
		α and β alloys, hardened	375	1262	S7	●●										
		β alloys	410	1396	S8	●●										
	Tungsten alloys		300	1013	S9	●●										
	Molybdenum alloys		300	1013	S10	●●										
H	Hardened steel	hardened and tempered	50 HRC	–	H1		●●					65	80			
		hardened and tempered	55 HRC	–	H2		●●					50	65			
		hardened and tempered	60 HRC	–	H3		●●					40	50			
	Hardened cast iron	hardened and tempered	55 HRC	–	H4		●●					50	65			
O	Thermoplastics	without abrasive fillers			O1	●●	●	400	400			400	400			
	Thermosetting plastics	without abrasive fillers			O2	●●	●	300	300			300	300			
	Plastic, glass-fibre reinforced	GFRP			O3											
	Plastic, carbon-fibre reinforced	CFRP			O4											
	Plastic, aramid-fibre reinforced	AFRP			O5											
	Graphite (technical)		80 Shore		O6		●●			400	500	600	800			

- Recommended application (the specified cutting data are regarded as starting values for the recommended application).
- Possible application, reduce cutting data by 30–50 % (increase for ISO M approx. 70–80 %).

¹ The classification of the machining groups can be found in the Walter General catalogue 2012 from page H 8 onwards.

² Cutting data can also be used without coolant.

* $a_e/D_c = 1/10$, $v_c = 10$ % higher than 1/5.

The specified cutting data are average recommended values.
For special applications, adjustment is recommended.

Cutting material grades																							
Starting values for cutting speed v_c [m/min]																							
HC																							
WSP45		WSP45S		WSM35		WSM35S		WKK25		WXN15		WFG40		WK10		WSN10		WCB50		WCB80		WCD10 ²	
a_e / D_c^*		a_e / D_c^*		a_e / D_c^*		a_e / D_c^*		a_e / D_c^*		a_e / D_c^*		a_e / D_c^*		a_e / D_c^*		a_e / D_c^*		a_e / D_c^*		a_e / D_c^*		a_e / D_c^*	
1/1	1/5	1/1	1/5	1/1	1/5	1/1	1/5	1/1	1/5	1/1	1/5	1/1	1/5	1/1	1/5	1/1	1/5	1/1	1/5	1/1	1/5	1/1	1/5
230	290	230	290																				
190	250	190	250																				
180	230	180	230																				
190	250	190	250																				
130	145	130	145																				
175	225	175	225																				
190	240	190	240																				
130	145	130	145																				
100	110	100	110																				
80	90	80	90																				
115	140	115	140																				
75	90	75	90																				
65	80	65	80																				
115	140	115	140	120	150	120	150																
80	100	80	100	80	110	80	110																
110	130	110	130	130	155	130	155																
90	100	90	100	100	120	100	120																
100	120	100	120	120	140	120	140																
								190	230							900	1000						
								170	200							800	900						
								350	380							1100	1300			1000	1250		
								190	230							900	1000			800	950		
								240	260							750	900			650	800		
								150	180							650	750			600	700		
								160	190							650	750			600	700		
										2640	2640	1500	1500	2200	2200								
										1980	1980	1000	1000	1650	1650								
										660	730			550	605								
										530	530			440	440								
										265	310			220	260								
										530	530			440	440								
										460	460			380	380								
										260	300			220	260								
										190	200			160	170								
										150	160			120	130								
65	70	65	70	80	90	80	90							75	80								
45	50	45	50	60	65	60	65							45	50								
50	55	50	55	60	70	60	70							55	60								
30	35	30	35	40	45	40	45							25	30								
40	45	40	45	50	55	50	55							35	40								
65	70	65	70	80	90	80	90							75	80								
30	35	30	35	40	45	40	45							25	30								
30	35	30	35	30	45	30	45							30	40								
70	80	70	80	70	80	70	80							70	80								
70	80	70	80	70	80	70	80							70	80								
								65	80							65	80			450	550		
								50	65							50	65			220	280		
								40	50							40	50			140	220		
								50	65							50	65			220	280		
400	400	400	400	400	400	400	400	400	400	400	400	400	400	400	400								
300	300	300	300	300	300	300	300	300	300	300	300	300	300	300	300								
								600	800	600	800					400	500						

HC = Coated carbide
HW = Uncoated carbide
HF = Uncoated fine-grained carbide

BH = CBN with high CBN content
BL = CBN with low CBN content
DP = Polycrystalline diamond
CN = Silicon nitride Si₃N₄

Cutting data for roughing

Shoulder milling with full effective teeth porcupine cutters (F2338F, F4038, F4138, F4238, F4338, F5138)

Material group	Structure of main material groups and code letters		Brinell hardness HB	Tensile strength R_m N/mm ²	Machining group ¹	= Cutting data for wet machining = Dry machining is possible		Cutting material grades			
								Starting values for cutting speed v_c [m/min]			
								HC			
								WKP35S		WKP25S	
a_e / D_c^*		a_e / D_c^*		1/2		1/5					
P	Non-alloyed steel	C ≤ 0.25 %	annealed	125	428	P1	● ●●	195	250	210	275
		C > 0.25... ≤ 0.55 %	annealed	190	639	P2	● ●●	170	215	200	255
		C > 0.25... ≤ 0.55 %	tempered	210	708	P3	● ●●	155	190	175	220
		C > 0.55 %	annealed	190	639	P4	● ●●	170	215	200	255
		C > 0.55 %	tempered	300	1013	P5	● ●●	130	145	165	200
		free cutting steel (short-chipping)	annealed	220	745	P6	● ●●	150	210	170	210
	Low-alloyed steel	annealed	175	591	P7	● ●●	170	215	200	255	
		tempered	300	1013	P8	● ●●	130	145	155	200	
		tempered	380	1282	P9	● ●●	85	100	125	140	
		tempered	430	1477	P10	● ●●	80	90	110	120	
High-alloyed steel and high-alloyed tool steel	annealed	200	675	P11	● ●●	100	120	110	130		
	hardened and tempered	300	1013	P12	● ●●	65	75	80	95		
	hardened and tempered	400	1361	P13	● ●●	60	70	70	80		
Stainless steel	ferritic/martensitic, annealed	200	675	P14	● ●●	105	120				
	martensitic, tempered	330	1114	P15	● ●●	60	70				
M	Stainless steel	austenitic, quench hardened	200	675	M1	●● ●					
		austenitic, precipitation hardened (PH)	300	1013	M2	●● ●					
		austenitic/ferritic, duplex	230	778	M3	●● ●					
K	Malleable cast iron	ferritic	200	675	K1	● ●●	150	170	120	220	
		pearlitic	260	867	K2	● ●●	120	140	130	150	
	Grey cast iron	low tensile strength	180	602	K3	● ●●	160	180	180	230	
		high tensile strength/austenitic	245	825	K4	● ●●	120	140	130	150	
	Cast iron with spheroidal graphite	ferritic	155	518	K5	● ●●	140	150	150	160	
		pearlitic	265	885	K6	● ●●	105	115	120	125	
	GGV (CGI)		200	675	K7	● ●●	150	170	120	220	
N	Aluminium wrought alloys	cannot be hardened	30	–	N1	●●					
		hardenable, hardened	100	343	N2	●●					
	Cast aluminium alloys	≤ 12 % Si, cannot be hardened	75	260	N3	●●					
		≤ 12 % Si, hardenable, hardened	90	314	N4	●●					
		> 12 % Si, cannot be hardened	130	447	N5	●●					
	Magnesium alloys		70	250	N6	●●					
	Copper and copper alloys (bronze/brass)	non-alloyed, electrolytic copper	100	343	N7	●●					
		brass, bronze, red brass	90	314	N8	●●					
		Cu-alloys, short-chipping	110	382	N9	●●					
		high-strength, Ampco	300	1013	N10	●●					
S	Heat-resistant alloys	Fe-based	annealed	200	675	S1	●●				
			hardened	280	943	S2	●●				
		Ni or Co base	annealed	250	839	S3	●●				
			hardened	350	1177	S4	●●				
			cast	320	1076	S5	●●				
	Titanium alloys	pure titanium	200	675	S6	●●					
		α and β alloys, hardened	375	1262	S7	●●					
		β alloys	410	1396	S8	●●					
	Tungsten alloys		300	1013	S9	●●					
	Molybdenum alloys		300	1013	S10	●●					
H	Hardened steel	hardened and tempered	50 HRC	–	H1	●●					
		hardened and tempered	55 HRC	–	H2	●●					
		hardened and tempered	60 HRC	–	H3	●●					
	Hardened cast iron	hardened and tempered	55 HRC	–	H4	●●					
O	Thermoplastics	without abrasive fillers			O1	●● ●	400	400			
	Thermosetting plastics	without abrasive fillers			O2	●● ●	300	300			
	Plastic, glass-fibre reinforced	GFRP			O3						
	Plastic, carbon-fibre reinforced	CFRP			O4						
	Plastic, aramid-fibre reinforced	AFRP			O5						
	Graphite (technical)		80 Shore			O6	●●		400	500	

- Recommended application (the specified cutting data are regarded as starting values for the recommended application).
- Possible application, reduce cutting data by 30–50 % (increase for ISO M approx. 70–80 %).

¹ The classification of the machining groups can be found in the Walter General catalogue 2012 from page H 8 onwards.
 * $a_e/D_c = 1/10$, $v_c = 10$ % higher than 1/5.

The specified cutting data are average recommended values.
For special applications, adjustment is recommended.

Cutting material grades																
Starting values for cutting speed v_c [m/min]																
HC														HW		
WAK15		WSP45		WSP45S		WSM35		WSM35S		WKK25		WXN15		WK10		
a_e / D_c^*		a_e / D_c^*		a_e / D_c^*		a_e / D_c^*		a_e / D_c^*		a_e / D_c^*		a_e / D_c^*		a_e / D_c^*		
1/2	1/5	1/2	1/5	1/2	1/5	1/2	1/5	1/2	1/5	1/2	1/5	1/2	1/5	1/2	1/5	
		185	230	185	230											
		150	200	150	200											
		130	165	130	165											
		150	200	150	200											
		105	115	105	115											
		125	160	125	160											
		150	190	150	190											
		105	115	105	115											
		60	70	60	70											
		60	70	60	70											
		90	110	90	110											
		65	70	65	70											
		60	70	60	70											
		90	110	90	110	95	120	95	120							
		60	70	60	70	60	70	60	70							
		85	100	85	100	100	120	100	120							
		70	80	70	80	80	100	80	100							
		75	90	75	90	90	110	90	110							
	210	270								190	250			70	80	
	160	180								140	160			65	65	
	220	280								200	260			75	85	
	160	180								140	160			55	55	
	180	190								160	170			70	80	
	155	165								135	145			65	65	
	210	270								190	250			70	80	
												1800	1800	1500	1500	
												1440	1440	1200	1200	
												540	640	450	530	
												430	430	360	360	
												220	260	180	215	
												430	430	360	360	
												170	210	140	175	
												280	280	230	230	
												170	210	140	175	
												130	170	100	130	
			50	55	50	55	65	70	65	70						
			35	40	35	40	50	50	50	50						
			40	45	40	45	50	55	50	55						
			25	30	25	30	30	35	30	35						
			30	35	30	35	50	45	50	45						
			50	65	50	65	65	80	65	80						
			30	35	30	35	40	45	40	45						
			25	30	25	30	35	40	35	40						
			30	35	30	35	40	45	40	45						
			25	30	25	30	35	40	35	40						
	45	55								45	55				35	
	40	50								40	50				35	
	40	50								40	50				35	
	400	400	400	400	400	400	400	400	400	400	400	400	400	400	400	
	300	300	300	300	300	300	300	300	300	300	300	300	300	300	300	
	600	800								600	800	600	800	400	500	

HC = Coated carbide
HW = Uncoated carbide
HF = Uncoated fine-grained carbide

BH = CBN with high CBN content
BL = CBN with low CBN content
DP = Polycrystalline diamond
CN = Silicon nitride Si_3N_4

Cutting data for roughing

Slot milling with half effective teeth porcupine cutters (F2237, F2238, F2338)

Material group	Structure of main material groups and code letters		Brinell hardness HB	Tensile strength R_m N/mm ²	Machining group ¹	= Cutting data for wet machining = Dry machining is possible		Cutting material grades	
								Starting values for cutting speed v_c [m/min]	
								HC WKP35S	
						1/1	1/5		
						1/2			
P	Non-alloyed steel	C ≤ 0.25 %	annealed	125	428	P1	● ●●	195	250
		C > 0.25... ≤ 0.55 %	annealed	190	639	P2	● ●●	170	215
		C > 0.25... ≤ 0.55 %	tempered	210	708	P3	● ●●	155	190
		C > 0.55 %	annealed	190	639	P4	● ●●	170	215
		C > 0.55 %	tempered	300	1013	P5	● ●●	130	145
		free cutting steel (short-chipping)	annealed	220	745	P6	● ●●	150	210
	Low-alloyed steel		annealed	175	591	P7	● ●●	170	215
			tempered	300	1013	P8	● ●●	130	145
			tempered	380	1282	P9	● ●●	85	100
			tempered	430	1477	P10	● ●●	80	90
	High-alloyed steel and high-alloyed tool steel		annealed	200	675	P11	● ●●	100	120
			hardened and tempered	300	1013	P12	● ●●	65	75
			hardened and tempered	400	1361	P13	● ●●	60	70
	Stainless steel		ferritic/martensitic, annealed	200	675	P14	● ●●	105	120
			martensitic, tempered	330	1114	P15	● ●●	60	70
M	Stainless steel	austenitic, quench hardened	200	675	M1	●● ●			
		austenitic, precipitation hardened (PH)	300	1013	M2	●● ●			
		austenitic/ferritic, duplex	230	778	M3	●● ●			
K	Malleable cast iron	ferritic	200	675	K1	● ●●	150	170	
		pearlitic	260	867	K2	● ●●	120	140	
	Grey cast iron	low tensile strength	180	602	K3	● ●●	160	180	
		high tensile strength/austenitic	245	825	K4	● ●●	120	140	
	Cast iron with spheroidal graphite	ferritic	155	518	K5	● ●●	140	150	
		pearlitic	265	885	K6	● ●●	105	115	
	GGV (CGI)		200	675	K7	● ●●	150	170	
N	Aluminium wrought alloys	cannot be hardened	30	–	N1	●●			
		hardenable, hardened	100	343	N2	●●			
	Cast aluminium alloys	≤ 12 % Si, cannot be hardened	75	260	N3	●●			
		≤ 12 % Si, hardenable, hardened	90	314	N4	●●			
		> 12 % Si, cannot be hardened	130	447	N5	●●			
	Magnesium alloys		70	250	N6	●●			
	Copper and copper alloys (bronze/brass)	non-alloyed, electrolytic copper	100	343	N7	●●			
		brass, bronze, red brass	90	314	N8	●●			
		Cu-alloys, short-chipping	110	382	N9	●●			
		high-strength, Ampco	300	1013	N10	●●			
S	Heat-resistant alloys	Fe-based	annealed	200	675	S1	●●		
			hardened	280	943	S2	●●		
		Ni or Co base	annealed	250	839	S3	●●		
			hardened	350	1177	S4	●●		
			cast	320	1076	S5	●●		
	Titanium alloys	pure titanium	200	675	S6	●●			
		α and β alloys, hardened	375	1262	S7	●●			
		β alloys	410	1396	S8	●●			
	Tungsten alloys		300	1013	S9	●●			
	Molybdenum alloys		300	1013	S10	●●			
H	Hardened steel	hardened and tempered	50 HRC	–	H1	●●			
		hardened and tempered	55 HRC	–	H2	●●			
		hardened and tempered	60 HRC	–	H3	●●			
	Hardened cast iron	hardened and tempered	55 HRC	–	H4	●●			
O	Thermoplastics	without abrasive fillers			O1	●● ●	400	400	
	Thermosetting plastics	without abrasive fillers			O2	●● ●	300	300	
	Plastic, glass-fibre reinforced	GFRP			O3				
	Plastic, carbon-fibre reinforced	CFRP			O4				
	Plastic, aramid-fibre reinforced	AFRP			O5				
	Graphite (technical)		80 Shore		O6	●●			

- Recommended application (the specified cutting data are regarded as starting values for the recommended application).
- Possible application, reduce cutting data by 30–50 % (increase for ISO M approx. 70–80 %).

¹ The classification of the machining groups can be found in the Walter General catalogue 2012 from page H 8 onwards.
 * $a_e/D_c = 1/10$, $v_c = 10$ % higher than 1/5.

The specified cutting data are average recommended values.
For special applications, adjustment is recommended.

Cutting material grades										
Starting values for cutting speed v_c [m/min]										
HC										
WKP25S		WAK15		WSP45		WSM35		WSM35S		
a_e / D_c^*		a_e / D_c^*		a_e / D_c^*		a_e / D_c^*		a_e / D_c^*		
1/1 1/2	1/5	1/1 1/2	1/5	1/1 1/2	1/5	1/1 1/2	1/5	1/1 1/2	1/5	
210	275			185	230					
200	255			150	200					
175	220			130	165					
200	255			150	200					
165	200			105	115					
170	210			125	160					
200	255			150	190					
155	200			105	115					
125	140			60	70					
120	130			50	60					
110	130			90	110					
80	95			65	70					
80	90			50	60					
				90	110	95	120	95	120	
				60	70	60	70	60	70	
				85	100	100	120	100	120	
				75	90	90	110	90	110	
				75	90	90	110	90	110	
120	220	210	270							
130	150	160	180							
180	230	220	280							
130	150	160	180							
150	160	180	190							
120	125	155	165							
120	220	210	270							
				50	55	65	70	65	70	
				35	40	50	50	50	50	
				40	45	50	55	50	55	
				25	30	30	35	30	35	
				30	35	50	45	50	45	
				50	65	65	80	65	80	
				30	35	40	45	40	45	
				25	30	35	40	35	40	
				30	35	40	45	40	45	
				25	30	35	40	35	40	
				45	55					
				40	50					
				40	50					
400	400	400	400	400	400	400	400	400	400	
300	300	300	300	300	300	300	300	300	300	
400	500									

HC = Coated carbide
HW = Uncoated carbide
HF = Uncoated fine-grained carbide

BH = CBN with high CBN content
BL = CBN with low CBN content
DP = Polycrystalline diamond
CN = Silicon nitride Si_3N_4

Cutting data for roughing

Circular interpolation milling (F2231, F2234, F2330, F2334, F2334R, F3040, F4030, F4042, F4080, F4081)

Material group	Structure of main material groups and code letters		Brinell hardness HB	Tensile strength R_m N/mm ²	Machining group ¹	= Cutting data for wet machining = Dry machining is possible		Cutting material grades				
								Starting values for cutting speed v_c [m/min]				
								HC				
								WKP35S		WKP25S		
		a_e / D_c^*		a_e / D_c^*								
		1/1 1/2		1/5		1/1 1/2		1/5				
P	Non-alloyed steel	C ≤ 0.25 %	annealed	125	428	P1	●	●●	220	270	260	330
		C > 0.25... ≤ 0.55 %	annealed	190	639	P2	●	●●	200	230	230	300
		C > 0.25... ≤ 0.55 %	tempered	210	708	P3	●	●●	210	230	250	310
		C > 0.55 %	annealed	190	639	P4	●	●●	200	230	230	300
		C > 0.55 %	tempered	300	1013	P5	●	●●	140	160	200	230
		free cutting steel (short-chipping)	annealed	220	745	P6	●	●●	190	220	220	290
	Low-alloyed steel	annealed	175	591	P7	●	●●	200	240	230	290	
		tempered	300	1013	P8	●	●●	150	170	190	230	
		tempered	380	1282	P9	●	●●	110	130	140	160	
		tempered	430	1477	P10	●	●●	80	100	110	130	
	High-alloyed steel and high-alloyed tool steel	annealed	200	675	P11	●	●●	120	140	130	150	
		hardened and tempered	300	1013	P12	●	●●	80	90	110	130	
		hardened and tempered	400	1361	P13	●	●●	70	80	100	120	
	Stainless steel	ferritic/martensitic, annealed	200	675	P14	●	●●	120	140			
		martensitic, tempered	330	1114	P15	●	●●	60	70			
M	Stainless steel	austenitic, quench hardened	200	675	M1	●●	●					
		austenitic, precipitation hardened (PH)	300	1013	M2	●●	●					
		austenitic/ferritic, duplex	230	778	M3	●●	●					
K	Malleable cast iron	ferritic	200	675	K1	●	●●	110	120	130	140	
		pearlitic	260	867	K2	●	●●	130	160	150	180	
	Grey cast iron	low tensile strength	180	602	K3	●	●●	270	300	190	310	
		high tensile strength/austenitic	245	825	K4	●	●●	150	180	170	200	
	Cast iron with spheroidal graphite	ferritic	155	518	K5	●	●●	180	200	200	220	
		pearlitic	265	885	K6	●	●●	120	140	130	160	
GGV (CGI)		200	675	K7	●	●●	120	150	140	170		
N	Aluminium wrought alloys	cannot be hardened	30	–	N1	●●						
		hardenable, hardened	100	343	N2	●●						
	Cast aluminium alloys	≤ 12 % Si, cannot be hardened	75	260	N3	●●						
		≤ 12 % Si, hardenable, hardened	90	314	N4	●●						
		> 12 % Si, cannot be hardened	130	447	N5	●●						
	Magnesium alloys		70	250	N6	●●						
	Copper and copper alloys (bronze/brass)	non-alloyed, electrolytic copper	100	343	N7	●●						
brass, bronze, red brass		90	314	N8	●●							
Cu-alloys, short-chipping		110	382	N9	●●							
high-strength, Ampco		300	1013	N10	●●							
S	Heat-resistant alloys	Fe-based	annealed	200	675	S1	●●					
			hardened	280	943	S2	●●					
		Ni or Co base	annealed	250	839	S3	●●					
			hardened	350	1177	S4	●●					
			cast	320	1076	S5	●●					
	Titanium alloys	pure titanium	200	675	S6	●●						
		α and β alloys, hardened	375	1262	S7	●●						
		β alloys	410	1396	S8	●●						
	Tungsten alloys		300	1013	S9	●●						
	Molybdenum alloys		300	1013	S10	●●						
H	Hardened steel	hardened and tempered	50 HRC	–	H1		●●					
		hardened and tempered	55 HRC	–	H2		●●					
		hardened and tempered	60 HRC	–	H3		●●					
	Hardened cast iron	hardened and tempered	55 HRC	–	H4		●●					
O	Thermoplastics	without abrasive fillers			O1	●●	●	300	300			
	Thermosetting plastics	without abrasive fillers			O2	●●	●	400	400			
	Plastic, glass-fibre reinforced	GFRP			O3							
	Plastic, carbon-fibre reinforced	CFRP			O4							
	Plastic, aramid-fibre reinforced	AFRP			O5							
	Graphite (technical)		80 Shore		O6		●●			400	500	

- Recommended application (the specified cutting data are regarded as starting values for the recommended application).
- Possible application, reduce cutting data by 30–50 % (increase for ISO M approx. 70–80 %).

¹ The classification of the machining groups can be found in the Walter General catalogue 2012 from page H 8 onwards.
 * $a_e/D_c = 1/10$, $v_c = 10$ % higher than 1/5.

The specified cutting data are average recommended values.
For special applications, adjustment is recommended.

Cutting material grades																
Starting values for cutting speed v_c [m/min]																
HC																
WAK15		WSP45		WSM35		WSM35S		WKK25		WXN15		HF		HW		
a_e / D_c^*		a_e / D_c^*		a_e / D_c^*		a_e / D_c^*		a_e / D_c^*		a_e / D_c^*		a_e / D_c^*		a_e / D_c^*		
1/1	1/5	1/1	1/5	1/1	1/5	1/1	1/5	1/1	1/5	1/1	1/5	1/1	1/5	1/1	1/5	
1/2		1/2		1/2		1/2		1/2		1/2		1/2		1/2		
			210	260												
			170	220												
			160	210												
			170	220												
			120	130												
			160	210												
			170	210												
			125	150												
			85	95												
			60	65												
			100	130												
			75	90												
			65	75												
			100	120	110	130	110	130								
			55	65	60	70	60	70								
			90	100	100	120	100	120								
			70	80	80	100	80	100								
			80	90	90	110	90	110								
	150	160						140	150							
	160	170						150	160							
	340	370						330	360							
	200	220						190	210							
	230	250						220	240							
	160	190						150	180							
	150	170						140	160							
										2640	2640	1500	1500	2200	2200	
										1780	1780	900	900	1500	1500	
										600	660			500	540	
										480	480			400	400	
										240	280			200	230	
										480	480			400	400	
										180	200			150	160	
										240	280			200	230	
										180	200			150	160	
										240	280			200	230	
			60	65	70	80	70	80				67	72			
			40	45	55	60	55	60				40	45			
			45	50	55	65	55	65				50	55			
			27	32	35	40	35	40				22	27			
			35	40	45	50	45	50				30	35			
			65	80	80	100	80	100				70	80			
			40	45	50	55	50	55				45	50			
			35	40	45	50	45	50								
			40	45	50	55	50	55								
			35	40	45	50	45	50								
	45	55						45	55						35	
	45	55						45	55						35	
	45	55						45	55						35	
	300	300	300	300	300	300	300	300	300	300	300	300	300	300	300	
	400	400	400	400	400	400	400	400	400	400	400	400	400	400	400	
	600	800						600	800	600	800			400	500	

HC = Coated carbide
HW = Uncoated carbide
HF = Uncoated fine-grained carbide

BH = CBN with high CBN content
BL = CBN with low CBN content
DP = Polycrystalline diamond
CN = Silicon nitride Si₃N₄

Cutting data for roughing

Slot milling with side and face milling cutters

Material group	Structure of main material groups and code letters		Brinell hardness HB	Tensile strength R_m N/mm ²	Machining group ¹	= Cutting data for wet machining = Dry machining is possible		Cutting material grades				
								Starting values for cutting speed v_c [m/min]				
								HC				
								WKP35S		WKP25S		
		a_e / D_c		a_e / D_c								
		1/4*	1/10	1/4*	1/10							
P	Non-alloyed steel	C ≤ 0.25 %	annealed	125	428	P1	●	●●	195	250	210	285
		C > 0.25... ≤ 0.55 %	annealed	190	639	P2	●	●●	170	215	200	255
		C > 0.25... ≤ 0.55 %	tempered	210	708	P3	●	●●	160	205	185	230
		C > 0.55 %	annealed	190	639	P4	●	●●	160	200	185	230
		C > 0.55 %	tempered	300	1013	P5	●	●●	130	145	165	200
		free cutting steel (short-chipping)	annealed	220	745	P6	●	●●	160	205	190	245
	Low-alloyed steel	annealed	175	591	P7	●	●●	170	215	200	255	
		tempered	300	1013	P8	●	●●	125	145	155	200	
		tempered	380	1282	P9	●	●●	85	95	125	140	
		tempered	430	1477	P10	●	●●	80	90	120	130	
	High-alloyed steel and high-alloyed tool steel	annealed	200	675	P11	●	●●	100	120	110	145	
		hardened and tempered	300	1013	P12	●	●●	65	80	75	100	
		hardened and tempered	400	1361	P13	●	●●	60	70	70	90	
	Stainless steel	ferritic/martensitic, annealed	200	675	P14	●	●●	105	130			
		martensitic, tempered	330	1114	P15	●	●●	60	85			
M	Stainless steel	austenitic, quench hardened	200	675	M1	●●	●					
		austenitic, precipitation hardened (PH)	300	1013	M2	●●	●					
		austenitic/ferritic, duplex	230	778	M3	●●	●					
K	Malleable cast iron	ferritic	200	675	K1	●	●●	140	155	155	180	
		pearlitic	260	867	K2	●	●●	135	145	100	155	
	Grey cast iron	low tensile strength	180	602	K3	●	●●	160	180	180	230	
		high tensile strength/austenitic	245	825	K4	●	●●	120	140	130	150	
	Cast iron with spheroidal graphite	ferritic	155	518	K5	●	●●	140	150	170	190	
		pearlitic	265	885	K6	●	●●	110	120	110	150	
	GGV (CGI)		200	675	K7	●	●●	120	135	120	165	
N	Aluminium wrought alloys	cannot be hardened	30	–	N1	●●						
		hardenable, hardened	100	343	N2	●●						
	Cast aluminium alloys	≤ 12 % Si, cannot be hardened	75	260	N3	●●						
		≤ 12 % Si, hardenable, hardened	90	314	N4	●●						
		> 12 % Si, cannot be hardened	130	447	N5	●●						
	Magnesium alloys		70	250	N6	●●						
	Copper and copper alloys (bronze/brass)	non-alloyed, electrolytic copper	100	343	N7	●●						
		brass, bronze, red brass	90	314	N8	●●						
		Cu-alloys, short-chipping	110	382	N9	●●						
		high-strength, Ampco	300	1013	N10	●●						
S	Heat-resistant alloys	Fe-based	annealed	200	675	S1	●●					
			hardened	280	943	S2	●●					
		Ni or Co base	annealed	250	839	S3	●●					
			hardened	350	1177	S4	●●					
			cast	320	1076	S5	●●					
	Titanium alloys	pure titanium	200	675	S6	●●						
		α and β alloys, hardened	375	1262	S7	●●						
		β alloys	410	1396	S8	●●						
	Tungsten alloys		300	1013	S9	●●						
	Molybdenum alloys		300	1013	S10	●●						
H	Hardened steel	hardened and tempered	50 HRC	–	H1		●●					
		hardened and tempered	55 HRC	–	H2		●●					
		hardened and tempered	60 HRC	–	H3		●●					
	Hardened cast iron	hardened and tempered	55 HRC	–	H4		●●					
O	Thermoplastics	without abrasive fillers			O1	●●	●	400	400			
	Thermosetting plastics	without abrasive fillers			O2	●●	●	300	300			
	Plastic, glass-fibre reinforced	GFRP			O3							
	Plastic, carbon-fibre reinforced	CFRP			O4							
	Plastic, aramid-fibre reinforced	AFRP			O5							
	Graphite (technical)		80 Shore		O6		●●			400	500	

●● Recommended application (the specified cutting data are regarded as starting values for the recommended application).

● Possible application, reduce cutting data by 30–50 % (increase for ISO M approx. 70–80 %).

¹ The classification of the machining groups can be found in the Walter General catalogue 2012 from page H 8 onwards.

* $a_e = a_{e \max}$

The specified cutting data are average recommended values.
For special applications, adjustment is recommended.

Cutting material grades																		
Starting values for cutting speed v_c [m/min]																		
HC																		
WAK15		WSP45		WSM43S		WSM35		WSM33S		WSM35S		WKK25		WXN15		WK10		
a_e / D_c		a_e / D_c		a_e / D_c		a_e / D_c		a_e / D_c		a_e / D_c		a_e / D_c^*		a_e / D_c^*		a_e / D_c^*		
1/4*	1/10	1/4*	1/10	1/4*	1/10	1/4*	1/10	1/4*	1/10	1/4*	1/10	1/4*	1/10	1/4*	1/10	1/4*	1/10	
			185	230	185	230	185	230	185	230								
			150	200	150	200	150	200	150	200								
			135	170	135	170	135	170	135	170								
			135	170	135	170	135	170	135	170								
			105	125	105	125	105	125	105	125								
			140	180	140	180	140	180	140	180								
			150	190	150	190	150	190	150	190								
			105	115	105	115	105	115	105	115								
			75	85	75	85	75	85	75	85								
			65	75	65	75	65	75	65	75								
			90	110	90	110	90	110	90	110								
			60	70	60	70	60	70	60	70								
			55	65	55	65	55	65	55	65								
			90	110	90	110	90	110	90	110	95	120						
			60	80	60	80	60	80	60	80	65	85						
			85	100	85	100	85	100	85	100	100	120						
			70	85	70	85	70	85	70	85	85	100						
			75	90	75	90	75	90	75	90	90	110						
	150	200											160	200				
	120	170											110	170				
	220	280											200	250				
	160	180											145	165				
	180	190											185	210				
	150	160											120	165				
	165	175											130	170				
															1800	1800	1500	1500
															1440	1440	1200	1200
															540	640	450	530
															430	430	360	360
															220	280	180	230
															430	430	360	360
															170	210	140	175
															280	280	230	230
															385	385	320	320
															150	190	120	160
			55	60	55	60	55	60	55	60	70	80						
			40	45	40	45	40	45	40	45	50	55						
			45	50	45	50	45	50	45	50	55	60						
			30	35	30	35	30	35	30	35	35	40						
			35	40	35	40	35	40	35	40	45	50						
			55	60	55	60	55	60	55	60	70	80						
			30	35	30	35	30	35	30	35	40	45						
			25	30	25	30	25	30	25	30	35	40						
			30	35	30	35	30	35	30	35	40	45						
			25	30	25	30	25	30	25	30	35	40						
	50	60											50	60			40	40
	40	50											40	50			35	35
	40	50											40	50			35	35
	400	400	400	400	400	400	400	400	400	400	400	400	400	400	400	400	400	400
	300	300	300	300	300	300	300	300	300	300	300	300	300	300	300	300	300	300
	600	800											600	800	600	800	400	500

HC = Coated carbide
HW = Uncoated carbide
HF = Uncoated fine-grained carbide

BH = CBN with high CBN content
BL = CBN with low CBN content
DP = Polycrystalline diamond
CN = Silicon nitride Si_3N_4

Cutting data for roughing

Copy milling

Material group	Structure of main material groups and code letters		Brinell hardness HB	Tensile strength R_m N/mm ²	Machining group ¹		Cutting material grades				
							Starting values for cutting speed v_c [m/min]				
							HC WKP35S a_e / D_c				
			1/1	1/5	1/10						
P	Non-alloyed steel	C ≤ 0.25 %	annealed	125	428	P1	● ●●	240	300	300	
		C > 0.25... ≤ 0.55 %	annealed	190	639	P2	● ●●	200	255	275	
		C > 0.25... ≤ 0.55 %	tempered	210	708	P3	● ●●	185	240	240	
		C > 0.55 %	annealed	190	639	P4	● ●●	155	195	210	
		C > 0.55 %	tempered	300	1013	P5	● ●●	145	180	185	
		free cutting steel (short-chipping)	annealed	220	745	P6	● ●●	200	255	275	
	Low-alloyed steel		annealed	175	591	P7	● ●●	165	210	230	
			tempered	300	1013	P8	● ●●	155	195	215	
			tempered	380	1282	P9	● ●●	145	180	200	
			tempered	430	1477	P10	● ●●	120	155	170	
	High-alloyed steel and high-alloyed tool steel		annealed	200	675	P11	● ●●	110	145	160	
			hardened and tempered	300	1013	P12	● ●●	75	100	100	
			hardened and tempered	400	1361	P13	● ●●	65	80	90	
	Stainless steel		ferritic/martensitic, annealed	200	675	P14	● ●●	120	155	170	
			martensitic, tempered	330	1114	P15	● ●●	110	145	155	
M	Stainless steel	austenitic, quench hardened	200	675	M1	●● ●					
		austenitic, precipitation hardened (PH)	300	1013	M2	●● ●					
		austenitic/ferritic, duplex	230	778	M3	●● ●					
K	Malleable cast iron	ferritic	200	675	K1	● ●●	250	290	310		
		pearlitic	260	867	K2	● ●●	200	240	260		
	Grey cast iron	low tensile strength	180	602	K3	● ●●	240	280	300		
		high tensile strength/austenitic	245	825	K4	● ●●	190	230	250		
	Cast iron with spheroidal graphite	ferritic	155	518	K5	● ●●	240	280	300		
		pearlitic	265	885	K6	● ●●	190	230	250		
	GGV (CGI)		200	675	K7	● ●●	180	220	250		
N	Aluminium wrought alloys	cannot be hardened	30	–	N1	●●					
		hardenable, hardened	100	343	N2	●●					
	Cast aluminium alloys	≤ 12 % Si, cannot be hardened	75	260	N3	●●					
		≤ 12 % Si, hardenable, hardened	90	314	N4	●●					
		> 12 % Si, cannot be hardened	130	447	N5	●●					
	Magnesium alloys		70	250	N6	●●					
	Copper and copper alloys (bronze/brass)	non-alloyed, electrolytic copper	100	343	N7	●●					
brass, bronze, red brass		90	314	N8	●●						
Cu-alloys, short-chipping		110	382	N9	●●						
high-strength, Ampco		300	1013	N10	●●						
S	Heat-resistant alloys	Fe-based	annealed	200	675	S1	●●				
			hardened	280	943	S2	●●				
		Ni or Co base	annealed	250	839	S3	●●				
			hardened	350	1177	S4	●●				
			cast	320	1076	S5	●●				
	Titanium alloys	pure titanium	200	675	S6	●●					
		α and β alloys, hardened	375	1262	S7	●●					
		β alloys	410	1396	S8	●●					
	Tungsten alloys		300	1013	S9	●●					
	Molybdenum alloys		300	1013	S10	●●					
H	Hardened steel	hardened and tempered	50 HRC	–	H1	●●					
		hardened and tempered	55 HRC	–	H2	●●					
		hardened and tempered	60 HRC	–	H3	●●					
	Hardened cast iron	hardened and tempered	55 HRC	–	H4	●●					
O	Thermoplastics	without abrasive fillers			O1	●● ●	400	450	500		
	Thermosetting plastics	without abrasive fillers			O2	●● ●	300	350	400		
	Plastic, glass-fibre reinforced	GFRP			O3						
	Plastic, carbon-fibre reinforced	CFRP			O4						
	Plastic, aramid-fibre reinforced	AFRP			O5						
	Graphite (technical)		80 Shore		O6	●●					

- Recommended application (the specified cutting data are regarded as starting values for the recommended application).
- Possible application, reduce cutting data by 30–50 % (increase for ISO M approx. 70–80 %).

¹ The classification of the machining groups can be found in the Walter General catalogue 2012 from page H 8 onwards.

Cutting data for roughing

Copy milling

Material group	Structure of main material groups and code letters		Brinell hardness HB	Tensile strength R_m N/mm ²	Machining group ¹		Cutting material grades				
							Starting values for cutting speed v_c [m/min]				
							HC WKK25 a_e / D_c				
			1/1	1/5	1/10						
P	Non-alloyed steel	C ≤ 0.25 %	annealed	125	428	P1	●	●●			
		C > 0.25... ≤ 0.55 %	annealed	190	639	P2	●	●●			
		C > 0.25... ≤ 0.55 %	tempered	210	708	P3	●	●●			
		C > 0.55 %	annealed	190	639	P4	●	●●			
		C > 0.55 %	tempered	300	1013	P5	●	●●			
		free cutting steel (short-chipping)	annealed	220	745	P6	●	●●			
	Low-alloyed steel		annealed	175	591	P7	●	●●			
			tempered	300	1013	P8	●	●●			
			tempered	380	1282	P9	●	●●			
			tempered	430	1477	P10	●	●●			
	High-alloyed steel and high-alloyed tool steel		annealed	200	675	P11	●	●●			
			hardened and tempered	300	1013	P12	●	●●			
			hardened and tempered	400	1361	P13	●	●●			
	Stainless steel		ferritic/martensitic, annealed	200	675	P14	●	●●			
			martensitic, tempered	330	1114	P15	●	●●			
M	Stainless steel	austenitic, quench hardened	200	675	M1	●●	●				
		austenitic, precipitation hardened (PH)	300	1013	M2	●●	●				
		austenitic/ferritic, duplex	230	778	M3	●●	●				
K	Malleable cast iron	ferritic	200	675	K1	●	●●	330	375	405	
		pearlitic	260	867	K2	●	●●	285	330	360	
	Grey cast iron	low tensile strength	180	602	K3	●	●●	315	360	375	
		high tensile strength/austenitic	245	825	K4	●	●●	270	315	330	
	Cast iron with spheroidal graphite	ferritic	155	518	K5	●	●●	315	360	375	
		pearlitic	265	885	K6	●	●●	270	315	330	
	GGV (CGI)		200	675	K7	●	●●	260	300	330	
N	Aluminium wrought alloys	cannot be hardened	30	–	N1	●●					
		hardenable, hardened	100	343	N2	●●					
	Cast aluminium alloys	≤ 12 % Si, cannot be hardened	75	260	N3	●●					
		≤ 12 % Si, hardenable, hardened	90	314	N4	●●					
		> 12 % Si, cannot be hardened	130	447	N5	●●					
	Magnesium alloys			70	250	N6	●●				
		Copper and copper alloys (bronze/brass)	non-alloyed, electrolytic copper	100	343	N7	●●				
			brass, bronze, red brass	90	314	N8	●●				
			Cu-alloys, short-chipping	110	382	N9	●●				
			high-strength, Ampco	300	1013	N10	●●				
S	Heat-resistant alloys	Fe-based	annealed	200	675	S1	●●				
			hardened	280	943	S2	●●				
		Ni or Co base	annealed	250	839	S3	●●				
			hardened	350	1177	S4	●●				
			cast	320	1076	S5	●●				
	Titanium alloys	pure titanium	200	675	S6	●●					
		α and β alloys, hardened	375	1262	S7	●●					
		β alloys	410	1396	S8	●●					
	Tungsten alloys		300	1013	S9	●●					
	Molybdenum alloys		300	1013	S10	●●					
H	Hardened steel	hardened and tempered	50 HRC	–	H1		●●				
		hardened and tempered	55 HRC	–	H2		●●				
		hardened and tempered	60 HRC	–	H3		●●				
	Hardened cast iron	hardened and tempered	55 HRC	–	H4		●●				
O	Thermoplastics	without abrasive fillers			O1	●●	●	600	700	800	
	Thermosetting plastics	without abrasive fillers			O2	●●	●	500	600	700	
	Plastic, glass-fibre reinforced	GFRP			O3						
	Plastic, carbon-fibre reinforced	CFRP			O4						
	Plastic, aramid-fibre reinforced	AFRP			O5						
	Graphite (technical)		80 Shore		O6		●●	500	600	700	

- Recommended application (the specified cutting data are regarded as starting values for the recommended application).
- Possible application, reduce cutting data by 30–50 % (increase for ISO M approx. 70–80 %).

¹ The classification of the machining groups can be found in the Walter General catalogue 2012 from page H 8 onwards.

The specified cutting data are average recommended values.
For special applications, adjustment is recommended.

Cutting material grades												
Starting values for cutting speed v_c [m/min]												
WCN15			HC			HF			HW			
a_e / D_c			a_e / D_c			a_e / D_c			a_e / D_c			
1/1	1/5	1/10	1/1	1/5	1/10	1/1	1/5	1/10	1/1	1/5	1/10	
				170	225	305						
				150	200	270						
				120	160	220						
				105	140	190						
				80	105	145						
				120	160	220						
				140	185	250						
				120	160	220						
				110	150	200						
				105	140	190						
				105	140	190						
				100	130	180						
				80	100	140						
				120	160	220						
				100	130	180						
				105	140	190						
				90	120	160						
				110	150	200						
				90	120	160						
				110	150	200						
				90	130	180						
				80	110	150						
	1920	1920	2110				1600	1600	1760	2000	2000	2200
	1440	1440	1630				1200	1200	1360	1500	1500	1700
	480	530	580				400	440	480	500	550	600
	385	385	420				320	320	350	400	400	440
	190	225	250				160	190	210	200	235	260
	480	530	580				400	440	480	500	550	600
	240	310	340				200	260	280	250	320	355
	260	325	360				220	270	300	270	340	375
	365	465	515				305	390	430	380	485	535
	210	280	340				170	230	280	190	260	320
							50	55	60			
							40	45	50			
							30	35	40			
							70	90	100			
							30	40	45			
							30	40	45			
							40	45	50			
							40	45	50			
				50	65	85						
				35	50	70						
				35	45	60						
				40	55	80						
	700	800	900	700	800	900	650	800	900	700	850	950
	580	735	810	600	700	800	550	700	800	600	765	840
	600	700	800	600	700	800						

HC = Coated carbide
HW = Uncoated carbide
HF = Uncoated fine-grained carbide

BH = CBN with high CBN content
BL = CBN with low CBN content
DP = Polycrystalline diamond
CN = Silicon nitride Si_3N_4

Cutting data for semi-finishing and finishing

Copy milling

Material group	Structure of main material groups and code letters		Brinell hardness HB	Tensile strength R_m N/mm ²	Machining group ¹		Cutting material grades					
							Starting values for cutting speed v_c [m/min]					
							HC WKP35S a_e / D_c^*					
			1/1	1/5	1/20							
P	Non-alloyed steel	C ≤ 0.25 %	annealed	125	428	P1	●	●●	210	275	375	
		C > 0.25... ≤ 0.55 %	annealed	190	639	P2	●	●●	185	255	340	
		C > 0.25... ≤ 0.55 %	tempered	210	708	P3	●	●●	145	185	260	
		C > 0.55 %	annealed	190	639	P4	●	●●	120	165	220	
		C > 0.55 %	tempered	300	1013	P5	●	●●	90	120	160	
		free cutting steel (short-chipping)	annealed	220	745	P6	●	●●	190	260	340	
	Low-alloyed steel		annealed	175	591	P7	●	●●	165	220	295	
			tempered	300	1013	P8	●	●●	145	185	260	
			tempered	380	1282	P9	●	●●	130	175	240	
			tempered	430	1477	P10	●	●●	120	165	220	
	High-alloyed steel and high-alloyed tool steel		annealed	200	675	P11	●	●●	130	175	240	
			hardened and tempered	300	1013	P12	●	●●	120	165	220	
			hardened and tempered	400	1361	P13	●	●●	90	120	160	
	Stainless steel		ferritic/martensitic, annealed	200	675	P14	●	●●	145	185	260	
			martensitic, tempered	330	1114	P15	●	●●	110	1745	200	
M	Stainless steel		austenitic, quench hardened	200	675	M1	●●	●				
			austenitic, precipitation hardened (PH)	300	1013	M2	●●	●				
			austenitic/ferritic, duplex	230	778	M3	●●	●				
K	Malleable cast iron		ferritic	200	675	K1	●	●●	170	230	290	
			pearlitic	260	867	K2	●	●●	140	200	250	
	Grey cast iron		low tensile strength	180	602	K3	●	●●	190	250	300	
			high tensile strength/austenitic	245	825	K4	●	●●	140	200	250	
	Cast iron with spheroidal graphite		ferritic	155	518	K5	●	●●	190	250	300	
			pearlitic	265	885	K6	●	●●	150	210	260	
		GGV (CGI)		200	675	K7	●	●●	130	190	240	
N	Aluminium wrought alloys		cannot be hardened	30	–	N1	●●					
			hardenable, hardened	100	343	N2	●●					
	Cast aluminium alloys		≤ 12 % Si, cannot be hardened	75	260	N3	●●					
			≤ 12 % Si, hardenable, hardened	90	314	N4	●●					
			> 12 % Si, cannot be hardened	130	447	N5	●●					
	Magnesium alloys			70	250	N6	●●					
	Copper and copper alloys (bronze/brass)		non-alloyed, electrolytic copper	100	343	N7	●●					
			brass, bronze, red brass	90	314	N8	●●					
			Cu-alloys, short-chipping	110	382	N9	●●					
			high-strength, Ampco	300	1013	N10	●●					
S	Heat-resistant alloys	Fe-based	annealed	200	675	S1	●●					
			hardened	280	943	S2	●●					
		Ni or Co base	annealed	250	839	S3	●●					
			hardened	350	1177	S4	●●					
			cast	320	1076	S5	●●					
	Titanium alloys		pure titanium	200	675	S6	●●					
			α and β alloys, hardened	375	1262	S7	●●					
			β alloys	410	1396	S8	●●					
	Tungsten alloys			300	1013	S9	●●					
	Molybdenum alloys			300	1013	S10	●●					
H	Hardened steel		hardened and tempered	50 HRC	–	H1		●●				
			hardened and tempered	55 HRC	–	H2		●●				
			hardened and tempered	60 HRC	–	H3		●●				
	Hardened cast iron		hardened and tempered	55 HRC	–	H4		●●				
O	Thermoplastics		without abrasive fillers			O1	●●	●	450	500	550	
	Thermosetting plastics		without abrasive fillers			O2	●●	●	350	400	450	
	Plastic, glass-fibre reinforced		GFRP			O3						
	Plastic, carbon-fibre reinforced		CFRP			O4						
	Plastic, aramid-fibre reinforced		AFRP			O5						
	Graphite (technical)			80 Shore		O6						

- Recommended application (the specified cutting data are regarded as starting values for the recommended application).
- Possible application, reduce cutting data by 30–50 % (increase for ISO M approx. 70–80 %).

¹ The classification of the machining groups can be found in the Walter General catalogue 2012 from page H 8 onwards.

* $a_e/D_c = 1/50$, $v_c = 40$ % higher than 1/20.

Cutting data for semi-finishing and finishing

Copy milling

Material group	Structure of main material groups and code letters		Brinell hardness HB	Tensile strength R_m N/mm ²	Machining group ¹		Cutting material grades				
							Starting values for cutting speed v_c [m/min]				
							HC WKK25 a_e / D_c^*				
			1/1	1/5	1/20						
P	Non-alloyed steel	C ≤ 0.25 %	annealed	125	428	P1	●	●●			
		C > 0.25... ≤ 0.55 %	annealed	190	639	P2	●	●●			
		C > 0.25... ≤ 0.55 %	tempered	210	708	P3	●	●●			
		C > 0.55 %	annealed	190	639	P4	●	●●			
		C > 0.55 %	tempered	300	1013	P5	●	●●			
		free cutting steel (short-chipping)	annealed	220	745	P6	●	●●			
	Low-alloyed steel		annealed	175	591	P7	●	●●			
			tempered	300	1013	P8	●	●●			
			tempered	380	1282	P9	●	●●			
			tempered	430	1477	P10	●	●●			
	High-alloyed steel and high-alloyed tool steel		annealed	200	675	P11	●	●●			
			hardened and tempered	300	1013	P12	●	●●			
			hardened and tempered	400	1361	P13	●	●●			
	Stainless steel		ferritic/martensitic, annealed	200	675	P14	●	●●			
			martensitic, tempered	330	1114	P15	●	●●			
M	Stainless steel		austenitic, quench hardened	200	675	M1	●●	●			
			austenitic, precipitation hardened (PH)	300	1013	M2	●●	●			
			austenitic/ferritic, duplex	230	778	M3	●●	●			
K	Malleable cast iron		ferritic	200	675	K1	●	●●	250	340	430
			pearlitic	260	867	K2	●	●●	225	280	375
	Grey cast iron		low tensile strength	180	602	K3	●	●●	270	360	450
			high tensile strength/austenitic	245	825	K4	●	●●	225	280	375
	Cast iron with spheroidal graphite		ferritic	155	518	K5	●	●●	270	360	450
			pearlitic	265	885	K6	●	●●	230	280	410
		GGV (CGI)		200	675	K7	●	●●	210	270	360
N	Aluminium wrought alloys		cannot be hardened	30	–	N1	●●				
			hardenable, hardened	100	343	N2	●●				
	Cast aluminium alloys		≤ 12 % Si, cannot be hardened	75	260	N3	●●				
			≤ 12 % Si, hardenable, hardened	90	314	N4	●●				
			> 12 % Si, cannot be hardened	130	447	N5	●●				
	Magnesium alloys			70	250	N6	●●				
	Copper and copper alloys (bronze/brass)		non-alloyed, electrolytic copper	100	343	N7	●●				
			brass, bronze, red brass	90	314	N8	●●				
			Cu-alloys, short-chipping	110	382	N9	●●				
			high-strength, Ampco	300	1013	N10	●●				
S	Heat-resistant alloys	Fe-based	annealed	200	675	S1	●●				
			hardened	280	943	S2	●●				
		Ni or Co base	annealed	250	839	S3	●●				
			hardened	350	1177	S4	●●				
			cast	320	1076	S5	●●				
	Titanium alloys		pure titanium	200	675	S6	●●				
			α and β alloys, hardened	375	1262	S7	●●		35	45	60
			β alloys	410	1396	S8	●●				
	Tungsten alloys			300	1013	S9	●●				
	Molybdenum alloys			300	1013	S10	●●				
H	Hardened steel		hardened and tempered	50 HRC	–	H1		●●			
			hardened and tempered	55 HRC	–	H2		●●			
			hardened and tempered	60 HRC	–	H3		●●			
	Hardened cast iron		hardened and tempered	55 HRC	–	H4		●●			
O	Thermoplastics		without abrasive fillers			O1	●●	●	700	800	900
	Thermosetting plastics		without abrasive fillers			O2	●●	●	600	700	800
	Plastic, glass-fibre reinforced		GFRP			O3					
	Plastic, carbon-fibre reinforced		CFRP			O4					
	Plastic, aramid-fibre reinforced		AFRP			O5					
	Graphite (technical)			80 Shore			O6		●●	600	700

- Recommended application (the specified cutting data are regarded as starting values for the recommended application).
- Possible application, reduce cutting data by 30–50 % (increase for ISO M approx. 70–80 %).

¹ The classification of the machining groups can be found in the Walter General catalogue 2012 from page H 8 onwards.
 * $a_e/D_c = 1/50$, $v_c = 40$ % higher than 1/20.

The specified cutting data are average recommended values.
For special applications, adjustment is recommended.

Cutting material grades														
Starting values for cutting speed v_c [m/min]														
WXN15			HC			WHH15			HF			HW		
a_e / D_c^*			a_e / D_c^*			a_e / D_c^*			a_e / D_c^*			a_e / D_c^*		
1/1	1/5	1/20	1/1	1/5	1/20	1/1	1/5	1/20	1/1	1/5	1/20	1/1	1/5	1/20
				210	280	380								
				190	250	340								
				150	200	270								
				130	170	235								
				100	130	180								
				180	240	330								
				170	230	310								
				150	200	270								
				140	190	250								
				130	170	235								
				130	170	235								
				120	160	220								
				110	150	210								
				150	200	270								
				120	160	220								
				130	170	235								
				110	150	200								
				140	190	250								
				110	150	200								
				140	190	250								
				120	160	220								
				110	150	200								
	2400	2400	2640				1600	1600	1760	2000	2000	2200		
	1800	1800	2040				1200	1200	1360	1500	1500	1700		
	600	660	720				400	440	480	500	550	600		
	480	480	530				320	320	350	400	400	440		
	240	280	310				160	190	210	200	235	260		
	600	660	720				400	440	480	500	550	600		
	460	580	640				305	390	430	380	485	535		
	320	410	450				220	270	300	270	340	375		
	300	380	430				200	260	280	250	320	355		
	200	240	270				120	150	180	160	200	230		
							55	60	65					
							45	50	55					
							30	40	45					
							80	100	110					
							30	45	50					
				60	80	110								
				40	50	70								
				40	45	60								
				50	70	90								
	800	1000	1100	800	900	1000	600	700	750	700	800	900		
	720	920	1010	700	800	900	480	610	670	600	765	840		
	600	700	900	700	800	1000				400	500	700		

HC = Coated carbide
HW = Uncoated carbide
HF = Uncoated fine-grained carbide

BH = CBN with high CBN content
BL = CBN with low CBN content
DP = Polycrystalline diamond
CN = Silicon nitride Si_3N_4

Feed determination (starting values) Face/shoulder milling cutter

Mill type		F 4045	F 4050	
Material group	<p>Feed per tooth f_{z0} for $a_e = D_c$ $a_p = a_{p \max} = L_c$</p>	<p>Xtra-tec®</p>		
	Lead angle κ	45°	75° + 90°	
	Page	F-54	F-58	
		f_{z0} [mm]	f_{z0} [mm]	
	Tool \emptyset or \emptyset range [mm]	63–200	80–200	79,4–200
Maximum cutting data $a_{p \max} = L_c$ [mm]	4	6	1,1 / 4,0	
P	Non-alloyed steel ¹			
	Low-alloyed steel			
	High-alloyed steel and tool steel			
	Stainless steel			
M	Stainless steel ²			
K	Malleable cast iron	0,25	0,30	
	Grey cast iron	0,30	0,50	
	Cast iron with spheroidal graphite	0,25	0,40	
	GGV (CGI)	0,20	0,25	
N	Aluminium wrought alloys		0,15	
	Cast aluminium alloys		0,15	
	Magnesium alloys		0,15	
	Copper and copper alloys (bronze/brass)		0,10	
S	Heat-resistant alloys			
	Titanium alloys			
	Tungsten alloys			
	Molybdenum alloys			
H	Hardened steel			
	Hardened cast iron			
O	Thermoplastics			
	Plastic, carbon-fibre reinforced			
	Graphite (technical)			
Insert types		XNHF 0705 ..	XNHF 0906 ..	
Correction factor K_{a_e}	$a_e / D_c =$	1,0	1,0	FR 733 FR 734
		1,1	1,1	1,1
		1,2	1,2	1,2
		1,3	1,3	1,3
		1,50		
Correction factor K_{a_p}	$a_p =$			
$f_z = f_{z0} \cdot K_{a_e} \cdot K_{a_p}$	$a_{p \max} = L_c$			

¹ and cast steel

² and austenitic/ferritic

Feed determination (starting values)

Shoulder mill – Porcupine cutter, full effective teeth

The specified feed rates are average recommended values.
For special applications, adjustment is recommended.

Mill type		F 2010 / F 4042	F 5 . 41			F 5138	
<p>Feed per tooth f_{z0} for $a_e = D_c$ $a_p = a_{p \max} = L_c$</p>		<p>Xtra-tec®</p>	<p>Walter BLAXX</p>			<p>Walter BLAXX</p>	
Lead angle κ		90°	90°			90°	
Page		F-68	F-72			F-78	
Material group		f_{z0} [mm] F 2010 F 4042	f_{z0} [mm] F5041 F5141 F5241			f_{z0} [mm]	
	Tool \emptyset or \emptyset range [mm]	40–315	25–63	40–125	50–160	40–80	
	Maximum cutting data $a_{p \max} = L_c$ [mm]	15	8,4	12,2	15,2	23–56	
P	Non-alloyed steel ¹	0,25	0,18	0,24	0,28	0,23	
	Low-alloyed steel	0,18	0,12	0,18	0,22	0,17	
	High-alloyed steel and tool steel	0,18	0,12	0,18	0,22	0,17	
	Stainless steel	0,15	0,10	0,14	0,16	0,12	
M	Stainless steel ²	0,12	0,10	0,12	0,14	0,11	
K	Malleable cast iron	0,25	0,14	0,24	0,28	0,23	
	Grey cast iron	0,30	0,18	0,30	0,35	0,28	
	Cast iron with spheroidal graphite	0,25	0,14	0,24	0,28	0,22	
	GGV (CGI)	0,18	0,12	0,18	0,20	0,17	
N	Aluminium wrought alloys	0,15	0,12	0,15	0,15	0,15	
	Cast aluminium alloys	0,15	0,15	0,15	0,15	0,12	
	Magnesium alloys	0,15	0,12	0,15	0,15	0,12	
	Copper and copper alloys (bronze/brass)	0,12	0,10	0,12	0,12	0,12	
S	Heat-resistant alloys	0,15	0,10	0,14	0,17	0,12	
	Titanium alloys	0,15	0,10	0,14	0,17	0,12	
	Tungsten alloys	0,15	0,10	0,14	0,17	0,12	
	Molybdenum alloys	0,15	0,10	0,14	0,17	0,12	
H	Hardened steel						
	Hardened cast iron						
O	Thermoplastics	0,20					
	Plastic, carbon-fibre reinforced						
	Graphite (technical)	0,15	0,12	0,18	0,18	0,15	
Insert types		AD . T 1606 . .	LN . . 0904 . .	LN . . 1306 . .	LN . . 1607 . .	LNHU 1306 . .	
Correction factor K_{a_e}	$a_e / D_c = 1/2$	1,0	1,0	1,0	1,0	1,0**	
	$1/5$	1,1	1,1	1,1	1,1	1,1	
	For the feed per tooth depending on the ratio of cut width a_e to cutter diameter D_c	$1/10$	1,2	1,2	1,2	1,2	1,2
	$1/20$	1,3	1,3	1,3	1,3	1,3	
Correction factor K_{a_p}	$a_p = 6$					1,0	
	9					1,0	
	For the feed per tooth dependant on the cutting depth a_p	12				1,0	
	$0,5 \times D_c$					1,0	
	$0,75 \times D_c$					0,8	
$f_z = f_{z0} \cdot K_{a_e} \cdot K_{a_p}$	$1 \times D_c$					0,7	
	$a_{p \max} = L_c$					0,5*	

¹ and cast steel
² and austenitic/ferritic
 * Only possible if $a_e/D_c < 1/5$
 ** Only possible if $a_p < 0,75 \times D_c$

Feed determination (starting values) Side and face milling cutters

Mill type		F 5055		
Feed per tooth f_{z0} for plunging, central positioning				
Lead angle κ		90°		
Page		F-84		
Material group		f_{z0} (mm)		
	Tool \varnothing or \varnothing range (mm)	63–160	63–250	63–250
	Maximum cutting width SB (mm)	2,0	3,0	4,0
P	Non-alloyed steel ¹	0,08	0,10	0,12
	Low-alloyed steel	0,07	0,09	0,11
	High-alloyed steel and tool steel	0,07	0,09	0,11
	Stainless steel	0,06	0,08	0,09
M	Stainless steel ²	0,06	0,08	0,09
K	Malleable cast iron	0,07	0,09	0,11
	Grey cast iron	0,08	0,10	0,12
	Cast iron with spheroidal graphite	0,07	0,09	0,11
	GGV (CGI)			
N	Aluminium wrought alloys	0,07	0,09	0,11
	Cast aluminium alloys	0,07	0,09	0,11
	Magnesium alloys	0,07	0,09	0,11
	Copper and copper alloys (bronze/brass)	0,07	0,09	0,11
S	Heat-resistant alloys			
	Titanium alloys			
	Tungsten alloys			
	Molybdenum alloys			
H	Hardened steel			
	Hardened cast iron			
O	Thermoplastics			
	Plastic, carbon-fibre reinforced Graphite (technical)			
Insert types				
Correction factor K_{a_e} for feed per tooth depending on the ratio of cutting width a_e to mill diameter D_c	central	1,0	1,0	1,0
	$a_e / D_c = 1/3$	1,5	1,5	1,5
	$1/5$	1,8	1,8	1,8
	$1/10$	2,5	2,5	2,5
	$1/20$	3,3	3,3	3,3
$f_z = f_{z0} \cdot K_{a_e}$	$1/50$	5,8	5,8	5,8

¹ and cast steel

² and austenitic/ferritic

 Please note: The feed per tooth f_z should not exceed 0.6 mm.

Feed determination (starting values) Copy milling cutter (toric)

The specified feed rates are average recommended values.
For special applications, adjustment is recommended.

Mill type		F 2334R		F 4031					
<p>Feed per tooth f_{z0} for $a_e = D_c$ $a_p = a_{p\ max} = L_c$</p>		<p>Xtra-tec®</p>		<p>Xtra-tec®</p>					
Lead angle κ		-		-					
Page		F-88		F-90					
Material group		f_{z0} [mm]		f_{z0} [mm]					
	Tool \emptyset or \emptyset range [mm]	25-40	40-63	12	16	20	25	32	
	Maximum cutting data $a_{p\ max} = L_c$ [mm]	5	6	2-2,5	2,5	3,1	3,5	3,5	
P	Non-alloyed steel ¹	0,17	0,22	0,12	0,14	0,14	0,17	0,17	
	Low-alloyed steel	0,13	0,15	0,08	0,10	0,12	0,14	0,14	
	High-alloyed steel and tool steel	0,13	0,15	0,08	0,10	0,12	0,14	0,14	
	Stainless steel	0,09	0,11	0,06	0,08	0,10	0,12	0,12	
M	Stainless steel ²	0,09	0,11	0,06	0,08	0,10	0,12	0,12	
K	Malleable cast iron	0,17	0,22	0,10	0,12	0,14	0,17	0,17	
	Grey cast iron	0,22	0,28	0,12	0,15	0,17	0,20	0,20	
	Cast iron with spheroidal graphite	0,17	0,22	0,10	0,12	0,14	0,17	0,17	
	GGV (CGI)	0,17	0,22	0,10	0,12	0,14	0,17	0,17	
N	Aluminium wrought alloys			0,07	0,09	0,11	0,13	0,13	
	Cast aluminium alloys			0,07	0,09	0,11	0,13	0,13	
	Magnesium alloys			0,07	0,09	0,11	0,13	0,13	
	Copper and copper alloys (bronze/brass)			0,06	0,08	0,10	0,12	0,12	
S	Heat-resistant alloys	0,09	0,11	0,05	0,06	0,08	0,08	0,08	
	Titanium alloys	0,09	0,11	0,05	0,06	0,08	0,08	0,08	
	Tungsten alloys	0,09	0,11	0,05	0,06	0,08	0,08	0,08	
	Molybdenum alloys	0,09	0,11	0,05	0,06	0,08	0,08	0,08	
H	Hardened steel			0,05	0,06	0,08	0,08	0,08	
	Hardened cast iron			0,06	0,07	0,09	0,09	0,09	
O	Thermoplastics	0,10	0,15	0,10	0,15	0,17	0,20	0,25	
	Plastic, carbon-fibre reinforced								
	Graphite (technical)	0,10	0,12	0,10	0,12	0,15	0,20	0,20	
Insert types		RO . X 10T3 . . .	RO . X 1204 . . .	P8001-D12 . . .	P8001-D16 . . .	P8001-D20 . . .	P8001-D25 . . .	P8001-D32 . . .	
Correction factor Ka_e	$a_e / D_c = 1/1 - 1/2$	1,0	1,0	1,0	1,0	1,0	1,0	1,0	
		1,2	1,2	1,2	1,2	1,2	1,2	1,2	
	For the feed per tooth depending on the ratio of cut width a_e to cutter diameter D_c	1/10	1,5	1,5	1,5	1,5	1,5	1,5	1,5
		1/20	1,8	1,8	1,8	1,8	1,8	1,8	1,8
Correction factor Ka_p	$a_p =$	1	1,5	1,6					
		2	1,2	1,3					
		3	1,0	1,1					
		4	1,0	1,0					
		6							
$f_z = f_{z0} \cdot Ka_e \cdot Ka_p$	8								
	10								

¹ and cast steel
² and austenitic/ferritic

Feed determination (starting values) Circular interpolation milling cutter

The specified feed rates are average recommended values.
For special applications, adjustment is recommended.

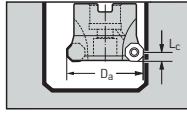
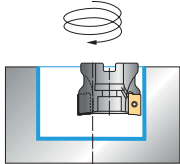
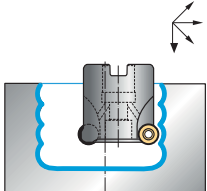
Mill type		F 2010 / F 4042	F 2334R	
Feed per tooth f_{z0} for $a_e = D_c$ $a_p = a_{p \max} = L_c$ 		 <p>Xtra-tec®</p>		
Lead angle κ		90°	–	
Page		F-68	F-88	
Material group		f_{z0} [mm]	f_{z0} [mm]	
		F 2010 F 4042		
Tool \varnothing or \varnothing range [mm]		40–160	25–40	40–63
Maximum cutting data $a_{p \max} = L_c$ [mm]		15	5	6
P	Non-alloyed steel ¹	0,22	0,17	0,22
	Low-alloyed steel	0,16	0,13	0,15
	High-alloyed steel and tool steel	0,16	0,13	0,15
	Stainless steel	0,13	0,09	0,11
M	Stainless steel ²	0,10	0,09	0,11
K	Malleable cast iron	0,22	0,17	0,22
	Grey cast iron	0,27	0,22	0,28
	Cast iron with spheroidal graphite	0,22	0,17	0,22
	GGV (CGI)	0,22	0,17	0,22
N	Aluminium wrought alloys	0,13		
	Cast aluminium alloys	0,13		
	Magnesium alloys	0,13		
	Copper and copper alloys (bronze/brass)	0,13		
S	Heat-resistant alloys	0,13	0,09	0,11
	Titanium alloys	0,13	0,09	0,11
	Tungsten alloys	0,13	0,09	0,11
	Molybdenum alloys	0,13	0,09	0,11
H	Hardened steel			
	Hardened cast iron			
O	Thermoplastics	0,20	0,10	0,15
	Plastic, carbon-fibre reinforced			
	Graphite (technical)	0,15	0,10	0,12
Insert types		AD . T 1606 . .	RO . X 10T3 . .	RO . X 1204 . .
Correction factor K_{a_e}	$a_e / D_c = 1/1 - 1/2$	1,0	1,0	1,0
For the feed per tooth depending on the ratio of cut width a_e to cutter diameter D_c	$1/5$	1,1	1,2	1,2
	$1/10$	1,2	1,5	1,5
	$1/20$	1,3	1,8	1,8
	$1/50$		2,0	2,0
Correction factor K	$1 < (L : D_c) = \leq 2$			
	$2 < (L : D_c) = \leq 4$			
$f_z = f_{z0} \cdot K_{a_e} \cdot K$	$4 < (L : D_c) = \leq 6$			

¹ and cast steel

² and austenitic/ferritic

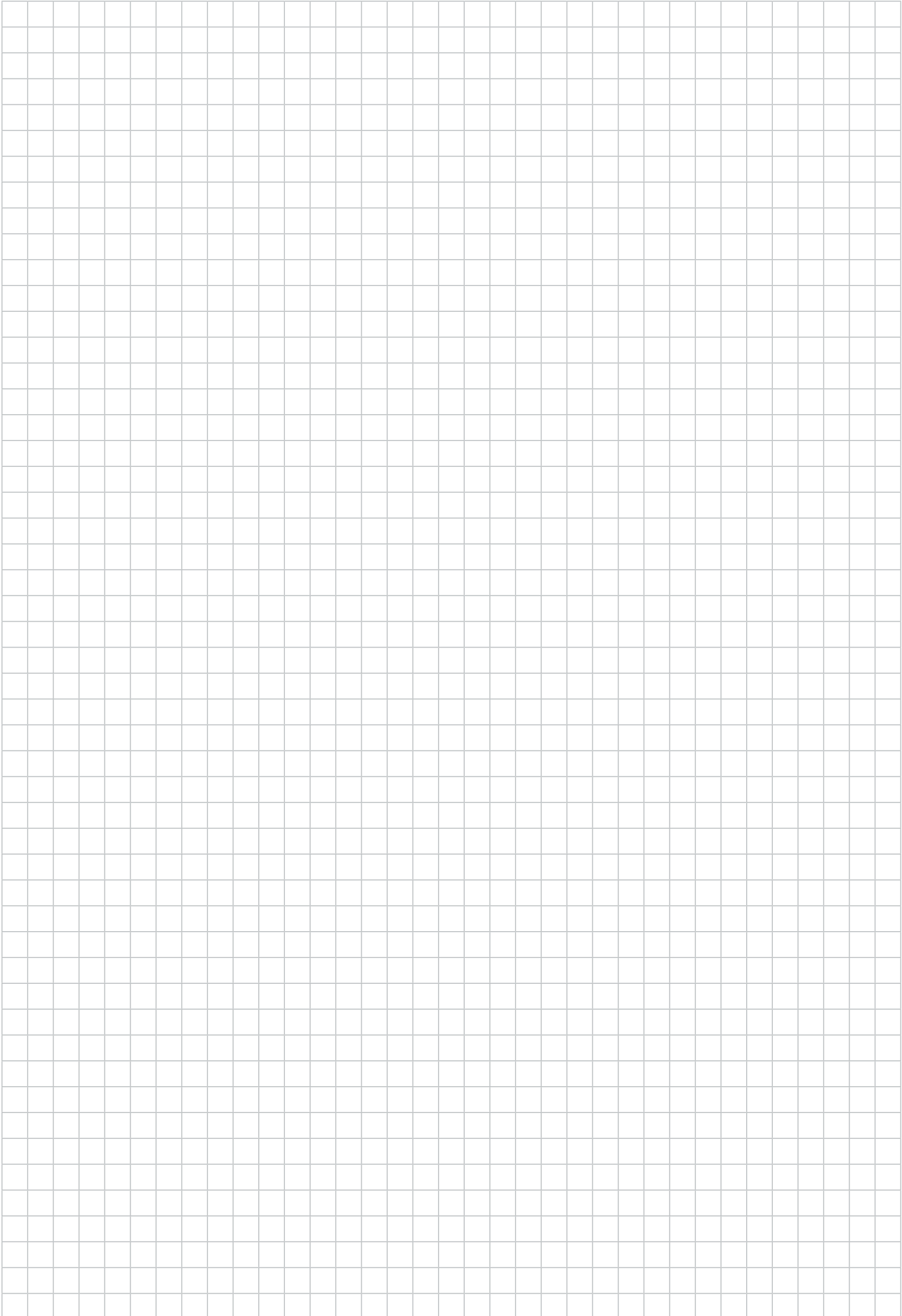

Cutting tool material application tables – Milling

Coated carbide																				
Walter grade designation	Standard designation	Workpiece material group							Application range						Coating process	Coating composition	Indexable insert example			
		P	M	K	N	S	H	O	01	05	10	15	20	25				30	35	40
		Steel	Stainless steel	Cast iron	NF metals	Difficult-to-machine materials	Hard materials	Other												
WKP 35 S	HC – P 35	●●																	CVD TiCN + Al ₂ O ₃ (+TiCN)	
	HC – K 35			●●																
WKP 25S	HC – P 25	●●																	CVD TiCN + Al ₂ O ₃ (+TiCN)	
	HC – K 25			●●																
WKP 35	HC – P 35	●●																	CVD TiCN + Al ₂ O ₃ (+TiN)	
	HC – K 35			●●																
WKP 25	HC – P 25	●●																	CVD TiCN + Al ₂ O ₃ (+TiN)	
	HC – K 25			●●																
WAK 15	HC – K 15			●●															CVD TiCN + Al ₂ O ₃ (+TiN)	
WSP 45S	HC – S 45							●●											PVD TiAlN + Al ₂ O ₃ (Al)	
	HC – P 45	●●																		
	HC – M 45		●●																	
WSM 35S	HC – S 35							●●											PVD TiAlN + Al ₂ O ₃ (Al)	
	HC – M 35		●●																	
WSP 45	HC – S 45							●●											PVD TiAlN + Al ₂ O ₃ (ZrCN)	
	HC – P 45	●●																		
	HC – M 45		●●																	
WSM 35	HC – S 35							●●											PVD TiAlN + Al ₂ O ₃ (ZrCN)	
	HC – M 35		●●																	
WKK 25	HC – K 25			●●															PVD TiAlN + Al ₂ O ₃ (ZrCN)	
WSP 46	HC – S 45							●●											PVD TiAlN + Al ₂ O ₃	
	HC – P 45	●●																		
	HC – M 45		●●																	
WSM 36	HC – S 35							●●											PVD TiAlN + Al ₂ O ₃	
	HC – M 35		●●																	
WHH 15	HC – H 15							●●											PVD TiAlN	
	HC – P 15	●																		
	HC – K 15			●																
WXN 15	HC – N 15							●●											PVD TiCNplus	
WXM 15	HC – P 15	●●																	PVD Multilayer TiAlN / TiN	
	HC – M 15		●																	
	HC – K 15			●																

BH = CBN with high CBN content
 CN = Silicon nitride Si₃N₄
 DP = Polycrystalline diamond
 HC = Coated carbide
 HF = Uncoated fine-grained carbide
 HW = Uncoated carbide

●● Primary application
 ● Other application



Cutting tool material application tables – Milling

Uncoated carbide grades, cutting ceramics, CBN and PCD																									
Walter grade designation	Standard designation	Workpiece material group						Application range							Coating process	Coating composition	Indexable insert example								
		P	M	K	N	S	H	O	01	05	10	15	20	25				30	35	40	45				
		Steel	Stainless steel	Cast iron	NF metals	Difficult-to-machine cut materials	Hard materials	Other																	
WK 10	HW – N 10				●●																				
WMG 40	HF – N 35				●●																				
WCB 80	BH – K 05			●●																					
	BH – H 15						●																		
WCB 50	BH – H 10						●●																		
	BH – K 10			●																					
WSN 10	CN – K 20			●●																					
WCD 10	DP – N 10				●●																				

BH = CBN with high CBN content
 CN = Silicon nitride Si₃N₄
 DP = Polycrystalline diamond
 HC = Coated carbide
 HF = Uncoated fine-grained carbide
 HW = Uncoated carbide



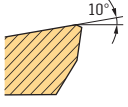
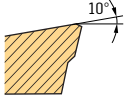
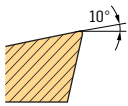
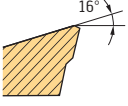
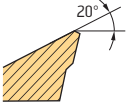
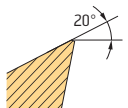
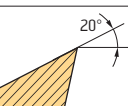

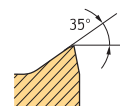
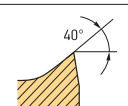
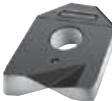
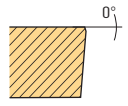
●● Primary application
 ● Other application

Geometry overview of milling indexable inserts

Tool families/insert geometry		Cut Main cutting edge	Workpiece material group							Suitable tool families
Geometry example	Remarks on field of applications		P Steel	M Stainless steel	K Cast iron	N NF metals	S Difficult-to-machine materials	H Hard materials	O Other	
 AD . T . .	D51 – The quiet one → antivibration geometry → for tools with long projection lengths		●●	●	●●	●	●			F2010 F 4042 F 4042R F 4038 F 4138 F 4238 F 4338
	D56 – The stable one → for unfavourable machining conditions → maximum cutting edge stability → high feeds		●●	●	●●	●	●			
	D67 – The powerful one → high cutting edge stability → for machining high-alloy and high-tensile steels and Ni-based alloys → high level of accuracy		●●	●●	●	●	●●			
	F56 – The universal one → for medium machining conditions → universal application for most materials		●●	●●	●●	●	●●			
	G56 – The easy-cutting one → for good machining conditions → low cutting forces → medium feed rates		●●	●●	●●	●	●●			
	G77 – The special one → for machining titanium materials → low cutting forces → high level of accuracy		●	●●	●	●	●●			
	G88 – The sharp one → for machining aluminium → low cutting forces → sharp cutting edges					●●			●	
 LNHU . .	L55T – The universal one → for medium machining conditions → universal application for most materials		●●	●●	●●	●	●●			F 5041 F 5141 F 5241 F 5138
	L85T – The sharp one → for machining aluminium → low cutting forces → sharp cutting edges					●●			●	
 P 8001 . .	A57 – The universal one → for medium machining conditions → universal application for most materials		●●	●	●●	●		●●		F 4031

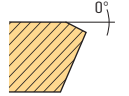
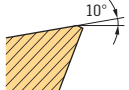
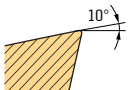
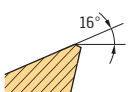
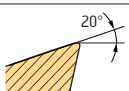
●● Primary application
 ● Other application

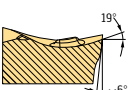
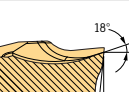
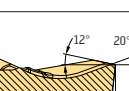
Geometry overview of milling indexable inserts

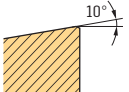
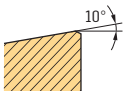
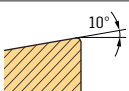
Tool families/insert geometry		Cut Main cutting edge	Workpiece material group							Suitable tool families
Geometry example	Remarks on field of applications		P Steel	M Stainless steel	K Cast iron	N NF metals	S Difficult-to-machine materials	H Hard materials	O Other	
 RO . X . .	A27 – The stable one → for unfavourable machining conditions → maximum cutting edge stability → high feeds		••		••					F 2334R
	D57 – The universal one → for medium machining conditions → universal application for most materials		••	••	••		••			
	D67 – The powerful one → high cutting edge stability → for machining high-alloy and high-tensile steels and Ni-based alloys, e.g. Inconel → high level of accuracy		••	••	•		••			
	F67 – The easy-cutting one → especially for blade machining → low cutting forces		••	••	•		••			
	G77 – The special one → for machining titanium materials → low cutting forces → high level of accuracy		•	••			••			
 SX . . .	CF6 – The easy-cutting one → good machining conditions → low feeds → for machining non-ferrous metals → low cutting force		••	••		••	••		•	F 5055
	CF5 – The universal one → universal application for most materials → light to moderate feeds		••	••	•	••	••		•	
	CE4 – The stable one → moderate to high feeds → excellent chip constriction → stable cutting edge		••	•	••	•	•		•	
 XNHF . .	D27 – The stable one → for unfavourable machining conditions → maximum cutting edge stability → high feeds		•		••					F 4045
	D57 – The universal one → for medium machining conditions → universal application		•		••					
	D67 – The easy-cutting one → for good machining conditions → low cutting forces → medium feed rates		•		••					

•• Primary application
 • Other application

Assembly instructions for Walter BLAXX slitting cutter F 5055

Slitting cutters F 5055 must always be used together with two drive collars or retaining discs (order separately):

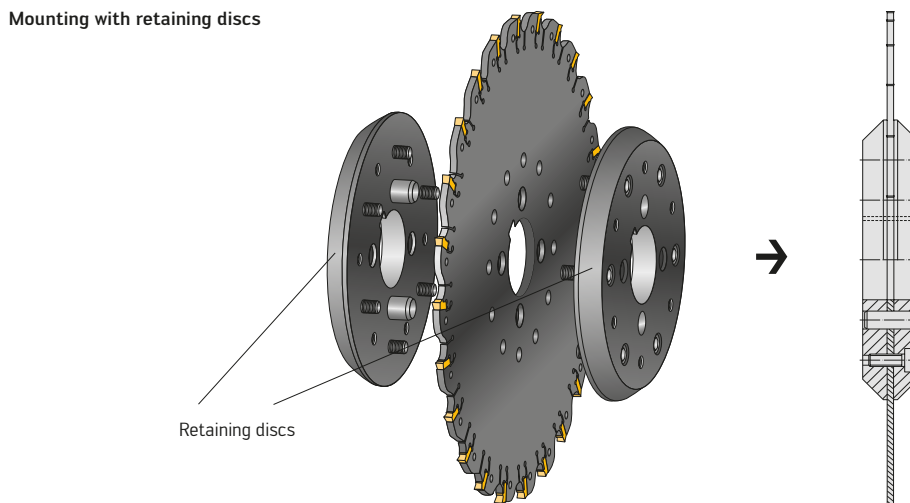
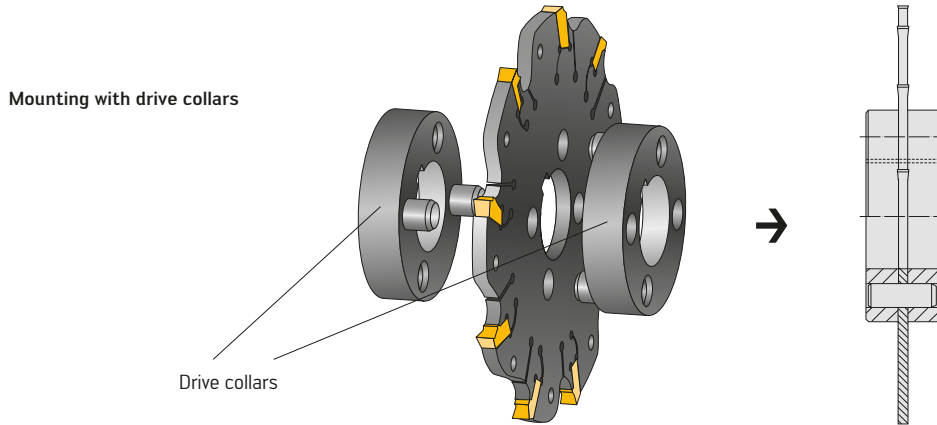

Please note:
When using retaining discs, check the measurement a_b (see page F-84).

Use of the mounting wrench:

Mounting the insert

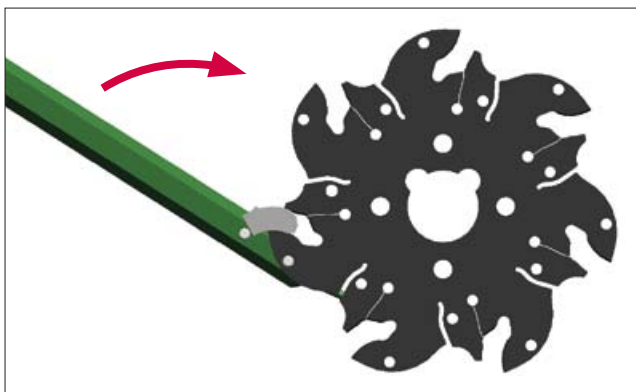

Removing the insert

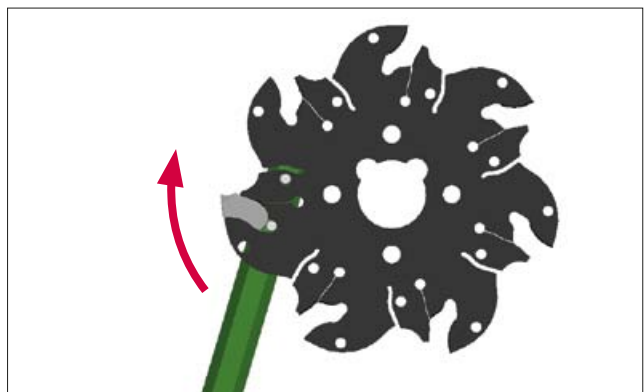

Note:
Only use mounting wrench FS 1494. When mounting the insert, always position the wrench in the bore hole below the insert.

Assembly instructions for F 4050

Fitting the adjustment unit

Screw the compound screw ① approx. 1 to 2 threads deep into the adjusting key ②.
 Then fit the adjusting key ② in the body.
 Screw in as far as the stop.
 If it is stiff to fit, the key must be held in position in the cartridge mounting bore ③ using a pin.

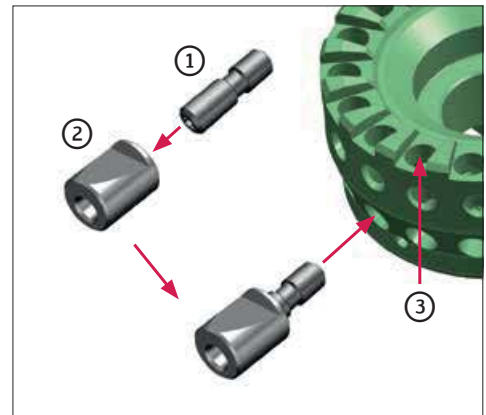

Fitting the cartridges

Insert the cartridge ④ into the cartridge mounting bore from above ③.
 Then reset the clamping wedge ② as far as the outer stop, while pressing the cartridge ④ downwards.
 Now fit the cartridge clamping screw ⑥ with the Schnorr washer ⑤.

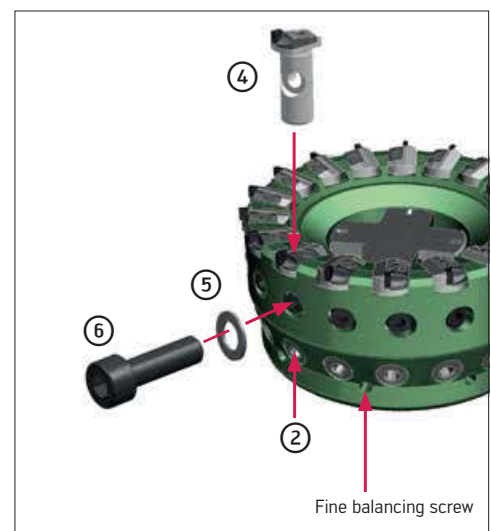

Setting instructions for F 4050

Requirements

You can set the runout using optical or touch-sensitive measuring devices.
 For touch-sensitive measuring devices, a probe fitted with a flattened shoe and having a low measuring force should be used. When using optical measuring devices, check for dirt deposits on the cutting edge. All cartridge clamping screws ⑥ must be tightened to a torque of 3 Nm, and all adjusting keys ② must be reset to the outer stop.

Setting the runout

The highest cutting edge is the starting point for setting the runout. This should be set to the nominal installation height. All other cutting edges must be set to this height. The cutting edge height can be adjusted using the adjusting key ②. If the cutting edge has been set too high, the cartridge clamping screw ⑥ must be loosened, the adjusting key ② must be turned back and the cartridge must be pressed downwards. After the cartridge clamping screw ⑥ has been re-tightened, the cutting edge can be set.

Once all cartridges are set to the same height, all cartridge clamping screws ⑥ must be tightened to a torque of 9 Nm. The clamping wedges ② must be released and then positioned only lightly. Then check the runout again (runout should be within 5 µm).

When using a wiper finishing cartridge, this should protrude 0.03-0.05 mm axially in comparison to roughing cartridges.



Notes on high-speed cutting

- Maximum permissible RPM:
The limiting values shown in the tables should not be exceeded. Otherwise correct operation and/or reliability is not guaranteed.
- Only use original Walter inserts and assembly parts (screws etc.). Recommendation: New screws should be fitted after having replaced the inserts five times at the latest.
- Observe the torques specified in the catalogue.
- Balancing:
Balancing in two steps is required when milling at fast speeds (> 6,000 rpm) or at circumferential speeds of > 1,000 m/min.:
 - Basic balancing of the tool body including indexable inserts (can be carried out by Walter if required). In this case, tool adaptors that have been balanced separately beforehand must be used.
 - Fine balancing of the tool when fully mounted on the adaptor. The fine balancing operation is strongly recommended as even the smallest eccentricity can seriously affect the balance status.
- Short projection lengths reduce concentricity faults or an imbalance, as well as increase spindle life. The specified speeds apply to the use of tools without additional extensions.
- Safety guards:
Appropriate safety guards or machine encapsulations must be used to securely collect particles which spin off, such as chips or cutting edges that are broken as a result of collisions.
- Damaged tools:
The operating speed must be specified for the repair of HSC Tools. Repairs on Walter tools for HSC machining operations must only be carried out by Walter.
- Use of standards:
Walter recommends using the balancing standard DIN 69888, which describes the balancing of tools and the requirements in the chip removal area. DIN 69888 is tailored to the needs of the cutting area, and describes the tool balancing requirements in a practical way. DIN ISO 1940, which was previously often used, describes balancing for all areas of mechanical engineering. The requirements when working at circumferential speeds of >1,000 m/min are described in DIN ISO 15641.

Walter milling cutters

Tool	Safety-related parts	in relation to	n_{max} [1/min] with D															
			Ø 10	Ø 16	Ø 20	Ø 25	Ø 32	Ø 40	Ø 50	Ø 63	Ø 80	Ø 100	Ø 125	Ø 160	Ø 200	Ø 250	Ø 315	
F 2010	all cartridges											6.700	6.000	5.400	4.700	4.200	3.800	3.350
F 2139 ¹	P 32 ..	D _c		40.000*	40.000*	40.000*	40.000*											
F 2231 Form A	RD .. 0501M0	D _a	40.000*															
	RD .. 0803M0	D _a		40.000*														
	RD .. 10T3M0	D _a			40.000*													
	RD .. 1204M0	D _a				33.300												
	RD .. 1605M0	D _a					27.200											
	RD .. 2006M0	D _a						24.300										
F 2233	SD .. 09T3 ..	D _c			40.000*	39.600	35.000	31.300	28.000	25.000	22.100	19.800						
	SP .. 1204 ..	D _c				40.000	40.000	37.600	33.600	30.000	26.600	23.800	21.200	17.000				
F 2234	RD .. 0501M0	D _a		40.000*	40.000*	40.000*												
	RD .. 07T1M0	D _a		40.000*	40.000*	40.000*	35.000	31.300										
	RD .. 0803M0	D _a		40.000*	40.000*	40.000*												
	RD .. 10T3M0	D _a			40.000*	40.000*	37.100											
	RD .. 1204M0	D _a				33.300	29.400	26.300	23.500	21.000	18.600	16.600						
	RD .. 1605M0	D _a							21.700	19.400	17.200	15.300	13.700					
	RD .. 2006M0	D _a								19.400	17.200	15.300	13.700	12.100				
F 2238	LP .. 0703 ..	D _c			40.000*	40.000*	39.900	35.700	31.900									
	LP .. 15T3 ..	D _c						21.900	19.600									
	LP .. 1504 ..	D _c							18.500	16.500	14.600	13.000	11.700					
	AP .. 2004 ..	D _c							17.300	15.500	13.700							
F 2241	SP .. 0603 ..	D _c		40.000*	40.000*	40.000*	38.500	37.600	33.600									
	SP .. 09T3 ..	D _c				40.000*	39.900	35.700	31.900	28.500	25.200	22.600	20.200	17.000				
	SP .. 1204 ..	D _c					30.800	27.600	24.600	22.000	19.500	17.400	15.600	13.800				
F 2250	all cartridges	D _c							22.800	20.400	18.100	16.100	14.400	12.800	11.400	10.200		
	without cartridges SP .. 1204 ..	D _c								22.000	19.500	17.400						
F 2330	P 2633 ..	D _c			35.400	31.700	28.000	25.000	22.400	20.000	17.700							

¹ The specified speed of 40,000 rpm refers to the entire tool diameter range of 8-32 mm.

* Higher speeds than 40,000 1/min are possible under favourable conditions and short projection lengths upon consultation with Walter.

Notes on high-speed cutting (continued)

Walter milling cutters

Tool	Safety-related parts	in relation to	n _{max} [1/min] with D															
			Ø 10	Ø 16	Ø 20	Ø 25	Ø 32	Ø 40	Ø 50	Ø 63	Ø 80	Ø 100	Ø 125	Ø 160	Ø 200	Ø 250	Ø 315	
F 2334	RO . . 0803M0	D _a				40.000*	37.100											
	RO . . 10T3M0	D _a					37.100	33.200	29.700	26.500	23.500							
	RO . . 1204M0	D _a						28.200	25.200	22.500	19.900							
	RO . . 1605M0	D _a								23.000	20.500	18.100	16.200	14.500				
	RO . . 2006M0	D _a									19.400	17.200	15.300	13.700	12.100			
F 2334R	RO . X 10T3	D _a				40.000*	37.100	33.200										
	RO . X 1204	D _a						28.200	25.200	22.500								
F 3040	ZD . . 1504 . .	D _c				36.500	32.200	28.800	25.800	23.000								
	ZD . . 2005 . .	D _c					32.200	28.800	25.800	23.000								
F 4030	P 23696-1.0	D _a				34.900	30.800	27.600	24.600	22.000								
	P 23696-1.0	D _a							20.200	18.000	15.900	14.200						
F 4031	P 8001	D _c		40.000*	40.000*	40.000*	40.000*											
F 4033	SN . X 1205 . .	D _c						20.000	17.900	16.000	14.200	12.700	11.300	10.000				
	SN . X 1606 . .	D _c						21.000	18.800	16.800	15.000	13.300	11.900	10.600	9.400	8.400	7.500	
F 4038	AD . . 0803 . .	D _c			40.000*	38.000	33.600											
F 4138	AD . . 1204 . .	D _c					25.100	22.400	20.000	17.900	15.800							
F 4238	AD . . 1606 . .	D _c						15.800	14.100	12.600	11.100							
F 4338	AD . . 1807 . .	D _c								12.600	11.100	10.000	8.900					
F 4041	LN GX 1307 . .	D _c					14.000	12.500	11.200	10.000	8.800	7.900	7.000	6.200	5.600	5.000		
F 4042 F 4042R	AD . . 0803 . .	D _c		40.000*	40.000*	38.000	33.600	30.100	26.900									
	AD . . 10T3 . .	D _c		39.600	35.400	31.700	28.000	25.000	22.400	20.000								
	AD . . 1204 . .	D _c				28.400	25.100	22.400	20.000	17.900	15.800							
	AD . . 1606 . .	D _c						15.800	14.100	12.600	11.100	10.000	8.900	7.900				
	AD . . 1807 . .	D _c					17.600	15.800	14.100	12.600	11.100	10.000	8.900	7.900				
F 4045	XN . F 0705 . .	D _c								10.000	8.800	7.900	7.000	6.200	5.600			
	XN . F 0906 . .	D _c									5.700	5.100	4.600	4.000	3.600			
F 4047	SN . X 1205 . .	D _c						18.800	16.800	14.000	13.300	11.900	10.600	9.400	8.400			
F 4048	SN . X 1205 . .	D _c						18.800	16.800	14.000	13.300	11.900	10.600	9.400	8.400			
F 4050		D _c									20.000	17.800	16.000	14.100	12.600			
F 4080	OD . . 0504 . .	D _a					29.400	26.300	23.500	21.000	18.600	16.600	14.900	13.100				
	OD . . 0605 . .	D _a							19.600	17.500	15.500	13.800	12.400	10.900	9.800			
F 4081	OD . . 0504 . .	D _a					29.400	26.300	23.500	21.000	18.600	16.600						
	OD . . 0605 . .	D _a							19.600	17.500	15.500	13.800						
F 4053	LN . X 0702 . .	D _c									21.200	19.000	17.000	15.000				
F 4153	LN . U 0803 . .	D _c									11.000	9.900	8.800	7.800				
	LN . U 0804 . .	D _c									9.300	8.300	7.400	6.500				
	LN . U 1005 . .	D _c									13.700	12.300	11.000	9.700				
F 4253	LN . U 0804 . .	D _c											17.000	15.000				
	LN . U 1005 . .	D _c											16.100	14.200				
	LN . U 1206 . .	D _c											12.400	10.900	9.800	8.700		
	LN . U 1608 . .	D _c												7.800	7.000	6.200	5.500	
F 5041	LN . . 0904 . .	D _c				39.600	35.000	31.300	28.000	25.000								
F 5141	LN . . 1306 . .	D _c						22.500	20.200	18.000	15.900	14.200	12.700					
F 5241	LN . . 1607 . .	D _c							20.200	18.000	15.900	14.200	12.700	11.200				
F 5138	LN HU 1306 . .	D _c						22.500	20.200	18.000	15.900							
F 5055	SX . .	D _c									5.100	4.000	3.200	2.600	2.000	1.600	1.300	

* Higher speeds than 40,000 1/min are possible under favourable conditions and short projection lengths upon consultation with Walter.

Application information for shoulder milling cutter F 4042

Angular plunging and circular interpolating into solid material

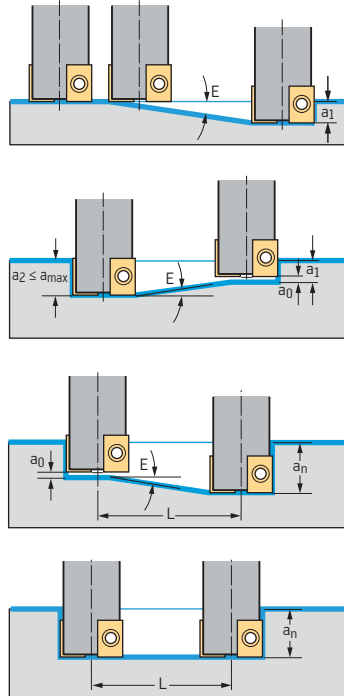

Plunging with shoulder milling cutter

Milling cutter \varnothing D_c [mm]	Plunging angle E_{max} [°]	AD .. 160608 $a_{p\ max} = 15\ mm$		
		$D_0\ min$ [mm]	$D_0\ max$ [mm]	a_0 [mm]
25	8,5	32	50	1,7
32	7,5	46	64	3,2
36	7,0	54	72	3,2
40	5,9	62	80	2,9
44	4,5	70	88	2,9
50	3,9	82	100	2,6
54	2,7	90	108	2,6
63	2,6	108	126	2,3
66	1,8	114	132	2,3
80	1,9	142	160	2,3
84	1,6	150	168	2,3
100	1,5	182	200	2,3
125	1,2	232	250	2,3
160	0,9	302	320	2,3

Circular interpolation milling

Max. axial feed per tool revolution ("thread pitch") f [mm]

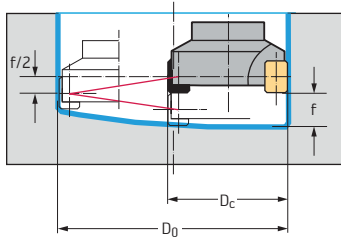

Machined hole \varnothing D_0 [mm]	AD .. 160608 D_c [mm]														
	25	32	36	40	44	50	54	63	66	80	84	100	125	160	
32	3,4														
40	7,2														
50	11,9	7,6													
60	15,0	11,7	9,4												
80	15,0	15,0	15,0	13,1	9,1										
100	15,0	15,0	15,0	15,0	14,0	10,8	7,0								
120	15,0	15,0	15,0	15,0	15,0	15,0	9,9	8,1	5,5						
150	15,0	15,0	15,0	15,0	15,0	15,0	14,4	12,4	8,4	7,5	5,9				
180	15,0	15,0	15,0	15,0	15,0	15,0	15,0	15,0	11,4	10,7	8,6				
200	15,0	15,0	15,0	15,0	15,0	15,0	15,0	15,0	13,4	12,8	10,3	8,2			
250	15,0	15,0	15,0	15,0	15,0	15,0	15,0	15,0	15,0	15,0	14,7	12,3	8,0		
300	15,0	15,0	15,0	15,0	15,0	15,0	15,0	15,0	15,0	15,0	15,0	15,0	11,2		
350	15,0	15,0	15,0	15,0	15,0	15,0	15,0	15,0	15,0	15,0	15,0	15,0	15,0	4,4	9,3
400	15,0	15,0	15,0	15,0	15,0	15,0	15,0	15,0	15,0	15,0	15,0	15,0	15,0	15,0	11,7
450	15,0	15,0	15,0	15,0	15,0	15,0	15,0	15,0	15,0	15,0	15,0	15,0	15,0	15,0	14,2
500	15,0	15,0	15,0	15,0	15,0	15,0	15,0	15,0	15,0	15,0	15,0	15,0	15,0	15,0	15,0

Application information for round insert cutter F 2334R

Face milling

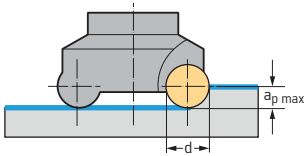

Max. milling depth $a_{p \max}$ [mm]

$a_{p \max}$ [mm]	Indexable insert diameter d [mm]			
	d = 10	d = 12		
	5,0	6,0		

Circular interpolation milling of a hole into solid material

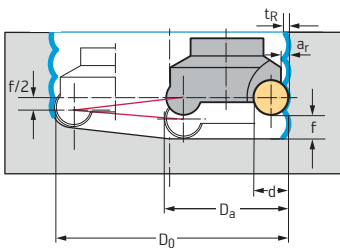

Range of diameters for milling a hole in one pass [mm]

D_a [mm]	Indexable insert diameter d [mm]			
	d = 10		d = 12	
	$D_{0 \min}$ [mm]	$D_{0 \max}$ [mm]	$D_{0 \min}$ [mm]	$D_{0 \max}$ [mm]
25	31	50		
32	45	64		
40	61	80	57,4	80
50			77,2	100
52			81,2	104
63			103,2	26

Groove depth on the hole wall t_R [mm]

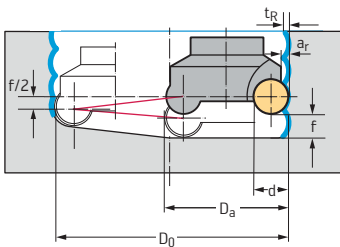

Axial feed rate per revolution f [mm]	Indexable insert diameter d [mm]			
	d = 10	d = 12		
1	0,025	0,02		
2	0,010	0,08		
3	0,230	0,19		
4	0,417	0,34		
5	0,670	0,54		
6	(1,000)	0,80		
7	(1,429)	(1,12)		
8		(1,53)		
$a_R \max$	1,5	2,0		

The values in brackets only apply to short bores.

Application information for round insert cutter F 2334R (continued)

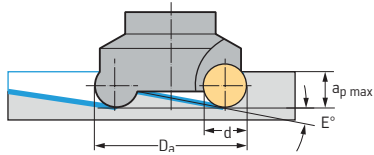
Inclined plunging
**F 2334R:
Maximum feed angle E [°]**

D _a [mm]	Indexable insert diameter d [mm]		
	d = 10	d = 12	
25	14,6		
32	8,6		
40	5,8	7,9	
50	4,0	5,4	
52	3,9	5,3	
63	3,0	3,4	
a _{p max} [mm]	8,8	10,5	

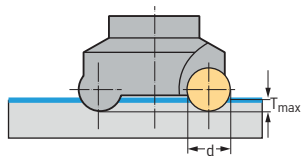
Vertical plunging
**F 2334R:
Max. plunging depth T_{max} [mm]**

T _{max} [mm]	Indexable insert diameter d [mm]		
	d = 10	d = 12	
	2,6	3,1	

Application information for torus cutter F 4031

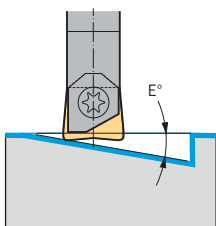
Inclined plunging

D _c [mm]	Maximum feed angle E [°]		
Ø 12	8		
Ø 16	8		
Ø 20	8		
Ø 25	8		
Ø 32	8		





CONTENTS

Adaptors and clamping units

	Page
	G-2
	G-2
Walter Capto™ clamping units and adaptors	G-10
Boring bar adaptors	G-17
Walter NC Tools Masters, intermediate elements and adaptors	G-18
Adaptors for ScrewFit front pieces	G-19
Adaptors for ConeFit™ mill heads	G-24
Adaptors for honeycomb milling cutters	G-27
HSK adaptors	G-28
SK adaptors	G-29
	G-33
	G-35
	G-37
Technical Information	G-41

Product range overview of Walter Capto™ clamping units and adaptors

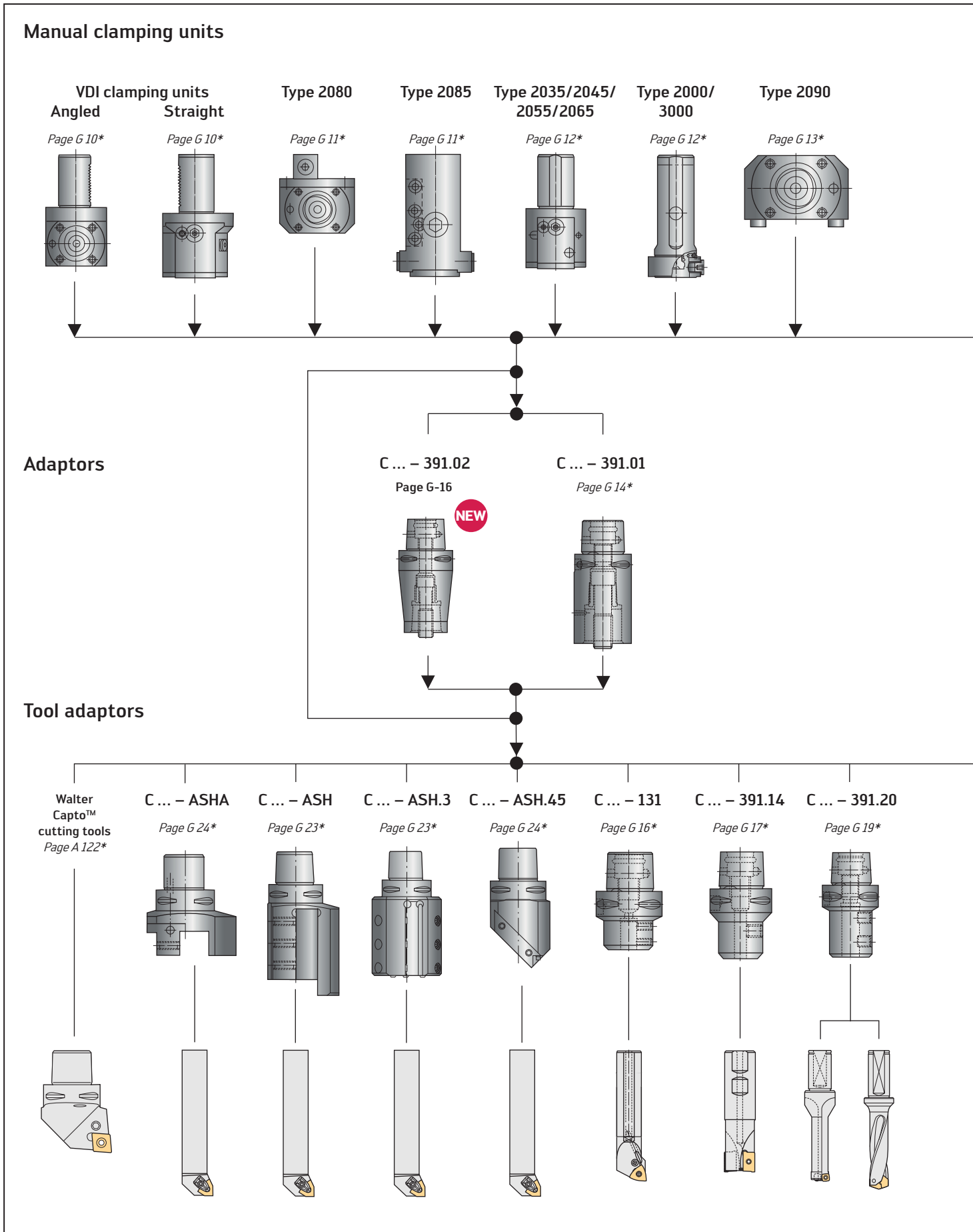

* The pages indicated in italics refer to the Walter General catalogue 2012.

HSK Capto
C...390.410

Page G 26*

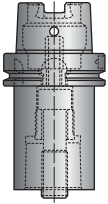

SK Capto
C...390.140

Page G-10

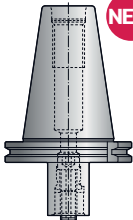

MAS BT Capto
C...390.55/58

Page G-11

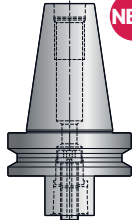

SK** Capto
C...390.540

Page G-12

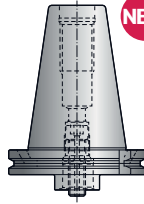

MAS BT** Capto
C...390.555/558

Page G-13

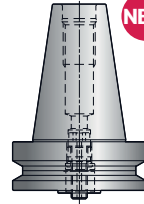

Driven
Walter Capto™
toolholders
on request



Walter Capto™
special clamping
units
on request



C... - 391.27

Page G-14

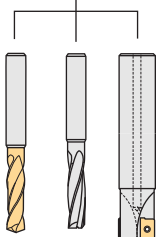
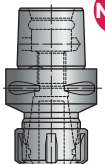

C... - 391.60

Page G 22*

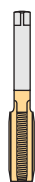
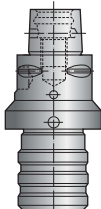

AK 155.8.C

Page G 25*

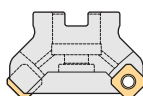
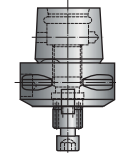

AK 580.C

Page G 80*

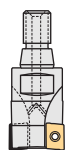
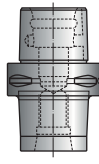

AK 681

Page G 86*

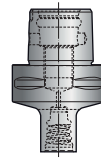

A 100 M.8

Page G 47*

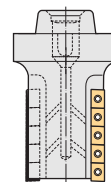
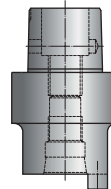

Walter Capto™
hydro-expansion
chucks
on request

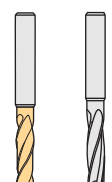

Product range overview of Walter NC Tools

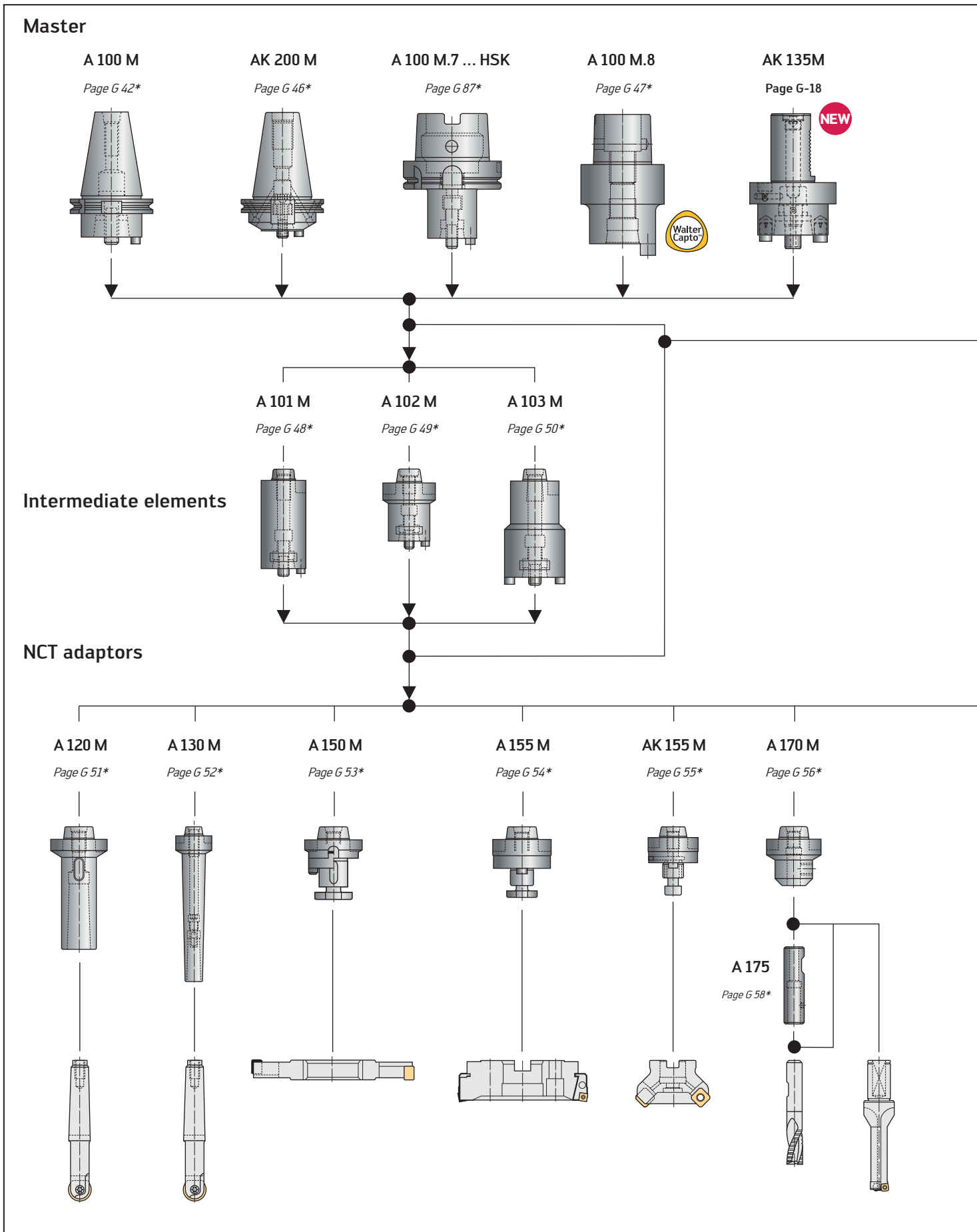

AK 520

*Page G 69**

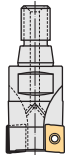
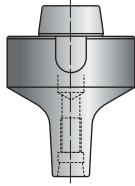

For the ScrewFit system, see page C 42 or F 52 in the Walter General catalogue 2012.

A 201 M

*Page G 59**



AK 300 M

*Page G 61**

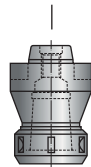

A 305
*Page G 63**

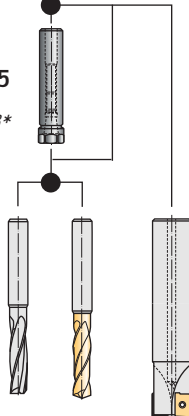

A 320 M

*Page G 64**



**A 330/
A 331**
*Page G 98**

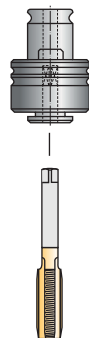

A 340 M

*Page G 65**

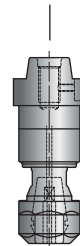

**Tools
with NCT
interface**

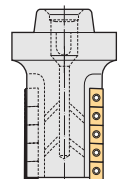

Product range overview of adaptors for ConeFit™

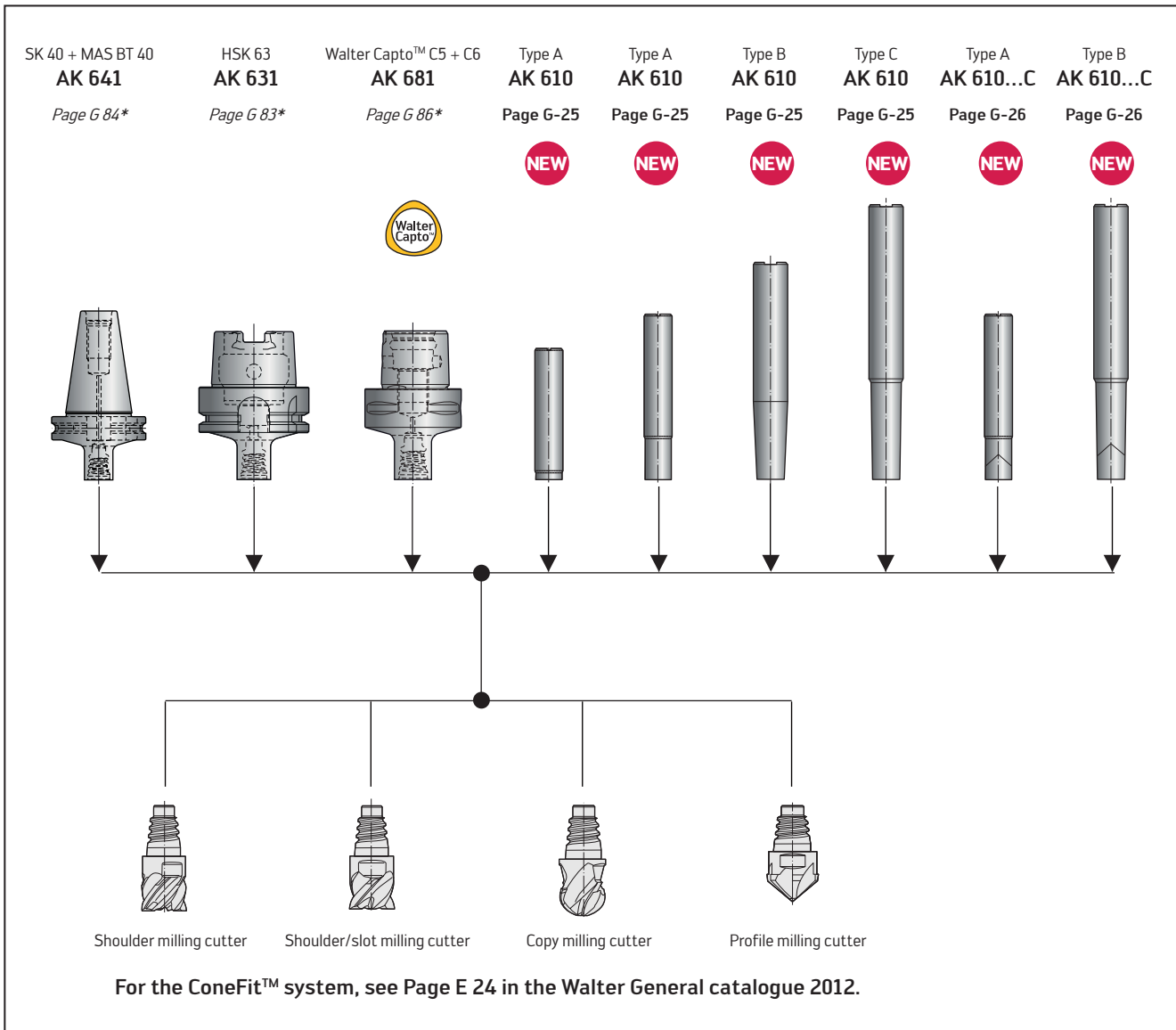

** The pages indicated in italics refer to the Walter General catalogue 2012.*

Product range overview of adaptors for ScrewFit

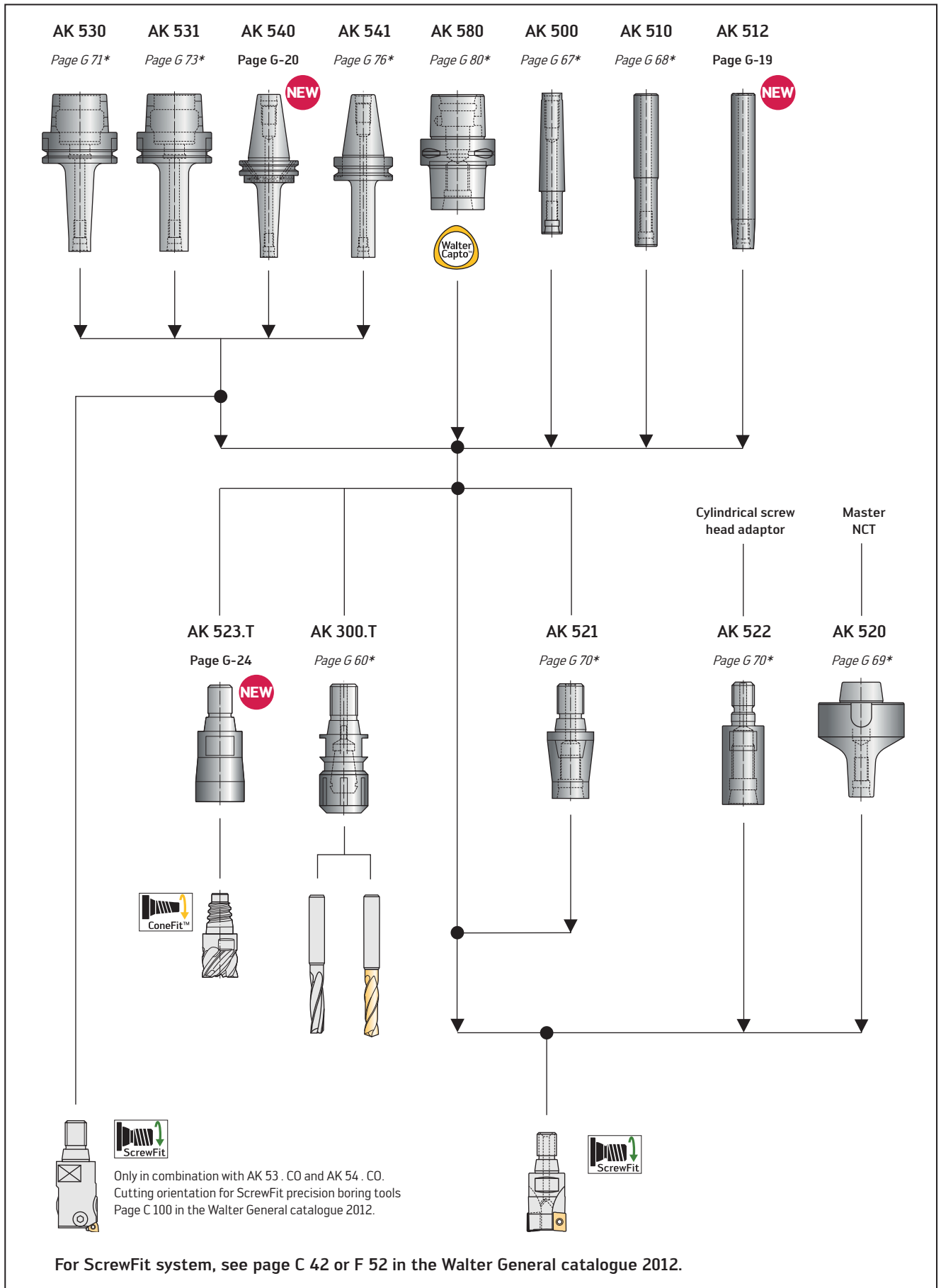

For ScrewFit system, see page C 42 or F 52 in the Walter General catalogue 2012.

Product range overview of HSK adaptors

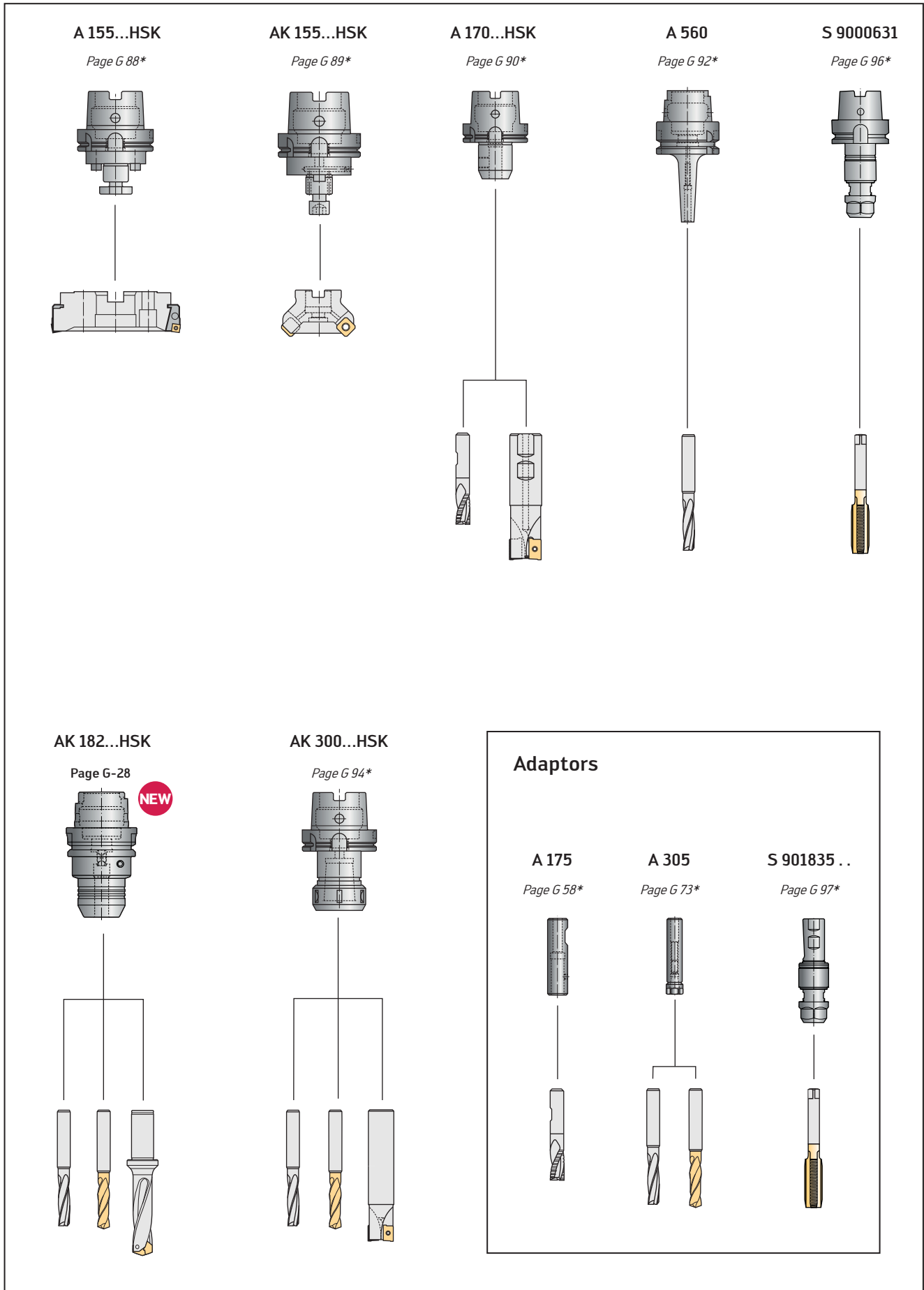

Product range overview of SK adaptors

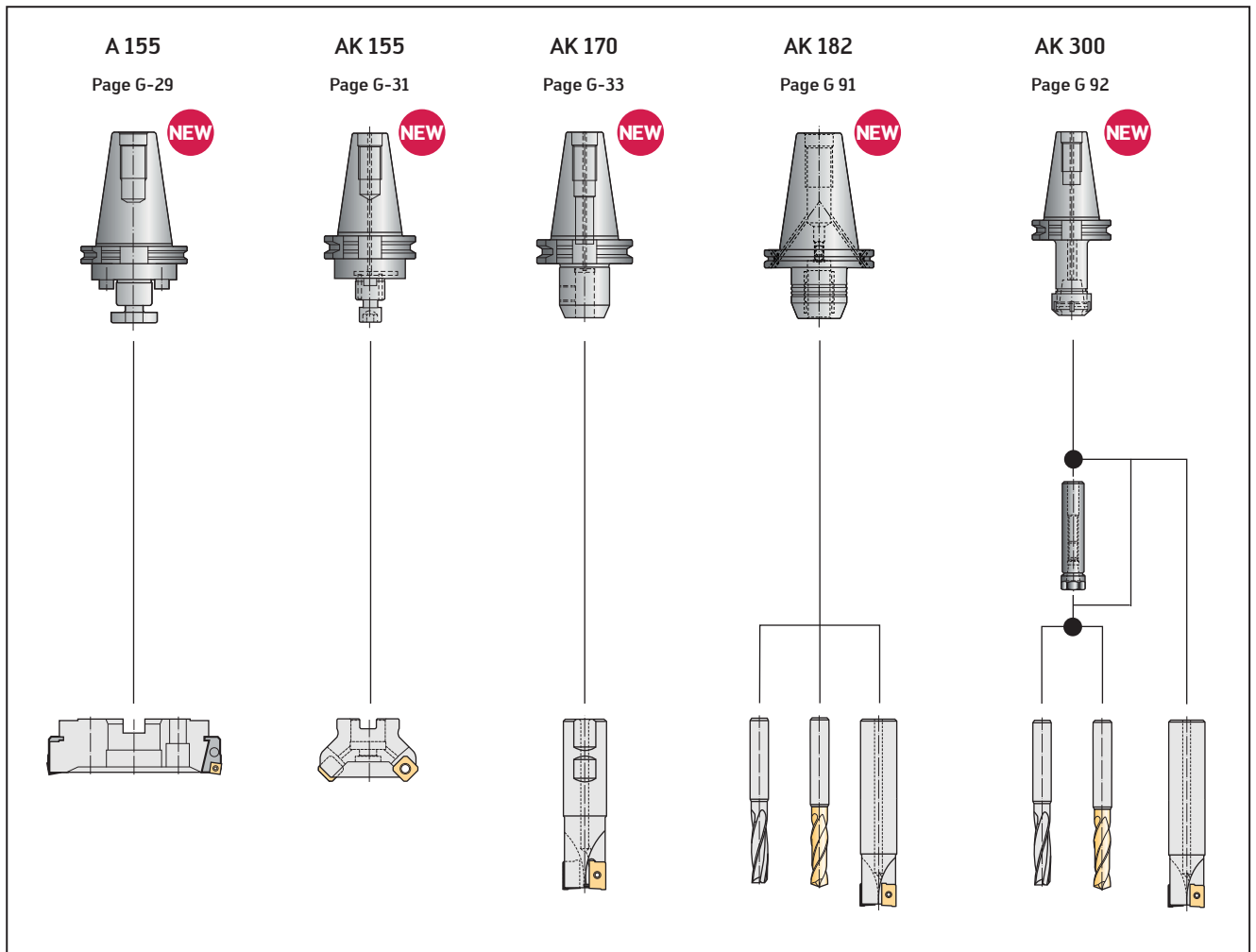

* The pages indicated in italics refer to the Walter General catalogue 2012.

Basic holder DIN 69871 AD
C ... – 390.140
SK40 + SK50

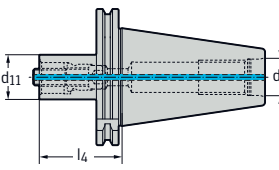

- Walter Capto™ in acc. with ISO 26623

Tool	Designation	SK	d ₁₁ mm	l ₄ mm	d ₁₃ mm	kg
SK DIN69871-AD 	★ C3-390.140-40 030	SK40	C3	30	M16	0,8
	★ C3-390.140-40 060	SK40	C3	60	M16	1
	★ C3-390.140-50 030	SK50	C3	30	M24	2,6
	★ C3-390.140-50 060	SK50	C3	60	M24	2,7
	★ C4-390.140-40 060	SK40	C4	60	M16	1,1
	★ C4-390.140-50 030	SK50	C4	30	M24	2,6
	★ C4-390.140-50 060	SK50	C4	60	M24	2,8
	★ C5-390.140-40 040	SK40	C5	40	M16	0,9
	★ C5-390.140-40 080	SK40	C5	80	M16	1,5
	★ C5-390.140-50 030	SK50	C5	30	M24	2,6
	★ C5-390.140-50 070	SK50	C5	70	M24	3,1
	★ C6-390.140-40 085	SK40	C6	85	M16	1,8
	★ C6-390.140-50 030	SK50	C6	60	M24	2,5
	★ C6-390.140-50 080	SK50	C6	80	M24	3,6
	★ C8-390.140-50 070	SK50	C8	70	M24	3,7
	★ C8-390.140-50 120	SK50	C8	120	M24	5,6

Bodies and assembly parts are included in the scope of delivery.

★ New addition to range

Basic holder MAS-BT JIS B 6339
C ... – 390.58 + C ... – 390.55
SK40 + SK50

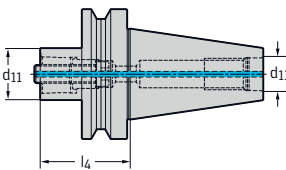

- Walter Capto™ in acc. with ISO 26623

Tool	Designation	d ₁ mm	d ₁₁ mm	l ₄ mm	d ₁₃ mm	kg
JIS B 6339 	★ C3-390.55-40 030	SK40	C3	30	M16	1
	★ C3-390.55-40 060	SK40	C3	60	M16	1,1
	★ C3-390.58-50 040	SK50	C3	40	M24	3,6
	★ C3-390.58-50 070	SK50	C3	70	M24	3,7
	★ C4-390.55-40 030	SK40	C4	30	M16	0,9
	★ C4-390.55-40 060	SK40	C4	60	M16	1,2
	★ C4-390.58-50 040	SK50	C4	40	M24	3,5
	★ C4-390.58-50 070	SK50	C4	70	M24	3,8
	★ C5-390.55-40 050	SK40	C5	50	M16	1,1
	★ C5-390.55-40 090	SK40	C5	90	M16	1,7
	★ C5-390.58-50 040	SK50	C5	40	M24	3,4
	★ C5-390.58-50 080	SK50	C5	80	M24	4
	★ C6-390.55-40 075	SK40	C6	75	M16	1,7
	★ C6-390.58-50 050	SK50	C6	50	M24	3,5
	★ C6-390.58-50 100	SK50	C6	100	M24	4,6
	★ C8-390.58-50 070	SK50	C8	70	M24	4
	★ C8-390.58-50 120	SK50	C8	120	M24	5,9

Bodies and assembly parts are included in the scope of delivery.

Basic holder DIN 69871 AD/AD+B
C ... – 390.540
SK40 + SK50

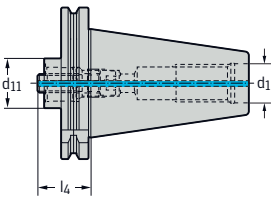
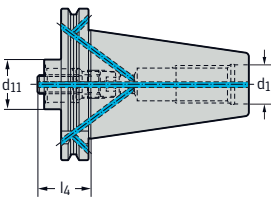

- Walter Capto™ in acc. with ISO 26623
 - BIG PLUS SYSTEM - Licence BIG DAISHOWA

Tool	Designation	d ₁₁ mm	d ₁₁ mm	l ₄ mm	d ₁₃ mm	kg
SK DIN69871-AD 	★ C6-390.540-40 085	SK40	C6	85	M16	2,4
	★ C3-390.540-40 030	SK40	C3	30	M16	0,8
	★ C4-390.540-40 040	SK40	C4	40	M16	0,8
	★ C5-390.540-40 050	SK40	C5	50	M16	0,8
SK DIN69871-AD+B 	★ C8-390.540-50 070A	SK50	C8	70	M24	3,4
	★ C3-390.540-50 030A	SK50	C3	30	M24	2,6
	★ C4-390.540-50 030A	SK50	C4	30	M24	2,6
	★ C5-390.540-50 030A	SK50	C5	30	M24	2,6
	★ C6-390.540-50 050A	SK50	C6	50	M24	2,4

Bodies and assembly parts are included in the scope of delivery.

★ New addition to range

Basic holder MAS-BT JIS B 6339
C ... – 390.558 + C ... – 390.555
SK40 + SK50



- Walter Capto™ in acc. with ISO 26623
 - BIG PLUS SYSTEM - Licence BIG DAISHOWA

Tool	Designation	d ₁ mm	d ₁₁ mm	l ₄ mm	d ₁₃ mm	kg
JIS B 6339 	★ C5-390.555-40 050	SK40	C5	50	M16	1,1
	★ C8-390.558-50 070	SK50	C8	70	M24	4,1
	★ C3-390.555-40 030	SK40	C3	30	M16	1,0
	★ C3-390.558-50 040	SK50	C3	40	M24	3,6
	★ C4-390.555-40 040	SK40	C4	40	M16	1,0
	★ C4-390.558-50 040	SK50	C4	40	M24	3,6
	★ C5-390.558-50 040	SK50	C5	40	M24	3,2
	★ C6-390.555-40 075	SK40	C6	75	M16	1,7
	★ C6-390.558-50 050	SK50	C6	50	M24	3,4

Bodies and assembly parts are included in the scope of delivery.

Collet chuck ISO 26623

C ... – 391.14

Walter Capto™ C3 - C6



- For ER collets in acc. with DIN 6499

Tool	Designation	d ₁ mm	d ₁₁ mm	d ₁₂ mm	l ₄ mm	Collets	kg
Walter Capto™ in acc. with ISO 26623 	C3-391.14-20 045	C3	1-13	35	45	ER 20	0,23
	C4-391.14-20 052	C4	1-13	35	52	ER 20	0,41
	C4-391.14-25 052	C4	1-16	42	52	ER 25	0,7
	C4-391.14-32 054	C4	1-20	50	54	ER 32	0,47
	C5-391.14-20 055	C5	1-13	35	55	ER 20	0,8
	C5-391.14-25 055	C5	1-16	42	55	ER 25	0,6
	C5-391.14-32 057	C5	1-20	50	57	ER 32	0,7
	C6-391.14-20 060	C6	1-13	35	60	ER 20	0,9
	C6-391.14-25 060	C6	1-16	42	60	ER 25	1
	C6-391.14-25 100	C6	1-16	42	100	ER 25	1,4
	C6-391.14-32 060	C6	2-20	50	60	ER 32	1,1
	C6-391.14-32 100	C6	2-20	50	100	ER 32	1,6
	C6-391.14-40 065	C6	3-26	63	65	ER 40	1,2
	★ C8-391.14-25 070	C8	1-16	42	70	ER 25	1,7
	★ C8-391.14-32 070	C8	2-20	50	70	ER 32	1,7
	★ C8-391.14-32 160	C8	2-20	50	160	ER 32	4,1
	★ C8-391.14-40 070	C8	3-26	63	70	ER 40	2,0

For collets, see page G 99 in the Walter General catalogue 2012.
 Bodies and assembly parts are included in the scope of delivery.

Assembly parts	Collets	ER 20	ER 25	ER 32	ER 40
	Clamping nut	FS1451	FS1540	FS1541	FS1542

Accessories	Collets	ER 20	ER 25	ER 32	ER 40
	Tensioning key	FS1539	FS1544	FS1545	FS1546

★ New addition to range

ER collet chuck for internal cooling C ... – 391.14

Walter Capto™ C3 – C6

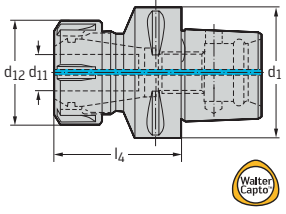

- For ER collets in acc. with DIN 6499

Tool	Designation	d ₁ mm	d ₁₁ mm	d ₁₂ mm	l ₄ mm	Collets		
	Walter Capto™ in acc. with ISO 26623	C3-391.14-20 050	C3	1-13	35	50	ER 20	0,31
	C4-391.14-20 057	C4	1-13	35	57	ER 20	0,49	
	C4-391.14-25 057	C4	1-16	42	57	ER 25	0,8	
	C4-391.14-32 059	C4	1-20	50	59	ER 32	0,6	
	C5-391.14-20 060	C5	1-13	35	60	ER 20	0,9	
	C5-391.14-25 060	C5	1-16	42	60	ER 25	0,8	
	C5-391.14-32 062	C5	1-20	50	62	ER 32	0,9	
	C6-391.14-20 065	C6	1-13	35	65	ER 20	1,1	
	C6-391.14-25 065	C6	1-16	42	65	ER 25	1,2	
	C6-391.14-25 105	C6	1-16	42	105	ER 25	1,5	
	C6-391.14-32 065	C6	2-20	50	65	ER 32	1,2	
	C6-391.14-32 105	C6	2-20	50	105	ER 32	1,8	
	C6-391.14-40 070	C6	3-26	63	70	ER 40	1,5	
	★ C8-391.14-25 075	C8	1-16	42	75	ER 25	1,7	
	★ C8-391.14-32 075	C8	2-20	50	75	ER 32	1,7	
	★ C8-391.14-32 165	C8	2-20	50	165	ER 32	4,1	
	★ C8-391.14-40 075	C8	3-26	63	75	ER 40	2,0	

If the collet chuck is used for the internal coolant supply, use the sealing discs on page G 102 of the Walter General catalogue 2012.

The clamping nut can be damaged if the chuck is used without a sealing disc.

For collets, see page G 99 of the Walter General catalogue 2012.

Bodies and assembly parts are included in the scope of delivery.

Assembly parts	Collets	ER 20	ER 25	ER 32	ER 40
	Clamping nut for internal coolant supply	FS1359	FS1449	FS1360	FS1450

Accessories	Collets	ER 20	ER 25	ER 32	ER 40
	Tensioning key	FS1539	FS1544	FS1545	FS1546

★ New addition to range

Reduction adaptor C ... – 391.02

Walter Capto™ C4 - C8



Tool	Designation	d ₁ mm	d ₁₁ mm	l ₄ mm	l ₁₆ mm	kg	
Walter Capto™ in acc. with ISO 26623 	C4-391.02-32 055A	C4	C3	55	31,0	0,45	
	C5-391.02-32 060A	C5	C3	60	35,0	0,7	
	C5-391.02-40 065A	C5	C4	65	40,0	0,8	
	C6-391.02-32 070A	C6	C4	70	39,0	1,1	
	C6-391.02-40 080A	C6	C4	80	51,3	1,3	
	C6-391.02-50 080A	C6	C5	80	51,5	1,5	
	★ C8-391.02-32 060A	C8	C3	60	29,0	1,7	
	★ C8-391.02-40 070A	C8	C4	70	36,0	1,9	
	C8-391.02-50 080A	C8	C5	80	49,3	2,3	
	C8-391.02-63 080A	C8	C6	80	53,1	2,5	
	Walter Capto™ in acc. with ISO 26623 	C4-391.02-32 070A	C4	C3	70	12,0	0,6
		C5-391.02-40 085A	C5	C4	85	12,0	1,1
C6-391.02-50 110A		C6	C5	110	12,0	2,2	
C8-391.02-63 120A		C8	C6	120	12,0	2,1	
Walter Capto™ in acc. with ISO 26623 short version 	C5-391.02-32 033*	C5	C3	33	10	0,5	
	C5-391.02-40 040*	C5	C4	40	18	0,6	
	C6-391.02-32 032*	C6	C3	32	6	0,9	
	C6-391.02-40 040*	C6	C4	40	11,3	1	
	C6-391.02-50 050*	C6	C5	50	24,5	1,1	
	C8-391.02-50 045	C8	C5	45	10	1,9	
	C8-391.02-63 055	C8	C6	55	20	2,1	

Bodies and assembly parts are included in the scope of delivery.

* Short version only for bushing clamp.

Boring bar holder AK 600

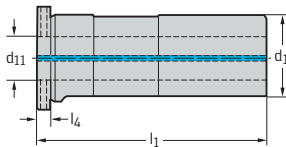

- With Weldon shank in acc. with DIN 9766
- Self centring for cylindrical round shank

Tool	Designation	d ₁ mm	d ₁₁ mm	l ₁ mm	l ₄ mm	
	AK600.25.061.06	25	6	61	5	0,2
	AK600.25.061.08	25	8	61	5	0,2
	AK600.25.061.10	25	10	61	5	0,2
	AK600.25.061.12	25	12	61	5	0,1
	AK600.25.061.16	25	16	61	5	0,2
	AK600.32.085.06	32	6	85	5	0,6
	AK600.32.085.08	32	8	85	5	0,5
	AK600.32.085.10	32	10	85	5	0,5
	AK600.32.085.12	32	12	85	5	0,5
	AK600.32.085.16	32	16	85	5	0,4
	AK600.32.085.20	32	20	85	5	0,3
	AK600.40.105.06	40	6	105	5	1,1
	AK600.40.105.08	40	8	105	5	1,0
	AK600.40.105.10	40	10	105	5	0,9
	AK600.40.105.12	40	12	105	5	0,9
	AK600.40.105.16	40	16	105	5	0,9
	AK600.40.105.20	40	20	105	5	0,8
	★ AK600.40.105.25	40	25	105	5	0,7

Note: The groove for the self centring of the boring bar is present on all Walter Turn boring bars with cylindrical shank Ø 6–25 mm.

Master VDI DIN 69880
AK 135M
VDI 40, 50 + 60



- Modular NCT adaptor

Tool	Designation	d ₁ mm	d ₁₁ mm	d ₁₄ mm	l ₄ mm	kg
VDI DIN 69880	★ AK135M.5.40.060.N8	40	NCT80	83	60	2,7
	★ AK135M.5.50.060.N8	50	NCT80	98	60	3,7
	★ AK135M.5.60.060.N8	60	NCT80	123	60	5,5

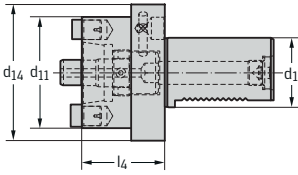

★ New addition to range

Adaptor DIN 1835 A AK 512



- For NCT ScrewFit front pieces
- Steel shank with solid carbide core

Tool	Designation	d ₁ mm	d ₁₁ mm	l ₁₆ mm	l ₄ mm	l ₁ mm	Version	kg		
Shank DIN 1835 A	★ AK512.Z16.T14.070	16	T14	38	70	120	B	0,2		
	★ AK512.Z16.T14.120	16	T14	37	120	170	B	0,3		
	★ AK512.Z20.T18.123	20	T18	45	123	175	A	0,5		
	★ AK512.Z25.T22.122	25	T22	55	122	180	A	0,8		
	★ AK512.Z25.T28.127	25	T28	60	127	185	C	0,9		
	★ AK512.Z32.T28.283	32	T28	60	283	345	B	2,6		
A 										
	B 									
		C 								



Adaptor DIN 69871 AD+B

AK 540

SK40



- For NCT ScrewFit front pieces

Tool	Designation	d ₁ mm	d ₁₁ mm	d ₁₄ mm	l ₄ mm	l ₁₆ mm	l ₁₈ mm	kg
SK DIN 69871 AD+B 	AK540.S40.T09.040	SK40	T09	12	40	17	10	0,9
	AK540.S40.T09.065	SK40	T09	12	65	31	10	0,9
	AK540.S40.T09.090	SK40	T09	12	90	31	10	0,9
	AK540.S40.T14.045	SK40	T14	16	45	17	10	0,9
	AK540.S40.T14.070	SK40	T14	16	70	24	10	0,9
	AK540.S40.T14.095	SK40	T14	16	95	24	10	1,0
	AK540.S40.T14.120	SK40	T14	16	120	24	10	1,0
	★ AK540.S40.T18.040CO	SK40	T18	20	40	16	10	0,82
	AK540.S40.T18.050CO*	SK40	T18	20	50	22	10	0,9
	AK540.S40.T18.075	SK40	T18	20	75	24	10	1,0
	AK540.S40.T18.100	SK40	T18	20	100	24	10	1,0
	AK540.S40.T18.125	SK40	T18	20	125	24	10	1,2
	AK540.S40.T18.150	SK40	T18	20	150	24	10	1,3
	★ AK540.S40.T22.040CO	SK40	T22	25	40	16	10	0,83
	AK540.S40.T22.060CO*	SK40	T22	25	60	32	10	0,9
	AK540.S40.T22.085	SK40	T22	25	85	38	10	1,0
	AK540.S40.T22.110	SK40	T22	25	110	38	10	1,1
	AK540.S40.T22.135	SK40	T22	25	135	38	10	1,4
	AK540.S40.T22.160	SK40	T22	25	160	38	10	1,5
	AK540.S40.T28.040CO*	SK40	T28	32	40	17	10	0,9
	AK540.S40.T28.065	SK40	T28	32	65	37	10	1,0
	AK540.S40.T28.090	SK40	T28	32	90	48	10	1,2
	AK540.S40.T28.115	SK40	T28	32	115	48	10	1,3
	AK540.S40.T28.140	SK40	T28	32	140	48	10	1,6
	AK540.S40.T28.165	SK40	T28	32	165	48	10	1,9
	AK540.S40.T36.040CO*	SK40	T36	40	40	17	10	0,9
	AK540.S40.T36.065	SK40	T36	40	65	40	10	1,1
	AK540.S40.T36.090	SK40	T36	40	90	48	10	1,4
	AK540.S40.T36.115	SK40	T36	40	115	48	10	1,7
	AK540.S40.T45.040CO*	SK40	T45	50	40	17	10	1,0
	AK540.S40.T45.065	SK40	T45	50	65	42	10	1,3
	AK540.S40.T45.090	SK40	T45	50	90	67	10	2,0

The delivery status is form AD. To convert to form B, remove the two threaded plugs.

Bodies and assembly parts are included in the scope of delivery.

For pull studs for steep tapers, see page H 42 of the Walter General catalogue 2012.

* ... CO = Interface is cutting edge oriented. For using B 4030.T and B 3230.T.

Assembly parts

	d ₁ mm	SK40
	Threaded plug DIN 913	M04X005 DIN 913

★ New addition to range

Adaptor DIN 69871 AD+B

AK 540

SK50

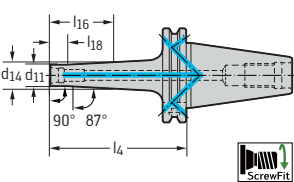

- For NCT ScrewFit front pieces

Tool	Designation	d ₁ mm	d ₁₁ mm	d ₁₄ mm	l ₄ mm	l ₁₆ mm	l ₁₈ mm	kg
	SK DIN 69871 AD+B							
	AK540.S50.T22.050CO*	SK50	T22	25	50	25	10	2,8
	AK540.S50.T22.100	SK50	T22	25	100	38	10	3,0
	AK540.S50.T22.150	SK50	T22	25	150	38	10	3,4
	AK540.S50.T22.200	SK50	T22	25	200	38	10	3,8
	AK540.S50.T28.050CO*	SK50	T28	32	50	25	10	2,9
	AK540.S50.T28.100	SK50	T28	32	100	48	10	3,2
	AK540.S50.T28.150	SK50	T28	32	150	48	10	3,6
	AK540.S50.T28.200	SK50	T28	32	200	48	10	4,8
	AK540.S50.T28.250	SK50	T28	32	250	48	10	4,7
	AK540.S50.T36.050CO*	SK50	T36	40	50	25	10	2,9
	AK540.S50.T36.100	SK50	T36	40	100	48	10	3,4
	AK540.S50.T36.150	SK50	T36	40	150	48	10	4,1
	AK540.S50.T36.200	SK50	T36	40	200	48	10	4,9
	AK540.S50.T36.250	SK50	T36	40	250	48	10	5,7
	AK540.S50.T45.050CO*	SK50	T45	50	50	25	10	3,0
	AK540.S50.T45.100	SK50	T45	50	100	57	10	3,8
	AK540.S50.T45.150	SK50	T45	50	150	57	10	4,7
	AK540.S50.T45.200	SK50	T45	50	200	57	10	5,8
	AK540.S50.T45.250	SK50	T45	50	250	57	10	7,0

The delivery status is form AD. To convert to form B, remove the two threaded plugs.

Bodies and assembly parts are included in the scope of delivery.

For pull studs for steep tapers, see page H 42 of the Walter General catalogue 2012.

* ... CO = Interface is cutting edge oriented. For using B 4030.T and B 3230.T.

Assembly parts

	d ₁ mm	SK50
	Threaded plug DIN 913	M06X006 DIN 913

Adaptor MAS-BT JIS B 6339

AK 540

SK40



- For NCT ScrewFit front pieces

Tool	Designation	d ₁ mm	d ₁₁ mm	d ₁₄ mm	l ₄ mm	l ₁₆ mm	l ₁₈ mm	kg
	JIS B 6339							
	AK540.BT40.T09.050	SK40	T09	12	50	17	10	1,1
	AK540.BT40.T09.075	SK40	T09	12	75	31	10	1,1
	AK540.BT40.T09.100	SK40	T09	12	100	31	10	1,1
	AK540.BT40.T14.055	SK40	T14	16	55	22	10	1,1
	AK540.BT40.T14.080	SK40	T14	16	80	24	10	1,1
	AK540.BT40.T14.105	SK40	T14	16	105	24	10	1,2
	AK540.BT40.T14.130	SK40	T14	16	130	24	10	1,3
	AK540.BT40.T18.060CO*	SK40	T18	20	60	24	10	1,1
	AK540.BT40.T18.085	SK40	T18	20	85	24	10	1,1
	AK540.BT40.T18.110	SK40	T18	20	110	24	10	1,3
	AK540.BT40.T18.135	SK40	T18	20	135	24	10	1,4
	AK540.BT40.T18.160	SK40	T18	20	160	24	10	1,6
	★ AK540.BT40.T22.050CO	SK40	T22	25	50	17	10	1,01
	AK540.BT40.T22.070CO*	SK40	T22	25	70	37	10	1,0
	AK540.BT40.T22.095	SK40	T22	25	95	38	10	1,3
	AK540.BT40.T22.120	SK40	T22	25	120	38	10	1,6
	AK540.BT40.T22.145	SK40	T22	25	145	38	10	1,6
	AK540.BT40.T22.170	SK40	T22	25	170	38	10	1,8
	AK540.BT40.T28.050CO*	SK40	T28	32	50	17	10	1,1
	AK540.BT40.T28.075	SK40	T28	32	75	42	10	1,2
	AK540.BT40.T28.100	SK40	T28	32	100	48	10	1,4
	AK540.BT40.T28.125	SK40	T28	32	125	48	10	1,6
	AK540.BT40.T28.150	SK40	T28	32	150	48	10	1,9
	AK540.BT40.T28.175	SK40	T28	32	175	48	10	2,1
	AK540.BT40.T36.075CO*	SK40	T36	40	75	42	10	1,3
	AK540.BT40.T36.100	SK40	T36	40	100	48	10	1,6
	AK540.BT40.T36.125	SK40	T36	40	125	48	10	1,9
	AK540.BT40.T45.075CO*	SK40	T45	50	75	42	10	1,6
	AK540.BT40.T45.100	SK40	T45	50	100	57	10	1,9

For pull studs for steep tapers, see page H 42 of the Walter General catalogue 2012.

* ... CO = Interface is cutting edge oriented. For using B 4030.T and B 3230.T.

★ New addition to range

Adaptor MAS-BT JIS B 6339

AK 540

SK50

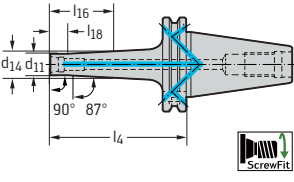

- For NCT ScrewFit front pieces

Tool	Designation	d ₁ mm	d ₁₁ mm	d ₁₄ mm	l ₄ mm	l ₁₆ mm	l ₁₈ mm	kg
JIS B 6339 	AK540.BT50.T22.070CO*	SK50	T22	25	70	26	10	3,9
	AK540.BT50.T22.120	SK50	T22	25	120	38	10	4,0
	AK540.BT50.T22.170	SK50	T22	25	170	38	10	4,4
	AK540.BT50.T22.220	SK50	T22	25	220	38	10	4,9
	AK540.BT50.T28.070CO*	SK50	T28	32	70	26	10	3,9
	AK540.BT50.T28.120	SK50	T28	32	120	48	10	4,2
	AK540.BT50.T28.170	SK50	T28	32	170	48	10	4,7
	AK540.BT50.T28.220	SK50	T28	32	220	48	10	5,2
	AK540.BT50.T28.270	SK50	T28	32	270	48	10	5,7
	AK540.BT50.T36.070CO*	SK50	T36	40	70	26	10	3,9
	AK540.BT50.T36.120	SK50	T36	40	120	48	10	4,4
	AK540.BT50.T36.170	SK50	T36	40	170	48	10	5,1
	AK540.BT50.T36.220	SK50	T36	40	220	48	10	5,9
	AK540.BT50.T36.270	SK50	T36	40	270	48	10	6,9
	AK540.BT50.T45.070CO*	SK50	T45	50	70	26	10	4,1
	AK540.BT50.T45.120	SK50	T45	50	120	57	10	4,8
	AK540.BT50.T45.170	SK50	T45	50	170	57	10	5,7
	AK540.BT50.T45.220	SK50	T45	50	220	57	10	6,6
	AK540.BT50.T45.270	SK50	T45	50	270	57	10	8,0

For pull studs for steep tapers, see page H 42 of the Walter General catalogue 2012.

* ... CO = Interface is cutting edge oriented. For using B 4030.T and B 3230.T.

ScrewFit to ConeFit Adaptor AK523.T



- For ConeFit front pieces

Tool	Designation	d ₁ mm	d ₁₁ mm	l ₄ mm	l ₁₈ mm	kg
NCT ScrewFit 	★ AK523.T14.10.E12	T14	E12	25	10	0,054
NCT ScrewFit 	★ AK523.T14.25.E16	T14	E16	25		0,062
	★ AK523.T18.30.E20	T18	E20	30		0,11
	★ AK523.T22.35.E25	T22	E25	35		0,2

★ New addition to range

Adaptor DIN 6335 HA AK610



- For ConeFit™ mill heads

Tool	Designation	d ₁ mm	d ₁₁ mm	l ₄ mm	l ₁ mm	Version	kg
Shank DIN 6335 HA with coolant supply 	AK610.Z16.E10.005	10	E10	5	65	A	0,11
	★ AK610.Z12.E10.005	10	E10	5	65	A	0,067
	AK610.Z10.E10.020	10	E10	20	75	A	0,05
	AK610.Z16.E10.036	10	E10	36,5	140	C	0,2
	AK610.Z16.E10.050	10	E10	50	160	B	0,21
	AK610.Z16.E12.005	12	E12	5	65	A	0,1
	AK610.Z12.E12.022	12	E12	22	100	A	0,087
	AK610.Z16.E12.025	12	E12	25,1	140	C	0,2
	AK610.Z16.E12.060	12	E12	60	170	B	0,22
	AK610.Z20.E16.005	16	E16	5	70	A	0,17
	★ AK610.Z16.E16.025	16	E16	25	110	A	0,17
	AK610.Z20.E16.025	16	E16	25	110	A	0,24
	AK610.Z25.E16.054	16	E16	54,8	170	C	0,6
	AK610.Z20.E16.075	16	E16	75	190	B	0,39
	AK610.Z25.E20.005	20	E20	5	80	A	0,28
	AK610.Z20.E20.030	20	E20	30	120	A	0,26
	AK610.Z32.E20.073	20	E20	73,1	180	C	1
	★ AK610.Z20.E20.110C	20	E20	110	180	A	0,7
	AK610.Z32.E25.005	25	E25	5	80	A	0,46
	AK610.Z25.E25.040	25	E25	40	140	A	0,5
	AK610.Z32.E25.045	25	E25	45,1	200	C	1,2

★ New addition to range

Adaptors DIN 6335 HA AK610



- For ConeFit™ mill heads
- With solid carbide shank

Tool	Designation	d ₁ mm	d ₁₁ mm	l ₄ mm	l ₁ mm	Version	kg	
Shank DIN 6335 HA with coolant supply 	AK610.Z10.E10.050C	10	E10	50	100	A	0,1	
	AK610.Z16.E10.100C	10	E10	100	155	B	0,3	
	AK610.Z12.E12.048C	12	E12	48	100	A	0,14	
	AK610.Z16.E12.090C	12	E12	90	150	B	0,34	
	AK610.Z16.E16.080C	16	E16	80	135	A	0,34	
	AK610.Z20.E16.118C	16	E16	118	175	B	0,6	
	AK610.Z20.E20.038C	20	E20	38	95	A	0,34	
	★ AK610.Z20.E20.110C	20	E20	110	180	A	0,7	
	AK610.Z25.E25.120C	25	E25	120	200	A	1,2	

★ New addition to range

Adaptor with parallel shank A159



- For honeycomb milling cutters

Tool		d ₁ mm	d ₁₁ mm	l ₁ mm	l ₄ mm	l ₁₉ mm	Kg
Shank DIN6335HA	A159.Z16.013.13	16	13	72	11	13,5	0,13
	A159.Z16.016.13	16	16	72	11	13	0,15

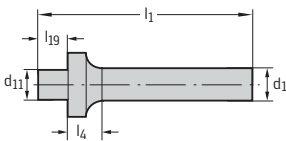

Bodies and assembly parts are included in the scope of delivery.

Assembly parts		d ₁₁ mm	13	16
	Feather key		FS2153	FS2154
	Clamping screw		FS2151	FS2152

Accessories		d ₁₁ mm	13	16
	Hex nut driver DIN3116		A13	C18

Hydraulic expansion chuck DIN 69893/1 A AK182.H

HSK63 + HSK100



- For tools with shank in acc. with DIN 1835

Tool	Designation	d ₁ mm	d ₁₁ mm	d ₁₂ mm	l ₄ mm	d ₁₄ mm	l ₁₆ mm	l ₁₇ mm	l _{17min} mm	kg
HSK DIN 69893/1 A 	★ AK182.H100.090.20	HSK-A100	20		90	52,5	61	51	41	2,8
	★ AK182.H100.100.32	HSK-A100	32		100	72	71	61	51	3,8
	★ AK182.H63.080.12	HSK-A63	12	52,5	80	42	54	46	36	1,3
	★ AK182.H63.080.20	HSK-A63	20		80	52,5	54	51	41	1,3

Bodies and assembly parts are included in the scope of delivery.

For accessories for HSK, see page H 42 of the Walter General catalogue 2012.

Accessories

	d ₄ mm	d ₄ mm									
		3	4	5	6	7	8	9	10	11	
Adaptor sleeves for peripheral cooling 	d ₁ = 12 mm	FS2194	FS2195	FS2196	FS2197	-	FS2198	-	-	-	
	d ₁ = 20 mm	FS2213	FS2214	FS2215	FS2216	-	FS2217	-	FS2218	-	
	d ₁ = 32 mm	-	-	-	FS2231	-	FS2232	-	FS2233	-	
Adaptor sleeves sealed for internal cooling	d ₁ = 12 mm	FS2189	FS2190	FS2191	FS2192	-	FS2193	-	-	-	
	d ₁ = 20 mm	FS2199	FS2200	FS2201	FS2202	FS2203	FS2204	FS2205	FS2206	FS2207	
	d ₁ = 32 mm	-	-	-	FS2222	-	FS2223	-	FS2224	-	
Continued	d₄ mm	12	13	14	15	16	18	20	25		
Adaptor sleeves for peripheral cooling	d ₁ = 12 mm	-	-	-	-	-	-	-	-		
	d ₁ = 20 mm	FS2219	-	FS2220	-	FS2221	-	-	-		
	d ₁ = 32 mm	FS2234	-	FS2235	-	FS2236	FS2237	FS2238	FS2239		
Adaptor sleeves sealed for internal cooling	d ₁ = 12 mm	-	-	-	-	-	-	-	-		
	d ₁ = 20 mm	FS2208	FS2209	FS2210	FS2211	FS2212	-	-	-		
	d ₁ = 32 mm	FS2225	-	FS2226	-	FS2227	FS2228	FS2229	FS2230		

★ New addition to range

Face mill adaptor DIN69871-A

A 155.S ...

SK40 + SK50

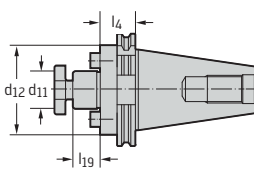

- For tools in acc. with DIN 1880

Tool	Designation	d ₁ mm	d ₁₁ mm	d ₁₂ mm	l ₄ mm	l ₁₉ mm	
SK DIN 69871-A 	★ A155.S40.035.16	SK40	16	36	35	17	0,9
	★ A155.S40.035.22	SK40	22	48	35	19	1,1
	★ A155.S40.035.27	SK40	27	48	35	21	1,2
	★ A155.S40.050.32	SK40	32	78	50	24	1,8
	★ A155.S40.100.16	SK40	16	36	100	17	1,9
	★ A155.S40.100.22	SK40	22	48	100	19	2
	★ A155.S40.100.27	SK40	27	60	100	21	2,5
	★ A155.S40.100.32	SK40	32	78	100	24	3,6
	★ A155.S50.035.22	SK50	22	48	35	19	2,9
	★ A155.S50.035.27	SK50	27	60	35	21	3,1
	★ A155.S50.035.32	SK50	32	78	35	24	3,4
	★ A155.S50.050.40*	SK50	40	89	50	27	4,1
	★ A155.S50.070.60*	SK50	60	127	70	40	7,2
	★ A155.S50.100.22	SK50	22	48	100	19	4,6
	★ A155.S50.100.27	SK50	27	60	100	21	5,3
	★ A155.S50.100.32	SK50	32	78	100	24	6,6
	★ A155.S50.100.40*	SK50	40	89	100	27	9,5

Bodies and assembly parts are included in the scope of delivery.

For pull studs for steep tapers, see page H 42 of the Walter General catalogue 2012.

* With 4 additional threaded holes for tools with DIN 2079 tooling connection.

Assembly parts		d ₁₁ mm	16	22	27	32	40	60
	Milling cutter tightening screw DIN 6367		FS430	FS431	FS432	FS433	FS434	FS912

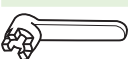
Accessories		d ₁₁ mm	16	22	27	32	40	60
	Wrench for milling cutter tightening screw		FS436	FS437	FS438	FS439	FS440	FS913

★ New addition to range

Face mill adaptor MAS-BT JIS B 6339

A 155.BT ...

SK40 + SK50



- For tools in acc. with DIN 1880

Tool	Designation	d ₁ mm	d ₁₁ mm	d ₁₂ mm	l ₄ mm	l ₁₉ mm	
JIS B 6339 	★ A155.BT40.035.16	SK40	16	36	35	17	1,1
	★ A155.BT40.035.22	SK40	22	48	35	19	1,2
	★ A155.BT40.035.27	SK40	27	48	35	21	1,3
	★ A155.BT40.065.32	SK40	32	78	65	24	2
	★ A155.BT40.100.16	SK40	16	36	100	17	1,8
	★ A155.BT40.100.22	SK40	22	48	100	19	2
	★ A155.BT40.100.27	SK40	27	60	100	21	2,5
	★ A155.BT50.055.22	SK50	22	48	55	19	3,7
	★ A155.BT50.055.27	SK50	27	60	55	21	3,9
	★ A155.BT50.055.32	SK50	32	78	55	24	4,2
	★ A155.BT50.055.40*	SK50	40	89	55	27	4,9
	★ A155.BT50.080.60*	SK50	60	127	80	40	3,8
	★ A155.BT50.100.22	SK50	22	48	100	19	4,5
	★ A155.BT50.100.27	SK50	27	60	100	21	5,8
	★ A155.BT50.100.32	SK50	32	78	100	24	6,5

Bodies and assembly parts are included in the scope of delivery.

For pull studs for steep tapers, see page H 42 of the Walter General catalogue 2012.

* With 4 additional threaded holes for tools with DIN 2079 tooling connection.

Assembly parts	d ₁₁ mm	16	22	27	32	40	60
Milling cutter tightening screw DIN 6367		FS430	FS431	FS432	FS433	FS434	FS912

Accessories	d ₁₁ mm	16	22	27	32	40	60
Wrench for milling cutter tightening screw		FS436	FS437	FS438	FS439	FS440	FS913

★ New addition to range

Face mill adaptor DIN 69871 AD+B AK 155.S ... SK40 + SK50

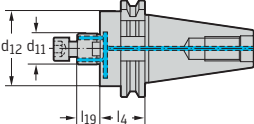

- For tools in acc. with DIN 1880

Tool	Designation	d ₁ mm	d ₁₁ mm	d ₁₂ mm	l ₄ mm	l ₁₉ mm	
SK DIN 69871 AD+B 	★ AK155.S40.035.16	SK40	16	36	35	17	0,9
	★ AK155.S40.035.22	SK40	22	48	35	19	1,1
	★ AK155.S40.035.27	SK40	27	48	35	21	1,2
	★ AK155.S40.050.32	SK40	32	78	50	24	1,8
	★ AK155.S50.035.16	SK50	16	36	35	17	2,7
	★ AK155.S50.035.22	SK50	22	48	35	19	2,9
	★ AK155.S50.035.27	SK50	27	60	35	21	3,1
	★ AK155.S50.035.32	SK50	32	78	35	24	3,4

Bodies and assembly parts are included in the scope of delivery.

For pull studs for steep tapers, see page H 42 of the Walter General catalogue 2012.

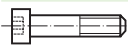
Assembly parts	d ₁₁ mm	16	22	27	32
	Tightening screw ISO 4762	FS938 (SW 6)	FS939 (SW 8)	FS940 (SW 10)	FS941 (SW 14)

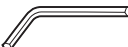
Accessories	d ₁₁ mm	16	22	27	32
	Allen key ISO 2936	ISO2936-6 (SW 6)	ISO2936-8 (SW 8)	ISO2936-10 (SW 10)	ISO2936-14 (SW 14)

★ New addition to range



G-41

Face mill adaptor MAS-BT JIS B 6339

AK 155.BT ...

SK40 + SK50



- For tools in acc. with DIN 1880

Tool	Designation	d ₁ mm	d ₁₁ mm	d ₁₂ mm	l ₄ mm	l ₁₉ mm	
JIS B 6339 	★ AK155.BT40.035.16	SK40	16	36	35	17	1,1
	★ AK155.BT40.035.22	SK40	22	48	35	19	1,2
	★ AK155.BT40.035.27	SK40	27	48	35	21	1,3
	★ AK155.BT40.065.32	SK40	32	78	65	24	2
	★ AK155.BT50.055.16	SK50	16	36	55	17	3,5
	★ AK155.BT50.055.22	SK50	22	48	55	19	3,7
	★ AK155.BT50.055.27	SK50	27	60	55	21	3,9
	★ AK155.BT50.055.32	SK50	32	78	55	24	4,2

Bodies and assembly parts are included in the scope of delivery.

For pull studs for steep tapers, see page H 42 of the Walter General catalogue 2012.

Assembly parts	d ₁₁ mm	16	22	27	32
	Tightening screw ISO 4762	FS938 (SW 6)	FS939 (SW 8)	FS940 (SW 10)	FS941 (SW 14)

Accessories	d ₁₁ mm	16	22	27	32
	Allen key ISO 2936	ISO2936-6 (SW 6)	ISO2936-8 (SW 8)	ISO2936-10 (SW 10)	ISO2936-14 (SW 14)

★ New addition to range



G-41

Weldon adaptor DIN 69871 AD+B AK 170.S ... SK40 + SK50

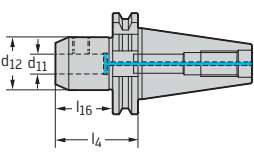

- For tools with shank in acc. with DIN 1835 Form B

Tool	Designation	d ₁ mm	d ₁₁ mm	d ₁₂ mm	l ₄ mm	l ₁₆ mm	
SK DIN 69871 AD+B 	★ AK170.S40.050.06	SK40	6	25	50	35	0,9
	★ AK170.S40.050.08	SK40	8	28	50	35	0,9
	★ AK170.S40.050.10	SK40	10	35	50	39	1
	★ AK170.S40.050.12	SK40	12	42	50	44	1
	★ AK170.S40.050.14	SK40	14	42	50	44	1
	★ AK170.S40.063.16	SK40	16	48	63	47	1
	★ AK170.S40.063.18	SK40	18	48	63	47	1,2
	★ AK170.S40.063.20	SK40	20	52	63	49	1,3
	★ AK170.S40.100.25	SK40	25	65	100	59	2,3
	★ AK170.S40.100.32	SK40	32	72	100	63	2,5
	★ AK170.S50.063.06	SK50	6	25	63	35	2,8
	★ AK170.S50.063.08	SK50	8	28	63	35	2,7
	★ AK170.S50.063.10	SK50	10	35	63	39	2,9
	★ AK170.S50.063.12	SK50	12	42	63	44	3
	★ AK170.S50.063.14	SK50	14	42	63	44	3
	★ AK170.S50.063.16	SK50	16	48	63	47	3,1
	★ AK170.S50.063.18	SK50	18	48	63	47	3
	★ AK170.S50.063.20	SK50	20	52	63	49	3,1
	★ AK170.S50.080.25	SK50	25	65	80	59	3,8
	★ AK170.S50.100.32	SK50	32	72	100	63	4,5
	★ AK170.S50.100.40	SK50	40	78	100	73	4,7

Bodies and assembly parts are included in the scope of delivery.

For pull studs for steep tapers, see page H 42 of the Walter General catalogue 2012.

Assembly parts	d ₁₁ mm	6	8	10	12-14	16-18	20	25	32-40
 Clamping screw DIN 1835-B		M06X010	M08X010	M10X012	M12X016	M14X016	M16X016	M18X2X020	M20X2X020

★ New addition to range

Weldon adaptor MAS-BT JIS B 6339

AK 170.BT ...

SK40 + SK50



- For tools with shank in acc. with DIN 1835 Form B

Tool	Designation	d ₁ mm	d ₁₁ mm	d ₁₂ mm	l ₄ mm	l ₁₆ mm	kg
JIS B 6339 	★ AK170.BT40.050.06	SK40	6	25	50	35	0,9
	★ AK170.BT40.050.08	SK40	8	28	50	35	1
	★ AK170.BT40.063.10	SK40	10	35	63	39	1,1
	★ AK170.BT40.063.12	SK40	12	42	63	44	1,2
	★ AK170.BT40.063.14	SK40	14	44	63	44	1,2
	★ AK170.BT40.063.16	SK40	16	48	63	47	1,2
	★ AK170.BT40.063.18	SK40	18	50	63	47	1,3
	★ AK170.BT40.063.20	SK40	20	52	63	49	1,4
	★ AK170.BT40.090.25	SK40	25	65	90	59	2,4
	★ AK170.BT40.100.32	SK40	32	72	100	63	2,6
	★ AK170.BT50.063.06	SK50	6	25	63	35	3,6
	★ AK170.BT50.063.08	SK50	8	28	63	35	3,5
	★ AK170.BT50.070.10	SK50	10	35	70	39	3,7
	★ AK170.BT50.080.12	SK50	12	42	80	44	3,8
	★ AK170.BT50.080.16	SK50	16	48	80	47	3,9
	★ AK170.BT50.080.20	SK50	20	52	80	49	3,9
	★ AK170.BT50.100.25	SK50	25	65	100	59	4,6
	★ AK170.BT50.105.32	SK50	32	72	105	63	5,3
	★ AK170.BT50.115.40	SK50	40	78	115	75	5,5

Bodies and assembly parts are included in the scope of delivery.

For pull studs for steep tapers, see page H 42 of the Walter General catalogue 2012.

Assembly parts	d ₁₁ mm	6	8	10	12-14	16-18	20	25	32-40
Clamping screw DIN 1835-B		M06X010	M08X010	M10X012	M12X016	M14X016	M16X016	M18X2X020	M20X2X020

★ New addition to range

Hydraulic expansion chuck DIN 69871 AD+B AK 182.S ...

SK40 + SK50

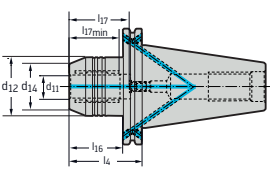

- For tools with shank in acc. with DIN 1835

Tool	Designation	d ₁ mm	d ₁₁ mm	d ₁₂ mm	l ₄ mm	d ₁₄ mm	l ₁₆ mm	l ₁₇ mm	l _{17min} mm	
SK DIN 69871 AD+B 	★ AK182.S40.050.12	SK40	12	42	50	32	31	46	36	1,1
	★ AK182.S40.065.20	SK40	20	49,25	65	38	45,5	51	41	1,3
	★ AK182.S50.065.20	SK50	20	49,25	65	38	45,5	51	41	3,1
	★ AK182.S50.081.32	SK50	32	72	81	58,5	62	61	51	4,1

The delivery status is form AD. To convert to form B, remove the two threaded plugs.

Bodies and assembly parts are included in the scope of delivery.

For pull studs for steep tapers, see page H 42 of the Walter General catalogue 2012.

Accessories

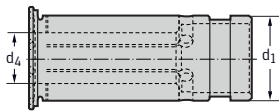

	d ₄ mm	3	4	5	6	7	8	9	10	11
Adaptor sleeves for peripheral cooling	d ₁ = 12 mm	FS2194	FS2195	FS2196	FS2197	-	FS2198	-	-	-
	d ₁ = 20 mm	FS2213	FS2214	FS2215	FS2216	-	FS2217	-	FS2218	-
	d ₁ = 32 mm	-	-	-	FS2231	-	FS2232	-	FS2233	-
Adaptor sleeves sealed for internal cooling	d ₁ = 12 mm	FS2189	FS2190	FS2191	FS2192	-	FS2193	-	-	-
	d ₁ = 20 mm	FS2199	FS2200	FS2201	FS2202	FS2203	FS2204	FS2205	FS2206	FS2207
	d ₁ = 32 mm	-	-	-	FS2222	-	FS2223	-	FS2224	-
Continued	d₄ mm	12	13	14	15	16	18	20	25	
Adaptor sleeves for peripheral cooling	d ₁ = 12 mm	-	-	-	-	-	-	-	-	-
	d ₁ = 20 mm	FS2219	-	FS2220	-	FS2221	-	-	-	-
	d ₁ = 32 mm	FS2234	-	FS2235	-	FS2236	FS2237	FS2238	FS2239	
Adaptor sleeves sealed for internal cooling	d ₁ = 12 mm	-	-	-	-	-	-	-	-	-
	d ₁ = 20 mm	FS2208	FS2209	FS2210	FS2211	FS2212	-	-	-	-
	d ₁ = 32 mm	FS2225	-	FS2226	-	FS2227	FS2228	FS2229	FS2230	

★ New addition to range

Hydraulic expansion chuck MAS-BT JIS B 6339 AK 182.BT ...

SK40 + SK50



- For tools with shank in acc. with DIN 1835

Tool	Designation	d ₁ mm	d ₁₁ mm	d ₁₂ mm	l ₄ mm	d ₁₄ mm	l ₁₆ mm	l ₁₇ mm	l _{17min} mm	kg
JIS 6339	★ AK182.BT40.058.12	SK40	12	42	58	32	31	46	36	1,2
	★ AK182.BT40.072.20	SK40	20	49,25	72	38	45,5	51	41	1,4
	★ AK182.BT50.084.20	SK50	20	49,25	84	38	45,5	51	41	4,1
	★ AK182.BT50.090.32	SK50	32	72	90	58,5	52	61	51	4,6

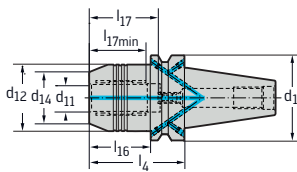

Bodies and assembly parts are included in the scope of delivery.

For pull studs for steep tapers, see page H 42 of the Walter General catalogue 2012.

Accessories

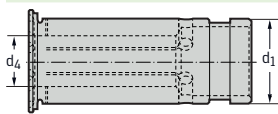

	d ₄ mm	3	4	5	6	7	8	9	10	11
Adaptor sleeves for peripheral cooling	d ₁ = 12 mm	FS2194	FS2195	FS2196	FS2197	-	FS2198	-	-	-
	d ₁ = 20 mm	FS2213	FS2214	FS2215	FS2216	-	FS2217	-	FS2218	-
	d ₁ = 32 mm	-	-	-	FS2231	-	FS2232	-	FS2233	-
Adaptor sleeves sealed for internal cooling	d ₁ = 12 mm	FS2189	FS2190	FS2191	FS2192	-	FS2193	-	-	-
	d ₁ = 20 mm	FS2199	FS2200	FS2201	FS2202	FS2203	FS2204	FS2205	FS2206	FS2207
	d ₁ = 32 mm	-	-	-	FS2222	-	FS2223	-	FS2224	-
Continued	d₄ mm	12	13	14	15	16	18	20	25	
Adaptor sleeves for peripheral cooling	d ₁ = 12 mm	-	-	-	-	-	-	-	-	-
	d ₁ = 20 mm	FS2219	-	FS2220	-	FS2221	-	-	-	-
	d ₁ = 32 mm	FS2234	-	FS2235	-	FS2236	FS2237	FS2238	FS2239	-
Adaptor sleeves sealed for internal cooling	d ₁ = 12 mm	-	-	-	-	-	-	-	-	-
	d ₁ = 20 mm	FS2208	FS2209	FS2210	FS2211	FS2212	-	-	-	-
	d ₁ = 32 mm	FS2225	-	FS2226	-	FS2227	FS2228	FS2229	FS2230	-

★ New addition to range

Collet chuck DIN 69871 AD+B

AK 300.S ...

SK40 + SK50

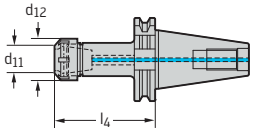

- For ER collets in acc. with DIN 6499

Tool	Designation	d ₁ mm	d ₁₁ mm	d ₁₂ mm	l ₄ mm	Collets	
SK DIN 69871 AD+B 	★ AK300.S40.075.ER16	SK40	1-10	28	75	ER 16	1
	★ AK300.S40.075.ER20	SK40	1-13	34	75	ER 20	1,1
	★ AK300.S40.075.ER25	SK40	1-16	42	75	ER 25	1,3
	★ AK300.S40.075.ER32	SK40	1-20	50	75	ER 32	1,4
	★ AK300.S40.075.ER40	SK40	2-26	63	75	ER 40	1,6
	★ AK300.S40.105.ER16	SK40	1-10	28	105	ER 16	1,1
	★ AK300.S40.105.ER20	SK40	1-13	34	105	ER 20	1,3
	★ AK300.S40.105.ER25	SK40	1-16	42	105	ER 25	1,7
	★ AK300.S40.105.ER32	SK40	1-20	50	105	ER 32	1,8
	★ AK300.S40.105.ER40	SK40	2-26	63	105	ER 40	2
	★ AK300.S50.075.ER20	SK50	1-13	34	75	ER 20	2,9
	★ AK300.S50.075.ER25	SK50	1-16	42	75	ER 25	3,2
	★ AK300.S50.075.ER32	SK50	1-20	50	75	ER 32	3,3
	★ AK300.S50.075.ER40	SK50	2-26	63	75	ER 40	3,3
	★ AK300.S50.105.ER20	SK50	1-13	34	105	ER 20	3,1
	★ AK300.S50.105.ER25	SK50	1-16	42	105	ER 25	3,4
	★ AK300.S50.105.ER32	SK50	1-20	50	105	ER 32	3,7
	★ AK300.S50.105.ER40	SK50	2-26	63	105	ER 40	4,1

Bodies and assembly parts are included in the scope of delivery.

If the collet chuck is used for the internal coolant supply, use the sealing discs on page G 102 of the Walter General catalogue 2012.

The clamping nut can be damaged if the chuck is used without a sealing disc.

For collets, see page G 99 of the Walter General catalogue 2012.

For pull studs for steep tapers, see page H 42 of the Walter General catalogue 2012.

Assembly parts		ER 16	ER 20	ER 25	ER 32	ER 40
	Collets Clamping nut for internal coolant supply	FS1448	FS1359	FS1449	FS1360	FS1450

Accessories		ER 16-ER 20	ER 25	ER 32	ER 40
	Collets Tensioning key	FS1539	FS1544	FS1545	FS1546

★ New addition to range

Collet chuck MAS-BT JIS B 6339

AK 300.BT ...

SK40 + SK50



- For ER collets in acc. with DIN 6499

Tool	Designation	d ₁ mm	d ₁₁ mm	d ₁₂ mm	l ₄ mm	Collets	kg
JIS B 6339 	★ AK300.BT40.075.ER16	SK40	1-10	28	75	ER 16	1,1
	★ AK300.BT40.075.ER20	SK40	1-13	34	75	ER 20	1,2
	★ AK300.BT40.075.ER25	SK40	1-16	42	75	ER 25	1,4
	★ AK300.BT40.075.ER32	SK40	1-20	50	75	ER 32	1,5
	★ AK300.BT40.075.ER40	SK40	2-26	63	75	ER 40	1,6
	★ AK300.BT40.105.ER16	SK40	1-10	28	105	ER 16	1,3
	★ AK300.BT40.105.ER20	SK40	1-13	34	105	ER 20	1,5
	★ AK300.BT40.105.ER25	SK40	1-16	42	105	ER 25	1,7
	★ AK300.BT40.105.ER32	SK40	1-20	50	105	ER 32	1,8
	★ AK300.BT40.105.ER40	SK40	2-26	63	105	ER 40	1,9
	★ AK300.BT50.075.ER20	SK50	1-13	34	75	ER 20	3,7
	★ AK300.BT50.075.ER25	SK50	1-16	42	75	ER 25	4
	★ AK300.BT50.075.ER32	SK50	1-20	50	75	ER 32	4
	★ AK300.BT50.085.ER40	SK50	2-26	63	75	ER 40	4,2
	★ AK300.BT50.105.ER20	SK50	1-13	34	105	ER 20	4,1
	★ AK300.BT50.105.ER25	SK50	1-16	42	105	ER 25	4,3
	★ AK300.BT50.105.ER32	SK50	1-20	50	105	ER 32	4,5
	★ AK300.BT50.105.ER40	SK50	2-26	63	105	ER 40	4,9

Bodies and assembly parts are included in the scope of delivery.

If the collet chuck is used for the internal coolant supply, use the sealing discs on page G 102 of the Walter General catalogue 2012.

The clamping nut can be damaged if the chuck is used without a sealing disc.

For collets, see page G 99 of the Walter General catalogue 2012.

For pull studs for steep tapers, see page H 42 of the Walter General catalogue 2012.

Assembly parts		Collets	ER 16	ER 20	ER 25	ER 32	ER 40
	Clamping nut for internal coolant supply		FS1448	FS1359	FS1449	FS1360	FS1450

Accessories		Collets	ER 16-ER 20	ER 25	ER 32	ER 40
	Tensioning key		FS1539	FS1544	FS1545	FS1546

★ New addition to range

Collet chuck DIN 69871 AD+B

AK 300.S ...

SK40 + SK50

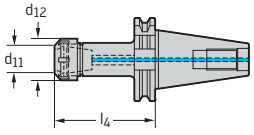

- For ER collets in acc. with DIN 6499

Tool	Designation	d ₁ mm	d ₁₁ mm	d ₁₂ mm	l ₄ mm	Collets	
SK DIN 69871 AD+B 	★ AK300.S40.070.ER16	SK40	1-10	28	70	ER 16	1
	★ AK300.S40.070.ER20	SK40	1-13	34	70	ER 20	1,1
	★ AK300.S40.070.ER25	SK40	1-16	42	70	ER 25	1,2
	★ AK300.S40.070.ER32	SK40	1-20	50	70	ER 32	1,4
	★ AK300.S40.070.ER40	SK40	2-26	63	70	ER 40	1,5
	★ AK300.S40.100.ER16	SK40	1-10	28	100	ER 16	1,1
	★ AK300.S40.100.ER20	SK40	1-13	34	100	ER 20	1,3
	★ AK300.S40.100.ER25	SK40	1-16	42	100	ER 25	1,5
	★ AK300.S40.100.ER32	SK40	1-20	50	100	ER 32	1,8
	★ AK300.S40.100.ER40	SK40	2-26	63	100	ER 40	1,9
	★ AK300.S50.070.ER20	SK50	1-13	34	70	ER 20	2,9
	★ AK300.S50.070.ER25	SK50	1-16	42	70	ER 25	3,2
	★ AK300.S50.070.ER32	SK50	1-20	50	70	ER 32	3,1
	★ AK300.S50.070.ER40	SK50	2-26	63	70	ER 40	3,5
	★ AK300.S50.100.ER20	SK50	1-13	34	100	ER 20	3,1
	★ AK300.S50.100.ER25	SK50	1-16	42	100	ER 25	3,6
	★ AK300.S50.100.ER32	SK50	1-20	50	100	ER 32	3,8
	★ AK300.S50.100.ER40	SK50	2-26	63	100	ER 40	4,1

Bodies and assembly parts are included in the scope of delivery.

For collets, see page G 99 of the Walter General catalogue 2012.

For pull studs for steep tapers, see page H 42 of the Walter General catalogue 2012.

Assembly parts		ER 16	ER 20	ER 25	ER 32	ER 40
	Collets Clamping nut	FS1537	FS2183	FS1540	FS1541	FS1542

Accessories		ER 16-ER 20	ER 25	ER 32	ER 40
	Collets Tensioning key	FS1539	FS1544	FS1545	FS1546

★ New addition to range

Collet chuck MAS-BT JIS B 6339

AK 300.BT ...

SK40 + SK50



- For ER collets in acc. with DIN 6499

Tool	Designation	d ₁ mm	d ₁₁ mm	d ₁₂ mm	l ₄ mm	Collets	kg
JIS B 6339 	★ AK300.BT40.070.ER16	SK40	1-10	28	70	ER 16	1,1
	★ AK300.BT40.070.ER20	SK40	1-13	34	70	ER 20	1,1
	★ AK300.BT40.070.ER25	SK40	1-16	42	70	ER 25	1,3
	★ AK300.BT40.070.ER32	SK40	1-20	50	70	ER 32	1,4
	★ AK300.BT40.070.ER40	SK40	2-26	63	70	ER 40	1,6
	★ AK300.BT40.100.ER16	SK40	1-10	28	100	ER 16	1,3
	★ AK300.BT40.100.ER20	SK40	1-13	34	100	ER 20	1,5
	★ AK300.BT40.100.ER25	SK40	1-16	42	100	ER 25	1,7
	★ AK300.BT40.100.ER32	SK40	1-20	50	100	ER 32	1,8
	★ AK300.BT40.100.ER40	SK40	2-26	63	100	ER 40	1,9
	★ AK300.BT50.070.ER20	SK50	1-13	34	70	ER 20	3,7
	★ AK300.BT50.070.ER25	SK50	1-16	42	70	ER 25	4
	★ AK300.BT50.070.ER32	SK50	1-20	50	70	ER 32	4
	★ AK300.BT50.080.ER40	SK50	2-26	63	70	ER 40	4,2
	★ AK300.BT50.100.ER20	SK50	1-13	34	100	ER 20	4,1
	★ AK300.BT50.100.ER25	SK50	1-16	42	100	ER 25	4,3
	★ AK300.BT50.100.ER32	SK50	1-20	50	100	ER 32	4,5
	★ AK300.BT50.100.ER40	SK50	2-26	63	100	ER 40	4,9

Bodies and assembly parts are included in the scope of delivery.

For collets, see page G 99 of the Walter General catalogue 2012.

For pull studs for steep tapers, see page H 42 of the Walter General catalogue 2012.

Assembly parts		ER 16	ER 20	ER 25	ER 32	ER 40
	Collets Clamping nut	FS1537	FS2183	FS1540	FS1541	FS1542

Accessories		ER 16-ER 20	ER 25	ER 32	ER 40
	Collets Tensioning key	FS1539	FS1544	FS1545	FS1546

★ New addition to range

Tightening screws for face mill adaptors

When using face mill adaptors A150, A155 and AK155 in combination with porcupine cutters and ramping milling cutters with cylindrical bores and DIN 138 longitudinal key way, the tightening screw of the adaptor must be replaced.

Designation	Tightening screw for adaptor*
F4138.B16.040.Z03.33	M8 x 40 (SW6)
F4138.B16.040.Z03.43	M8 x 50 (SW6)
F4138.B22.050.Z04.43	M10 x 45 (SW8)
F4138.B22.050.Z04.54	M10 x 55 (SW8)
F4138.B27.063.Z05.43	M12 x 45 (SW10)
F4138.B27.063.Z05.54	M12 x 55 (SW10)
F4138.B32.080.Z06.54	M16 x 65 (SW14)
F4138.B32.080.Z06.65	M16 x 70 (SW14)
F4238.B22.050.Z03.43	M10 x 45 (SW8)
F4238.B27.063.Z04.43	M12 x 55 (SW10)
F4238.B27.063.Z04.57	M12 x 70 (SW10)
F4238.B27.066.Z04.57	M12 x 70 (SW10)
F4238.B32.080.Z05.57	M16 x 70 (SW14)
F4238.B32.080.Z05.71	M16 x 90 (SW14)
F4238.B32.085.Z05.71	M16 x 90 (SW14)
F4338.B27.063.Z04.31	M12 x 40 (SW10)
F4338.B27.063.Z04.47	M12 x 50 (SW10)
F4338.B27.063.Z04.63	M12 x 65 (SW10)
F4338.B32.080.Z05.31	M16 x 35 (SW14)
F4338.B32.080.Z05.63	M16 x 70 (SW14)
F4338.B32.080.Z05.78	M16 x 90 (SW14)
F4338.B40.100.Z05.78	M20 x 80 (SW17)
F4338.B40.125.Z06.94	M20 x 90 (SW17)

Designation	Tightening screw for adaptor*
F5138.B22.040.Z02.34	M10 x 40 (SW8)
F5138.B22.040.Z02.45	M10 x 45 (SW8)
F5138.B22.050.Z03.34	M10 x 40 (SW8)
F5138.B22.050.Z03.45	M10 x 45 (SW8)
F5138.B27.063.Z04.45	M12 x 50 (SW10)
F5138.B27.063.Z04.56	M12 x 60 (SW10)
F5138.B32.080.Z05.56	M16 x 65 (SW14)
F2238.B.050.Z02.42	M10 x 40 (SW8)
F2238.B.063.Z03.50	M12 x 35 (SW10)
F2238.B.065.Z03.50	M12 x 35 (SW10)
F2238.B.080.Z03.67	M16 x 60 (SW14)
F2238.B.082.Z03.67	M16 x 60 (SW14)
F2238.B.100.Z04.77	M20 x 70 (SW17)
F2238.B.125.Z05.87	M24 x 80 (SW19)
F3040.B.040.Z03.15	M8 x 40 (SW6)
F3040.B.050.Z04.15	M10 x 35 (SW8)
F3040.B.063.Z05.15	M10 x 35 (SW8)
F3040.B.050.Z03.20	M10 x 40 (SW8)
F3040.B.063.Z04.20	M10 x 35 (SW8)

* Cap screw ISO 4762 (12.9)

Recommended ap [mm] limits for hydraulic expansion chuck AK 182

D _C [mm]	Adaptor in the hydraulic expansion chuck	12 mm			16 mm		20 mm	
		AK 182 ... 12 direct	AK 182 ... 20 reduced	AK 182 ... 32 reduced	AK 182 ... 20 reduced	AK 182 ... 32 reduced	AK 182 ... 20 direct	AK 182 ... 32 reduced
P	ISO-P	10	15	30	10	25	10	20
M	ISO-M	10	13	30	10	30	10	23
K	ISO-K	12	18	40	12	30	10	28
N	Aluminium	30	40	40	40	40	16	40
S	Inconel	8	12	27	10	23	8	18



CONTENTS

General

	Page
General technical information	
Screwdrivers	H-2
Clamping screws for indexable inserts	H-4
Calculation formulae for turning	H-5
Calculation formulae for drilling	H-6
Calculation formulae for milling	H-7
Milling engagement conditions	H-8
Calculation formulae for thread machining	H-9
Clamping systems for tools and tool adaptors	H-10
Alphanumeric Index	H-17

Torque screwdriver with interchangeable blades



Torque screwdriver



Designation	Size		Scale range
FS 2001	1	4	0.4–1.2 Nm
FS 2003	3	4	1.5–5.0 Nm
FS 2002	1	4	3.5–10.6 in lbs
FS 2004	3	4	13.3–44 in lbs







Designation	Size		Scale range
FS 2248		4	1.0–6.0 Nm

Interchangeable blades	Designation	Torx	
 Torx interchangeable blades Blade length 175 mm	FS 2005	6	4
	FS 2006	7	
	FS 2007	8	
	FS 2008	10	
	FS 2009	15	
	FS 2010	20	
 Torx Plus interchangeable blades Blade length 175 mm	FS 2085	6 IP	4
	FS 2011	7 IP	
	FS 2012	8 IP	
	FS 2013	9 IP	
	FS 2014	15 IP	
	FS 2015	20 IP	
	FS 2016	25 IP	
Complete blade set (FS 2005–FS 2016) Blade length 175 mm	FS 2017		4

Torque T-handle



Designation		Scale range
FS 2041	6	4.5–14 Nm
FS 2042	6	40–123 in lbs

Interchangeable blades	Designation	Torx / SW	
 Torx interchangeable blades Blade length 130 mm	FS 2043	15	6
	FS 2044	20	
	FS 2045	25	
	FS 2046	30	
 Torx Plus interchangeable blades Blade length 130 mm	FS 2047	15 IP	6
	FS 2048	20 IP	
	FS 2049	25 IP	
	FS 2109	30 IP	
 Hexagonal interchangeable blades Blade length 130 mm	FS 2050	SW 3	6
	FS 2051	SW 4	
	FS 2052	SW 5	
Complete blade set (FS 2043–FS 2052) Blade length 130 mm	FS 2053		6

Screwdriver

Screwdriver types	Designation	Torx
 Screwdriver	FS 1063	6
	FS 2086	6 IP
	FS 309	7
	FS 2088	7 IP
	FS 230	8
	FS 1483	8 IP
	FS 1128	9
	FS 1484	9 IP
	FS 229	15
	FS 1485	15 IP
	FS 228	20
	FS 1486	20 IP
	FS 2167	25
	FS 1487	25 IP
	FS 396	30
	FS 2109	30 IP

IP = Torx Plus

Screwdriver types	Designation	Torx	SW	
 Torx key	FS 2146	6 IP	-	
	FS 2087	6 IP	-	
	FS 325	7	-	
	FS 1490	7 IP	-	
	FS 257	8	-	
	FS 1466	9 IP	-	
	FS 1050	10	-	
	FS 255	15	-	
	FS 1465	15 IP	3,5	
	FS 1496	15 IP	4,0	
	FS 256	20	-	
	FS 1154	-	2,0	
	FS 1155	-	2,5	



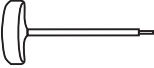

IP = Torx Plus

Screwdriver types	Designation	Torx
 Handle key, small	FS 1047	15
	FS 1048	20
	FS 1049	25
 Handle key, large	FS 1172	15
	FS 1173	20
	FS 1174	25
	FS 1175	30

Allen key	Designation	Torx	SW	
	ISO 2936-1,3	-	1,3	
	ISO 2936-1,5	-	1,5	
	ISO 2936-2	-	2	
	ISO 2936-2,5	-	2,5	
	ISO 2936-3	-	3	
	ISO 2936-4	-	4	
	ISO 2936-5	-	5	
	ISO 2936-6	-	6	
	FS 1464	20 IP	-	
	FS 1592	25 IP	-	

IP = Torx Plus

Clamping Screws for Indexable Inserts

Screw types	Designation	Dimensions	Tightening torque		
			Torx	Nm	
 Clamping screws with head angle 43° for inserts with countersink	FS 322	M 2,5 x 5,7	7	0,8	
	FS 258	M 3 x 5,7	8	1,5	
	FS 246	M 3 x 7	8	1,5	
	FS 1163	M 3,5 x 10	15	3,0	
	FS 320	M 4 x 5	15	3,0	
	FS 318	M 4 x 6	15	3,0	
	FS 245	M 4 x 6,5	15	3,0	
	FS 321	M 4 x 7	15	3,0	
	FS 319	M 4 x 8	15	3,0	
	FS 244	M 4 x 9	15	3,0	
	FS 749	M 4 x 10,5	15	3,0	
	FS 326	M 4 x 12	15	3,0	
	FS 1458	M 4 x 11,3	15 IP	2,5	
	FS 954	M 4,5 x 11	20	4,5	
	FS 260	M 5 x 9,5	20	5,0	
	FS 243	M 5 x 11	20	5,0	
	FS 242	M 5 x 13	20	5,0	
	FS 1165	M 5 x 12	20	6,0	
	FS 1010	M 6 x 14	20	5,0	
	FS 1164	M 6 x 15	25	10,0	
 Fitting screws	FS 925	M 2,5 x 6,5	8	0,8	
	FS 397	M 3 x 6,9	8	1,0	
	FS 2070	M 3 x 6,5	8 IP	2,0	
	FS 922	M 3,5 x 9,5	15	2,5	
	FS 390	M 4 x 0,5 x 8,4	15	4,0	
	FS 2071	M 4 x 8,4	15 IP	4,0	
	FS 1028	M 4,5 x 12,8	20	4,0	
	FS 1153	M 4,5 x 14	20	4,0	
	FS 391	M 5 x 0,5 x 9,1	20	5,0	
	FS 392	M 5 x 0,5 x 12,75	20	5,0	
	FS 393	M 5 x 0,5 x 15,45	20	5,0	
	FS 2072	M 5 x 9,55	20 IP	5,0	
	FS 2073	M 5 x 0,5 x 12,75	20 IP	5,0	
	FS 2074	M 5 x 15,45	20 IP	5,0	
	FS 2075	M 6 x 20,35	20 IP	5,0	
	FS 394	M 6 x 0,7 x 20,35	20	5,0	
	FS 395	M 8 x 0,75 x 24,7	30	6,0	
	FS 2107	M 8 x 24,7	30 IP	10,0	
	 Clamping screws for exchangeable blades	FS 1396	M 2,5 x 10,9	7 IP	1,2
		FS 1397	M 3 x 12,8	8 IP	2,0
FS 1398		M 3 x 14,7	8 IP	2,0	
FS 1399		M 4 x 16,7	15 IP	4,0	
FS 1400		M 5 x 18,7	20 IP	5,0	
FS 1401		M 5 x 20,6	20 IP	5,0	
FS 1402		M 5 x 22,6	20 IP	5,0	
FS 1403		M 6 x 24,6	25 IP	5,5	
FS 1404		M 6 x 26,6	25 IP	5,5	
FS 2159		M 6 x 29,6	25 IP	5,5	
 Clamping screws for thread milling inserts with head angle 60° and arched countersink in accordance with ISO	T9111010-1XT7	M 2,2 x 5	7	0,4	
	T9111020-2XT8	M 2,6 x 6,5	8	1,0	
	T9111030-3XT10	UNC 5 x 9,5	10	1,5 / 2,0	
	T9111031-3MXT10	UNC 5 x 8	10	1,5 / 2,0	
	T9111040-4XT20	UNC 8 x 10,7	20	5,0	
	T9111050-5XT25	M 5 x 15	25	6,0	

Screw types	Designation	Dimensions	Tightening torque	
			Torx	Nm
 Clamping screws with head angle 60° for inserts with arched countersink in acc. with ISO	FS 1358	M 1,8 x 3,5	6	0,4
	FS 1012	M 1,8 x 4,3	6	0,4
	FS 2076	M 2 x 3,2	6 IP	0,6
	FS 1003	M 2 x 3,25	6	0,4
	FS 1151	M 2 x 3,45	6	0,4
	FS 2147	M 2 x 4,25	6 IP	0,6
	FS 2148	M 2 x 4,95	6 IP	0,6
	FS 1004	M 2,2 x 4,6	7	0,6
	FS 2084	M 2,2 x 4,6	7 IP	0,9
	FS 2111	M 2,2 x 4,85	7 IP	0,9
	FS 1020	M 2,2 x 5,5	7	0,6
	FS 2149	M 2,2 x 6,4	7 IP	0,9
	FS 2066	M 2,5 x 5,2	7 IP	0,9
	FS 924	M 2,5 x 4,5	8	0,8
	FS 1455	M 2,5 x 4,5	8 IP	0,8 / 1,2
	FS 1129	M 2,5 x 5,2	8	0,8
	FS 1021	M 2,5 x 5,5	8	0,8
	FS 2067	M 2,5 x 5,7	7 IP	0,9
	FS 375	M 2,5 x 5,8	7	0,8
	FS 923	M 2,5 x 6	8	0,8 / 1,2
	FS 1454	M 2,5 x 6	8 IP	0,8 / 1,2
	FS 2061	M 2,5 x 6,5	7 IP	0,9
	FS 2077	M 3 x 5,3	9 IP	1,5
	FS 1005	M 3 x 6	8	1,0
	FS 1456	M 3 x 6,2	9 IP	1,5 / 2,0
	FS 2078	M 3 x 7,2	9 IP	1,5
	FS 1013	M 3 x 7,5	8	1,0
	FS 1457	M 3 x 7,7	9 IP	1,5
	FS 379	M 3 x 8,5	8	1,0
	FS 2079	M 3 x 8,7	9 IP	2,0
	FS 920	M 3,5 x 7,3	15	2,5
	FS 2062	M 3,5 x 8,1	15 IP	3,0
	FS 359	M 3,5 x 9	15	2,5
	FS 2119	M 3,5 x 9,3	15 IP	3,0
	FS 2063	M 3,5 x 10,1	15 IP	3,0
	FS 1006	M 3,5 x 12	15	2,5
	FS 2060	M 3,5 x 12,1	15 IP	3,0
	FS 2064	M 4 x 0,5 x 11	15 IP	3,0
	FS 2065	M 4 x 0,5 x 14	15 IP	3,0
	FS 1011	M 4 x 7,8	15	3,0
FS 2080	M 4 x 8,5	15 IP	2,5	
FS 2114	M 4 x 9	15 IP	2,5	
FS 378	M 4 x 9,5	15	3,0	
FS 1453	M 4 x 9,7	15 IP	2,5 / 3,5	
FS 1459*	M 4 x 10	15 IP	4,0	
FS 2163	M 4 x 10,8	15 IP	3,0	
FS 2081	M 4 x 12	15 IP	3,0	
FS 1007	M 4 x 12	15	3,0	
FS 1029	M 5 x 9	20	5,0	
FS 2139	M 5 x 10	20 IP	5,0	
FS 1030	M 5 x 11	20	5,0	
FS 1495	M 5 x 13	20 IP	5,0	
FS 1031	M 5 x 13	20	5,0	
FS 1009	M 5 x 16	20	5,0	
FS 2112	M 5 x 16	20 IP	5,0	
FS 2090	M 5 x 17,25	20 IP	5,0	
FS 1036	M 6 x 14	20	5,0	
FS 2089	M 6 x 18,25	25 IP	5,0	
FS 1008	M 6 x 18	20	5,0	
FS 1152	M 8 x 1 x 18,5	30	10,0	
FS 2150	M 8 x 22	30 IP	10,0	

* Screw head with radius

IP = Torx Plus

Calculations formulae for turning

Speed

$$n = \frac{v_c \times 1000}{D_c \times \pi} \quad [\text{min}^{-1}]$$

Cutting speed

$$v_c = \frac{D_c \times \pi \times n}{1000} \quad [\text{m/min}]$$

Feed rate

$$v_f = n \times f \quad [\text{mm/min}]$$

Metal removal rate

$$Q = v_c \times a_p \times f \quad [\text{cm}^3/\text{min}]$$

Chip cross section

$$A = h \times b = a_p \times f \quad [\text{mm}^2]$$

Chip width, chip thickness

$$b = \frac{a_p}{\sin \kappa} \quad [\text{mm}] \quad h = f \times \sin \kappa \quad [\text{mm}]$$

Main cutting force

$$F_c = A \times k_{c1.1} \times h^{-m_c} \quad [\text{N}]$$

Power requirement

$$P_{\text{mot}} = \frac{F_c \times v_c}{60000 \times \eta} \quad [\text{kW}]$$

Cutting time

$$t_h = \frac{l_m}{f \times n} \quad [\text{min}]$$

Roughness profile depth

$$R_{\text{max}} = \frac{f^2}{8 \times r} \times 1000 \quad [\mu\text{m}]$$

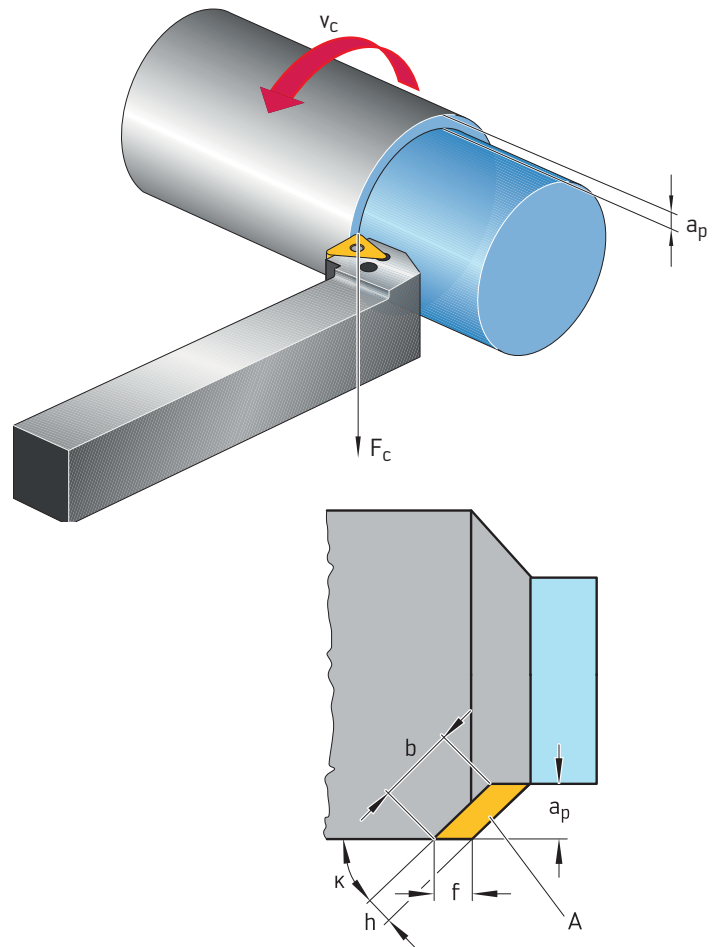

n	Speed	rpm
D _c	Turning diameter	mm
v _c	Cutting speed	m/min
v _f	Feed rate	mm/min
f	Feed per revolution	mm
Q	Metal removal rate	cm ³ /min
a _p	Depth of cut	mm
A	Chip cross section	mm ²
h	Chip thickness	mm
b	Chip width	mm
κ	Lead angle	°
F _c	Main cutting power	N
k _{c1.1} *	Specific cutting force for 1 mm ² chip cross section	N/mm ²
m _c *	Increase in the k _c curve	
P _{mot}	Drive power	kW
t _h	Cutting time	min
l _m	Length of cut	mm
R _{max}	Roughness profile depth	μm
r	Corner radius of the insert	mm
η	Efficiency of the machine	0.75 – 0.9)

* m_c and k_{c1.1} see table on page H 7 in the Walter General catalogue 2012.

Drilling calculation formulae

Speed

$$n = \frac{v_c \times 1000}{D_c \times \pi} \quad [\text{min}^{-1}]$$

Cutting speed

$$v_c = \frac{D_c \times \pi \times n}{1000} \quad [\text{m/min}]$$

Feed per revolution

$$f = f_z \times z \quad [\text{mm}]$$

Feed rate

$$v_f = f \times n \quad [\text{mm/min}]$$

Metal removal rate (drilling)

$$Q = \frac{v_f \times \pi \times D_c^2}{4 \times 1000} \quad [\text{cm}^3/\text{min}]$$

Power requirement

$$P_{\text{mot}} = \frac{Q \times k_c}{60000 \times \eta} \quad [\text{kW}]$$

Torque

$$M_c = \frac{D_c^2 \times k_c \times f}{8000} = \frac{P_c \times 9500}{n} \quad [\text{Nm}]$$

Feed force

$$F_f = 0,63 \times \frac{f \times D_c \times k_c}{2} \quad [\text{N}]$$

Specific cutting force

$$k_c = \frac{k_{c1.1}}{h^{m_c}}$$

Chip thickness

$$h = f_z \times \sin \kappa \quad [\text{mm}]$$

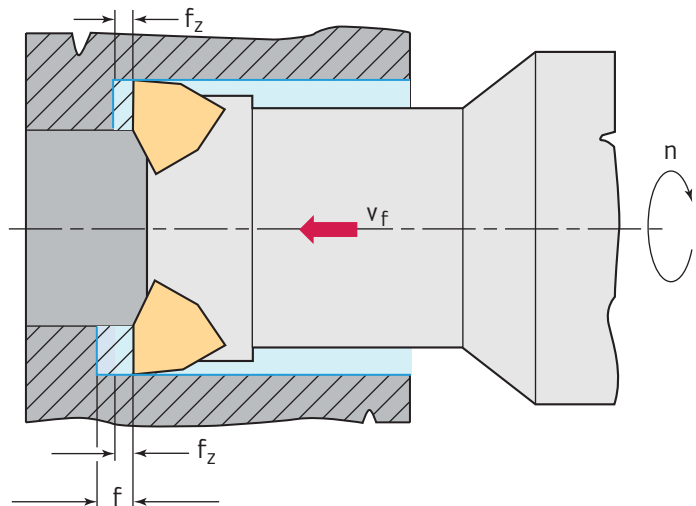
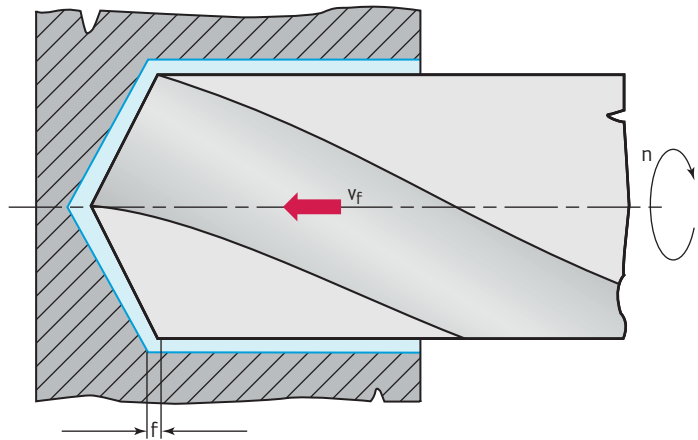

n	Speed	rpm
D _c	Cutter diameter	mm
z	Number of teeth	
v _c	Cutting speed	m/min
v _f	Feed rate	mm/min
f _z	Feed per tooth	mm
f	Feed per revolution	mm
A	Chip cross section	mm ²
Q	Metal removal rate	cm ³ /min
P _{mot}	Drive power	kW
M _c	Torque	Nm
F _f	Axial force	N
h	Chip thickness	mm
k _c	Specific cutting force	N/mm ²
η	Efficiency of the machine (0.7 – 0.95)	
κ	Lead angle	°
k _{c1.1} *	Specific cutting force for 1 mm ² chip cross section with h = 1 mm	N/mm ²
m _c *	Increase in the k _c curve	

* m_c and k_{c1.1} see table on page H 7 in the Walter General catalogue 2012.

Milling calculation formulae

Speed

$$n = \frac{v_c \times 1000}{D_c \times \pi} \quad [\text{min}^{-1}]$$

Cutting speed

$$v_c = \frac{D_c \times \pi \times n}{1000} \quad [\text{m/min}]$$

Feed rate

$$v_f = f_z \times z \times n \quad [\text{mm/min}]$$

Feed per tooth

$$f_z = \frac{v_f}{z \times n} \quad [\text{mm/z}]$$

Metal removal rate

$$Q = \frac{a_e \times a_p \times v_f}{1000} \quad [\text{cm}^3/\text{min}]$$

Power requirement

$$P_{\text{mot}} = \frac{a_p \times a_e \times v_f \times k_c}{6 \times 10^7 \times \eta} \quad [\text{kW}]$$

Medium chip thickness

$$h_m = \frac{\{114,7 \times f_z \times \sin \kappa \times (a_e / D_c)\}}{\varphi_s} \quad [\text{mm}]$$

$$f_z = \frac{h_m \times \varphi_s}{114,7 \times \sin \kappa \times (a_e / D_c)} \quad [\text{mm}]$$

or

$$h_m \cong f_z \times \sqrt{\frac{a_e}{D_c}} \quad [\text{mm}]$$

$$f_z = \frac{h_m}{\sqrt{\frac{a_e}{D_c}}} \quad [\text{mm}]$$

as approximation formula for $a_e/D_c < 30\%$

Cutting angle

where milling cutter is positioned centrally

$$\varphi_s = 2 \times \arcsin \left(\frac{a_e}{D_c} \right) \quad [^\circ]$$

where milling cutter is positioned eccentrically

$$\varphi_s = 90^\circ + \arcsin \frac{a_e - (D_c/2)}{(D_c/2)} \quad [^\circ]$$

Specific cutting force

$$k_c = \frac{1 - 0,01 \times \gamma_0}{h_m^{m_c}} \times k_{c1.1} \quad [\text{N/mm}^2]$$

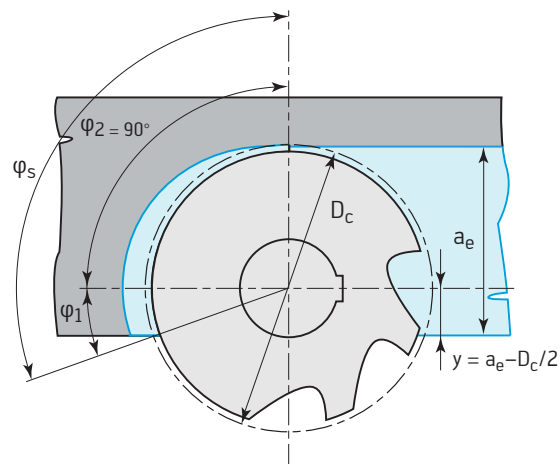
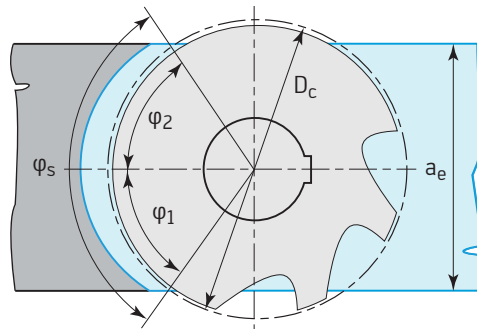
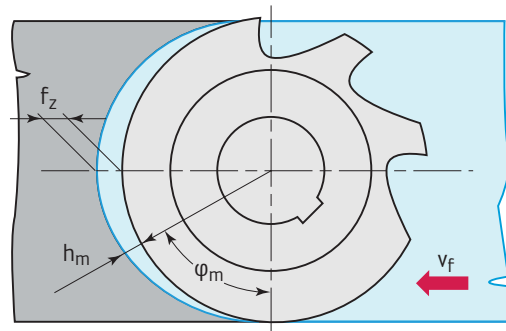

n	Speed	rpm
D _c	Cutter diameter	mm
a _p	Depth of cut	mm
a _e	Width of cut	mm
z	Number of teeth	
v _c	Cutting speed	m/min
v _f	Feed rate	mm/min
f _z	Feed per tooth	mm
Q	Metal removal rate	cm ³ /min
P _{mot}	Drive power	kW
h _m	Medium chip thickness	mm
k _c	Specific cutting force	N/mm ²
η	Machine efficiency (0.7 – 0.95)	
κ	Lead angle	°
φ _s	Cutting angle	°
φ ₁	Up-cut milling area	°
φ ₂	Synchronous milling area	°
k _c	Specific cutting force	N/mm ²
k _{c1.1} *	Specific cutting force for 1 mm ² chip cross section	N/mm ²
m _c *	Increase in the k _c curve	
y	Reverse cutting	mm

* For m_c and k_{c1.1}, see table on page H 7 in the Walter General catalogue 2012.

Cutting ratio for external circular interpolation

External contour

$$v_{fa} = \left(1 + \frac{D_c}{D_w + a_e}\right) \times v_f \quad [\text{mm/min}]$$

Circular interpolation milling circulation time

$$T_{rev} = \frac{D_m \times \pi}{n \times f_z \times z} \quad [\text{min}]$$

$$T_{rev} = \frac{(D_w + D_a) D_a \times \pi^2 \times 60}{v_c \times f_z \times z \times 1000} \quad [\text{s}]$$

Cutting width with external circular interpolation milling

$$a_e = \frac{(D_v^2 - D_w^2)}{4(D_w + D_a)} \quad [\text{mm}]$$

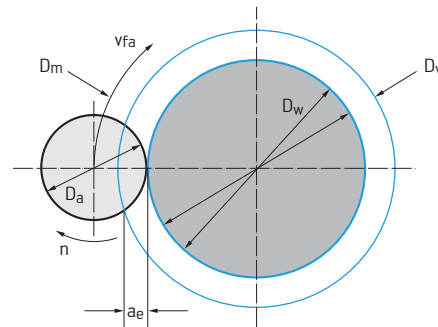

External contour

v_{fa}	Feed rate of tool axis	[mm/min]
D_a	Milling cutter outer diameter	[mm]
D_m	Mid-point path diameter	[mm]
D_v	Workpiece raw diameter	[mm]
D_w	Workpiece machined diameter	[mm]
a_e	Material removal	[mm]
n	Speed	[rpm]
f_z	Feed per tooth	[mm]
z	Number of teeth	

Cutting ratio for internal circular interpolation milling of holes

Internal contour

$$v_{fi} = \left(1 - \frac{D_c}{D_w}\right) \times v_f \quad [\text{mm/min}]$$

Circular interpolation milling circulation time

$$T_{rev} = \frac{D_m \times \pi}{n \times f_z \times z} \quad [\text{min}]$$

$$T_{rev} = \frac{(D_w - D_a) D_a \times \pi^2 \times 60}{v_c \times f_z \times z \times 1000} \quad [\text{s}]$$

Cutting width with circular interpolation milling

$$a_e = \frac{(D_w^2 - D_v^2)}{4(D_w + D_a)} \quad [\text{mm}]$$

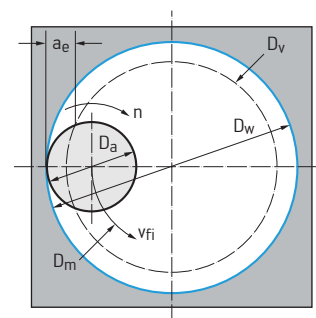

Internal contour

v_{fi}	Feed rate of tool axis	[mm/min]
D_a	Milling cutter diameter	[mm]
D_v	Workpiece raw diameter	[mm]
D_w	Workpiece machined diameter	[mm]
n	Speed	[rpm]

Thread machining calculation formulae

Speed

$$n = \frac{v_c \times 1000}{D_c \times \pi} \quad [\text{min}^{-1}]$$

Cutting speed

$$v_c = \frac{D_c \times \pi \times n}{1000} \quad [\text{m/min}]$$

Torque

$$M_D = \frac{k_c \times h^2 \times d_1}{8000} \quad [\text{Nm}]$$

Power at the tap

$$P = \frac{M_D \times n}{9500} \quad [\text{kW}]$$

Power requirement

$$P_{\text{mot}} = \frac{P}{\eta_M} \quad [\text{kW}]$$

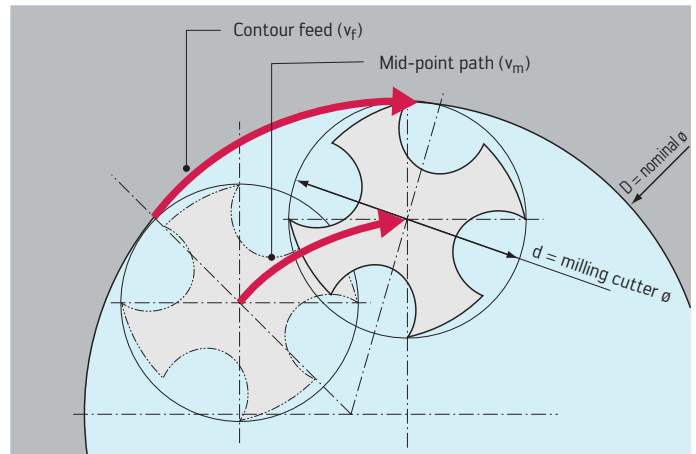

Thread milling calculation formulae

$$v_m = \frac{v_f (D-d)}{D}$$

k_c	Specific cutting force	N/mm ²
n	Speed	rpm
h	Thread pitch	mm
d_1	Nominal thread diameter	mm
P_{mot}	Drive power	kW
η_M	Machine efficiency (<1)	

Clamping systems for tools and tool adaptors

Tool adaptor DIN 69871 part 1 form B

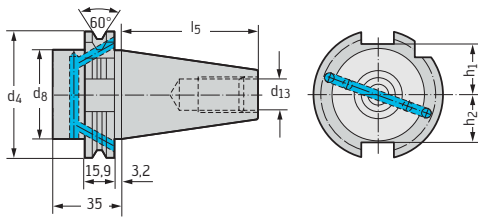

ISO no.	l ₅ mm	d ₄ mm	d ₈ max. mm	d ₁₃	h ₂ mm	h ₁ mm
40	68,40	63,55	50	M16	22,8	25,0
50	101,75	97,50	80	M24	35,5	37,7

(with internal coolant supply; dimensions similar to form A)

Tool adaptor ANSI B 5.50/CAT

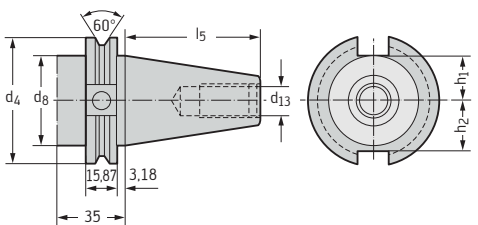

ISO no.	l ₅ mm	d ₄ mm	d ₈ mm	d ₁₃	h ₂ mm	h ₁ mm
40	68,25	63,5	44,5	M16	22,6	25,0
50	101,6	98,4	70,0	M24	35,3	37,7

(ANSI/ASME B 5.50 – 1885)

Tool adaptor MAS BT

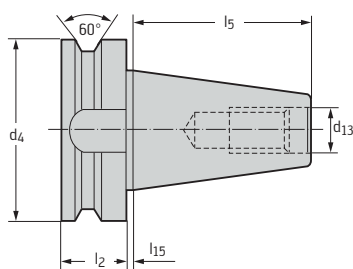

ISO no.	l ₅ mm	d ₄ mm	d ₁₃	l ₂ mm	l ₁₅ mm
40	65,4	63	M16	25	2
50	101,8	100	M24	35	3

Tool adaptor HSK DIN 69893, part 1, version A

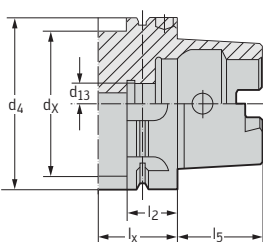

HSK	l ₅ mm	d ₄ mm	d _x max. mm	d ₁₃	l ₂ mm	l _x min. mm
63	32	63	53	M 18 × 1,0	26	42
100	50	100	85	M 24 × 1,5	29	45

Clamping systems for tools and tool adaptors

Parallel shank DIN 6535 HA / DIN 6535 HB		d_{11} h6 mm	l_5 +2 mm	b +0,05 mm	e -1 mm	b_2 +1 mm	h h11 mm
Form HA for $d_{11} = 6 - 20$ mm		6	36	4,2	18	-	5,1
		8	36	5,5	18	-	6,9
		10	40	7	20	-	8,5
		12	45	8	22,5	-	10,4
		14	45	8	22,5	-	12,7
		16	48	10	24	-	14,2
		18	48	10	24	-	16,2
		20	50	11	25	-	18,2
		25	56	12	32	17	23,0
Form HB for $d_{11} = 6 - 20$ mm							
Form HB for $d_{11} = 25$ mm							

Parallel shank DIN 6535 HE		d_{11} h6 mm	l_5 +2 mm	b -1 mm	e mm	h mm
for $d_{11} = 6-20$ mm		6	36	25	18	5,1
		8	36	25	18	6,9
		10	40	28	20	8,5
		12	45	33	22,5	10,4
		14	45	33	22,5	12,7
		16	48	36	24	14,2
		18	48	36	24	16,2
		20	50	38	25	18,2
		25	56	44	32	23,0
for $d_{11} = 25$ mm						

Clamping systems for tools and tool adaptors

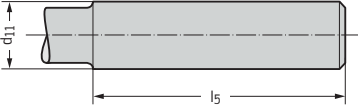
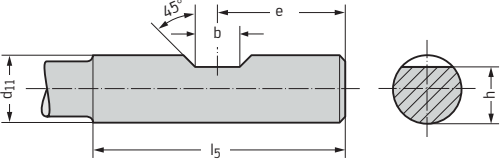
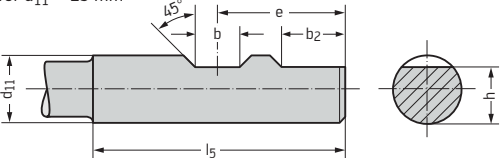
Parallel shank DIN 1835 A / DIN 1835 B		d_{11} h6 mm	l_5 +2 mm	b +0,05 mm	e -1 mm	b_2 +1 mm	h h13 mm
Form A for $d_{11} = 3 - 20$ mm		3	28	-	-	-	-
		4	28	-	-	-	-
		5	28	-	-	-	-
		6	36	4,2	18	-	4,8
		8	36	5,5	18	-	6,6
Form B for $d_{11} = 3 - 20$ mm		10	40	7	20	-	8,4
		12	45	8	22,5	-	10,4
		16	48	10	24	-	14,2
		20	50	11	25	-	18,2
		25	56	12	32	17	23,0
		32	60	14	36	19	30,0
Form B for $d_{11} = 25$ mm		40	70	14	40	19	38,0
		50	80	18	45	23	47,8

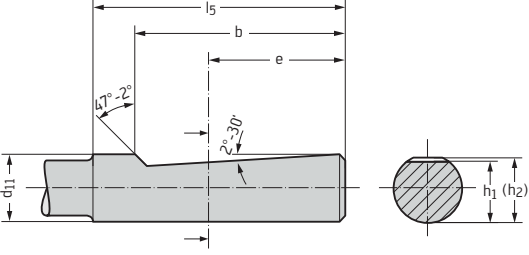
Parallel shank DIN 1835 E		d_{11} h6 mm	l_5 +2 mm	b -1 mm	e mm	h_1 mm	(h_2) h13 mm
Form E		6	36	25	18	5,4	4,8
		8	36	25	18	7,2	6,6
		10	40	28	20	9,1	8,4
		12	45	33	22,5	11,2	10,4
		16	48	36	24	15,0	14,2
		20	50	38	25	19,1	18,2
		25	56	44	32	24,1	23,0
		32	60	48	35	31,2	30,0

Clamping systems for tools and tool adaptors

Tool adaptor (MK) DIN 228 A

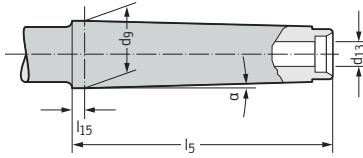

MK	d _g mm	l ₅ mm	l ₁₅ mm	α	d ₁₃
0	9,045	53	3	1°29'27"	-
1	12,065	57	3,5	1°25'43"	M6
2	17,780	69	5	1°25'50"	M10
3	23,825	86	5	1°26'16"	M12
4	31,267	109	6,5	1°29'15"	M16
5	44,399	136	6,5	1°30'26"	M20

Tool adaptor (MK) DIN 2207

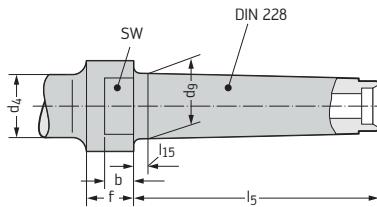

MK	d _g mm	l ₅ mm	l ₁₅ mm	d ₄ mm	f mm	b mm	SW d _g mm
3	23,825	86	5	36	18	12	24
4	31,267	109	6,5	43	23	15	32
5	44,399	136	6,5	60	28	18	45

Tool adaptor (SK) DIN 2080

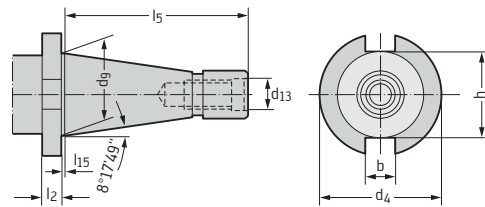

ISO no.	d _g mm	l ₅ mm	l ₁₅ ± 0,2 mm	d ₁₃	d ₄ - 0,4 mm	l ₂ ± 0,15 mm	b H12 mm	h max. mm
40	44,45	93,4	1,6	M16	63	10	16,1	45
50	69,85	126,8	3,2	M24	97,5	12	25,7	70,6

Tool adaptor (SK) DIN 69 871 part 1, form A

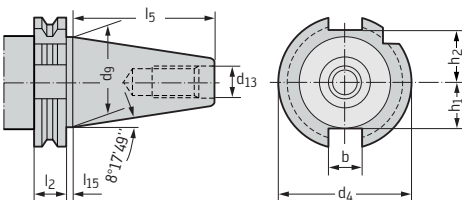

ISO no.	l ₅ - 0,3 mm	l ₂ - 0,1 mm	l ₁₅ ± 0,2 mm	d _g mm	d ₁₃	d ₄ - 0,1 mm	b H12 mm	h ₁ - 0,4 mm	h ₂ - 0,4 mm
40	68,4	15,9	3,2	44,45	M16	63,55	16,1	22,8	25,0
50	101,75	15,9	3,2	69,85	M24	97,50	25,7	35,5	37,7

Clamping systems for tools and tool adaptors

Parallel shank ISO 9766:1990 (E)

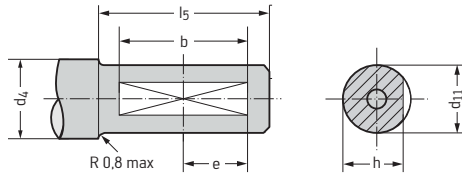

d_{11} h6 mm	d_4 min. mm	h h13 mm	l_5 ± 1 mm	e mm	b mm
20	25	18,2	50	14,5	29
25	31	23	56	17,5	35
32	38	30	60	19,5	39

Bore with longitudinal key way DIN 138 – A 10

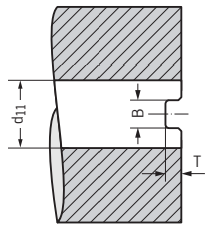

d_{11} mm	B H11 mm	T H12 mm
16	8,4	5,6
22	10,4	6,3
27	12,4	7
32	14,4	8
40	16,4	9

Bore with radial key way DIN 138 – L 10

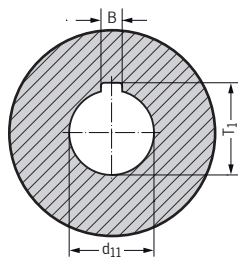

d_{11} H7 mm	B mm	T_1 mm
16	4	17,7
22	6	24,1
27	7	29,8
32	8	34,8
40	10	43,5
50	12	53,6
60	14	64,2

Tool adaptor Capto ISO 26623

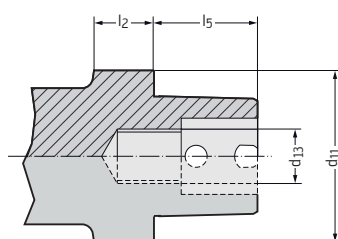

Type	d_{11} mm	l_2 mm	l_5 mm	d_{13}
Capto C3	32	15	19	M 12 × 1,5
Capto C4	40	20	24	M 14 × 1,5
Capto C5	50	20	30	M 16 × 1,5
Capto C6	63	22	38	M 20 × 2
Capto C8	80	30	48	M 20 × 2

Clamping systems for tools and tool adaptors

Tool adaptor ConeFit™

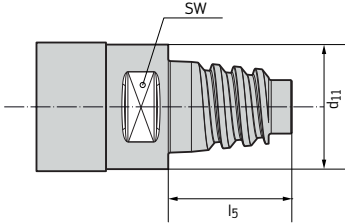

Type	d_{11} mm	l_5 mm	SW mm
E10	9,7	12,4	8
E12	11,7	14,5	10
E16	15,5	18,7	12
E20	19,3	21,3	16
E25	24,2	25,6	20

Tool adaptor ScrewFit

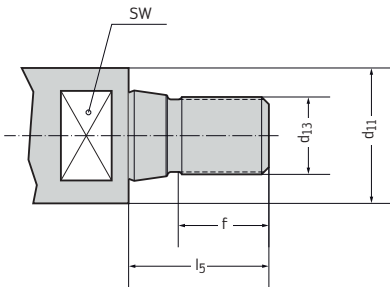

Type	d_{11} mm	d_{13}	l_5 mm	f mm	SW mm
T09	9,7	M5	14	6	8
T14	14,5	M8	18	10	12
T18	18,5	M10	21	12	14
T22	22	M12	23	14	17
T28	28	M16	29	18	21
T36	36	M20	35	20	30
T45	45	M20	35	20	36

Tool adaptor NCT

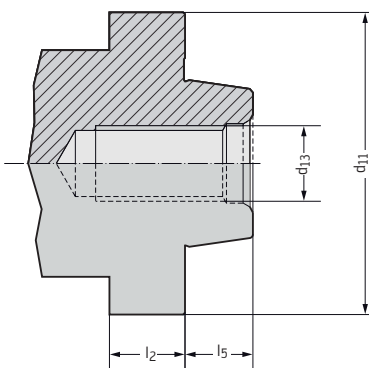

Type	d_{11} mm	d_{13}	l_5 mm	l_2 mm
25	24,85	M8	6,975	14
32	31,85	M8	6,975	14
40	39,85	M12	11,975	16
50	49,85	M12	11,975	16
63	62,85	M16	15,975	16
80	79,85	M20	17,975	18

Clamping systems for tools and tool adaptors

Bores with longitudinal key way for spindle head in acc. with DIN 2079 form B

	d_{11} mm	H_{11} mm	D_i mm	d_{1i} mm	d_{2i} mm	D_e mm	d_{1e} mm	d_{2e} mm	H mm	T mm	K mm	T_i mm	T_e mm
ISO 40/40 B	40	30	66,7	14	–	–	–	–	16,455	9,075	52,5	–	–
ISO 60/50 B	60	35	101,6	18	26	–	–	–	25,64	14,25	77,5	28	–
ISO 60/60-50 BB	60	35	101,6	18	26	177,8	22	33	25,64	14,25	122,5	28	32

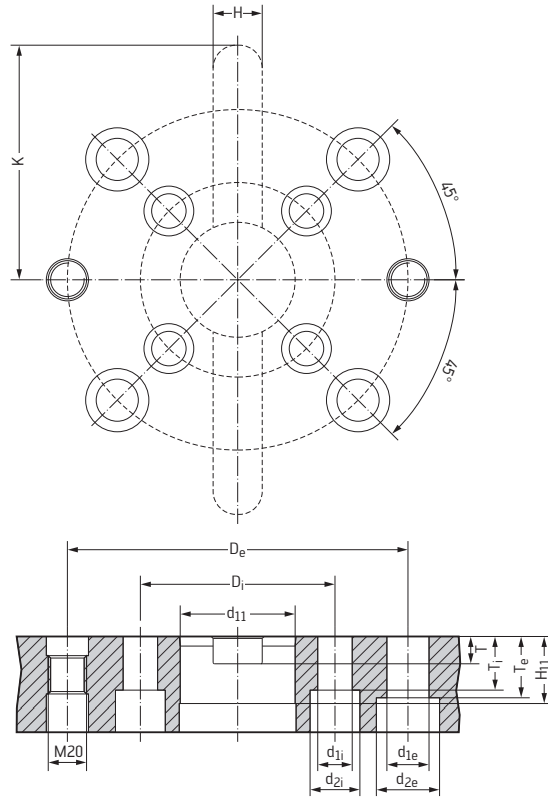
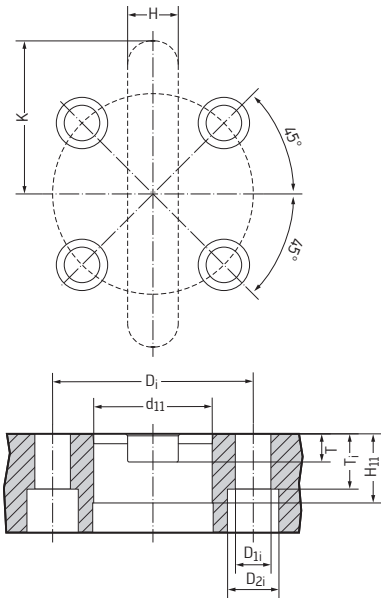

Alphanumeric Index

Designation	Page	Designation	Page	Designation	Page	Designation	Page
20160.....	D 65	2036035.....	D 50	2051062.....	D 98	2084805.....	D 68
20165.....	D 64	20361.....	D 79	20513.....	D 99	20890.....	D 66
20167.....	D 63	203611.....	D-47	2051306.....	D 99	20934.....	D 70
20200.....	D 45	2036115.....	D-47	2051315.....	D 103	20944.....	D 70
202061.....	D 57	2036155.....	D 82	2051332.....	D 101	20954.....	D 70
20207.....	D 266	20362.....	D 116	205135.....	D 99	21210.....	D 136
20210.....	D 43	20380.....	D 48	20516.....	D 111	2121305.....	D 141
202105.....	D 43	20390.....	D 49	20517.....	D 87	212161.....	D 144
20211.....	D 40	2039005.....	D 49	205173.....	D 92	2121763.....	D 145
20213.....	D 53	204069.....	D 271	205174.....	D 90	21263.....	D 141
2021306.....	D 53	204089.....	D 270	205175.....	D 87	2126305.....	D 141
202135.....	D 53	20410.....	D 83	205178.....	D 91	212661.....	D 144
202161.....	D 56	2041006.....	D 83	2051830.....	D 95	2126763.....	D 145
2021616.....	D 56	204101.....	D 119	2051832.....	D 95	21268.....	D 139
20217.....	D 51	2041014.....	D 120	20519.....	D 94	2128305.....	D 142
2021763.....	D 58	2041015.....	D 119	2051902.....	D 94	21311.....	D 150
20218.....	D 46	204102.....	D 117	205199.....	D 102	21360.....	D 137-D 138
20230.....	D 44	204104.....	D 118	2051995.....	D 102	2136005.....	D 137-D 138
202305.....	D 44	204105.....	D 83	20533.....	D 100	21361.....	D 151-D 152
20231.....	D 41	2041055.....	D 97	2053306.....	D 100	213611.....	D 155
20233.....	D 54	204107.....	D 86	20536.....	D 113	2136115.....	D-71
2023306.....	D 54	20410TR.....	D-48	20537.....	D 88	213614.....	D 154
20263.....	D 53	20411.....	D 42	2053705.....	D 88	21368.....	D 153
2026306.....	D 53	2041210.....	D 85	20547.....	D 89	21380.....	D 140
202635.....	D 53	2041215.....	D 85	2054705.....	D 89	2138005.....	D 140
202661.....	D 56	20415.....	D 112	20555.....	D 269	21410.....	D 156
20267.....	D 51	20416.....	D 121	205551.....	D 267	214101.....	D 172
2026763.....	D 58	2041606.....	D 121	205559.....	D 268	21416.....	D 173
20268.....	D 46	204164.....	D 122	205606.....	D 98	2141663.....	D 174
203031.....	D 264	2041663.....	D 123	2056062.....	D 98	21460.....	D 156
203039.....	D 265	20417.....	D 59	20563.....	D 99	2146005.....	D 156
20310.....	D 47	20430.....	D 84	2056306.....	D 99	2146006.....	D 156
2031006.....	D 47	20460.....	D 83	2056315.....	D 103	2146055.....	D 162
2031030.....	D 50	2046006.....	D 83	2056332.....	D 101	21460TR.....	D-72
2031035.....	D 50	204602.....	D 117	205635.....	D 99	21466.....	D 173
203105.....	D 47	204605.....	D 83	20566.....	D 111	2146663.....	D 174
20311.....	D 78	2046055.....	D 97	20567.....	D 87	21480.....	D 157
203111.....	D-47	204607.....	D 86	205673.....	D 92	2148005.....	D 157
2031115.....	D-47	20460TR.....	D-48	205675.....	D 87	21513.....	D 164
203115.....	D 78	20461.....	D 42	205678.....	D 91	2151305.....	D 164
20312.....	D 116	2046210.....	D 85	2056830.....	D 95	21517.....	D 158
20315.....	D 115	2046215.....	D 85	2056832.....	D 95	215551.....	D 272
20316.....	D 124	20466.....	D 121	20569.....	D 94	2156062.....	D 163
20330.....	D 48	2046606.....	D 121	2056902.....	D 94	21563.....	D 164
2033005.....	D 48	204664.....	D 122	205699.....	D 102	2156305.....	D 164
20340.....	D 49	2046663.....	D 123	2056995.....	D 102	2156315.....	D 166
2034005.....	D 49	20467.....	D 59	20587.....	D 88	21566.....	D 171
203531.....	D 264	20480.....	D 84	2058705.....	D 88	21567.....	D 158-D 159
20360.....	D 47	20505.....	D 269	20597.....	D 89	2156705.....	D 158-D 159
2036005.....	D 47	205051.....	D 267	2059705.....	D 89	21569.....	D 161
2036006.....	D 47	205059.....	D 268	20801.....	D 67	2158305.....	D 165
2036030.....	D 50	205106.....	D 98	20844.....	D 69	21587.....	D 160

■ = Supplementary catalogue contents

□ = Walter General catalogue 2012 contents

Alphanumeric Index

Designation	Page	Designation	Page	Designation	Page	Designation	Page
2158705.....	D 160	2321005.....	D 204	24361.....	D 238	7026050.....	D 289
22200.....	D 182	23213.....	D 207	243612.....	D 250	70263.....	D 292
22207.....	D 186	2321305.....	D 207	24460.....	D 239	7026300.....	D 292
222079.....	D 278	23217.....	D 209	245606.....	D 241	7026345.....	D 294
22210.....	D 181	23257.....	D 210	2456062.....	D 241	7026365.....	D 293
22213.....	D 184	232579.....	D 281	24563.....	D 242	70310.....	D 290
2221305.....	D 184	23263.....	D 208	2456305.....	D 242	7031003.....	D 290
22217.....	D 185	2326305.....	D 208	2456315.....	D 243	7031005.....	D 290
22257.....	D 186	23267.....	D 209	245660.....	D 246	7031006.....	D 290
22263.....	D 184	233031.....	D 279	24567.....	D 240	70311.....	D 296
2226305.....	D 184	233039.....	D 280	2456705.....	D 240	7031407.....	D 305
22267.....	D 185	233531.....	D 279	245699.....	D 244	703146.....	D 305
223031.....	D 273	23360.....	D 206	25167.....	D 251	70330.....	D 291
22310.....	D 183	2336005.....	D 206	25460.....	D 252	70360.....	D 290
2231005.....	D 183	233602.....	D 212	25467.....	D 253	7036003.....	D 290
22360.....	D 183	23400.....	D 216	255630.....	D 254	7036005.....	D 290
2236005.....	D 183	2340663.....	D 226	25567.....	D 255	7036006.....	D 290
22400.....	D 190	234069.....	D 286	2556702.....	D 255	70361.....	D 296
224069.....	D 277	234079.....	D 285	26167.....	D 256	70364.....	D 305
22410.....	D 189	23410.....	D 215	26460.....	D 257	7036407.....	D 305
224101.....	D 198	234101.....	D 223	26567.....	D 258	70380.....	D 291
224102.....	D 196	234104.....	D 222	265676.....	D 228	70410.....	D 297
224104.....	D 197	23416.....	D 224	27160.....	D 259	70460.....	D 297
22416.....	D 199	234164.....	D 225	28210.....	D 260	705130.....	D 301
224164.....	D 200	23450.....	D 216	28360.....	D 260	7051300.....	D 301
22450.....	D 190	234569.....	D 286	28517.....	D 261	7051305.....	D 301
22460.....	D 189	234579.....	D 285	28567.....	D 261	7051315.....	D 304
224602.....	D 196	23460.....	D 215	29100.....	D 262	7051365.....	D 302
224604.....	D 197	234604.....	D 222	29900.....	D 263	7051366.....	D 302
22466.....	D 199	23466.....	D 224	30016.....	D 62	7051503.....	D 303
224664.....	D 200	234664.....	D 225	30060.....	D 60	7051507.....	D 303
22505.....	D 276	23505.....	D 284	30063.....	D 61	705167.....	D 306
225051.....	D 274	235051.....	D 282	40310.....	D 52	705175.....	D 300
225059.....	D 275	235059.....	D 283	40311.....	D 80	7051770.....	D 298
22513.....	D 193	23513.....	D 219	40360.....	D 52	7051773.....	D 298
225135.....	D 193	235135.....	D 219	40517.....	D 93	7051775.....	D 298
22516.....	D 195	235170.....	D 217	40567.....	D 93	7051776.....	D 298
225170.....	D 191	2351705.....	D 217	60000.....	D 362	7053770.....	D 299
225174.....	D 192	23555.....	D 284	60003.....	D 363	705630.....	D 301
225532.....	D 229	235551.....	D 282	61000.....	D 364	7056300.....	D 301
22555.....	D 276	23563.....	D 220	62000.....	D 365	7056315.....	D 304
225559.....	D 275	235635.....	D 220	63000.....	D 366	7056365.....	D 302
22563.....	D 193	235670.....	D 218	64000.....	D 367	7056503.....	D 303
225632.....	D 230	2356705.....	D 218	70210.....	D 295	7056507.....	D 303
225635.....	D 193	235672.....	D 227	70211.....	D 288	70566.....	D 306
225670.....	D 191	24165.....	D 236	70213.....	D 292	705675.....	D 300
225674.....	D 192	24167.....	D 249	7021300.....	D 292	7056770.....	D 298
23200.....	D 205	24195.....	D 236	7021305.....	D 292	7056773.....	D 298
23207.....	D 210	24263.....	D 234	7021345.....	D 294	7056775.....	D 298
2320763.....	D 211	2426305.....	D 234	7021365.....	D 293	7056776.....	D 298
232079.....	D 281	24360.....	D 233	7021366.....	D 293	7058770.....	D 299
23210.....	D 204	2436005.....	D 233	70230.....	D 291	7126300.....	D 309

Alphanumeric Index

Designation	Page	Designation	Page	Designation	Page	Designation	Page
7126365.....	D 310	A		A1174.....	B 53	A3299XPL.....	B-33-B-36
71360.....	D 307–D 308	A...PCLN.....	A-104	A1174C.....	B 54	A331.....	G 98
7156300.....	D 312	A...PDUN.....	A-105	A120M.....	G 51	A3365TFT.....	B 73–B 76
7156365.....	D 313	A...PSKN.....	A-106	A1211.....	B 171–B 179	A3367.....	B 77–B 78
7156507.....	D 314	A...PTFN.....	A-107	A1211TIN.....	B 180–B 181	A3378TML.....	B 79–B 80
7156770.....	D 311	A...PWLN.....	A-108	A1212.....	B 182–B 184	A3379XPL.....	B-37-B-40
7426300.....	D 316	A...SCLC.....	A-109	A1222.....	B 185–B 189	A3382XPL.....	B 81–B 83
74360.....	D 315	A...SDUC.....	A-110	A1231.....	B 190–B 194	A3384.....	B 84
7456300.....	D 318	A...STFC.....	A-111	A1234.....	B 195–B 198	A3387.....	B 85
7456770.....	D 317	A...DCLN.....	A 164	A1244.....	B 199–B 203	A3389AML.....	B-41
8021006.....	D 71	A...DDUN.....	A 165	A1247.....	B 204–B 207	A3389DPL.....	B 86–B 88
8026006.....	D 71	A...DSKN.....	A 166	A1249TFL.....	B 208–B 211	A3393TTP.....	B-42-B-44
80311.....	D 130	A...DTFN.....	A 167	A1249XPL.....	B 212–B 215	A3399XPL.....	B-45-B-49
8031106.....	D 130	A...DVUN.....	A 168	A1254TFT.....	B 216–B 217	A340M.....	G 65
8031116.....	D 131	A...DWLN.....	A 169	A1263.....	B 55–B 56	A3486TIP.....	B 94
8031310.....	D 129	A...NTS-I.....	A 283	A1276TFL.....	B 57	A3487.....	B 95
803141.....	D 128	A...PVQB.....	A 184	A130M.....	G 52	A3586TIP.....	B 96
8031417.....	D 128	A...PVUB.....	A 182	A150M.....	G 53	A3687.....	B 97
8031806.....	D 132	A...SDQC.....	A 178	A1511.....	B 218–B 220	A3865TFL.....	B 98–B 101
8031906.....	D 133	A...SDUC...-X.....	A 177	A1522.....	B 221–B 224	A3879XPL.....	B-50-B-53
8036310.....	D 129	A...SSKC.....	A 179	A1544.....	B 225–B 226	A3885TFL.....	B 102–B 105
80410.....	D 126	A...SVQB.....	A 183	A1547.....	B 227–B 229	A3899XPL.....	B-54-B-57
8041006.....	D 126	A...SVUB.....	A 181	A1549TFP.....	B 230–B 231	A3965TFT.....	B 106–B 109
804101.....	D 127	A...SWLC.....	A 185	A155...HSK.....	G 88	A3967.....	B 110–B 111
8041056.....	D 125	A100M...HSK.....	G 87	A155.BT.....	G-30	A3979XPL.....	B-58-B-61
804601.....	D 127	A100M.1.....	G 42	A155.S.....	G-29	A3999XPL.....	B-62-B-65
8046056.....	D 125	A100M.2.....	G 43	A155M.....	G 54	A4211.....	B 247–B 254
8061106.....	D 349	A100M.3.....	G 44	A159.....	G-27	A4211TIN.....	B 255
8061716.....	D 350	A100M.4.....	G 45	A1622.....	B 232–B 234	A4244.....	B 256–B 257
8066716.....	D 350	A100M.8.....	G 47	A170...HSK.....	G 90	A4247.....	B 258–B 259
8121006.....	D 146	A101M.....	G 48	A170M.....	G 56	A4411.....	B 260–B 262
8126006.....	D 146	A102M.....	G 49	A170M...Ex.....	G 57	A4422.....	B 263–B 264
81311.....	D 178	A103M.....	G 50	A171...HSK.....	G 91	A4611.....	B 265–B 266
8136310.....	D 177	A1111.....	B 141–B 145	A1722.....	B 235	A4622.....	B 267
8136417.....	D 176	A1114.....	B 146	A175.....	G 58	A4722.....	B 268
8141056.....	D 175	A1114L.....	B 147	A1822.....	B 236	A510.....	G 68
8146056.....	D 175	A1114S.....	B 148	A1922L.....	B 237	A560.....	G 92
8166106.....	D 358	A1115.....	B 149	A1922S.....	B 238	A5971.....	B 116
8231106.....	D 201	A1115L.....	B 150	A201M.....	G 59	A6181AML.....	B-66
8331106.....	D 231	A1115S.....	B 151	A2258.....	B 239–B 242	A6181TFT.....	B 118
8431206.....	D 248	A1121.....	B 152	A2971.....	B 58	A6292TIN.....	B 269–B 270
		A1148.....	B 153–B 157	A305.....	G 63	A6478TML.....	B 119–B 120
		A1149TFL.....	B 158–B 162	A3143.....	B 243–B 244	A6488TML.....	B 121–B 122
		A1149XPL.....	B 163–B 167	A3153.....	B 245–B 246	A6489AMP.....	B-67
		A1154TFT.....	B 168–B 170	A3162.....	B 59–B 60	A6489DPP.....	B 123–B 125
		A1163.....	B 36–B 37	A320M.....	G 64	A6588TML.....	B 126
		A1164TIN.....	B 38–B 41	A3265TFL.....	B 61–B 64	A6589AMP.....	B-68
		A1166.....	B 42–B 45	A3269TFL.....	B 65	A6589DPP.....	B 127–B 129
		A1166TIN.....	B 46	A3279XPL.....	B-26-B-29	A6685TFP.....	B 130
		A1167A.....	B 47–B 49	A3285TFL.....	B 66–B 69	A6689AMP.....	B-69
		A1167B.....	B 50–B 52	A3289DPL.....	B 70–B 72	A6785TFP.....	B 131
				A3293TTP.....	B-30-B-32	A6789AMP.....	B-70

■ = Supplementary catalogue contents

□ = Walter General catalogue 2012 contents

Alphanumeric Index

Designation	Page	Designation	Page	Designation	Page	Designation	Page
A6794TFP	B 133			C...DCMN	A 151	C...STFC	A 196
A6885TFP	B 134			C...DDJN	A 123	C...STGC	A 145
A6889AMP	B-71			C...DDMN	A 152	C...SVHB	A 146
A6985TFP	B 136			C...DDUN	A 124, A 187	C...SVJB	A 146
A6989AMP	B-72			C...DSDN	A 126	C...SVMB	A 156
A6994TFP	B 137			C...DSKN	A 128	C...SVQB	A 197
A7191TFT	B 138			C...DSRN	A 127	C...SVVB	A 148
A7495TTP	B-73			C...DSSN	A 125	C...SWLC	A 150, A 199
ADGT	F-6			C...DVJN	A 129	C330	G 99-G 100
ADHT	F-7			C...DVMN	A 153	C340	G 101
ADKT	F-7			C...DWLN	A 130, A 188	CCGT	A 38-A 39
ADMT	F-7-F-9			C...MTJN	A 136	CCGT	C-19-C-20, C-25
AK135M	G-18			C...NC2000	G 12	CCGT	A-42-A-43
AK155...HSK	G 89			C...NC3000	G 12	CCMT	C-19-C-20, C-25-C-26
AK155.BT	G-32			C...NCAE	A 250	CCMT	A-42-A-43
AK155.S	G-31			C...NCBE	A 252	CCMW	C-26
AK155M	G 55			C...NCCE	A 256	CCMW	A-44, A-59
AK170.BT	G-34			C...NCDE	A 260	CNGG	A-15
AK170.S	G-33			C...NCEE	A 264	CNGN	A-56
AK180...HSK	G 93			C...NCFE	A 268	CNHQ	F-36
AK182.BT	G-36			C...NCFE-C	A 272	CNHU	F-36
AK182.H	G-28			C...NCHE	A 266	CNMA	A-19-A-20, A-56
AK182.S	G-35			C...NCLE	A 254	CNMG	A-15-A-18
AK200M.2	G 46			C...NCME	A 262	CNMM	A-20
AK300...HSK	G 94-G 95			C...NCNE	A 258	CNMQ	F-36
AK300.BT	G-38, G-40			C...NCOE	A 270	CNNU	F-36
AK300.S	G-37, G-39			C...NCOE-C	A 274	CPGT	C-26
AK300M	G 61-G 62			C...NTS-OE	A 282	CRDC	A-99
AK300T	G 60			C...NTS-OI	A 285	CRDN	A-98
AK500	G 67			C...NTS-SE	A 281	CRSN	A-97
AK510	G 68			C...NTS-SI	A 284		
AK512	G-19			C...PCLN	A 131, A 189		
AK520	G 69			C...PDJN	A 132		
AK521	G 70			C...PDUN	A 190		
AK522	G 70			C...PRDC	A 141		
AK523.T	G-24			C...PRSC	A 143		
AK530	G 71-G 72			C...PSKN	A 135, A 191		
AK531	G 73			C...PSRN	A 134		
AK540	G 74-G 75, G 77-G 78			C...PSSN	A 133		
AK541	G 76, G 79			C...PTFN	A 192		
AK580.C	G 80			C...PVHB	A 147		
AK600	G-17			C...PVJB	A 147		
AK610	G-25-G-26			C...PVQB	A 198		
AK631	G 83			C...PVVB	A 149		
AK641	G 84-G 85			C...PWLN	A 137, A 193		
AK681	G 86			C...SCLC	A 138, A 194		
				C...SCMC	A 154		
				C...SDJC	A 139		
				C...SDUC	A 195		
				C...SRDC	A 140, A 155		
				C...SRSC	A 142		
				C...SSRC	A 144		

Alphanumeric Index

Designation	Page	Designation	Page	Designation	Page	Designation	Page
DDHN.....	A 88	E2026382.....	D 39	E2251302.....	D 187	EP2058305.....	D-34
DDJN.....	A 87	E2028302.....	D 37	E2251312.....	D 188	EP2061105.....	D 330
DDNN.....	A 89	E2028305.....	D 37	E2256302.....	D 187	EP2061106.....	D 330
DNGG.....	A-21	E20314.....	D 106	E2256312.....	D 188	EP2061115.....	D 331
DNGN.....	A-57	E2031406.....	D 106	E2321302.....	D 202	EP2061116.....	D 331
DNMA.....	A-25, A-57	E2031416.....	D 109	E2321342.....	D 203	EP2061705.....	D 333
DNMG.....	A-21-A-25	E2031436.....	D 108	E2326302.....	D 202	EP2061706.....	D 333
DNMM.....	A-25	E2031446.....	D 110	E2326342.....	D 203	EP2061745.....	D 337
DP2061105.....	D 342	E2031466.....	D 107	E23314.....	D 221	EP2061746.....	D 337
DP2061705.....	D 345	E20364.....	D 106	E23364.....	D 221	EP2061805.....	D 334
DP2063105.....	D 343	E2036406.....	D 106	E2351302.....	D 213	EP2061806.....	D 334
DP2063705.....	D 346	E2036416.....	D 109	E2351312.....	D 214	EP2063105.....	D 332
DP2064105.....	D 344	E2036436.....	D 108	E2356302.....	D 213	EP2063106.....	D 332
DP2064705.....	D 347	E2036446.....	D 110	E2356312.....	D 214	EP2063705.....	D 335
DP2066105.....	D 342	E2036466.....	D 107	E2426302.....	D 232	EP2063706.....	D 335
DP2066705.....	D 345	E2051302.....	D 72	E24364.....	D 245	EP2063805.....	D 336
DP2068105.....	D 343	E2051305.....	D 72	E2436406.....	D 245	EP2063806.....	D 336
DP2068705.....	D 346	E2051312.....	D 74	E2456302.....	D 237	EP2066105.....	D 330
DP2069105.....	D 344	E2051342.....	D 75	E3111.....	B 285-B 286	EP2066106.....	D 330
DP2069705.....	D 347	E2051382.....	D 76	E6818.....	B 287	EP2066115.....	D 331
DP2161705.....	D 356	E2051802.....	D 77	E6819.....	B 288	EP2066116.....	D 331
DP2166705.....	D 356	E2051905.....	D 96	E6819TIN.....	B 289	EP2066705.....	D 333
DP2261705.....	D 359	E2053302.....	D 73	E7818.....	B 290	EP2066706.....	D 333
DP2266705.....	D 359	E2053305.....	D 73	E7819.....	B 291	EP2066745.....	D 337
DP2361705.....	D 360	E2056302.....	D 72	EB.....	C-58	EP2066746.....	D 337
DP2366705.....	D 360	E2056305.....	D 72	EP2021302.....	D-16	EP2066805.....	D 334
DP2466705.....	D 361	E2056312.....	D 74	EP2021305.....	D-16	EP2066806.....	D 334
DSBN.....	A 92	E2056342.....	D 75	EP2021342.....	D-18	EP2068105.....	D 332
DSDN.....	A-90	E2056382.....	D 76	EP2021382.....	D-19	EP2068106.....	D 332
DSKN.....	A 93	E2056802.....	D 77	EP2023302.....	D-17	EP2068705.....	D 335
DSSN.....	A-89	E2056905.....	D 96	EP2023305.....	D-17	EP2068706.....	D 335
DTGN.....	A 94	E2058302.....	D 73	EP2026302.....	D-16	EP2068805.....	D 336
DVJN.....	A 95	E2058305.....	D 73	EP2026305.....	D-16	EP2068806.....	D 336
DVPN.....	A-91	E2061305.....	D 338	EP2026342.....	D-18	EP2126302.....	D-56
DVWN.....	A 95	E2061604.....	D 339	EP2026382.....	D-19	EP2126342.....	D-57
DWLN.....	A-92	E2066305.....	D 338	EP2028302.....	D-17	EP2156302.....	D-65
		E2066604.....	D 339	EP2028305.....	D-17	EP2156312.....	D-67
		E2126302.....	D 134	EP2051302.....	D-33	EP2156362.....	D-66
		E2126342.....	D 135	EP2051305.....	D-33	EP2166115.....	D 351
		E21364.....	D 168	EP2051312.....	D-35	EP2166116.....	D 351
		E2136406.....	D 168	EP2051342.....	D-36	EP2166705.....	D 352
		E2136416.....	D 170	EP2051362.....	D-38	EP2166706.....	D 352
		E2136466.....	D 169	EP2051382.....	D-37	EP2166745.....	D 354
		E2156302.....	D 147	EP2053302.....	D-34	EP2166746.....	D 354
		E2156312.....	D 149	EP2053305.....	D-34	EP2168705.....	D 353
		E2156802.....	D 148	EP2056302.....	D-33	EP2168706.....	D 353
		E2221302.....	D 179	EP2056305.....	D-33	EP2221302.....	D-76
		E2221342.....	D 180	EP2056312.....	D-35	EP2226302.....	D-76
		E2226302.....	D 179	EP2056342.....	D-36	EP2251302.....	D-81
		E2226342.....	D 180	EP2056362.....	D-38	EP2251312.....	D-82
		E22314.....	D 194	EP2056382.....	D-37	EP2256302.....	D-81
		E22364.....	D 194	EP2058302.....	D-34	EP2256312.....	D-82

E

E...-SCLC.....	A-109
E...-SDUC.....	A-110
E...-STFC.....	A-111
E1111.....	B 284
E2021302.....	D 36
E2021305.....	D 36
E2021342.....	D 38
E2021382.....	D 39
E2023302.....	D 37
E2023305.....	D 37
E2026302.....	D 36
E2026305.....	D 36
E2026342.....	D 38

■ = Supplementary catalogue contents

□ = Walter General catalogue 2012 contents

Alphanumeric Index

Designation	Page
EP2321302	D-89
EP2326302	D-89
EP2351302	D-95
EP2351312	D-96
EP2356302	D-95
EP2356312	D-96
EP2426302	D-105
EP2456302	D-108

F

F1111	B 316
F1131	B 317–B 319
F1211	B 320
F1231	B 321
F1342	B 322–B 324
F1352	B 325–B 327
F1352HUN	B 329
F1353	B 330–B 331
F1362	B 332
F1371	B 333
F1375	E 53
F16	E 53–E 55
F2010	F-52
F2010	F 66–F 95
F2036	F 236
F2036M	F 236
F2139	F 214
F2146	F 96
F2162	B-92
F2171	B-93
F2231	F 216
F2232	F 238
F2233	F 98, F 100
F2234	F 218, F 220
F2235	F 102
F2237	F 174
F2238	F 176
F2238CE	F 178, F 182
F2238CK	F 180
F2239	F 226
F2239B	F 226
F2241	F 138–F 139
F2243	F 240
F2250	F 104, F 106
F2252	F 186–F 197
F2254	F 108
F2255	F 198
F2260	F 110
F2265	F 112
F2330	F 114
F2334	F 222, F 224

Designation	Page
F2334R	F-88
F2338	F 184
F2338F	F 160
F2339	F 228, F 230
F2481	B-94-B-95
F2481TMS	B-96-B-97
F2482	B-98-B-99
F2482TMS	B-100-B-101
F3040	F 140
F3234	B 334
F3317	B 335
F3517	B 336
F4030	F 116
F4031	F-90
F4033	F 118, F 120
F4038	F 162
F4041	F 142
F4042	F 144–F 147, F 152–F 159
F4042	F-68, F-70
F4042R	F 148–F 152
F4045	F-54, F-56
F4047	F 126
F4048	F 128
F4050	F-58, F-60, F-62
F4053	F 200–F 203
F4080	F 130–F 133
F4081	F 244
F4138	F 164
F4142	B 337
F4152	B 338–B 339
F4153	B 340
F4153	F 204, F 206
F4162	B 341
F4171	B 342
F4238	F 166
F4253	F 208, F 210
F4338	F 168
F4535	B 343
F4722	E 52
F4723	E 56
F4726	E 184
F5041	F-72
F5055	F-84
F5138	F-78
F5141	F-74
F5241	F-76
F6134	B 344
F7133	B 345
FR/FL670	C 138
FR/FL671	C 138
FR/FL672	C 140
FR/FL698	C 142

Designation	Page
FR/FL702	C 141
FR/FL704	C 141
FR/FL707	C 140
FR/FL709	C 144
FR/FL710	C 143
FR/FL711	C 144
FR/FL717	C 143
FR673	C 139
FR674	C 139
FR675	C 139
FR679	C 138
FR680	C 138
FR697	C 142
FR699	C 141
FR701	C 141
FR705	C 142
FR706	C 142
FX	A 65
FX	A-81

G

G1011	A-117
G1041	A 214
G1041C	A 215
G1042	A 213
G1111	A 230–A 231
G1511	A 208
G1521	A 208
G1551	A 209
G2012	A-118
G2042	A-119
GX	A-69-A-79

H

H1E0111	E-71
H1E01118	E-71
H1E01219	E-71
H1E12018	E-56
H1E58018	E-78
H1E58118	E-79
H1E58318	E-80
H1E58518	E-81
H1E92718	E-54
H2034217	E-42
H2038217	E-52
H2134217	E-42
H2138217	E-52
H2EC34217	E-41
H2EC38217	E-51
H2EC94717	E-53

Designation	Page
H3013018	E 91
H3013118	E 91
H3014018	E 92
H3014118	E 92
H3020117	E 140
H3020317	E 142
H3021117	E 84
H3021138	E 37
H3021178	E-43
H3021217	E 128
H3021317	E 86
H3021378	E-44
H3022018	E 42
H302211	E 43
H3022118	E 43
H3023018	E 93
H3023118	E 39
H3023138	E-13
H3023418	E 40
H3023518	E 41
H3024148	E 36
H302611	E 100
H3026118	E 100
H302711	E 101
H3027118	E 101
H302731	E 102
H3027318	E 102
H3027418	E 103
H3027419	E 104
H302914	E 94
H3029148	E 94
H3053918	E 221
H305811	E 218
H3058118	E 218
H305831	E 219
H3058318	E 219
H305851	E 220
H3058518	E 220
H3058917	E 44
H3068118	E 222
H3070118	E 147
H3070318	E 147–E 148
H3071118	E 90
H3071318	E 90
H3083017	E 172
H3090418	E 105
H3093418	E 45
H3094718	E 138
H3094728	E 139
H311501	E 129
H3115018	E 129
H3116018	E 129

Alphanumeric Index

Designation	Page	Designation	Page	Designation	Page	Designation	Page
H3117018	E 130	H4044928	E 163	H5287006	D-138	H8006428	E 202
H311801	E 130	H404691	E 206	H5287016	D-138	H800881	E 153
H3118018	E 130	H4046918	E 206	H528800	D 389	H8008818	E 153
H3120317	E 142	H4046919	E 207	H5288006	D 389	H800891	E 154
H3121217	E 128	H4046928	E 208	H5336006	D 381	H8008918	E 154
H3121317	E 86	H4046988	E-69-E-70	H5336016	D 381	H8011118	E 193
H3121378	E-44	H4120017	E 144	H5351116	D 383	H8014028	E 203
H3122018	E 42	H4120117	E 146	H538800	D 390	H8014128	E 204
H3122118	E 43	H4121017	E 87	H5388006	D 390	H8015728	E 155
H3123118	E 39	H4121078	E-45	H545200	D 384	H8015828	E 155
H3123418	E 40	H4121117	E 88	H5452006	D 384	H8016418	E 197
H3123518	E 41	H4121178	E-46	H5452106	D 384	H8016419	E 199
H312914	E 95	H4121217	E 89	H5452116	D 384	H8016428	E 202
H3129148	E 95	H4121278	E-47	H5551106	D 385	H8018718	E 50
H3158318	E 219	H4129318	E 149	H5651106	D 385	H8074128	E 203
H3158518	E 220	H4133217	E-40	H602091	E 158	H8082228	E 48
H3170318	E 148	H4134217	E-39	H602111	E 205	H8083128	E 38
H3171318	E 90	H4138217	E-49	H602311	E 150	H8095918	E 156
H3178128	E 46	H4180378	E 170	H6023114	E 150	H8095919	E 157
H3180278	E 170	H4189278	E 167	H602411	E 97	H8111118	E 193
H3182378	E 167	H4189378	E 167	H602511	E 97	H8E01118	E 192
H3183017	E 172	H4E34217	E-38	H602551	E 99	H8E11118	E 192
H3183378	E-59	H4E38217	E-48	H602641	E 107	H901411	E 106
H3185378	E 165	H5033008	D 370	H602681	E 107	H901451	E 106
H3186378	E-58	H5035016	D 371	H602691	E 159	HP8061106	D-130
H3187278	E 171	H5036006	D 372	H602881	E 160	HP8061716	D-131
H3E20317	E 141	H5036016	D 372	H6028818	E 160	HP8061816	D-132
H3E20419	E-55	H5041116	D 373	H608391	E 173	HP8166716	D-133
H3E21138	E 37	H5045016	D 380	H6083914	E 173		
H3E21317	E 85	H505500	D 378	H608411	E 168		
H3E23138	E-12	H5055006	D 378	H608771	E 168		
H3E29148	E 94	H505501	D 378	H608871	E 169		
H3E58118	E 218	H5055016	D 378	H618911	E 169		
H3E58318	E 219	H5055106	D 378	H6E2211	E 98		
H3E58518	E 220	H5055116	D 379	H6E2311	E 150		
H3E68118	E 222	H5075011	D 391	H6E2511	E 96		
H3E82378	E-57	H5075018	D 391	H7073417	E 49		
H3E85378	E 164	H5083008	D 386	H7073717	E 151		
H3E93718	E 137	H5087006	D 387	H800111	E 194		
H3E94718	E 137	H5087016	D-136	H8001118	E 194		
H4020017	E 143	H508800	D 388	H8001119	E 195		
H4020117	E 145	H5088006	D 388	H8001918	E 196		
H4021017	E 87	H5088016	D-137	H8001919	E 198		
H4021117	E 88	H5133008	D 370	H8004028	E 200		
H4021217	E 89	H5150106	D 376	H8004128	E 200		
H4033217	E-40	H515100	D 374	H8004728	E 201		
H4034217	E-39	H5151006	D 374	H8004788	E-68		
H4036217	E-50	H5151106	D 374	H8005728	E 152		
H4038217	E-49	H5151116	D 375	H8005828	E 163		
H404491	E 51	H515501	D 377	H8005928	E 152		
H4044918	E 51	H5155016	D 377	H8006418	E 197		
H4044919	E 162	H5251116	D 382	H8006419	E 199		

I

I12 A 245

K

K1111 B 292
 K1111TIN B 292
 K1112 B 293
 K1113 B 294
 K1113TIN B 295
 K1114 B 296
 K1131 B 297
 K1161 B-84
 K1161XPL B-85
 K1215 B 299
 K1311 B 300
 K1313 B 301
 K1411L B 302
 K1411M B 303
 K1411S B 304
 K1811 B 305
 K1911 B 306

Alphanumeric Index

Designation	Page	Designation	Page	Designation	Page	Designation	Page
P2231005	D-79	P2905	F-28	P313211	E 225	PSSC	C 135
P22360	D-79	P300611	E 113	P313231	E 225	PSSN	A-94
P2236005	D-79	P301612	E 114	P314101	E 224	PTFC	C 136
P22509	D-86	P301702	E 131	P314801	E 223	PTFN	C 132
P225099	D-121	P302201	E 116	P3148016	E 223	PTFN	A-96
P22519	D-85	P302211	E 118	P315801	E 227	PTGN	A-96
P22559	D-86	P302621	E 121	P315821	E 227	PVHB	A 118
P22569	D-85	P310611	E 113-E 114	P315831	E 228	PVJB	A 118
P23200	D-91	P3106117	E 113-E 114	P315851	E 228	PVVB	A 120
P23210	D-90	P311601	E 134	P316601	E 210	PWLN	A 107
P2321005	D-90	P3116017	E 134	P3166017	E 210		
P233009	D-123	P311602	E 133	P316611	E 211		
P233509	D-123	P3116027	E 133	P3166117	E 211		
P23360	D-92	P311612	E 115	P316881	E 226		
P2336005	D-92	P3116127	E 115	P3201	F-15		
P233602	D-94	P311701	E 132	P3204	F-15		
P235099	D-125	P3117017	E 132	P352011	E 182		
P23519	D-99	P311702	E 131-E 132	P40310	D-29		
P2351905	D-99	P3117027	E 131-E 132	P40360	D-29		
P2352	F-29	P311712	E 122	P40519	D-46		
P23522	F-29	P3117127	E 122	P40569	D-46		
P235599	D-125	P311722	E 123	P4110217	E 176		
P23569	D-99	P312001	E 177	P4117027	E 110		
P2356905	D-99	P3120017	E 177	P4406	F-41		
P235692	D-101	P312011	E 177	P44280	F-42		
P23696	F-30	P3120117	E 177	P44290	F-42		
P2372	F-29	P312021	E 175	P44462	F-41		
P24360	D-106	P3120217	E 175	P45420	F-43		
P2436005	D-106	P312028	E 175	P4840	C-12-C-13		
P24569	D-109	P3120287	E 175	P4841	C-12-C-13		
P2456905	D-109	P3120387	E 179	P602602	E 111		
P2553	F 41	P3120537	E 178	P602612	E 112		
P26315	F-14	P3120717	E 181	P612602	E 111		
P26316	F 20	P3120937	E 178	P612612	E 112		
P26325	F-14	P3121017	E 180	P632612	E 125		
P26335	F-14	P312111	E 180	P6500	C 35		
P26337	F-14	P312201	E 116-E 117	P8001	F-16		
P26339	F-14	P3122017	E 116-E 117	P8112017	E 212		
P26379	F-15	P312211	E 118-E 119	P811211	E 212		
P265676	D-102	P3122117	E 118-E 119	P950004	E 127		
P2792	F 46	P312221	E 120	P955054	E 127		
P28210	D-112	P3122317	E 120	PCBN	A 98		
P28360	D-112	P312301	E 108	PCKN	A 99		
P28467	C 18	P3123017	E 108	PCLN	C 130		
P28469	C 18	P3123087	E 174	PCLN	A-93		
P28475	C 18	P3123117	E 108	PCSN	A 99		
P28477	C 18	P312401	E 109	PDJN	A 100		
P28479	C 18	P312411	E 109	PRDC	A 112		
P28519	D-113	P312673	E 124	PRGC	A 114		
P28569	D-113	P312674	E 209	PSBN	A 103		
P2901	F-28	P312771	E 124	PSDN	A-95		
P2903	F-28	P3128417	E 179	PSKN	A 104, C 131		

R

S

Alphanumeric Index

Designation	Page	Designation	Page	Designation	Page	
S2056315	D 105	SPHT	F-20	V		
S2061305	D 340	SPHW	F-20, F-24	VBGT	A-52	
S2061306	D 340	SPHX	F-28	VBMT	A-52	
S2061345	D 341	SPJW	F-23	VBMW	A-61	
S2066305	D 340	SPKN	F-23	VCGT	A-52	
S2066306	D 340	SPKT	F-21	VCMT	A-52-A-53	
S2066345	D 341	SPMN	F-23	VCMW	A-53	
S2126302	D 143	SPMT	F-20, F-22	VNGG	A-36	
S2126305	D 143	SPMW	F-20, F-22	VNMA	A-36	
S2156302	D 167	SPNR	F 30	VNMG	A-36	
S2156305	D 167	SRDC	A 111	W		
S2166305	D 355	SRSC	A 113	WCGT	C-21, C-27-C-28	
S2166306	D 355	SSBC	A 115	WCGT	A-54-A-55	
S2426302	D 235	SSDC	A 115	WCMT	C-21, C-28	
S2456302	D 247	SSDCN	A 115	WCMT	A-54-A-55	
S9000631	G 96	SSKC	C 134	WCMW	C-28	
S9018350	G 97	SSSC	C 134-C 135	WNMA	A-41	
S9018351	G 97	STGC	A 116	WNMG	A-37-A-40	
S9200011	G 101	SVHB	A 117	WNMM	A-41	
SBN	A 217	SVJB	A 117	WOEX	C-15	
SCFC	C 133	SVVB	A 119	WOMX	C-15	
SCGT	A-49	SWFC	C 137	X		
SCLC	A 108, C 133	SWLC	A 121	XDGT	F-25	
SCMT	C-20	SX	A-80	XDMT	F-25	
SCMT	A-49	SX	F-43	XLC	A 216	
SCMW	A-49	T			XLCE	A 212
SDGT	F-21	T091	D 393	XLCF	A 212	
SDHC	A 109	T119	D 393	XLDE	A 210	
SDHW	F-20-F-21	T129	D 393	XLDE-C	A 211	
SDJC	A 109	T469	D 393	XNGX	F-34-F-35	
SDMT	F-21	T91	D 392	XNHF	F-33	
SDMW	F-21	TCGT	C-11	XNHX	F-35	
SDNC	A 110, A 139	TCGT	A-50-A-51	Z		
SEHT	F-21	TCMT	C-11	Z2311	G 66	
SEHW	F-21	TCMT	A-50-A-51	Z3213	B 346	
SEKN	F-22	TCMW	A 47	Z3216	B 346	
SEKR	F-22	TCMW	C 15	Z3218	B 347	
SEMN	F 28	TCMW	C-11	Z3218TIN	B 347	
SEMR	F-22	TCMW	A-51, A-60	Z3219	B 348	
SH	D 326	TNEF	F-32	Z3219TIN	B 348	
SNGN	A-58	TNMA	A-34-A-35, A-58	Z3515	B 349	
SNGX	F-30-F-32	TNMG	A-32-A-34	Z3516	B 349	
SNHQ	F-42	TNMM	A-35	Z3518	B 350	
SNHX	F-30	TPAW	F-24	Z3711TIN	B 350	
SNMA	A-29-A-30, A-58	TPJW	F-24	ZDGT	F-26	
SNMG	A-26-A-29	TTCGT	A 46-A 47			
SNMM	A-30-A-31					
SNMX	F-30, F-32					
SP	D 326					
SPFN	F-23					
SPFR	F-23					
SPGT	F-20-F-21, F-23					

 = Supplementary catalogue contents = Walter General catalogue 2012 contents



Walter Toolshop – Quick. Easy. Order.

The next generation Walter Toolshop is here – more convenience functions for registered users mean that selecting and ordering has become even easier.

- Fully integrated Walter TOOLSHOP
- 45,000 products can be ordered 24 hours a day
- Single sign-on: Simply register on the Walter website to use this function
- Fast and easy product search thanks to search function and filter
- A wide range of ordering options – via the ordering code, individual Excel files or directly from Walter GPS
- Use saved templates to order recurring requirements
- Product availability and stock levels can be seen at any time

www.walter-tools.com



Walter AG

Derendinger Straße 53, 72072 Tübingen
Postfach 2049, 72010 Tübingen
Germany

www.walter-tools.com

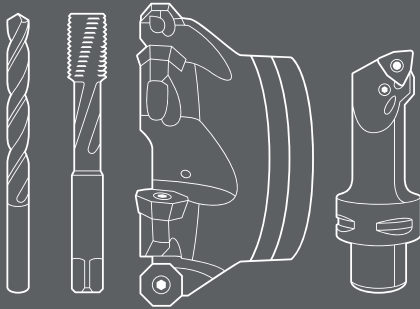

Walter GB Ltd.

Bromsgrove, England
+44 (1527) 839 450, service.uk@walter-tools.com

Walter Kesici Takımlar Sanayi ve Ticaret Ltd. Şti.

Istanbul, Türkiye
+90 (216) 528 1900 Pbx, service.tr@walter-tools.com

Walter Wuxi Co. Ltd.

Wuxi, Jiangsu, P.R. China
+86 (510) 8241 9399, service.cn@walter-tools.com

Walter AG Singapore Pte. Ltd.

+65 6773 6180, service.sg@walter-tools.com

Walter Korea Ltd.

Anyang-si Gyeonggi-do, Korea
+82 (31) 337 6100, service.kr@walter-tools.com

Walter Tools India Pvt. Ltd.

Pune, India
+91 (20) 3045 7300, service.in@walter-tools.com

Walter (Thailand) Co., Ltd.

Bangkok, 10120, Thailand
+66 2 687 0388, service.th@walter-tools.com

Walter Malaysia Sdn. Bhd.

Selangor D.E., Malaysia
+60 (3) 8023 7748, service.my@walter-tools.com

Walter Tooling Japan K.K.

Nagoya, Japan
+81 (52) 723 5800, service.jp@walter-tools.com

Walter USA, LLC

Waukesha WI, USA
+1 800-945-5554, service.us@walter-tools.com

Walter Canada

Mississauga, Canada
service.ca@walter-tools.com
